

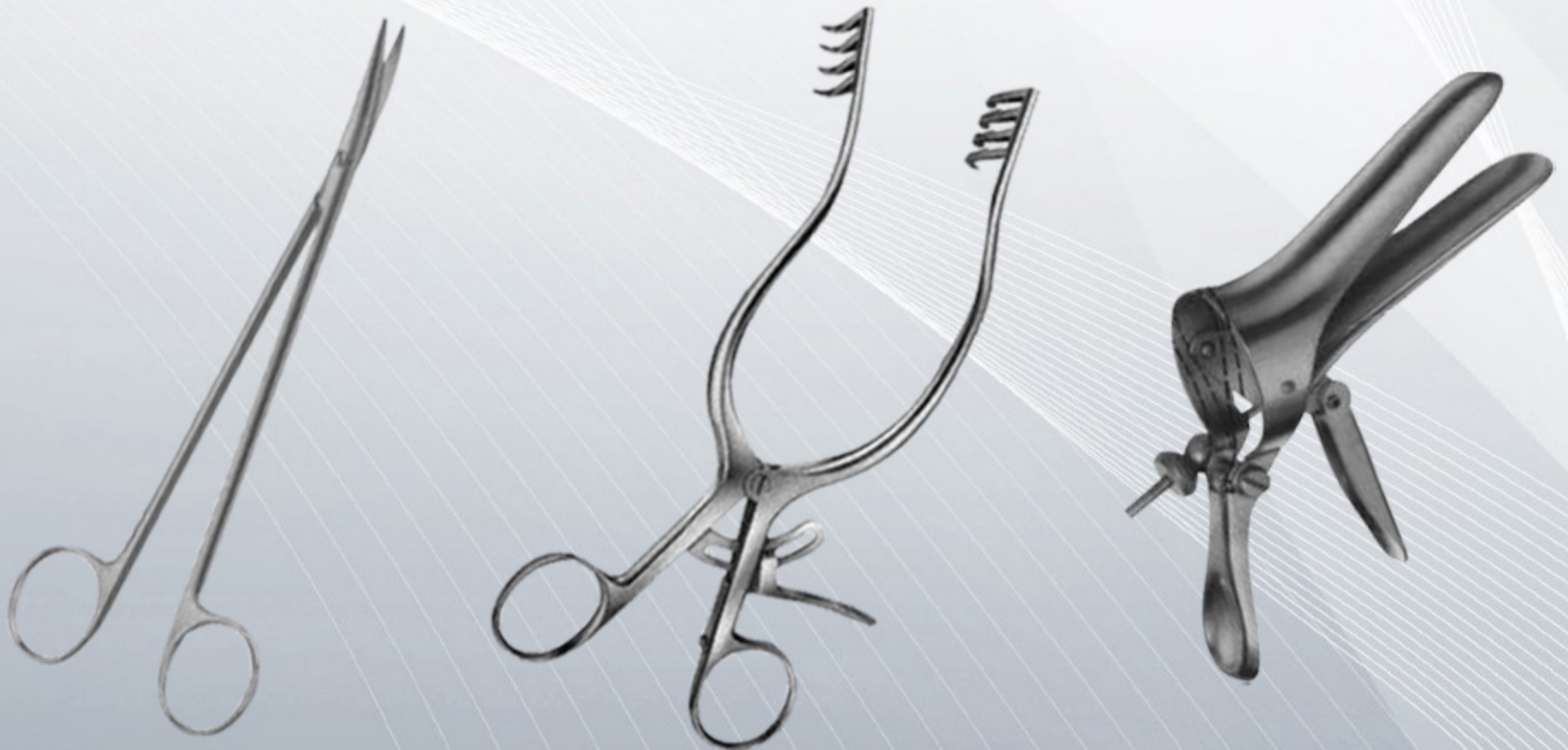

Tusk International
We Put Life in Metal

EDITION:
2016-2017



QUALITY AT PRICES

SURGICAL
INSTRUMENTS CATALOGUE

www.tuskint.com

GENTLEMEN

We feel honored and pleased to present our new catalogue which illustrates the most modern instruments and hope that this would serve as a good reference book to our worthy customers. Our new catalogue is a New Gift to the concerned professionals.

For the items not illustrated on our catalogues, we will accept drawings and even reference numbers with pictures from any catalogue of recognized organization worldwide.

Owing to fluctuation in wages and cost of material, it has not been possible to give prices on the catalogue. To supply this need, we propose to print a separate price list from time to time.

For some time now we have maintained a high standard of our products and are improving it further with the kind cooperation of our customers. We avail ourselves of this opportunity to assure our valuable customers for the superfine quality, competitive prices and prompt deliveries of our products.

In conclusion, we thank our friends for their valued support in the past and hope that this patronage will continue in further, for our mutual advantage.

Sincerely Yours,

Mr. Muhammad Amin
Mr. Kamran Amin
Mr. Zahid Maqsood

TUSK INTERNATIONAL

Key Personnel

Address: 24/477 Gawshala Circular Road, Sialkot 51310-Pakistan

Tel# +92-52-4570160

Fax # +92-52-4570160

Cell # +92-321-6167087

Website: <http://www.tuskint.com>

E-Mail: sales@tuskint.com / info@tuskint.com



COMPANY PROFILE

ABOUT US:

TUSK International seated in Sialkot-Pakistan manufactures and exports premium quality instruments for all medical professionals around the world. We have huge experience since last TWO GENERATIONS involved in the manufacturing of medical instruments. It is our FAMILY BUSINESS since the year 1965.

FIRST GENERATION:

Mr. Muhammad Amin was born in a respectable family and laid down the foundation of a small factory in the year 1965 after completely skilled. He started to manufacture Dental Instruments initially such as Extracting Forceps and Pliers. Our quality instruments gained the fame in local industry and we expanded the range of our instruments by adding Forceps and Scissors of all kinds. Our local customers in Sialkot demanded more and more from us since their foreign customers liked the quality of our instruments. Main names/Major companies of the Sialkot city were used to export our manufactured quality instruments to all over the world and achieved great appreciations. Upon their rising demands, we added other instruments to our range such as Root Elevators, Scalars, Needle Holders, General Surgical, Orthopedic, ENT and Gynecology etc. etc. We served the local industry for 30-35 years.

SECOND GENERATION:

Mr. Kamran Amin joined his father (Mr. Muhammad Amin) and feels the necessity to serve the overseas customers with quality Dental and Surgical instruments. Hence, he established a sole proprietorship company in the year 2000 under the title of TUSK International for the manufacturing and export of all variety of Dental, Orthodontic and Surgical instruments to all over the world. Experience of FIRST GENERATION really gave an edge over others in terms of best quality at most competitive prices with short delivery schedules. He made a team of experts and worked hard for the enrichment and expansion of business throughout the world. A target had been set by him to achieve the reputation in international market to accomplish his ideas. He successfully expanded the export market to Vietnam, India, Mozambique and other African countries, that still continue.

CERTIFICATIONS:

TUSK International is export registered firm with Government of Pakistan and certified for ISO 9001:2008, ISO 13485:2003, achieved CE Mark for class-I Medical Devices and FDA-cGMP Incompliance Company.

AFFILIATIONS:

Member of Sialkot Chamber of Commerce & Industry
Members of Surgical Instruments Manufacturers Association of Pakistan

PORTFOLIO & KEY POINTS TO SUCCESS:

TUSK International offers comprehensive range on all kinds of Dental, Orthodontic and Surgical Instruments. Sterilizing cassettes, Bur Holders, Boxes and Dental Luxators are also in our portfolio. We are fully competent to make any kind of medical instruments upon receipt of pictures, drawings and master samples from our worthy clients.

Our instruments are made of high and suitable composition of stainless steel from AISI 300 and AISI 400 series imported from Japan, France, Germany and Sweden. We use the Right material for the Right products. We also make customized products and never compromise on the quality of raw material.

By the virtue of Management Commitment, employee's dedication, skill and expertise, innovation and edge of modern technology, TUSK International continuously stepped forward and appeared as an icon of quality on the desktop of Dental, Surgical and Orthodontic Industry.

TUSK International believes in providing products with the best quality workmanship, highest standards of service and competitive prices with on time delivery, good working condition, fair wages and respect for the environment. The primary basis for the success of any product is its ability to satisfy the purpose for which it is manufactured. We observe delivery schedules strictly. Our prices are rational and most competitive.

We always discourage child labor and participate in efforts to eliminate child labor from the third world manufacturing countries.

TUSK International gained valuable knowledge after working many years closely with the Instrumentation Industry. Our staffs have a united background of over many years experience in the industry. This experience allows us to provide our customers with best quality instruments and vast knowledge of products, care, handling and maintenance.

It's always been our endeavor to maintain a high standard of production, quality control and customer satisfaction. We finally offer our sincere regard and gratitude to all our valued clients for patronizing TUSK International and helping us to achieve our basic target/goal.

QUALITY POLICY:

In TUSK International, quality means customer's satisfaction for all of us and we never compromise on it. That is why TUSK International is moving towards its great success day by day.

Our mission is not only to provide the highest quality goods and services to the medical professionals, but to establish a partnership with our customers. Through this partnership, we make it our goal to achieve 100% customer satisfaction. We are maintaining the International standards in accordance with the requirements of end user of our premium quality products.

We strongly believe in hardworking, honesty and truth in every commitment. TUSK International is working really hard to manufacture premium quality instruments from the concerned skilled professionals using the modern machinery and techniques with exact high class basic material to provide quality instruments to its valued customers since customer's satisfaction is always our number 1 priority.

TUSK International providing an atmosphere in which employees have the opportunity to realize their professional and personal goals results in a unified commitment to quality, integrity, and value for our customers.

QUALITY CERTIFICATE:

This is to certify that all the instruments at TUSK International are manufactured from the imported stainless steel according to the ASTM standards and under the requirements of customers. All the instruments are best in quality, accurate in performance. Our products have excellent reputation world-wide and providing satisfaction to the user.

GUARANTEE:

Now days challenging health care environment, investing in Medical Devices is a significant step to control cost and humanizing patient care. Our instruments are being manufactured with ultimate care and keeping in view the value of Human Life, therefore, 100% guaranteed with conformity to internationally recognized standards.

MESSAGE:

Quality is not a result of an accident. But, it is sincerely achieved through efforts, hard work, devotion and dedication to the human care with long time experience. Last but not least, we put life in metal. Of course, we believe in Almighty ALLAH at any stage. We fully hope you will appreciate our efforts and we believe on improvement. Your valued suggestions to the improvement would be highly appreciated by us!

With Heartiest Regards,

TUSK INTERNATIONAL

Key Personnel

Address: 24/477Gawshala Circular Road, Sialkot 51310-Pakistan

Tel# +92-52-4570160

Fax # +92-52-4570160

Cell # +92-321-6167087

Website: <http://www.tuskint.com>

E-Mail: sales@tuskint.com / info@tuskint.com

TERMS & CONDITIONS

Samples:

We are open to send samples for the purpose of quality evaluation. It will be free of cost in case of limited quantities.

Quotations:

We like to quote upon receipt of inquiries. After that, the quoted prices can be fixed for each item from time to time. Our quotations are without any obligation. All the agreements are acceptable in writing. Our offered prices are generally on ex-factory basis.

Purchase Orders:

To avoid any inconvenience, exact details and specifications are required for the items to be ordered. We prefer our catalogues while selection of items to be ordered. In other case, our valued customers are open to send pictures from any catalogue along with codes on the purchase order. Drawings and master samples are also accepted by us.

Proforma invoice/Order Confirmation:

We send Proforma invoice to our valued customers after receipt of confirmed purchase order. Our Proforma invoice includes all the terms and conditions such as stamping/marketing, packing, type of finish, our bank details, payment terms and lead time for the final confirmation by our valued customers.

Payment terms:

- 100% Advance Payment before starting production of goods after final confirmation of order.
- 50% Advance Payment after final confirmation of order and 50% before final dispatch of goods.
- Irrevocable Letter of Credit established through bankers (At Sight).

Delivery Time:

It usually depends upon number of items and volume of order. Our general Delivery Time is 4-6 weeks for normal orders and 6-8 weeks for bulk orders.

Minimum Order Quantity (MOQ):

It depends on case to case for the set up of mutual business relations. We always accommodate our valued business partners at any cost. We treat our loved customers as our friends. However, our production department prefers MOQ for 25 pieces of each item to complete the production process of batch smoothly.

Stamping/Marking & Packing:

We mark the instruments with our name and logo (TUSK brand) with the addition of stainless steel CE and date code. Marking is done by etching. Laser engraving is also available on small amount of extra charges. We also do the special marking according to the demand of our valued customers such as any name/brand/logo etc.

We normally pack the goods in Polyethylene bags. Customized packaging is available at small amount of extra charges upon special requirement of our valued customers.

Type of Finish:

Our valued customers need to specify the type of finish for the surface of instruments along with an order. Otherwise, our routine finish is bright or dull/satin.

Shipping/Delivery Address:

Complete shipping address along with telephone numbers is required along with purchase order to put the same on Proforma invoice/order confirmation for the final confirmation to avoid any mishap or delay while shipping the goods.

Shipments:

We recommend shipping the goods by our forwarders. In case of any nomination, the nominated agent will be responsible for the safe and secure delivery of goods. In case of ex-factory based shipments, our valued customers will be responsible to pay all the local charges at our end (shipper's end) such as customs clearance and transportation etc.

We will be responsible to pay the freight charges and all other local charges at our end in case of FOB, CNF and CIF deliveries. All the details such as weight, dimensions and number of cartons to be given by us before final dispatch, are approximate.

Price Increment:

We have the right to increase the prices by sending prior notice to our valuable customers. It becomes necessary when the cost of raw material is increased sufficiently; labor charges and all other overhead charges are increased adequately.

Return Policy:

TUSK International is aware of the facts and unforeseen event occurred in different parts like workmanship and standards. We do care your money as we care your health. All merchandise must have prior approval before being returned to us. TUSK International reserves the right to evaluate the condition of all returns.

MANUFACTURING PROCESSES

Forging:

We have our own forging section where forgings for proper instruments/devices are made through Drop Forging Hammers by qualified & skilled workers using Dyes made of the best-quality D-2 Steel. The forgings later are put through the process of overall /ring trimming, and acid cleaning / pickling by those well versed in these processes.

Milling/Machining:

Our Milling/Machining section have best quality and imported Milling/Grinding Machines which are operated by the well-trained experts for good milling of the Scissors, ratchets, serration teeth, box cutting, and for all other related processes to ensure exact perfection before filing. Top quality cutters are used for it. The process of filing is carried out again by the trained professionals to ensure high standard of exactitude and precision.

Heat Treatment:

We have our own (Vacuum Furnace) Heat Treatment Department where qualified & trained staffs are engaged to give treatment to instruments for furtherance of quality.

Electro-Polishing & Grinding:

The Electro-Polishing and the Grinding Departments are also manned by skilled & trained workmen using the imported chemicals and the grinding wheels to ensure the best-quality finish.

Tungsten Carbide Inserts:

Our T.C. inserts Department is installed with the best-quality imported machinery being manned by the exceptionally well-trained experts using the German Technology.

Passivation:

We passivate and boil test each and every instrument before packing, subjecting every piece to 24-hour treatment using the top-quality imported chemical in our Passivation Department. To eliminate any chances of rusting / Corrosion etc, we do the Re-Passivation if required.

Sandblasting:

We use the machines for sandblasting as well as the best quality sandblasting materials which are operated by skilled & well trained operators.

Stamping/Etching:

The Stamping /Etching process is carried out by the soundly trained experts to match the world standards.



HANDLING & CARE OF INSTRUMENTS

BASIC METHODS FOR HANDLING & CARE OF INSTRUMENTS CLEANING, STERILIZATION & MAINTENANCE OF SURGICAL INSTRUMENTS:

New instruments should be cleaned, dried and sterilized before the first use.

1. CAGE IN/PRE-BATHE

It is important never to hold instruments in a dry container, which allows blood and waste to dry onto instrument surfaces and makes cleaning more difficult. If rinsing and decontamination processes are not immediately available, pre-treat instruments or hold in a neutral holding/pre-bathe enzymatic solution after patient use but before actual cleaning. Prep Enzyme Foaming spray for pre-cleaning of dirty instruments and scopes. Simply spray on instruments until ready for rinsing and disinfection. Also, use neutral pH all purpose multi-enzyme concentrate is ideal for instrument presoaking and pre-cleaning. As soon as possible, rinse, disinfect and clean as follows:

2. RINSING

Immediately, remove organic materials by rinsing instruments under warm (not hot) running water after surgery. Rinse should remove most blood fluids and tissue. Do not process metals (stainless, copper, chrome plated, etc.) together. Always wear safety protection gear.

3. DISINFECTING

To protect medical personnel from contamination during cleaning, immerse instruments completely in an EPA approved disinfectant for approximately 10-20 minutes. Always closely follow manufacturers' recommended disinfecting time and solution preparation and instruction. Then rinse again.

CAUTION:

Disinfected instruments are NOT STERILE. Never expose stainless steel instruments to bleach or other corrosive chemicals to disinfect. Exposure to bleach may result in instruments pitting and will cancel all guarantees by the manufacturer.

4. CLEANING

All blood dried body fluids and should be completely removed from the instruments prior to sterilization. Several methods are available.

A. Bathe: An enzymatic cleaner bath (soak) or a solution of water and neutral pH (7) detergent are effective in removing organic material from instruments. Use distilled (demineralized) water if possible. Instruments should be fully submerged for at least 10 minutes. Do not let "sharp" (scissors, knives, osteotomes, etc.) running water to remove solution. Change solutions frequently.

B. Ultrasonic Cleaning: Most instruments manufacturers recommend ultrasonic cleaning as the most effective way to clean surgical instruments, particularly those with hinges, box locks and other moving parts. All instruments must be fully submerged in open position. Use distilled (demineralized) water if possible. Make sure that "sharp" blades do not touch other instruments to prevent possible surface scratching and also be sure dissimilar metal instruments are separated. Process instruments for full recommended ultrasonic cleaning cycle. Change solution frequently or as often as the manufacturers recommends. Rinse instruments with water to remove the cleaning solution, can be safely use with all ultrasonic unites.

C. Automatic Washer sterilizer: Follow manufacturers' recommendations but ensure instruments are lubricated after the last rinse cycle and before the sterilization cycle.

CAUTION:

- Needle holder and forceps may check if sterilized with ratchet in closed position. Manual Cleaning: if ultrasonic cleaning is not available, observe the following steps.
- Use stiff nylon cleaning brushes. Do not use steel wool or wire brushes except specially recommended stainless steel wire brushes for instruments serrated areas, bone or on stained areas of knurled handles.
- Use only neutral pH (7) detergents such. If not rinsed off properly, low pH (acidic – less than 6 pH) detergents break down the stainless protective surface resulting in pitting and/or back staining. High pH detergents (alkaline – more than 8 pH) which can also interfere with the smooth operation of instruments. Most brown stains are not rust and are easily removed with stain remover. • Brush delicate instruments carefully, and if possible, separate them from general instruments.

- Make sure instruments surfaces are visibly clean and free from stain and tissue. Stain Remover can help remove residue stains. This is also a good time to inspect each instrument for proper function and condition.
- Check scissors' blades to ensure proper function. Blades should glide open and closed smoothly. Test cutting performance at $\frac{3}{4}$ length of the blade with the following recommended materials. Scissors should cut all the tips. Recommended cutting test materials:
 - Fine/Delicate scissors: Surgical gloves
 - Medium scissors: Single layer of stocking/cast netting
 - Large/utility scissors: Double layer of stocking/cast netting.
- Check forceps (pickups) for proper jaw alignment. Teeth must meet properly – without catching.
- Check hemostats and needle holders to ensure jaw tips close in first ratchet position and entire jaw should close in third ratchet position. Check instruments for loose hinges and verify that they lock and unlock easily.
- Suction tube should be clean inside.
- Test Biopsy Punches by punching a clean hole in 3-6 mil thick poly-bag material. If poly-bag material is not available, use tissue paper.
- Retractors should function properly.
- Cutting edge instruments and knives should be sharp and free of damage.
- After scrubbing, rinse instruments thoroughly under running water. While rinsing, open and close scissors, hemostats, needle holder and other hinged instruments to make sure the hinge areas are rinsed out and no waste remains.

5. AFTER CLEANING

Separate dissimilar metals prior to sterilizing/autoclaving. If instruments are to be stored, let them air-dry and store them in a clean and dry environment.

6. AUTOCLAVING

A. Lubricate all hinged instruments which have any "metal to metal" action, at the screw or box lock.

A non-silicone, water-soluble surgical lubricant is recommended. Do not use industrial oils and lubricants.

B. Sterilizer instruments either individually or in sets.

Individual Instruments: Disposable paper or plastic pouches are ideal. Make sure to use a wide enough pouch for instruments with ratchet locks so instruments can be sterilized in an open (unlocked) position. Instruments locked during autoclaving can experience cracked hinges (box lock) or other problems because of heat expansion. If wrapping instruments, make sure the towel does not contain detergent residue, which can stain instruments.

Instruments Sets: Unlock all instruments and sterilize in an open position. Place heavy instruments on the bottom of sets (when two layers are required). Do not overload the chamber because an air pocket may form that hinders steam penetration.

CAUTION:

With most portable tabletop autoclaves, at the end of the autoclave cycle and before the drying cycle, unlock the door and open it no more than crack, about $\frac{1}{4}$ " (6.4mm). Then run the dry cycle for the period recommended by the autoclave manufacturer. If the autoclave door is fully opened before the drying cycle, cold room air will rush into the chamber causing condensation on the instruments that may result in water stains or cause wet packs. Make sure autoclave filters and chambers are cleaned as recommended by the manufacturer.

Stain Remover is effective in removing stains and cleaning the autoclave chamber.

7. CHEMICAL/COLD STERILIZATION

Most chemicals/cold sterilization solution renders instruments sterile only after 10- hour immersion. This prolonged chemical action can be more detrimental than usual 20-minute autoclave cycle. If the instruments need to be "disinfected" only, a chemical/cold sterilization soak is acceptable, as disinfection in using bleach (paragraph 3).

Sterile- an absolute term (no living Organism survives)

Disinfected-basically clean. Some organisms may survive.

Always use the proper sterilization/cleaning technique to render the instruments in the required condition for use.

CAUTION:

For instruments with tungsten carbide inserts jaws, we do not recommended use of chemicals/cold sterilization solution, which may deteriorate the instrument's jaw. Delicate instruments and Mouth Mirrors should be cleaned by hand. Do not use ultrasonic cleaning machines.

TABLE OF CONTENTS:

**SECTION
01**

Scalpels

Page 01-09

**SECTION
02**

Scissors

Page 10-57

**SECTION
03**

Forceps

Page 58-71

**SECTION
04**

Needle Holders

Page 72-97

**SECTION
05**

Probes

Page 98-102

**SECTION
06**

Retractors

Page 103-159



TABLE OF CONTENTS:

**SECTION
07**

Liver, Gall Bladders
Kidney & Urology

Page 164-174

**SECTION
08**

Cotton Swap
Forceps etc.

Page 175-183

**SECTION
09**

Stomach, Intestines,
Rectum

Page 184-214

**SECTION
10**

Artery Forceps

Page 215-254

**SECTION
11**

Obstetrics

Page 255-261

**SECTION
12**

Dressings

Page 262-268

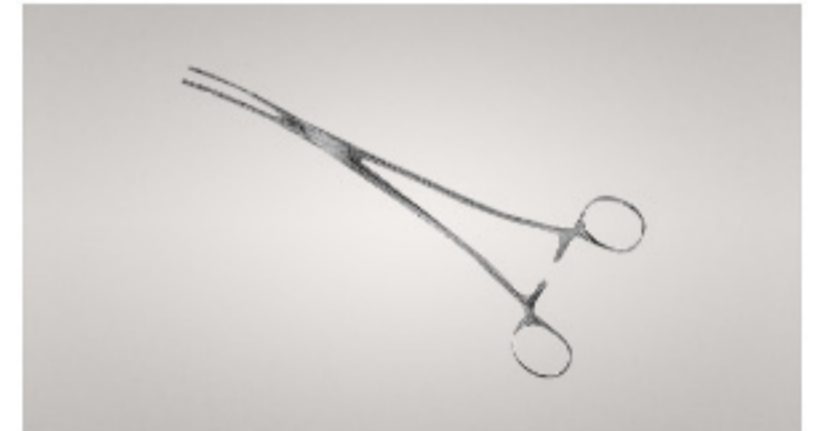
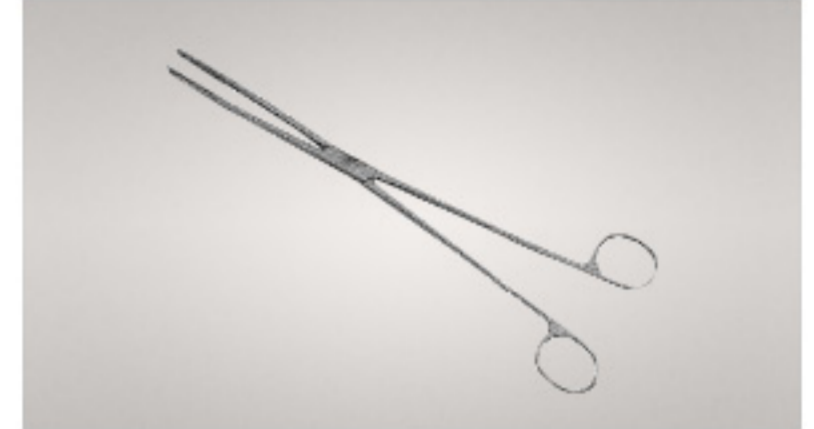
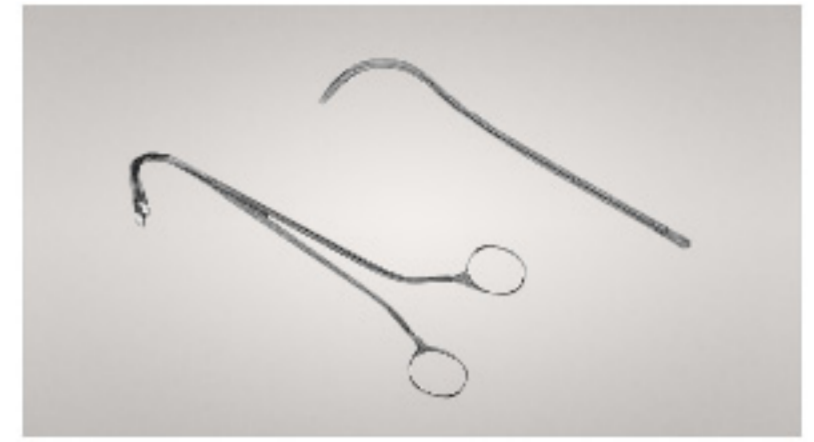

TABLE OF CONTENTS:

**SECTION
13**

**Otology and
Rhinology**

Page 269-292

**SECTION
14**

Gynecology

Page 293-326

**SECTION
15**

**Neurosurgery,
Laminectomy**

Page 327-376

**SECTION
16**

**Oral Maxillo-Facial
Surgery**

Page 377-404

**SECTION
17**

Bone Surgery

Page 405-497

**SECTION
18**

**Cardiovascular
Surgery**

Page 498-553

**SECTION
19**

Suction Tubes

Page 554-564

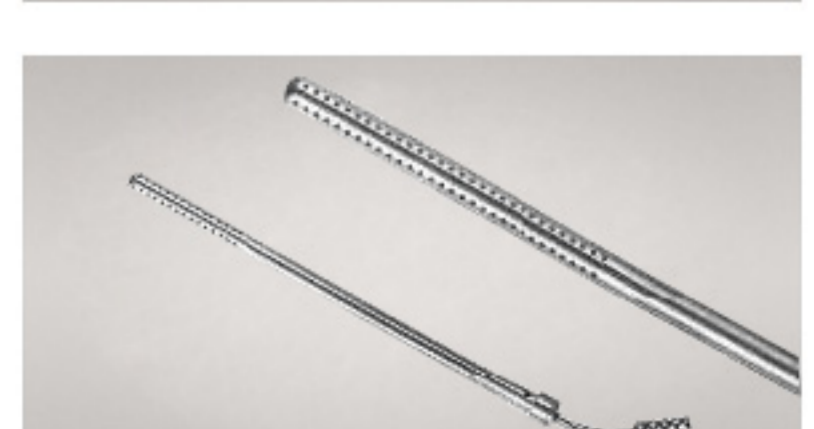
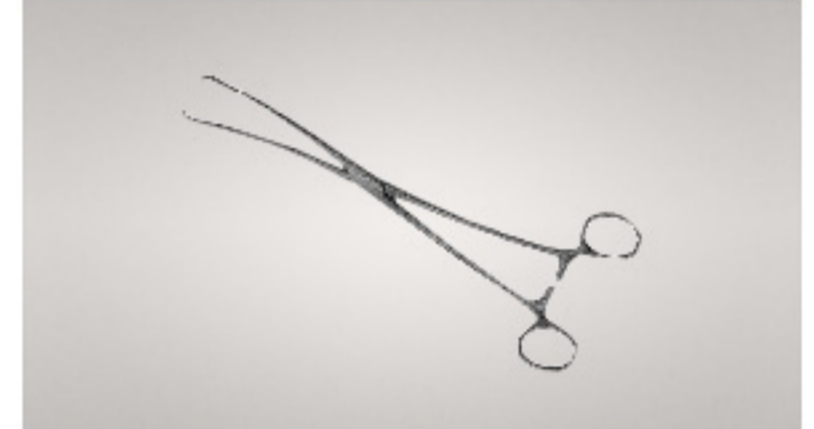

Page 01-09



- Dissecting Knives
- Autopsy, Cartilage, Post Mortem & Brain Knives
- Razor Blade Holders & Breakers
- Scalpel Handle
- Scalpels, Tenotomes
- Amputating Knives, Autopsy Knives
- Scalpels, Tenotomes & Resection Knives
- Dermatomes



Razor Blade Holders & Breakers



TROUTMAN-CHRIS
01-1001
9 cm



TROUTMAN-CHRIS
01-1002
9 cm



01-1003
11 cm



CASTROVIEJO
01-1004
13 cm



01-1005
18.5 cm

Autopsy, Cartilage, Post Mortem & Brain Knives



1/2

01-1006
25.5 cm



VIRCHOW
01-1107



VIRCHOW
01-1008 - 01-1010

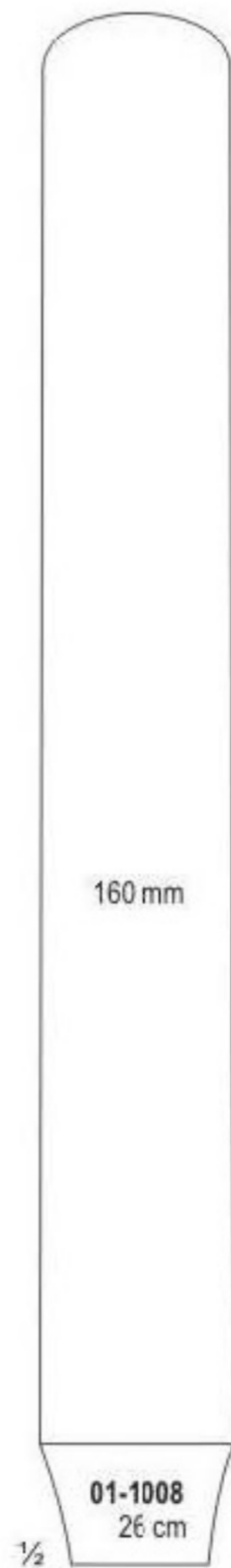

1/2

01-1008
26 cm



1/2

01-1009
33.5 cm

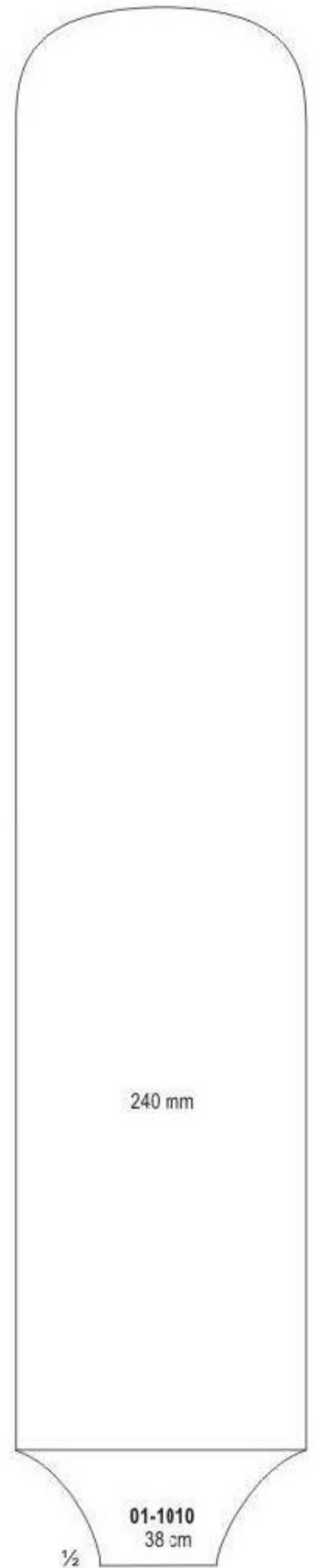

1/2

01-1010
38 cm

Dissecting Knives



Fig. 1
01-1011
15 cm



Fig. 2
01-1012
15 cm



Fig. 3
01-1013
16 cm



Fig. 4
01-1014
16 cm



Fig. 5
01-1015
16 cm



Fig. 6
01-1016
15 cm



Fig. 7
01-1017
15 cm



Fig. 8
01-1018
16 cm



Fig. 9
01-1019
16 cm



Fig. 10
01-1020
17 cm

DISSECTING KNIVES
Fig. 1 - 10
01-1011 - 01-1020

Scalpel Handle

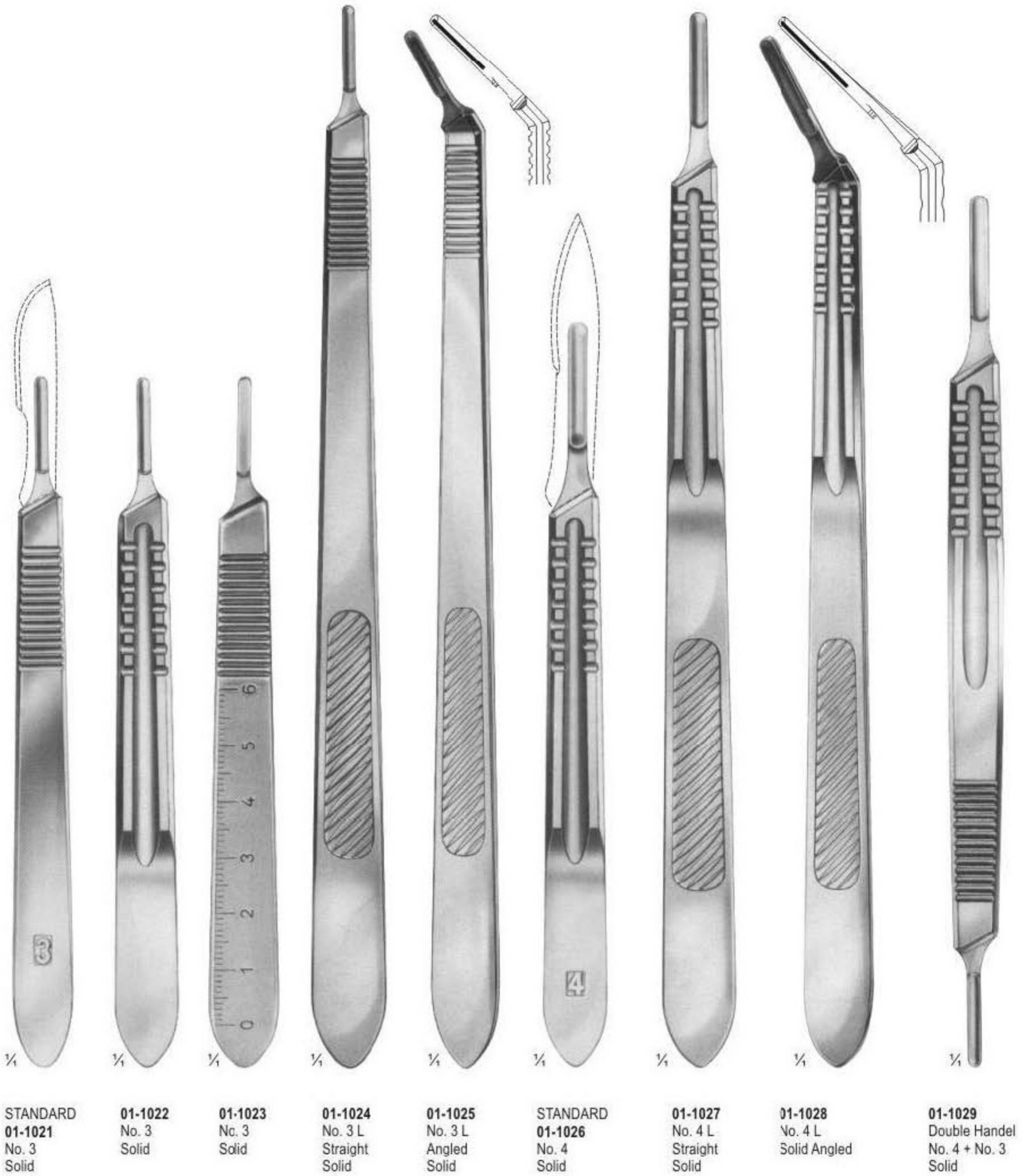

Scalpel Handle



01-1030
No. 7
Solid
16 cm

01-1031
No. 7 K
Solid
12.5 cm

01-1032
Hollow-Round
15.5 cm

01-1033
No. 3
Straight
Solid
14 cm

01-1034
No. 3
Angled
Solid

COLLIN
01-1035
No. 8
Hollow

COLLIN
01-1036
No. 9
Hollow

Scalpels, Tenotomes

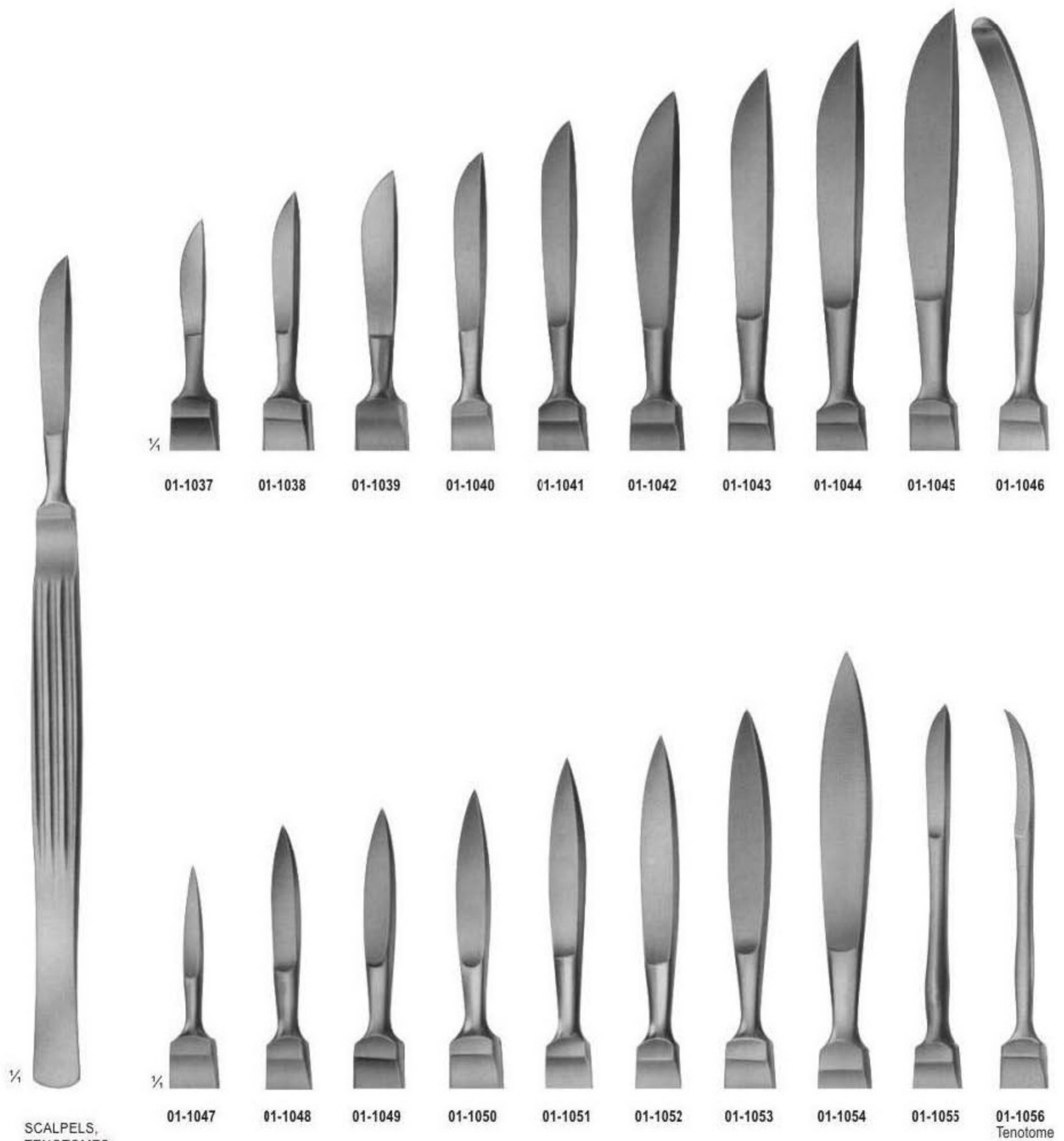

1/4

01-1037

01-1038

01-1039

01-1040

01-1041

01-1042

01-1043

01-1044

01-1045

01-1046

1/4

1/4

01-1047

01-1048

01-1049

01-1050

01-1051

01-1052

01-1053

01-1054

01-1055

01-1056
Tenotome

SCALPELS,
TENOTOMES
01-1037 - 01-1056
14 cm - 17.5 cm

Scalpels, Tenotomes & Resection Knives

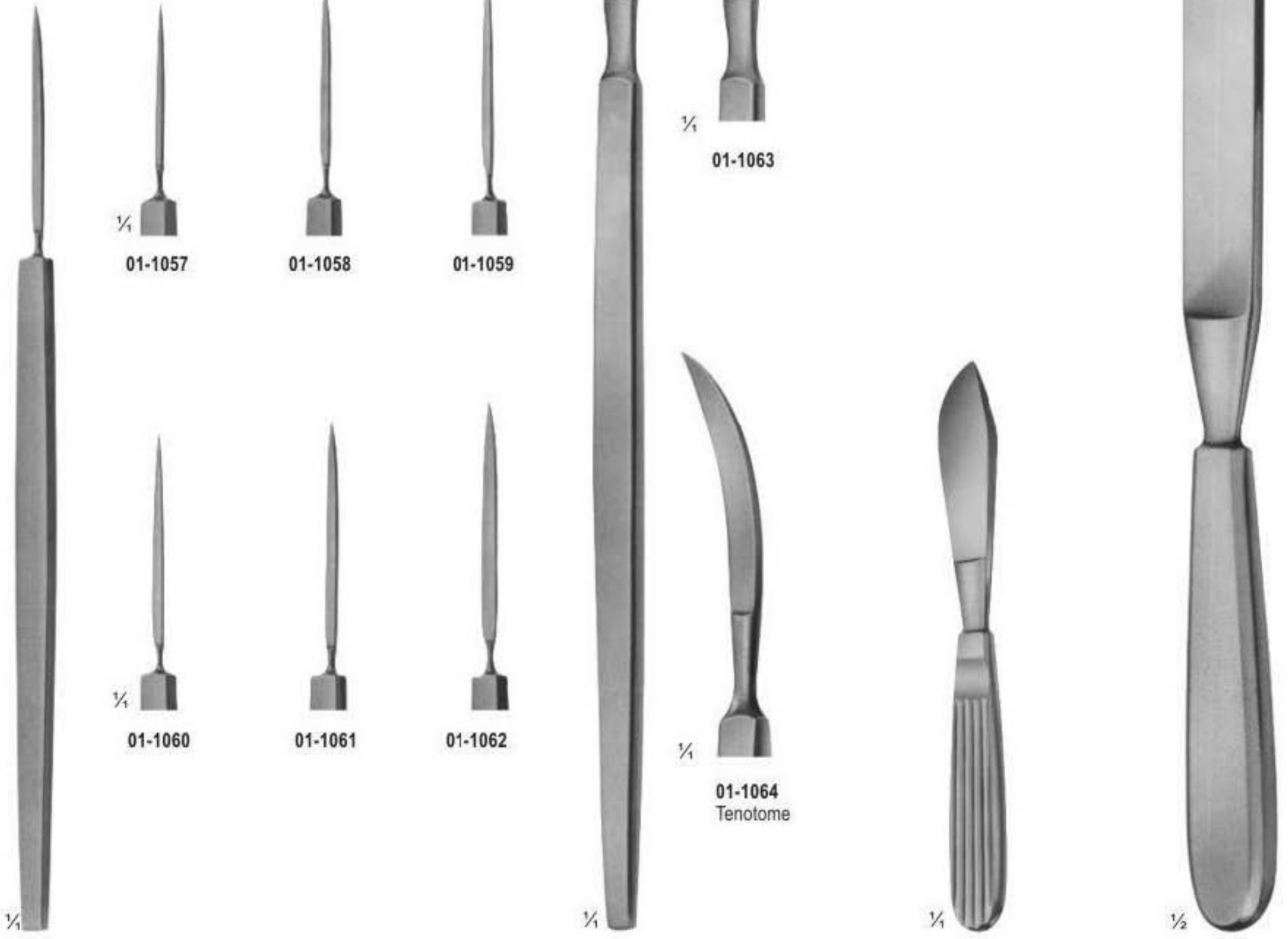

GRAEFE
01-1057 - 01-1052
13 cm

DIEFFENBACH
01-1063 - 01-1064
16 cm

01-1065
8 cm
Blade Length
Metal Handle

01-1066
19.5 cm
Blade Length
Metal Handle

Amputating Knives, Autopsy Knives



1/2

LISTON
01-1067 - 01-1068
01-1067 29 cm
01-1068 32 cm



1/2

CATLIN
01-1069 - 01-1070
01-1069 11 cm
01-1070 16 cm
Blade Length
Amputating
Knives



1/2

COLLIN
01-1071 - 01-1074
01-1071 13 cm
01-1072 16 cm
01-1073 19 cm
01-1074 20 cm
Blade Length
Amputating Knives



1/2

LANGENBECK
01-1075 - 01-1076
01-1075 12 cm
01-1076 18 cm
Blade Length
Flap Knives



1/2

LANGENBECK
01-1077
18 cm



1/2

LANGENBECK
01-1078
18 cm

Dermatomes



HUMBY
01-1079

HUMBY
01-1079
32 cm



SCHINK
01-1080

SCHINK
01-1080
30 cm



SILVER
01-1081
19.5 cm

Page 10-57

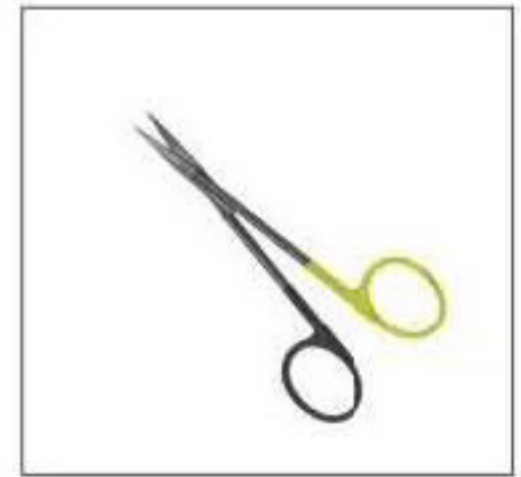

- Surgical Scissors
- Delicate Scissors
- Dissecting Scissors
- Operating & Gynaecology Scissors
- Vessel Scissors
- Delicate, Nasal & Tonsil Scissors
- Ligature Scissors
- Wire & Plate Scissors
- Bowel Scissors, Cartilage Scissors

Dissecting Scissors

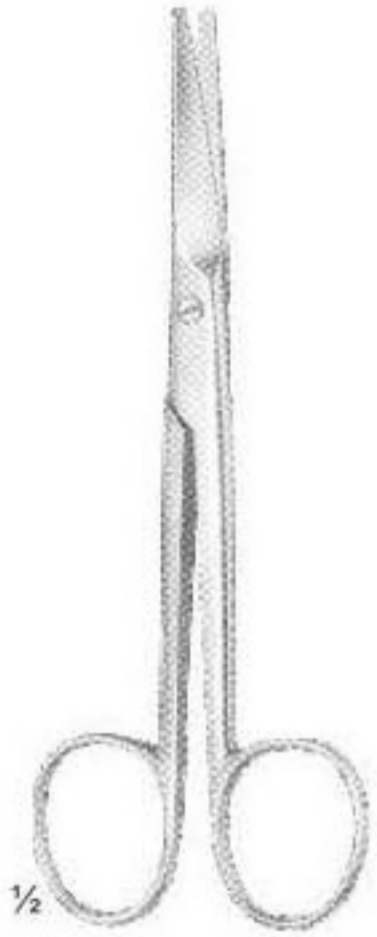

Straight

- MAYO
02-1001 - 02-1005
02-1001 15 cm
02-1002 16 cm
02-1003 17 cm
02-1004 19.5 cm
02-1005 21.5 cm

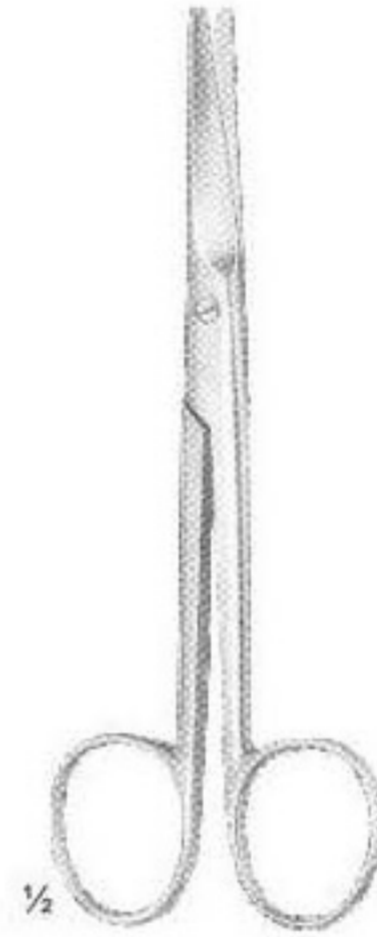

Curved

- MAYO
02-1006 - 02-1010
02-1006 15 cm
02-1007 16 cm
02-1008 17 cm
02-1009 19.5 cm
02-1010 21.5 cm

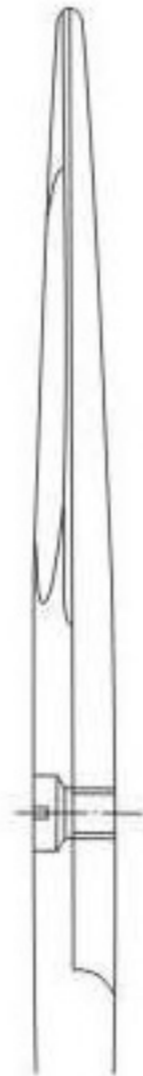

Straight

- MAYO
 With chamfered blades
02-1011 - 02-1015
02-1011 15 cm
02-1012 16 cm
02-1013 17 cm
02-1014 19.5 cm
02-1015 21.5 cm



Curved

- MAYO
 With chamfered blades
02-1016 - 02-1020
02-1016 15 cm
02-1017 16 cm
02-1018 17 cm
02-1019 19.5 cm
02-1020 21.5 cm

Dissecting Scissors



Straight

MAYO-STILLE
02-1021 - 02-1025
02-1021 15 cm
02-1022 16 cm
02-1023 17 cm
02-1024 19.5 cm
02-1025 21.5 cm



Curved

MAYO-STILLE
02-1026 - 02-1030
02-1026 15 cm
02-1027 16 cm
02-1028 17 cm
02-1029 19.5 cm
02-1030 21.5 cm



Straight

MAYO-STILLE
With chamfered blades
02-1031 - 02-1035
02-1031 15 cm
02-1032 16 cm
02-1033 17 cm
02-1034 19.5 cm
02-1035 21.5 cm



Curved

MAYO-STILLE
With chamfered blades
02-1036 - 02-1040
02-1036 15 cm
02-1037 16 cm
02-1038 17 cm
02-1039 19.5 cm
02-1040 21.5 cm

Dissecting Scissors

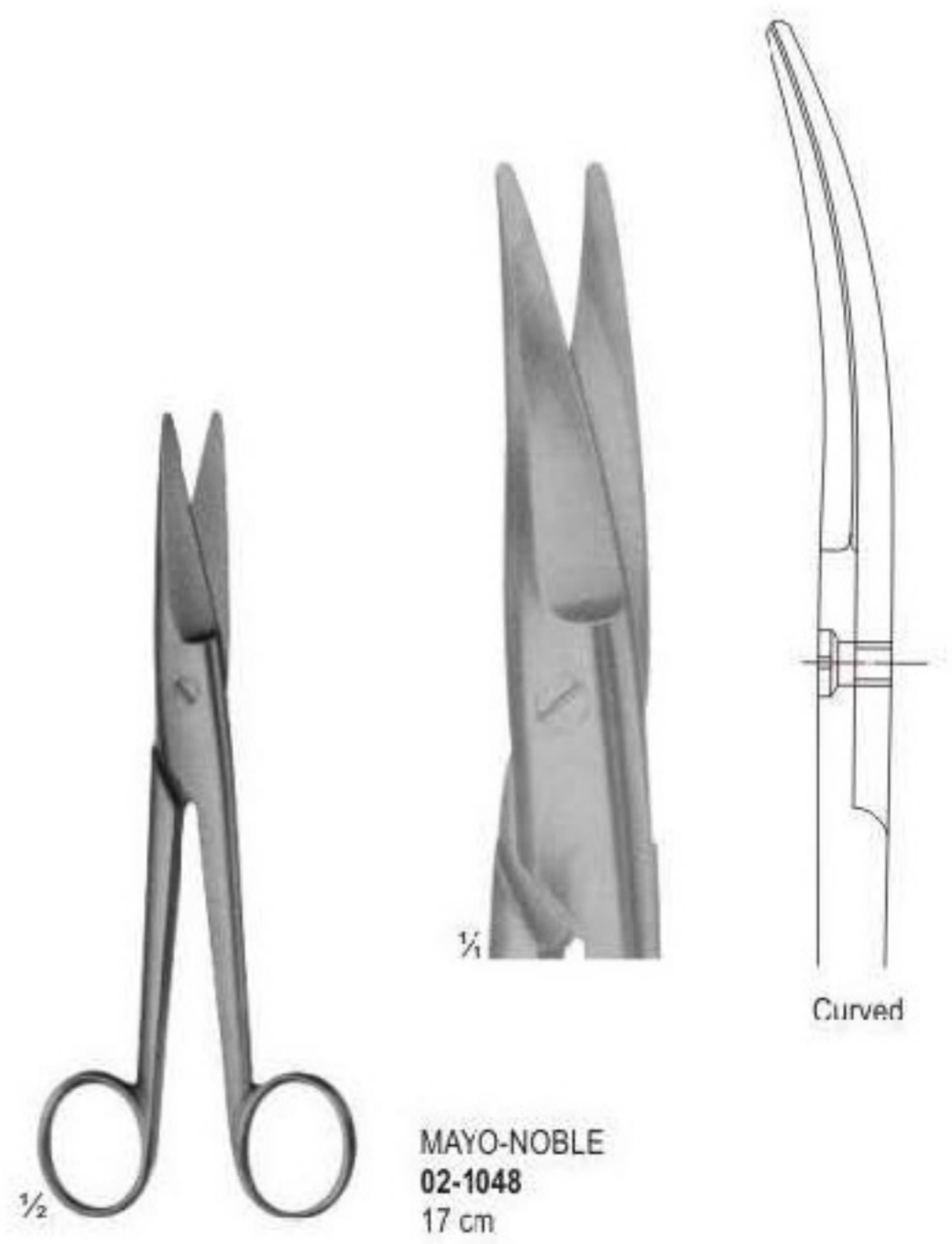
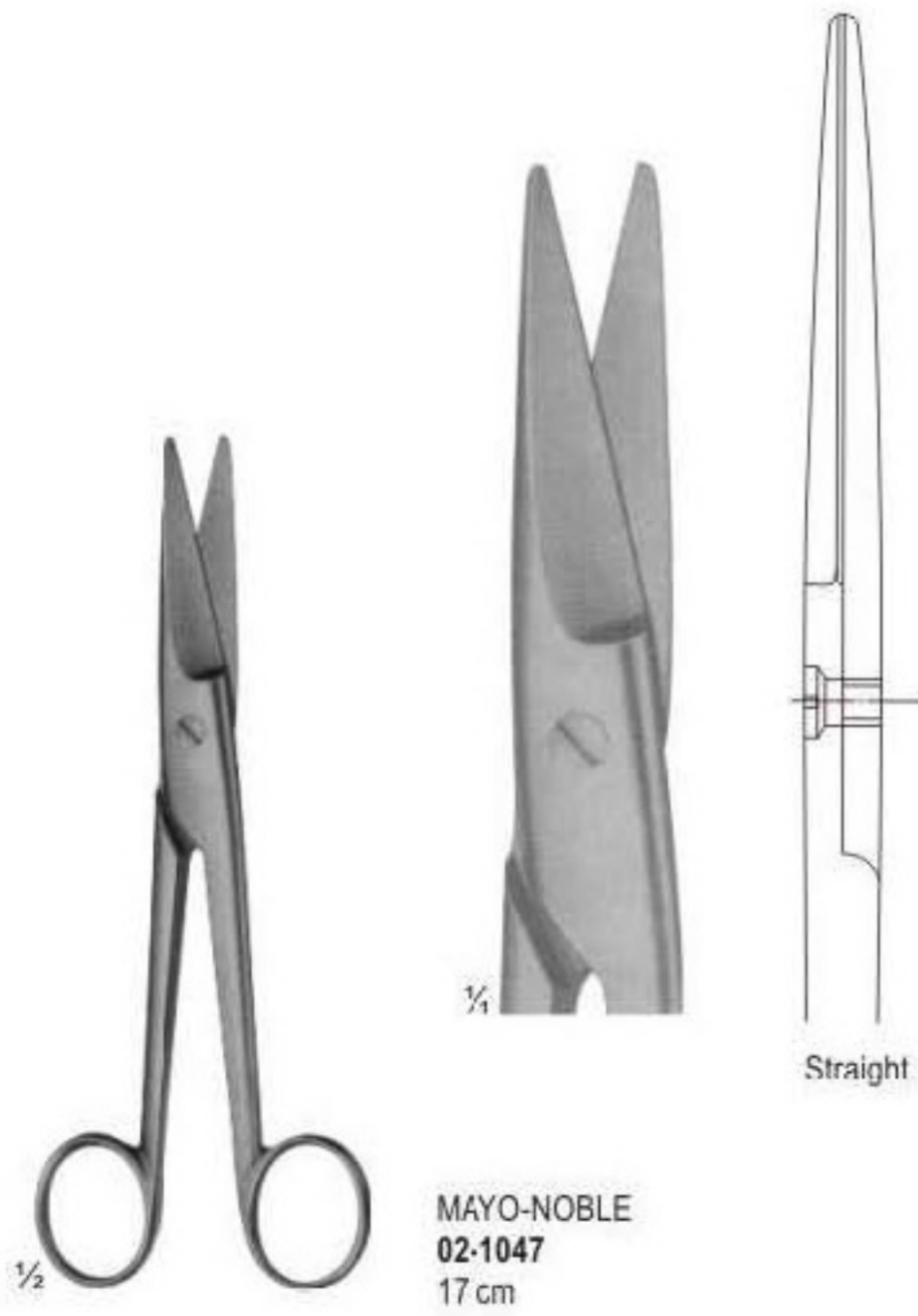
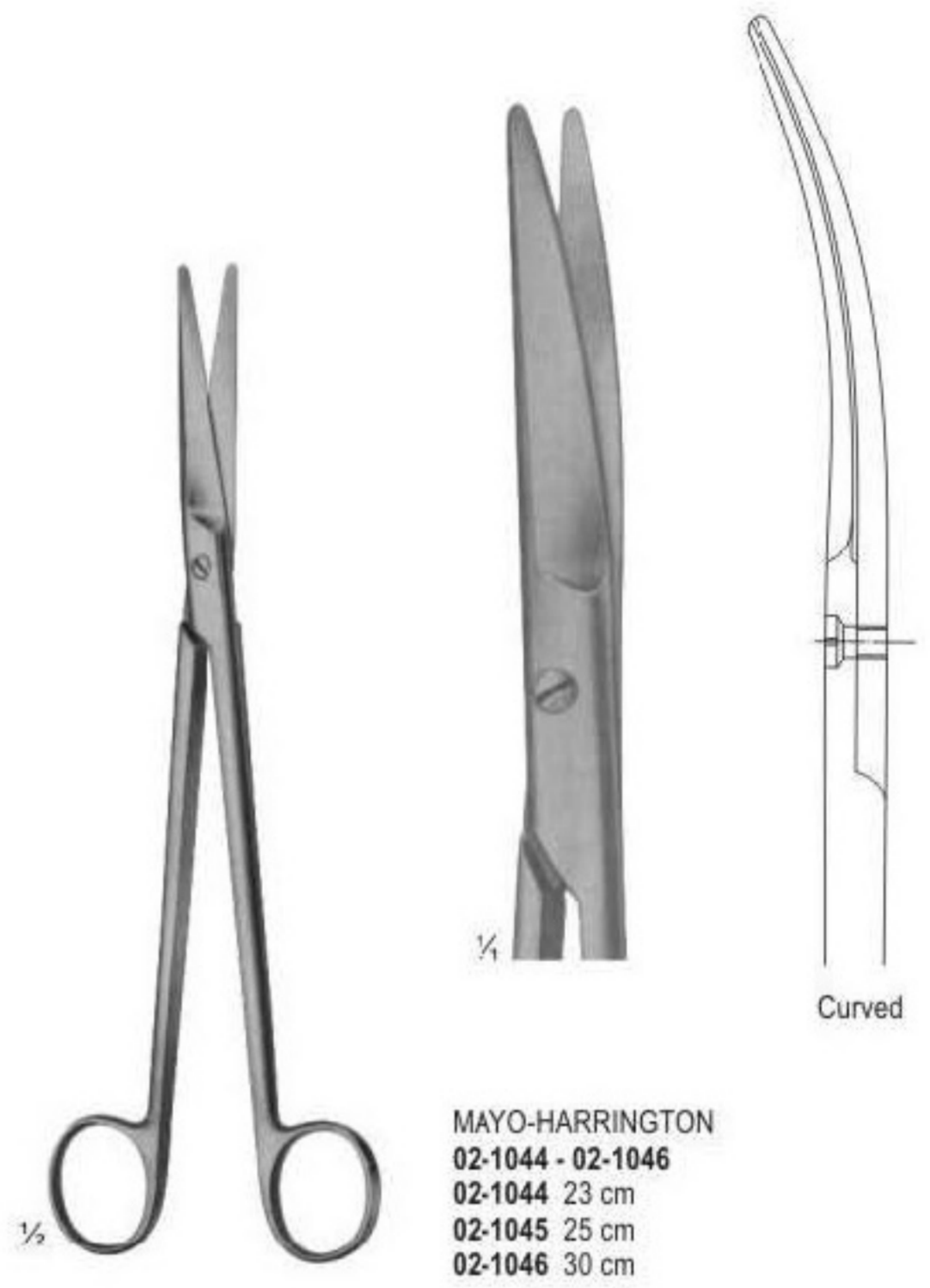
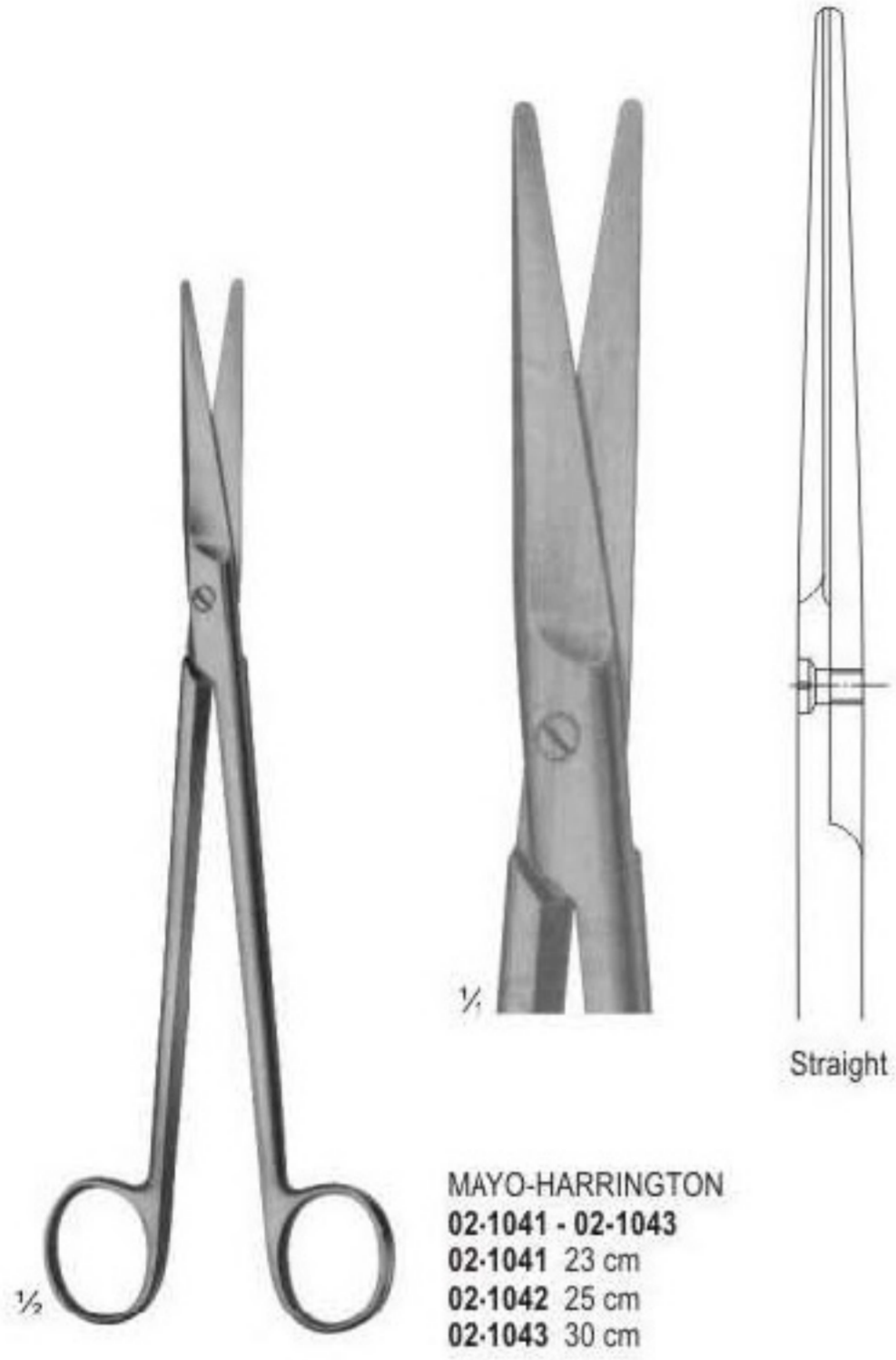

Surgical Scissors



Straight

- STANDARD
BL/BL
- 02-1049 - 02-1055**
 - 02-1049** 10.5 cm
 - 02-1050** 11.5 cm
 - 02-1051** 13 cm
 - 02-1052** 14.5 cm
 - 02-1053** 16.5 cm
 - 02-1054** 18.5 cm
 - 02-1055** 20 cm

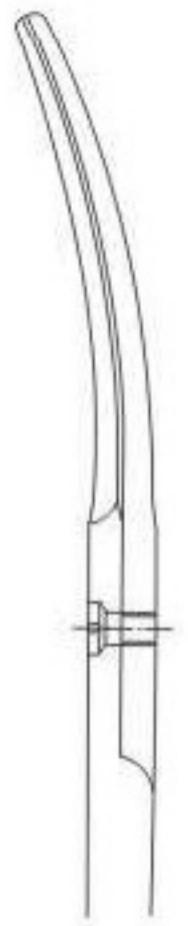

Curved

- STANDARD
BL/BL
- 02-1056 - 02-1062**
 - 02-1056** 10.5 cm
 - 02-1057** 11.5 cm
 - 02-1058** 13 cm
 - 02-1059** 14.5 cm
 - 02-1060** 16.5 cm
 - 02-1061** 18.5 cm
 - 02-1062** 20 cm

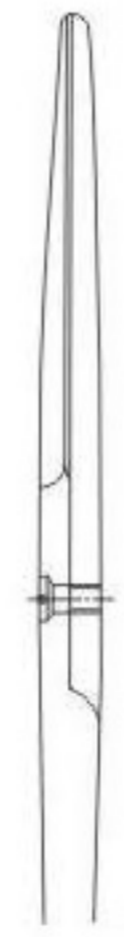

Straight

- STANDARD
BL/SH
- 02-1063 - 02-1069**
 - 02-1063** 10.5 cm
 - 02-1064** 11.5 cm
 - 02-1065** 13 cm
 - 02-1066** 14.5 cm
 - 02-1067** 16.5 cm
 - 02-1068** 18.5 cm
 - 02-1069** 20 cm



Curved

- STANDARD
BL/SH
- 02-1070 - 02-1076**
 - 02-1070** 10.5 cm
 - 02-1071** 11.5 cm
 - 02-1072** 13 cm
 - 02-1073** 14.5 cm
 - 02-1074** 16.5 cm
 - 02-1075** 18.5 cm
 - 02-1076** 20 cm

Surgical Scissors



Straight

STANDARD SH/SH
02-1077 - 02-1083
02-1077 10.5 cm
02-1078 11.5 cm
02-1079 13 cm
02-1080 14.5 cm
02-1081 16.5 cm
02-1082 18.5 cm
02-1083 20 cm



Curved

STANDARD SH/SH
02-1084 - 02-1090
02-1084 10.5 cm
02-1085 11.5 cm
02-1086 13 cm
02-1087 14.5 cm
02-1088 16.5 cm
02-1089 18.5 cm
02-1090 20 cm



02-1092
SH/BI
straight
14.5 cm

DEAVER
02-1092 - 02-1094

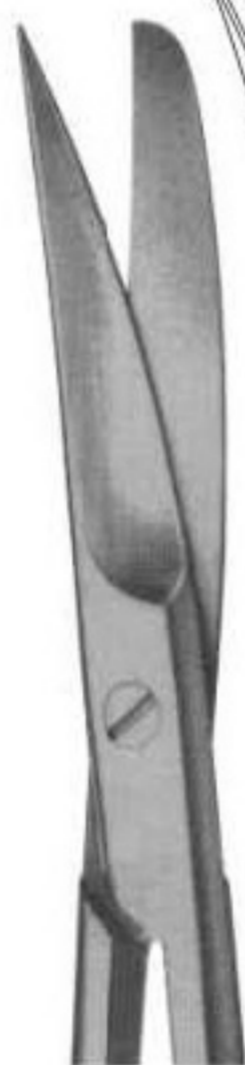

02-1293
SH/BI
curved
14.5 cm



02-1094
BI/BI
curved
14.5 cm

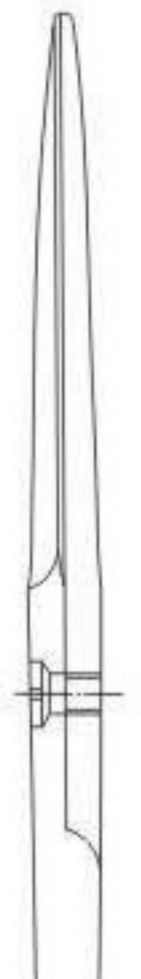

Straight

INCISION SCISSORS
02-1095 - 02-1097
02-1095 13 cm
02-1096 14.5 cm
02-1097 16.5 cm

Dissecting Scissors



Straight

- METZENBAUM**
02-1098 - 02-1106
02-1098 11.5 cm (Baby)
02-1099 14.5 cm
02-1100 15.5 cm
02-1101 18 cm
02-1102 20 cm
02-1103 23 cm
02-1104 25 cm
02-1105 28 cm
02-1106 30 cm



Curved

- METZENBAUM**
02-1107 - 02-1116
02-1108 11.5 cm (Baby)
02-1109 14.5 cm
02-1110 15.5 cm
02-1111 18 cm
02-1112 20 cm
02-1113 23 cm
02-1114 25 cm
02-1115 28 cm
02-1116 30 cm



Straight

- METZENBAUM-NELSON**
02-1116 - 02-1121
02-1116 18 cm
02-1117 20 cm
02-1118 23 cm
02-1119 26 cm
02-1120 28 cm
02-1121 30 cm

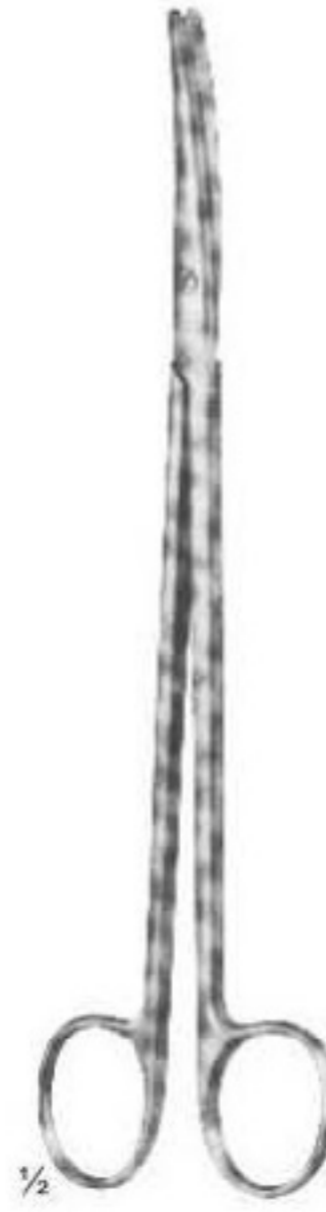

Curved

- METZENBAUM-NELSON**
02-1122 - 02-1127
02-1122 18 cm
02-1123 20.5 cm
02-1124 23 cm
02-1125 26 cm
02-1126 28.5 cm
02-1127 31 cm

Dissecting Scissors



Straight

- FINO-METZENBAUM**
02-1128 - 02-1133
02-1128 18 cm
02-1129 20 cm
02-1130 23 cm
02-1131 26 cm
02-1132 28 cm
02-1133 30 cm



Curved

- FINO-METZENBAUM**
02-1134 - 02-1139
02-1134 18 cm
02-1135 20 cm
02-1136 23 cm
02-1137 26 cm
02-1138 28 cm
02-1139 30 cm

Dissecting Scissors

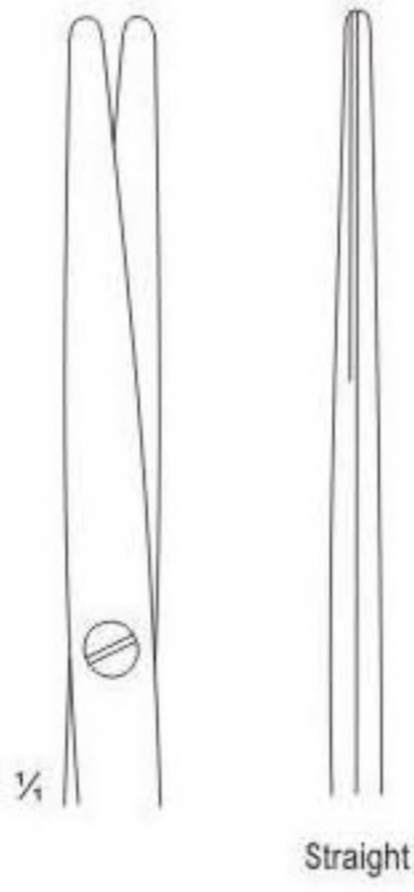

LEXER
02-1140 - 02-1142
02-1140 10 cm (Baby)
02-1141 16 cm
02-1142 21 cm

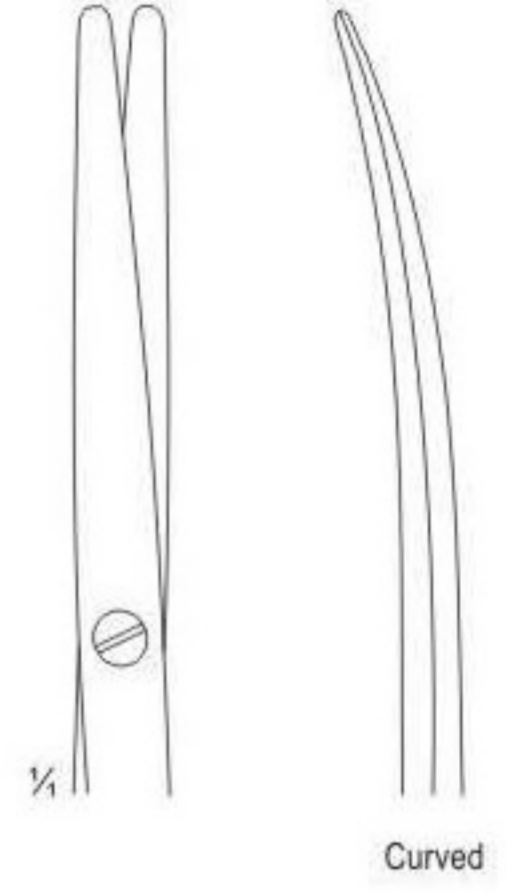

LEXER
02-1143 - 02-1145
02-1143 10 cm (Baby)
02-1144 16 cm
02-1145 21 cm



LEXER
02-1146 - 02-1148
02-1146 10 cm (Baby)
02-1147 16 cm
02-1148 21 cm



LEXER
02-1149 - 02-1151
02-1149 10 cm (Baby)
02-1150 16 cm
02-1151 21 cm

Dissecting Scissors



LEXER-FINO
02-1152
16.5 cm



Straight



LEXER-FINO
02-1153
16.5 cm



Curved

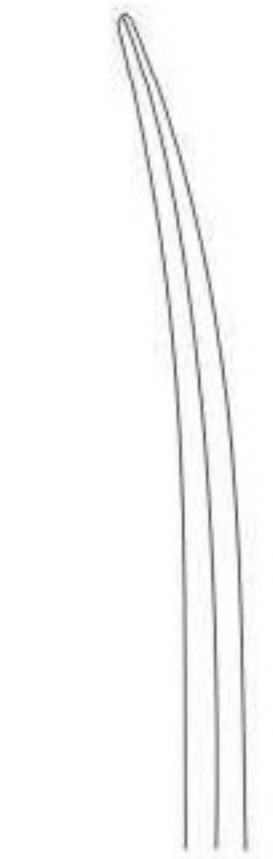

LANDOLT
Enucleation scissors
02-1154
12 cm



Curved



LANDOLT
Enucleation scissors
02-1155
12 cm



Curved



Delicate Scissors



KELLY
02-1156
17.5 cm

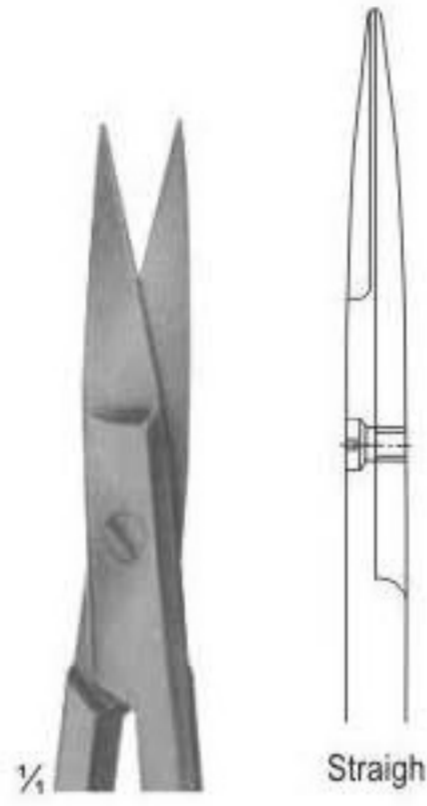

KELLY
02-1157
17.5 cm

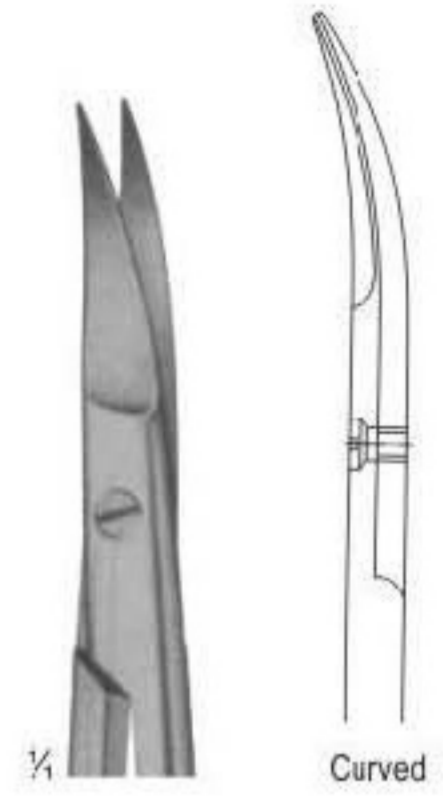

DOYEN
02-1158
18.5 cm

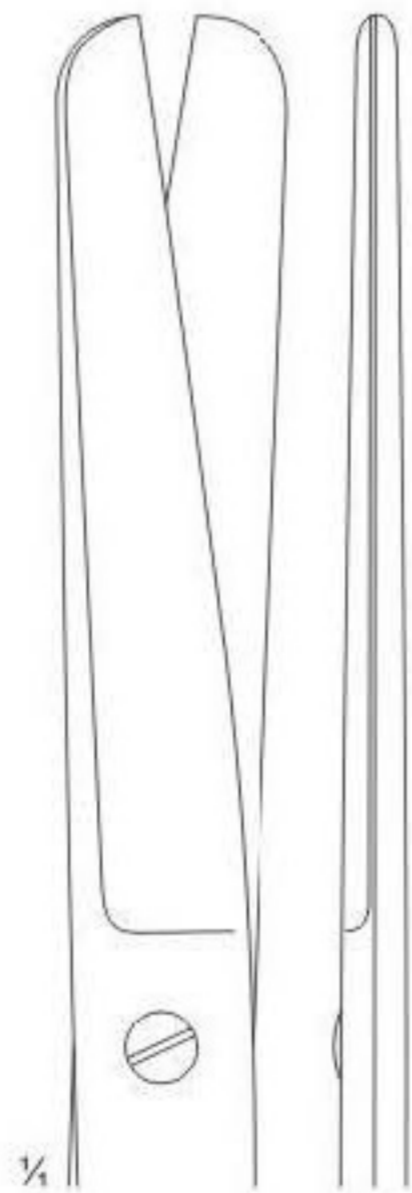

DOYEN
02-1159
18.5 cm

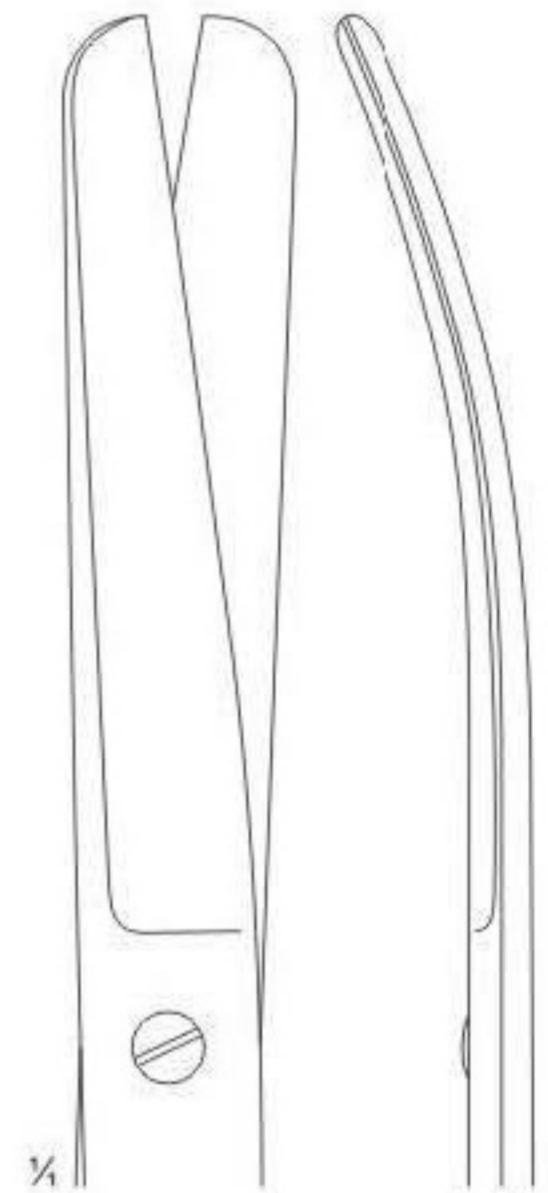

Operating And Gynaecology Scissors

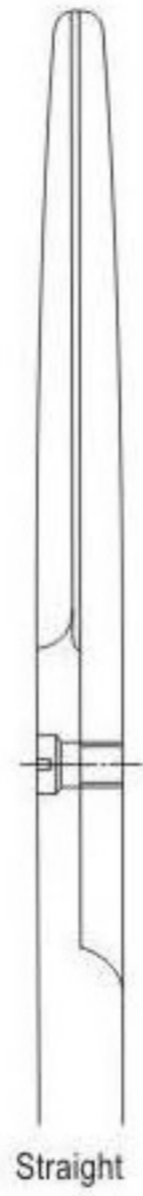

SIMS
02-1160 - 02-1161
02-1160 20 cm
02-1161 23 cm



SIMS
02-1162 - 02-1164
02-1162 20 cm
02-1163 21 cm
02-1164 23 cm



SIMS
02-1165 - 02-1166
02-1165 20 cm
02-1166 23 cm



SIMS
02-1167 - 02-1169
02-1167 20 cm
02-1168 21 cm
02-1169 23 cm

Operating And Gynaecology Scissors

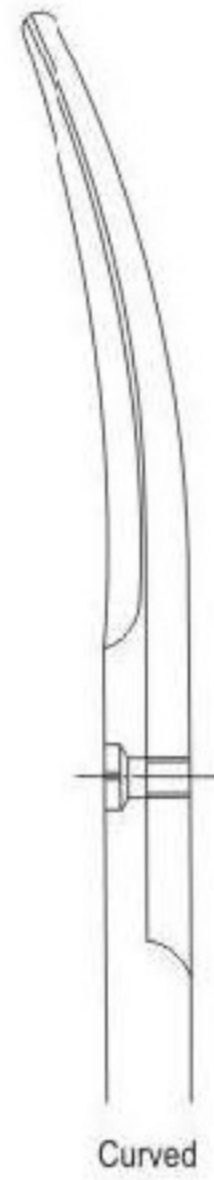
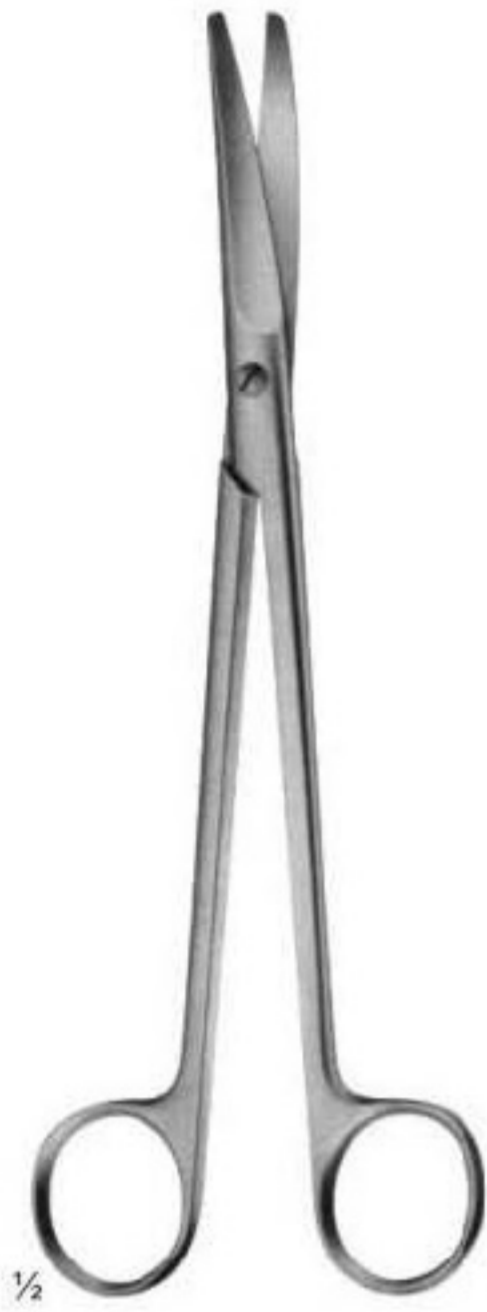

Curved

1/2

SIMS
02-1170 - 02-1172
02-1170 20 cm
02-1171 21 cm
02-1172 23 cm

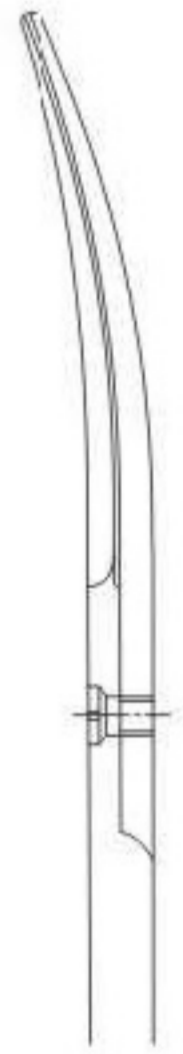

Curved

1/2

WERTHEIM
02-1173 - 02-1175
02-1173 14.5 cm
02-1174 20 cm
02-1175 23 cm

Operating And Gynaecology Scissors



SIEBOLD
02-1176
Uterine Scissors
24.5 cm

BOZEMANN
02-1177
Uterine Scissors
22 cm

SIMS-SIEBOLD
02-1178
Uterine Scissors
25 cm

Delicate Scissors

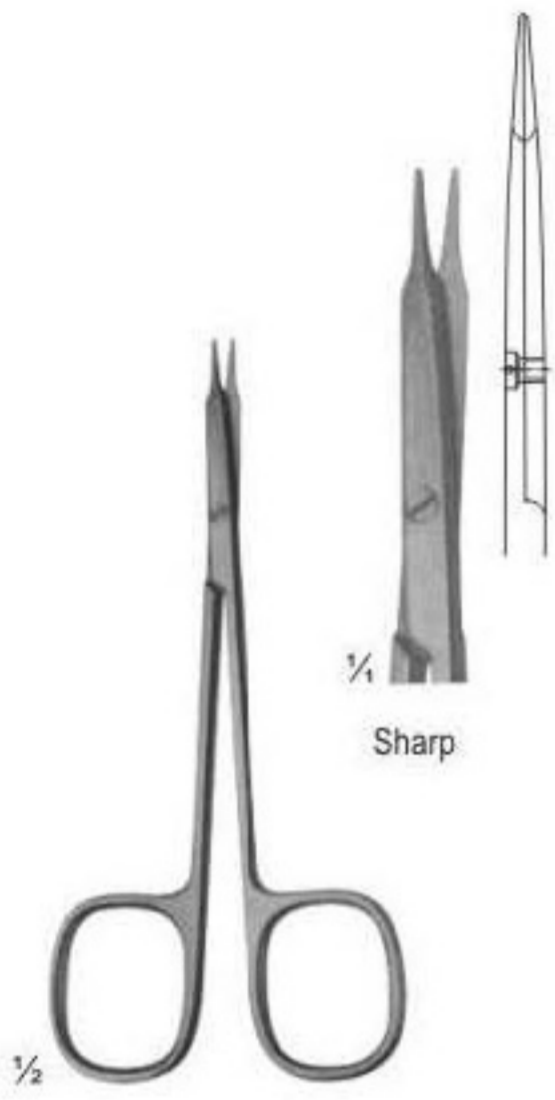

STEVENS
Dissecting Scissors
02-1179
11.5 cm

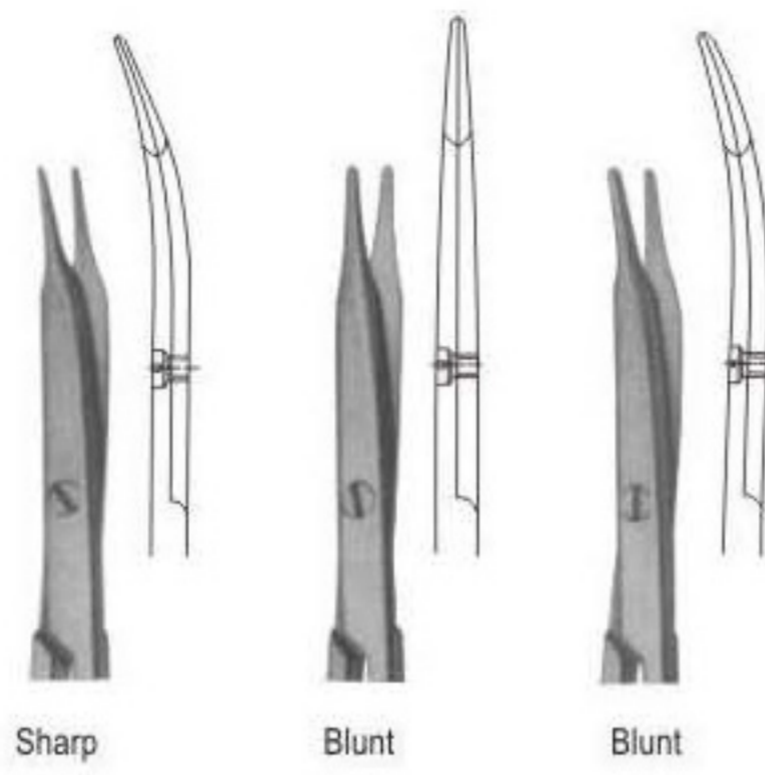

STEVENS
Vessel and tendon Scissors
02-1180 - 02-1181

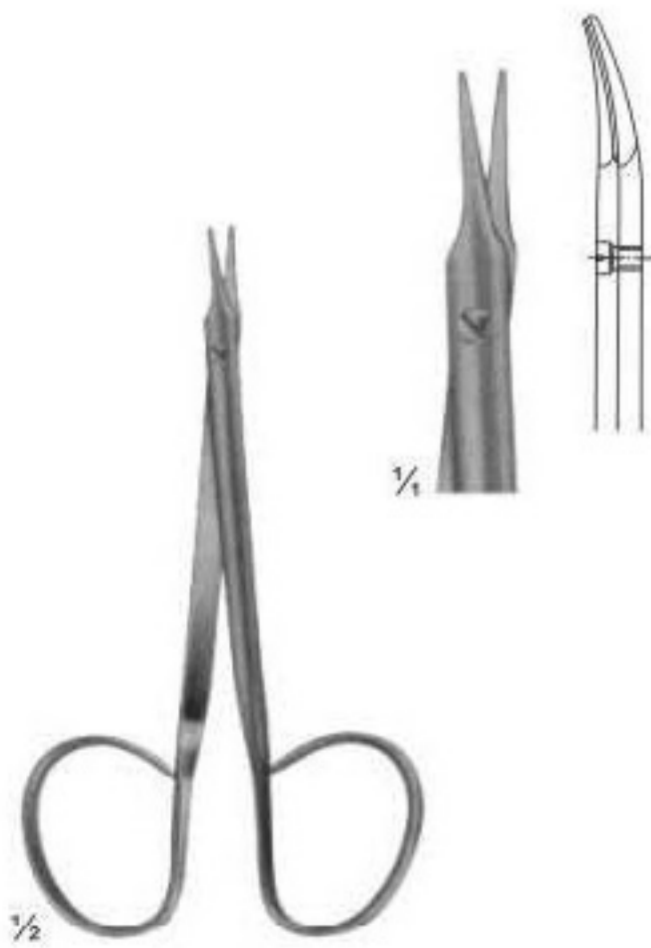

STEVENS
Fine Dissecting Scissors
02-1182
11 cm

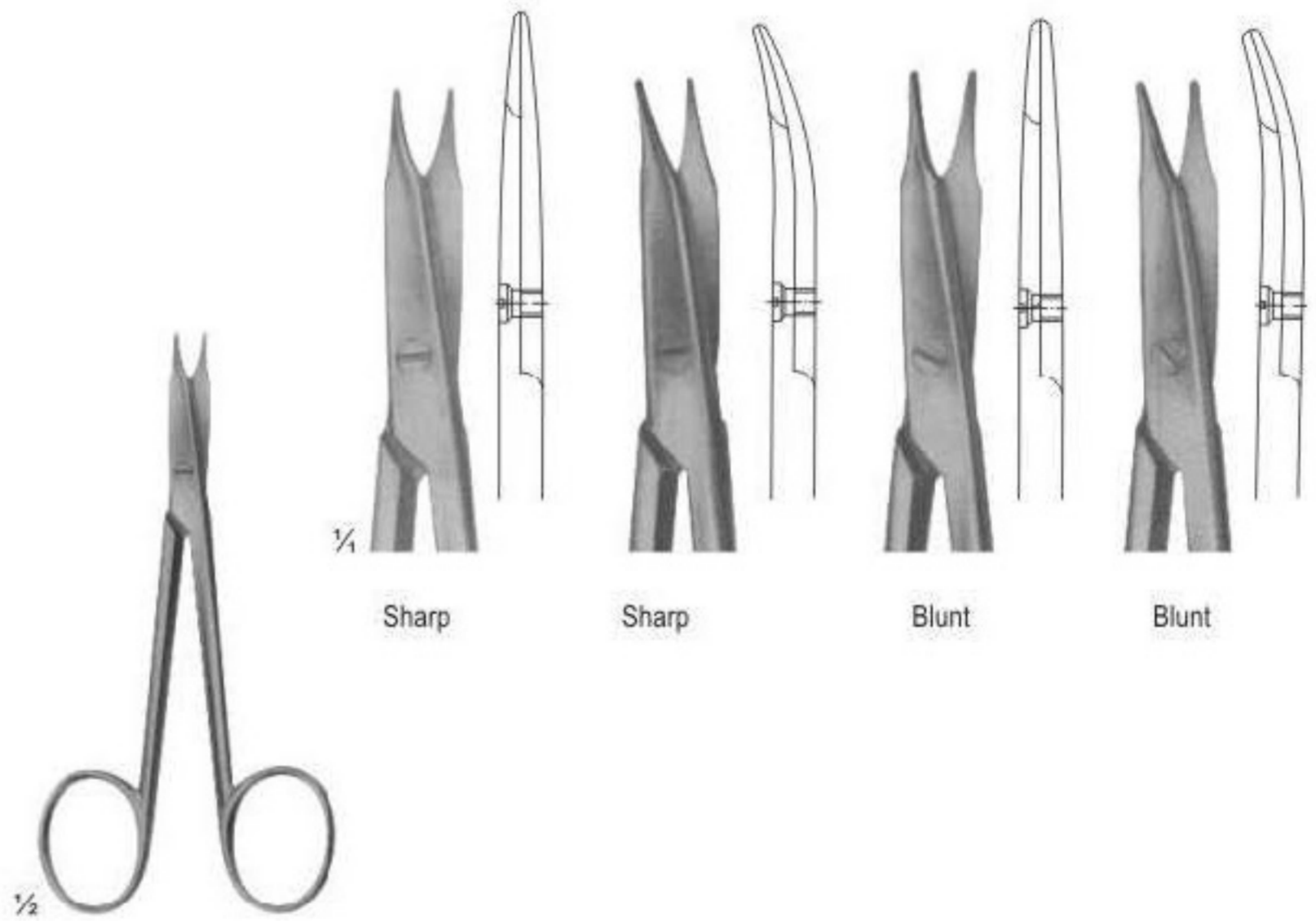

STEVENS
Vessel and tendon Scissors
02-1183
11 cm

Dissecting Scissors

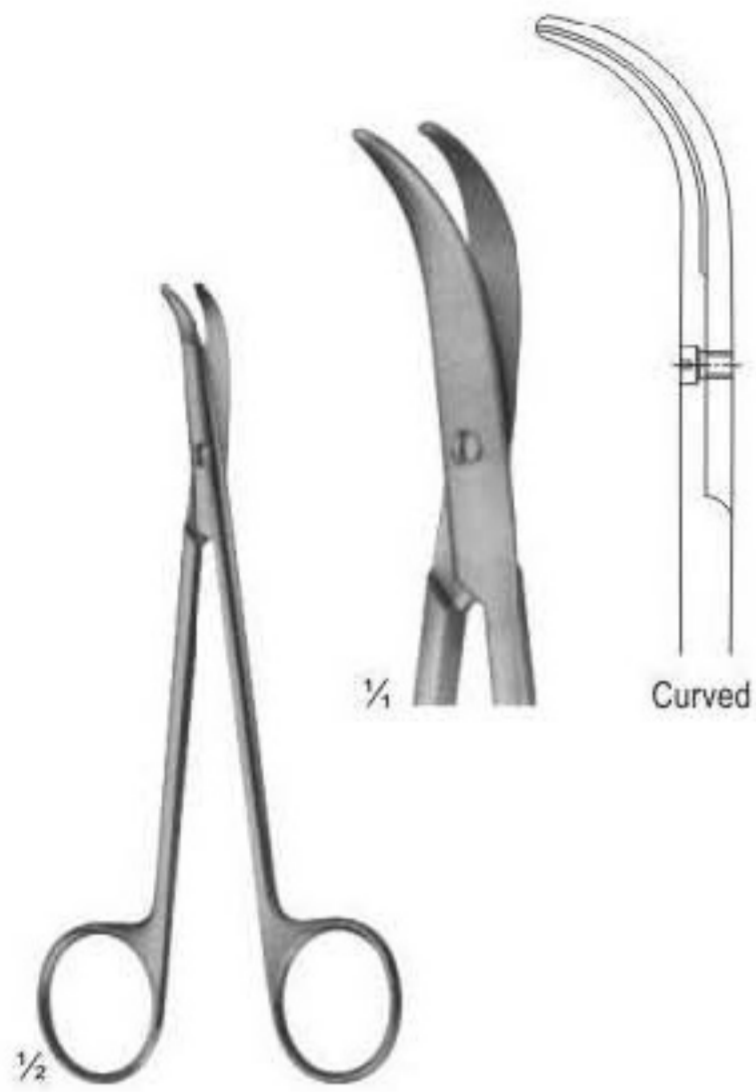

FOMON
02-1184 - 02-1185
02-1184 11.5 cm
02-1185 13.5 cm
Lower lateral scissors

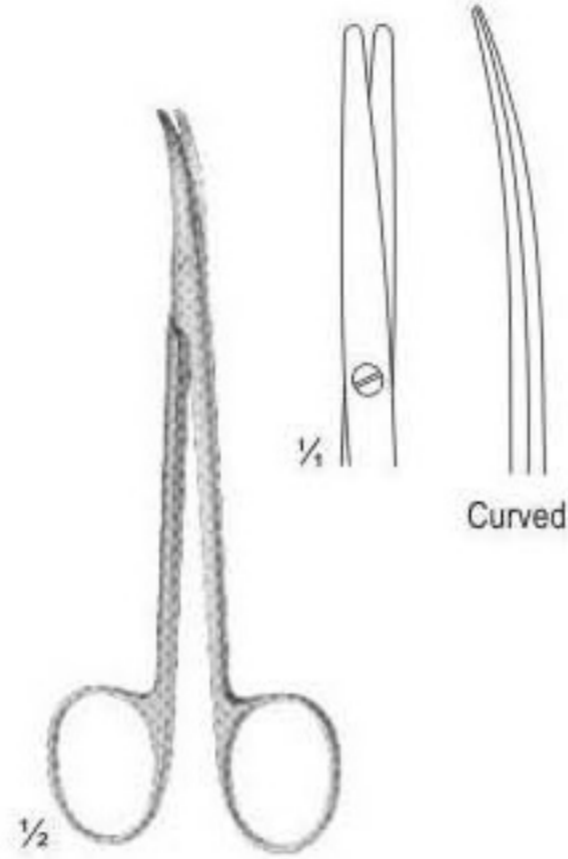

CINELLI
02-1186
11.5 cm

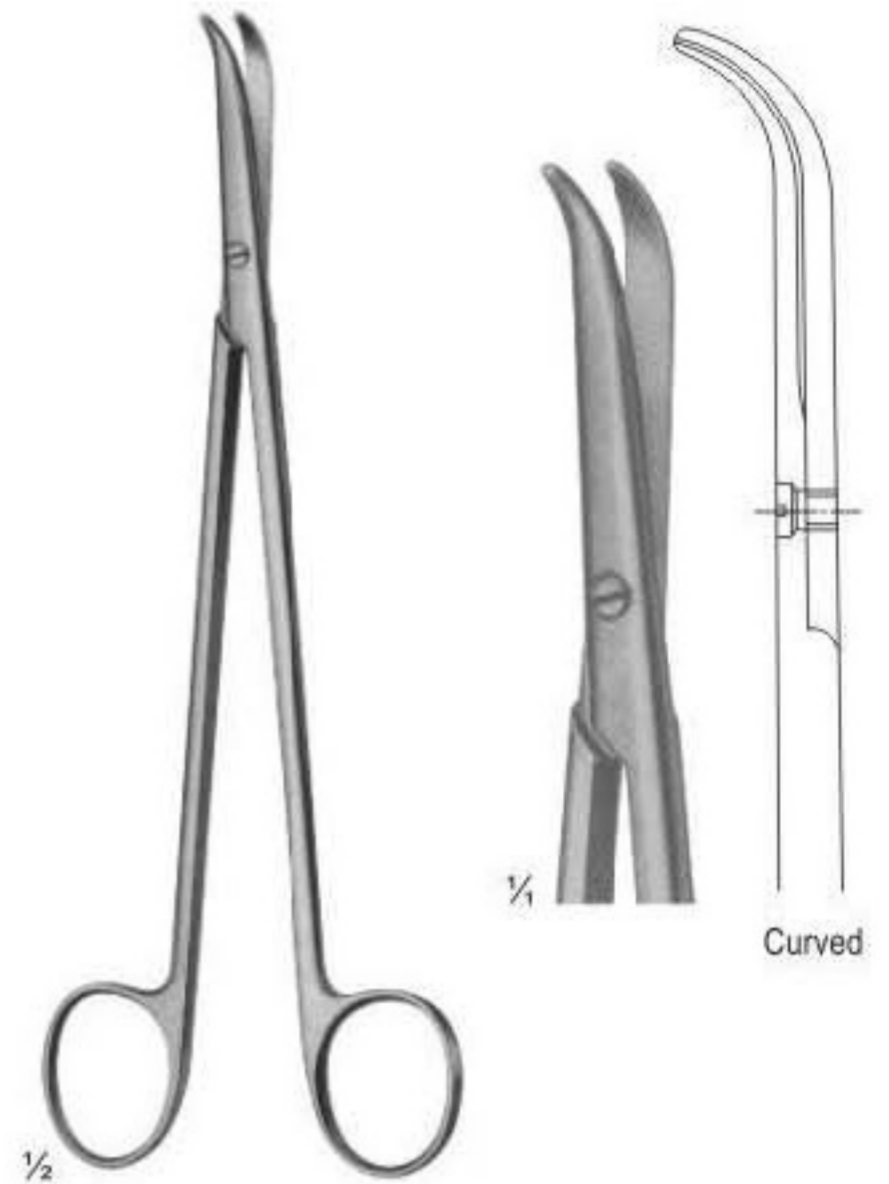

THOREK
02-1187
18 cm

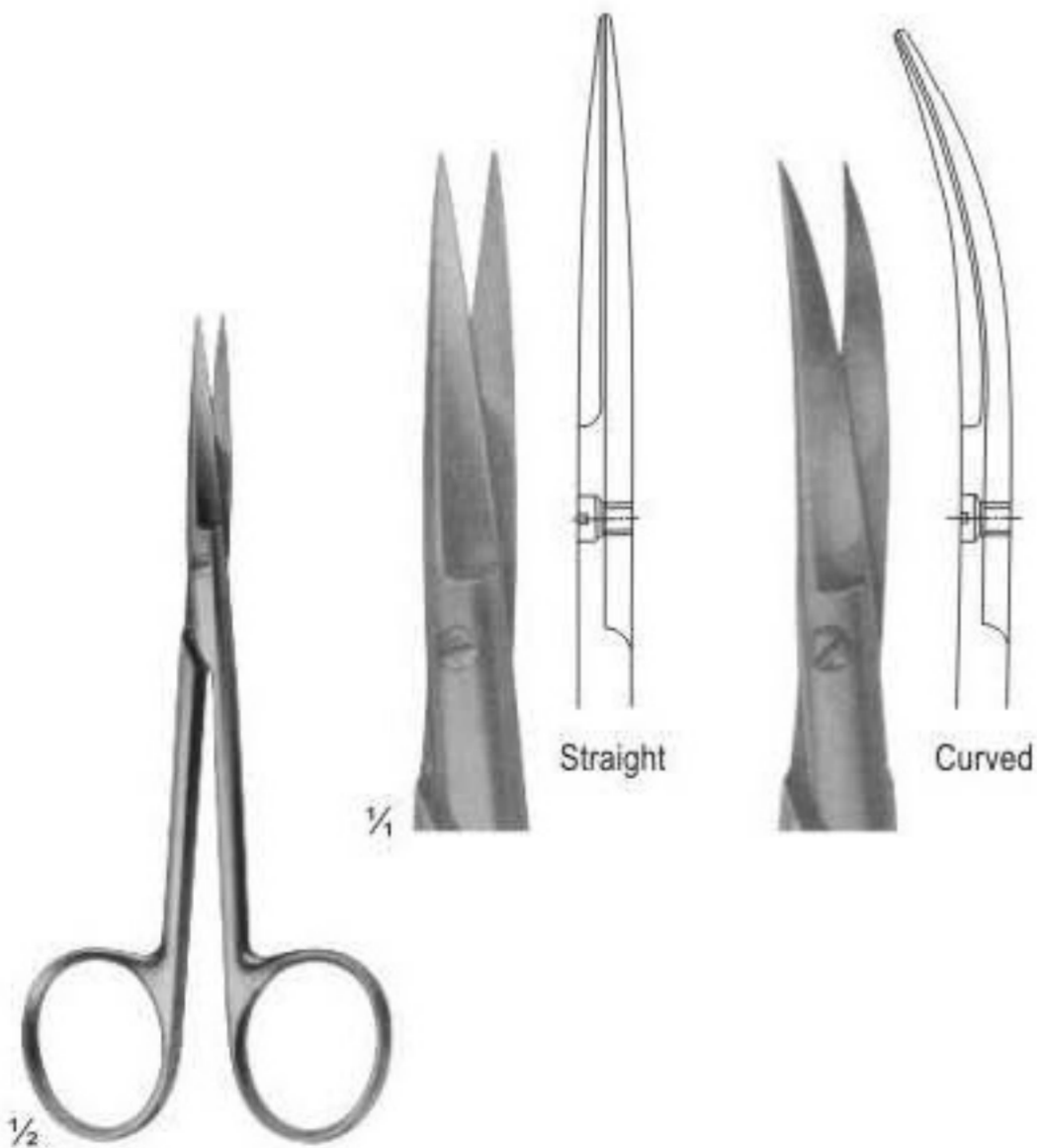

WAGNER
02-1188
13 cm

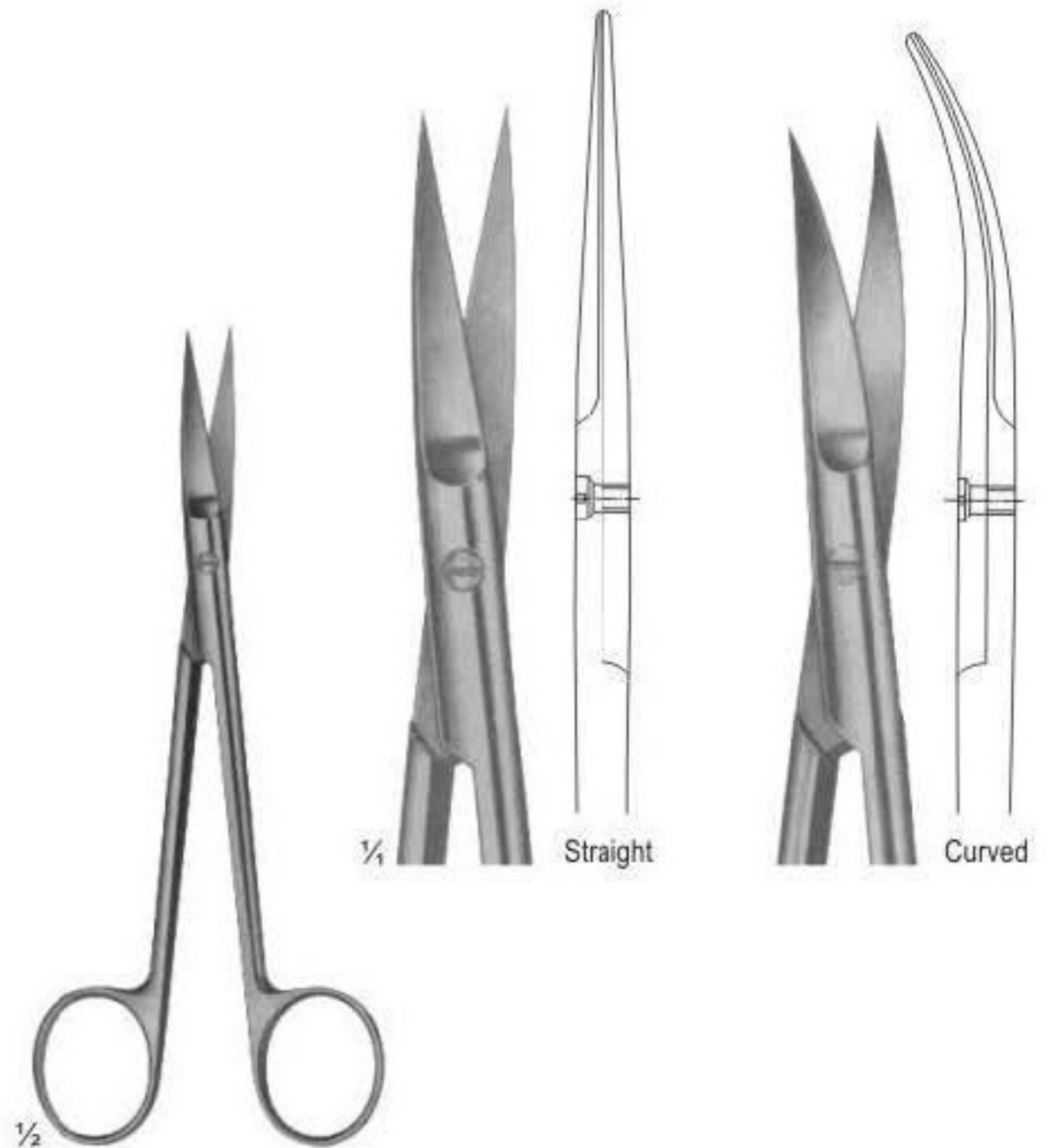

JOSEPH
02-1189
15 cm

Delicate Scissors

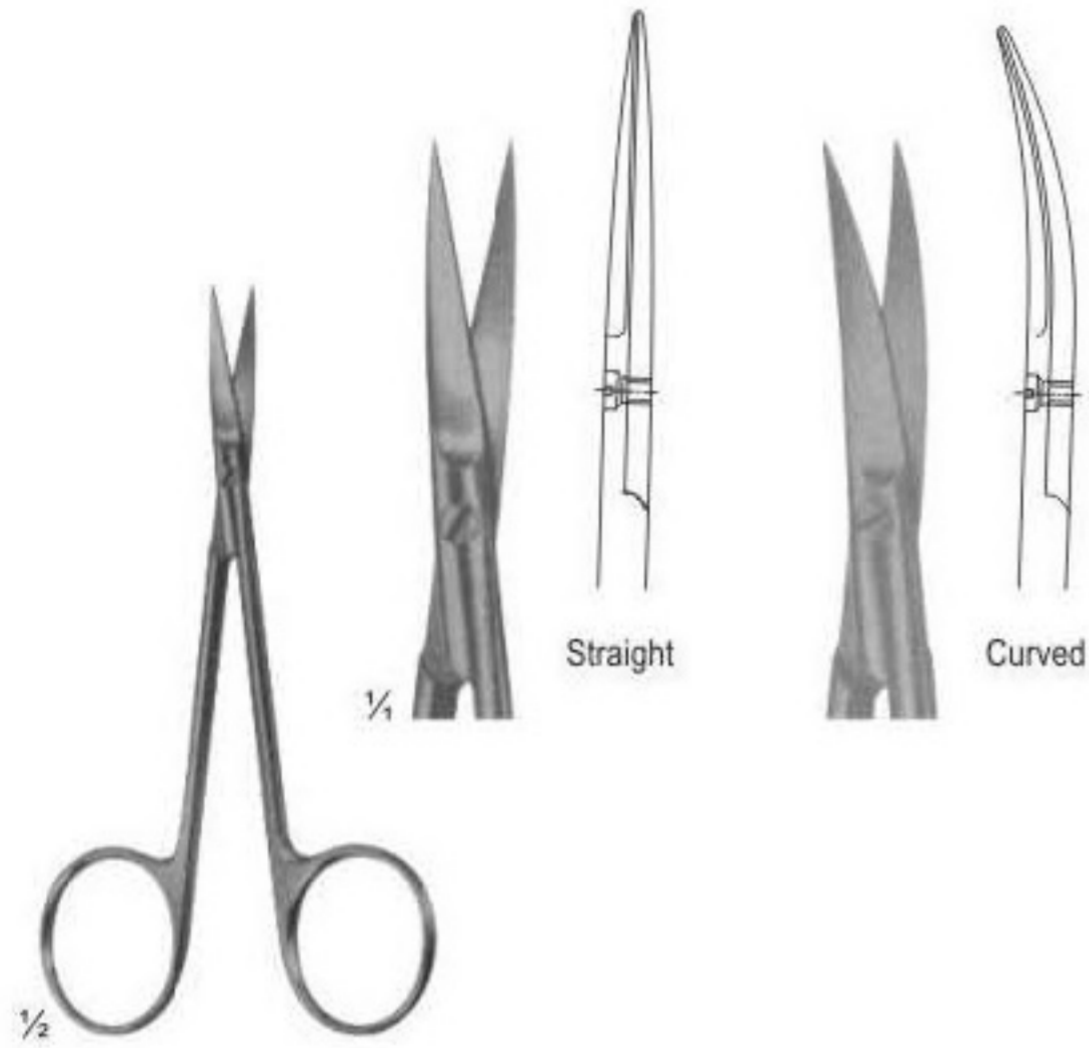

IRIS
02-1190 - 02-1192
02-1190 9 cm
02-1191 10 cm
02-1192 11.5 cm

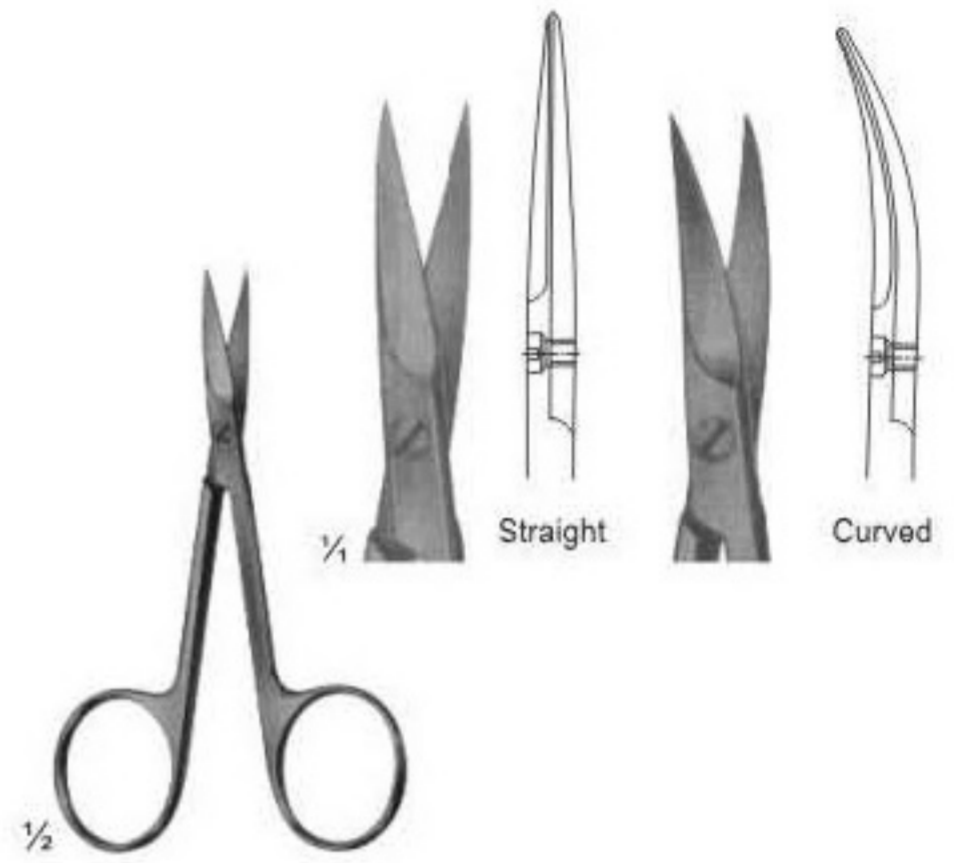

CUTICAL
02-1193
9 cm

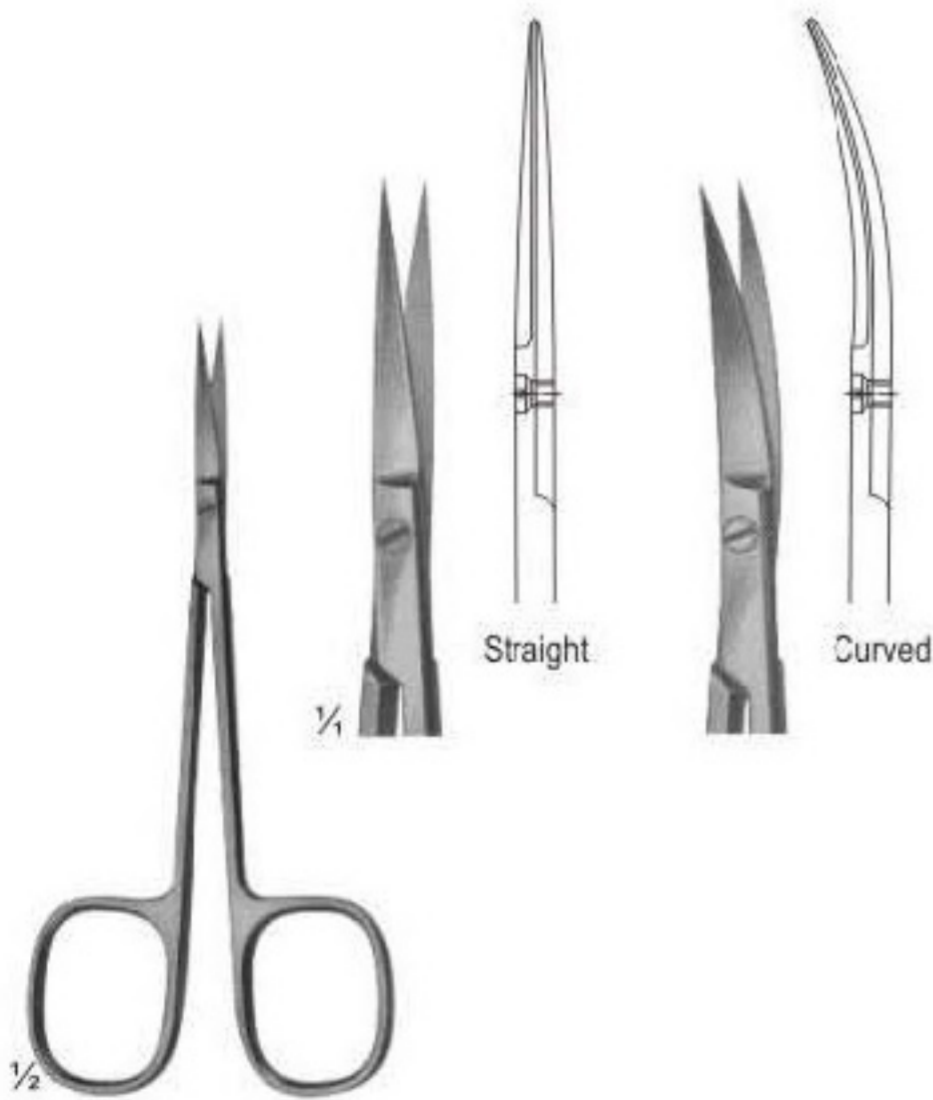

02-1194
12 cm

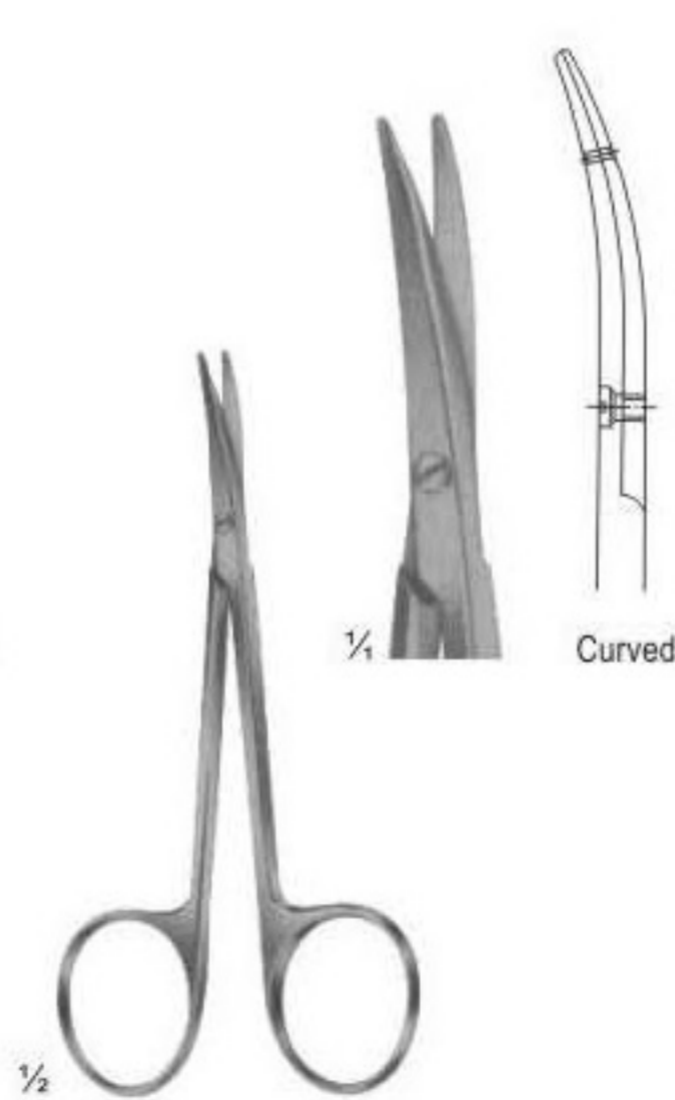

LITTLER
Dissecting Scissors
Tips with eye for suture
02-1195
11.5 cm

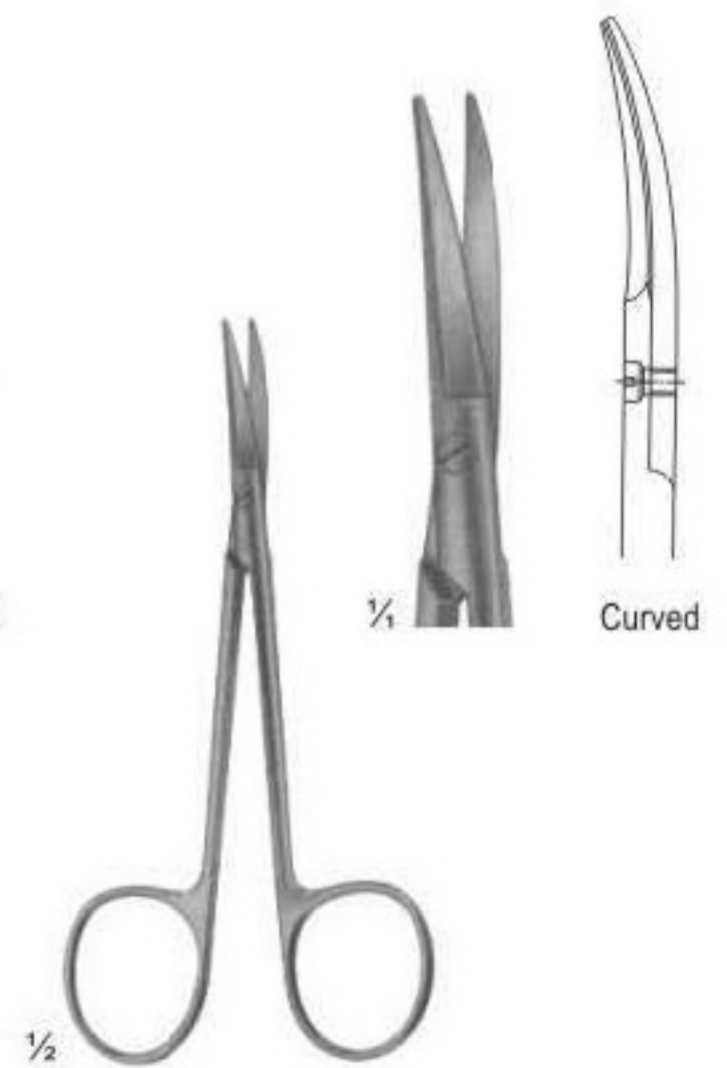

COTTLE
Bulldog Scissors
02-1196
11.5 cm

Dissecting Scissors

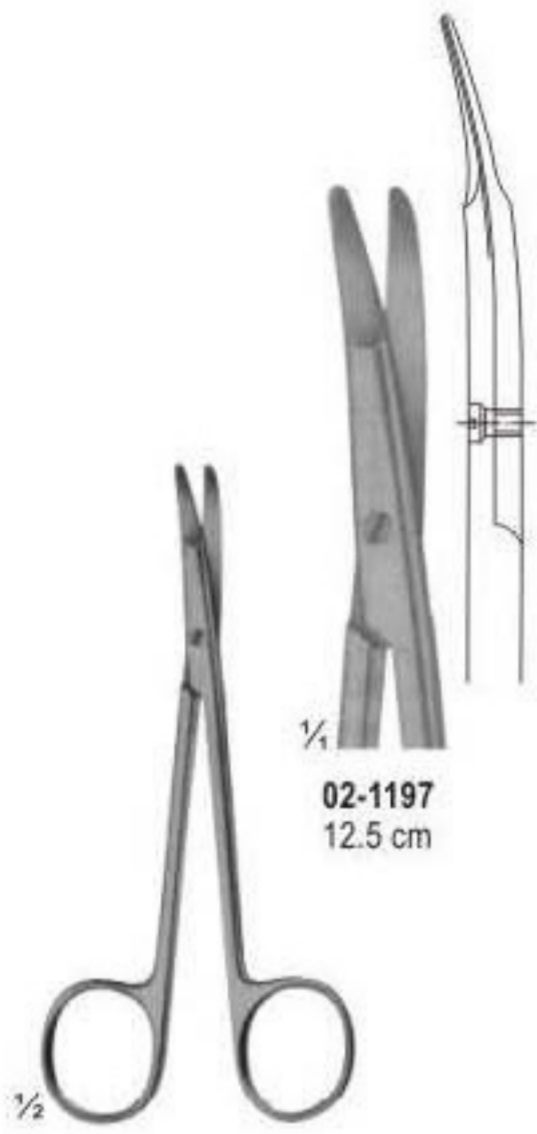

02-1197
12.5 cm

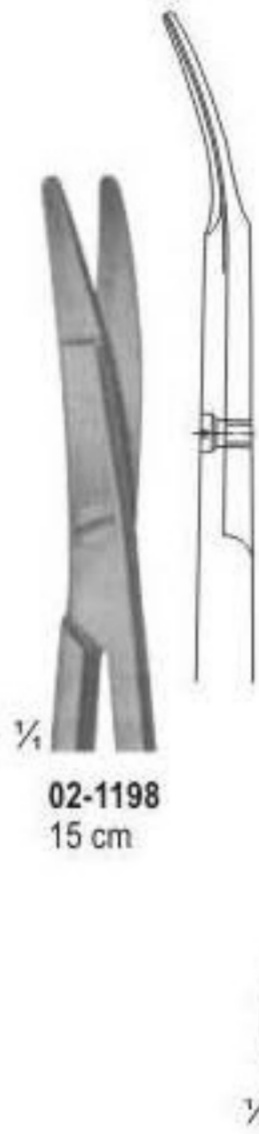

02-1198
15 cm

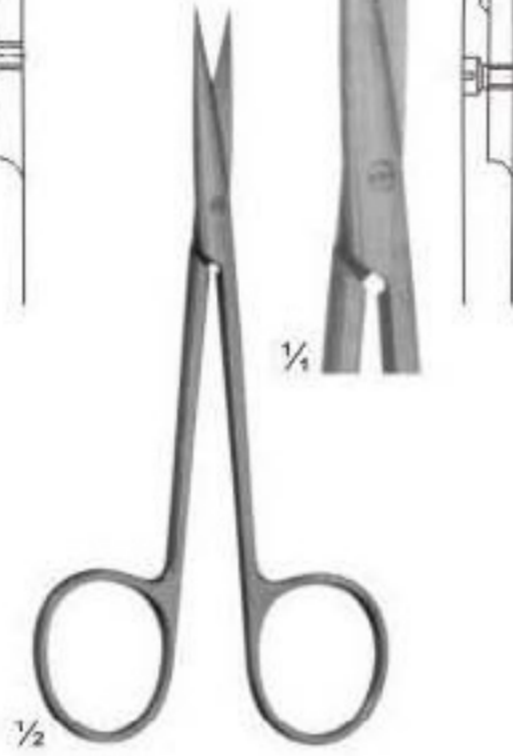

KILNER
02-1199
Fine dissecting scissors
11.5 cm

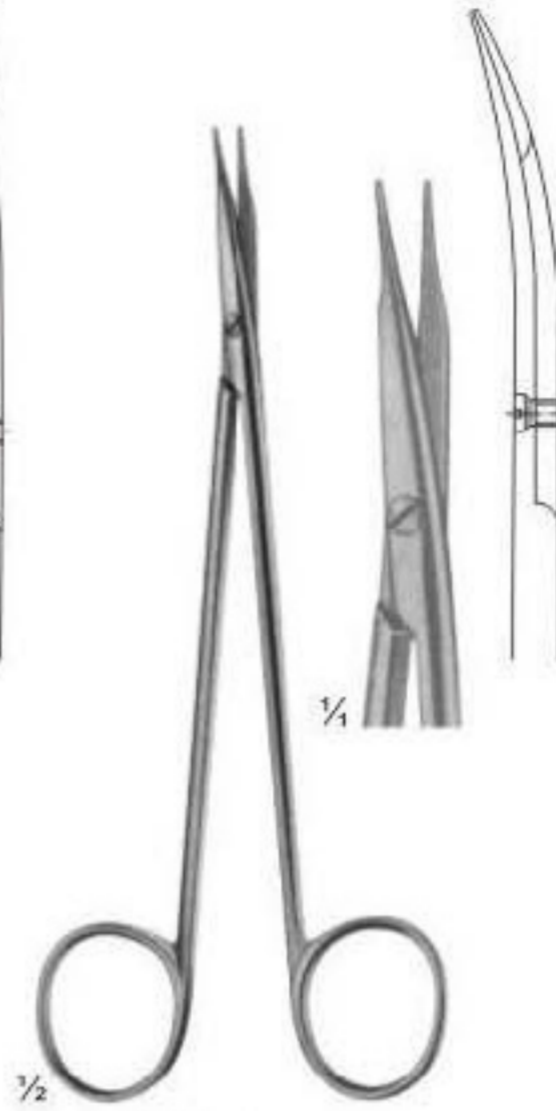

JAMESON
02-1200
Dissecting scissors
15 cm

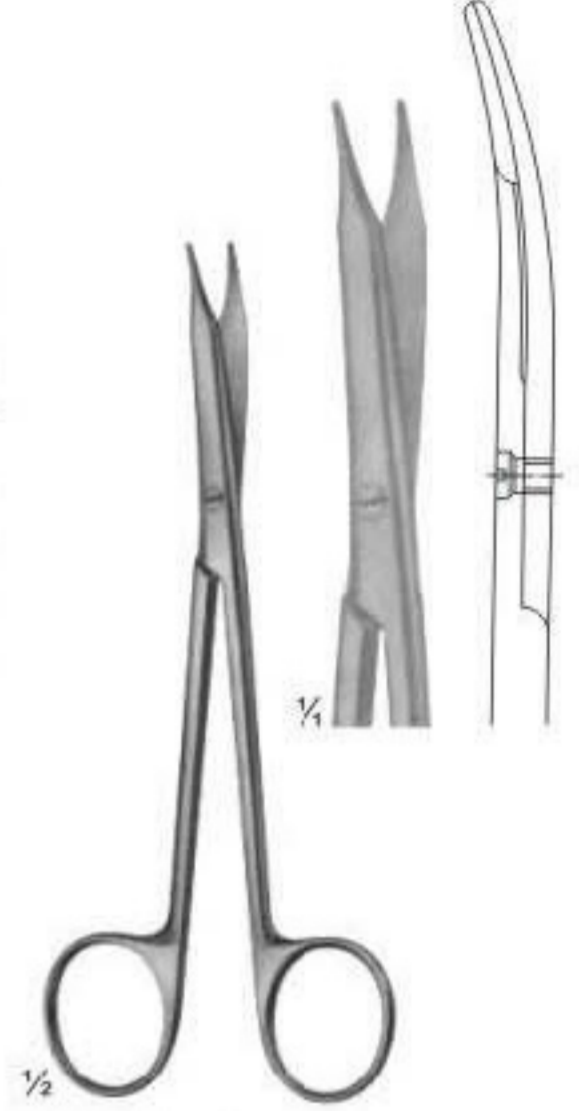

REYNOLDS
Dissecting scissors
02-1201 - 02-1202
02-1201 14.5 cm
02-1202 17.5 cm

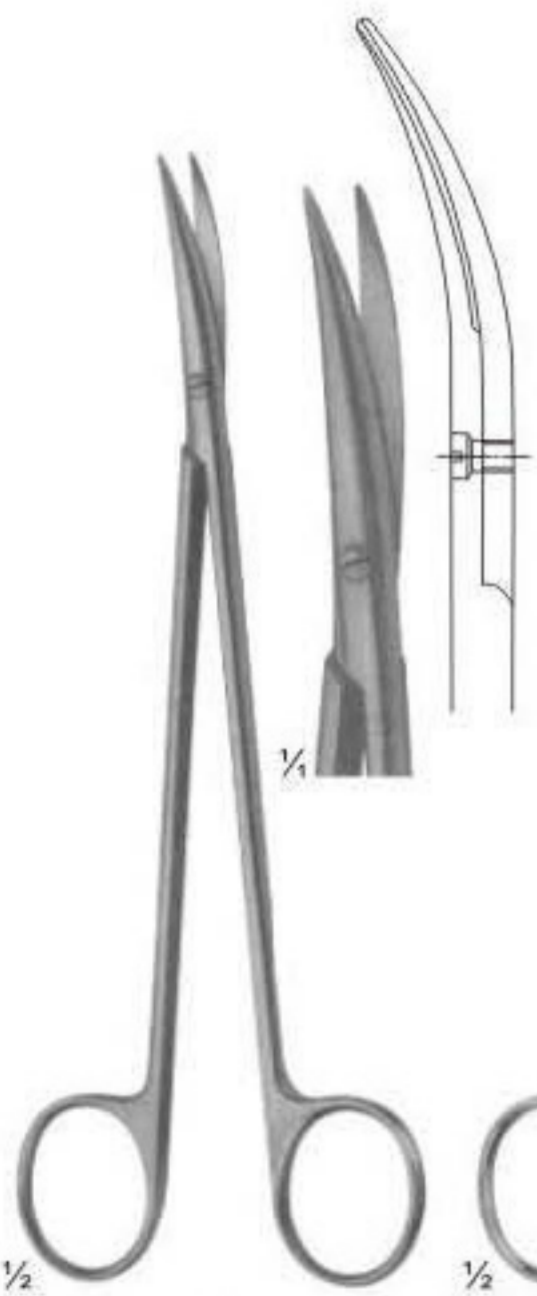

DE BAKHEY
02-1203
Ateriectomy scissors
17.5 cm

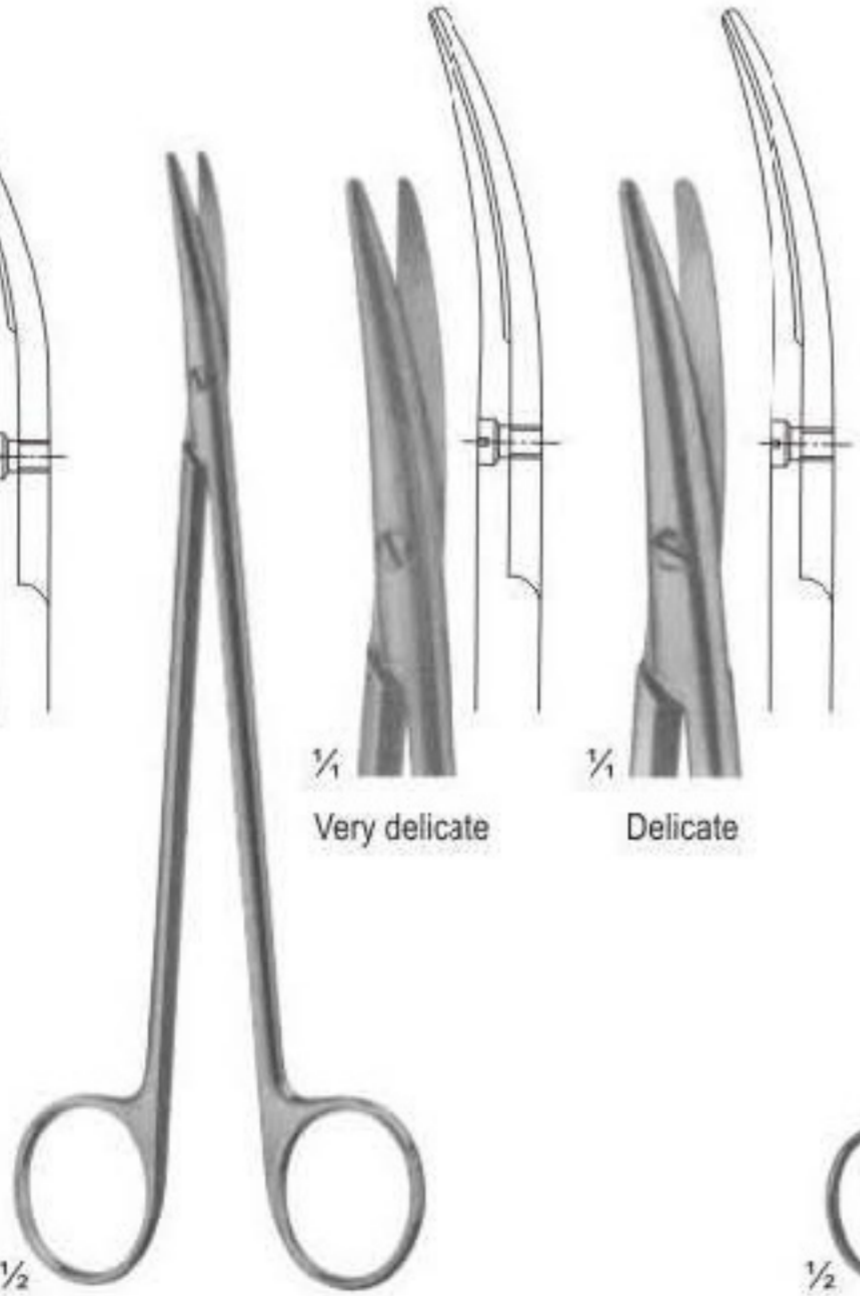

TCENNIS ADSON
02-1204
Dissecting scissors
17.5 cm

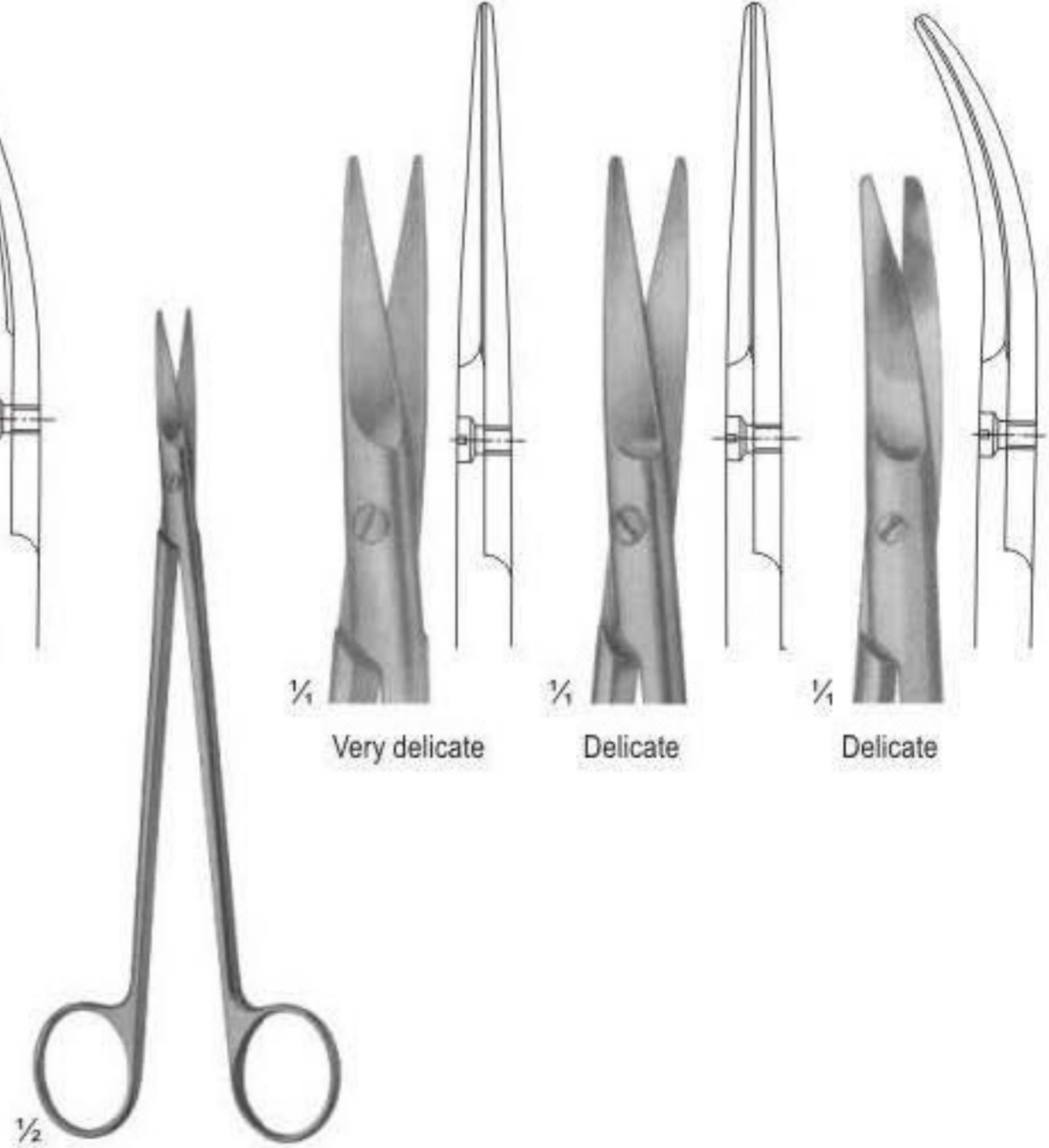

TOENNIS
02-1205
Dissecting scissors
15 cm

Wire And Plate Scissors

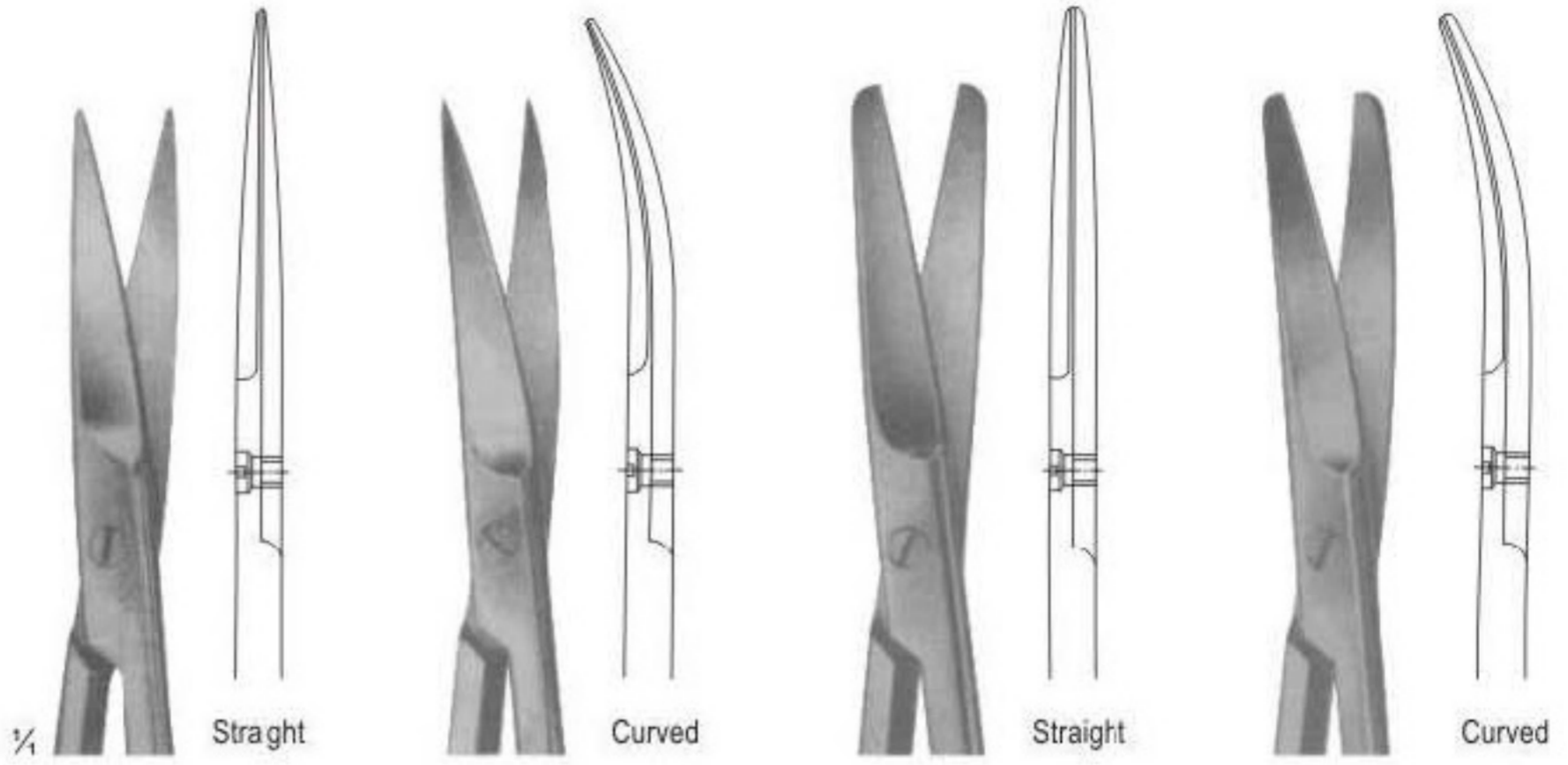

FINE OPERATING SCISSORS
02-1206 - 02-1207
02-1206 12 cm
02-1207 13 cm



BONN
Eye Scissors
02-1208
9 cm

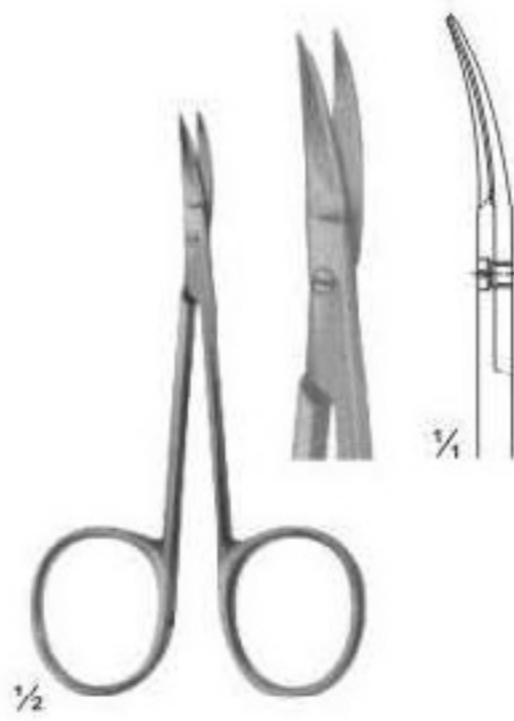

NAIL SCISSORS
02-1209
9 cm

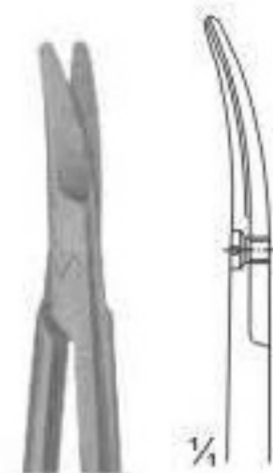
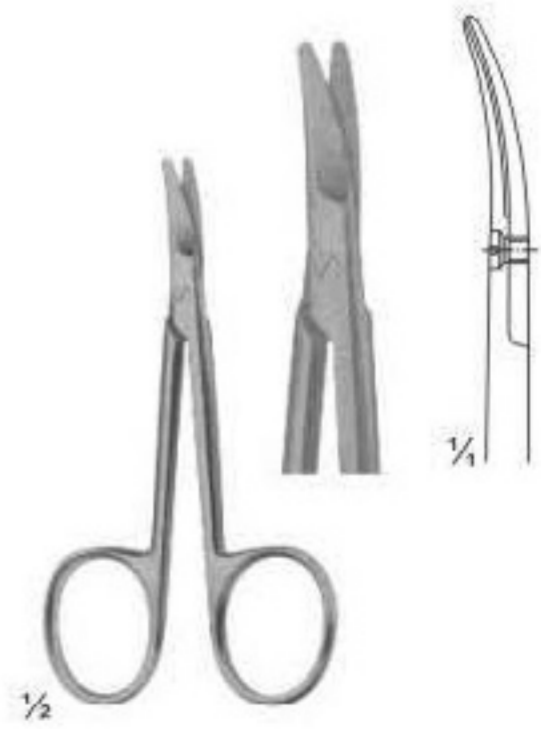

BABY NAIL SCISSORS
02-1210
8.5 cm

Wire And Plate Scissors

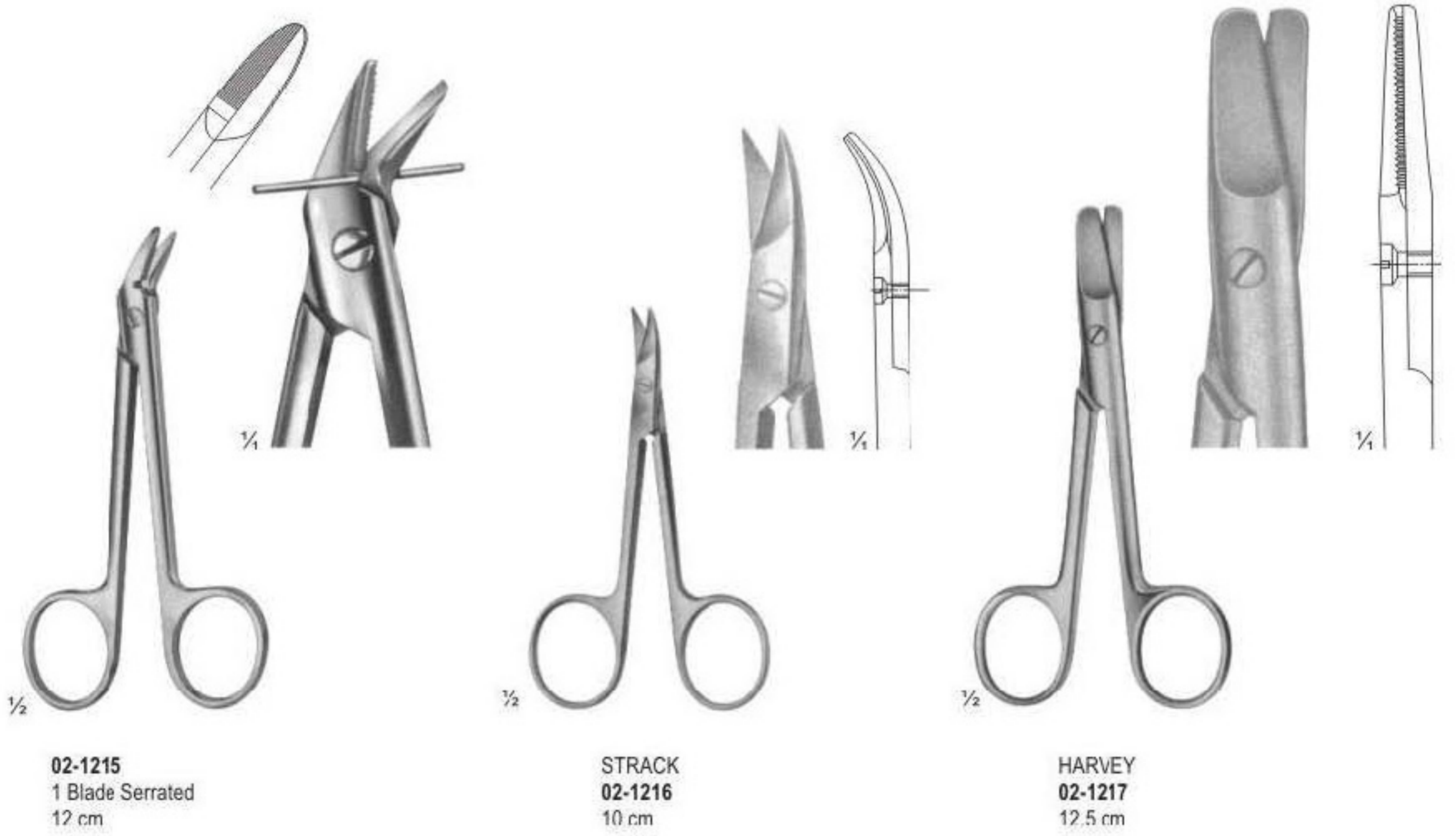
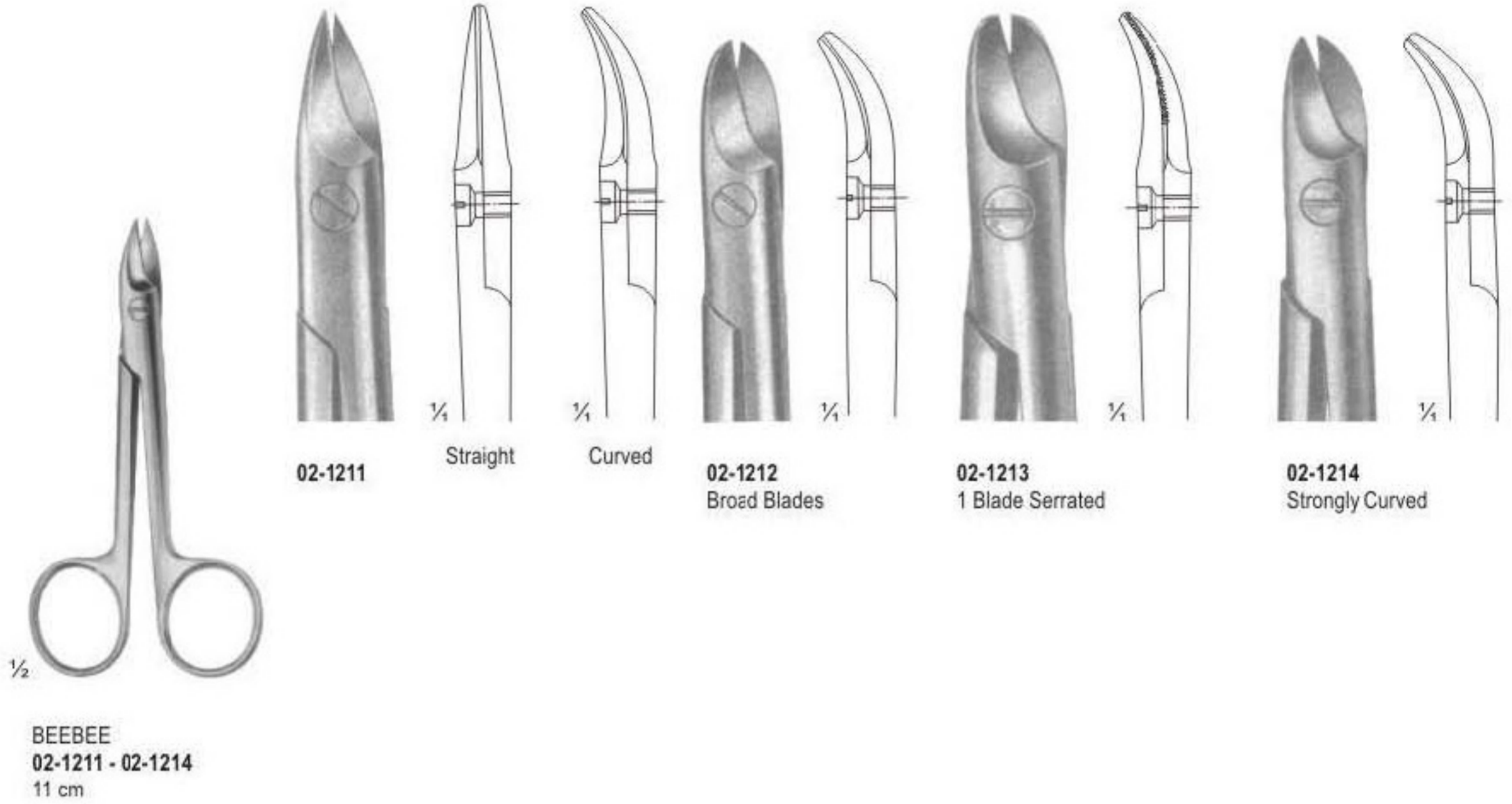

Ligature Scissors



SPENCER
02-1218 - 02-1219
02-1218 9 cm
02-1219 11.5 cm

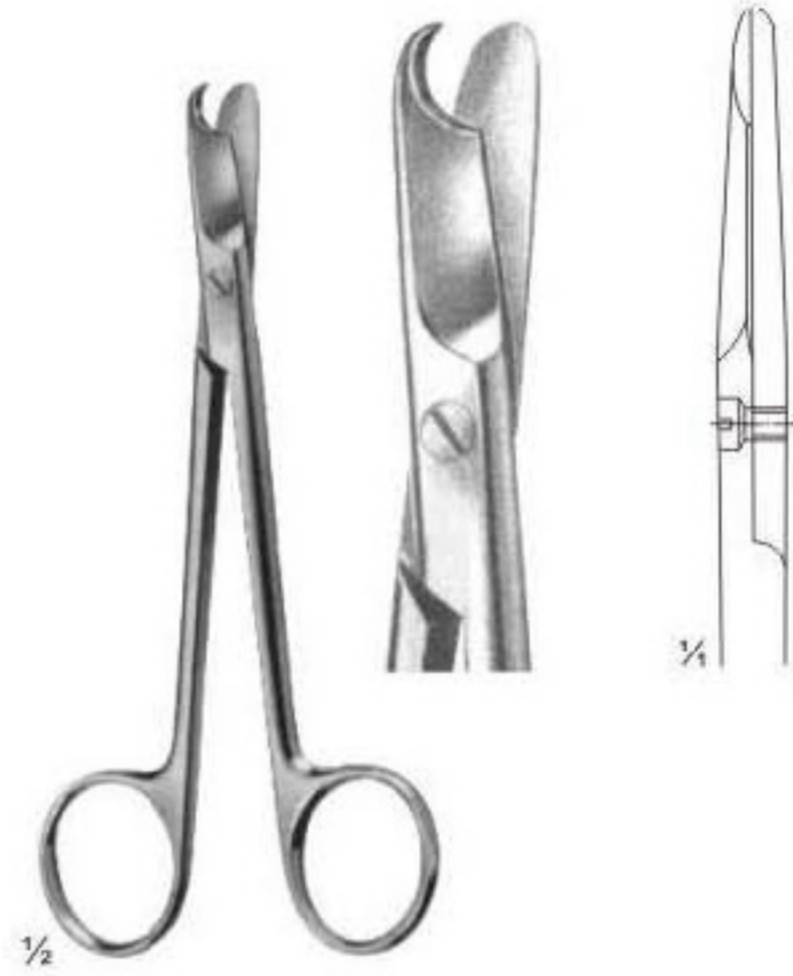

LITTAUER
02-1220
13.5 cm

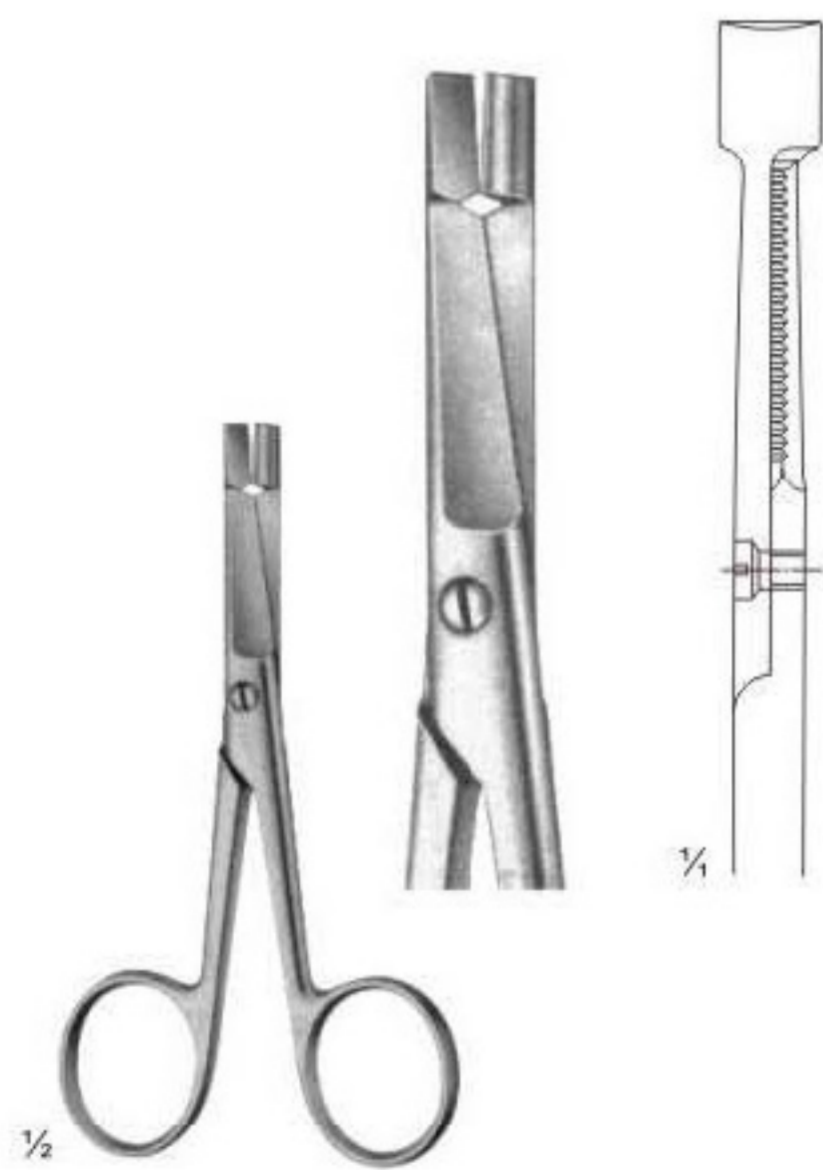

EISELSBERG
02-1221
11.5 cm

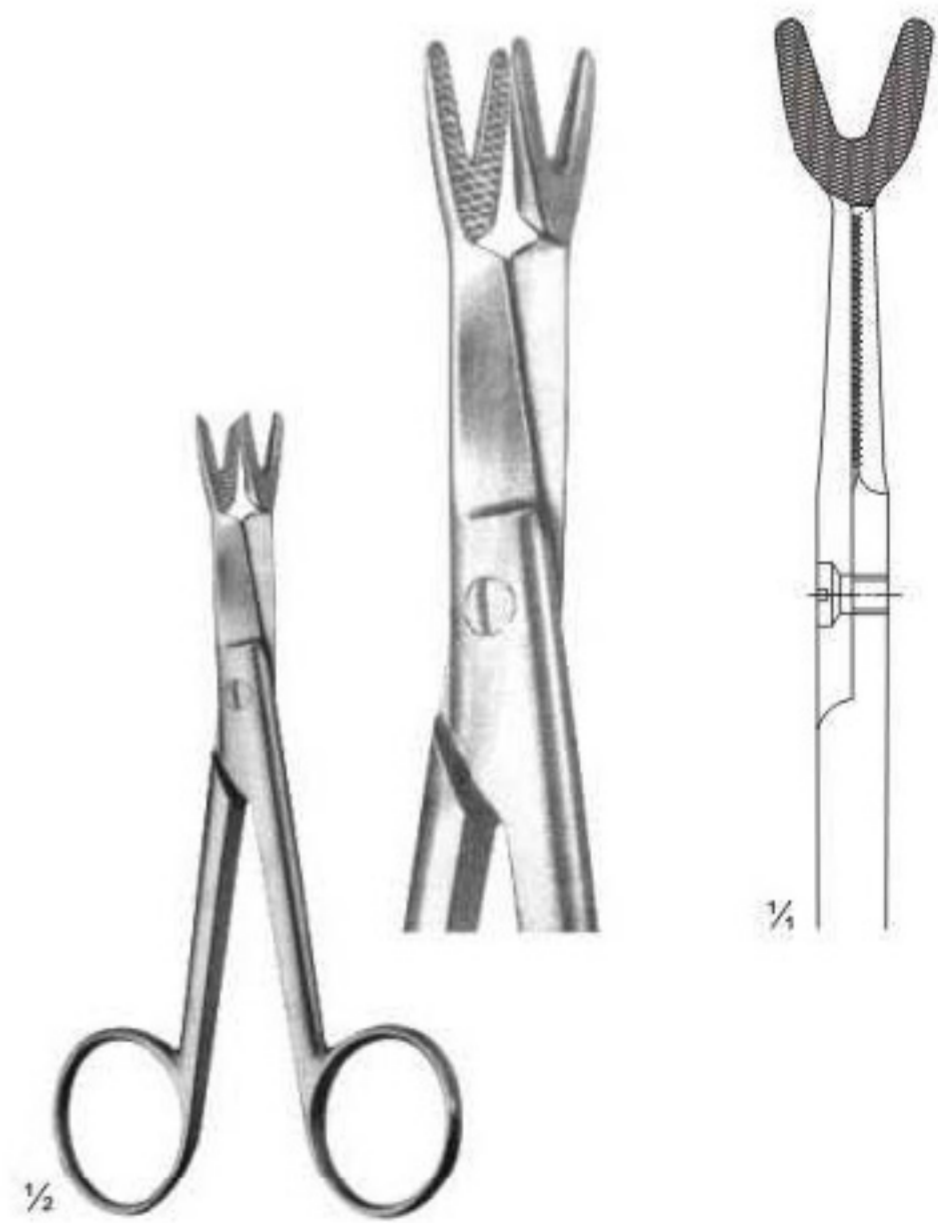

SCHOEMAKER-LOTH
02-1222
12.5 cm

Vessel Scissors

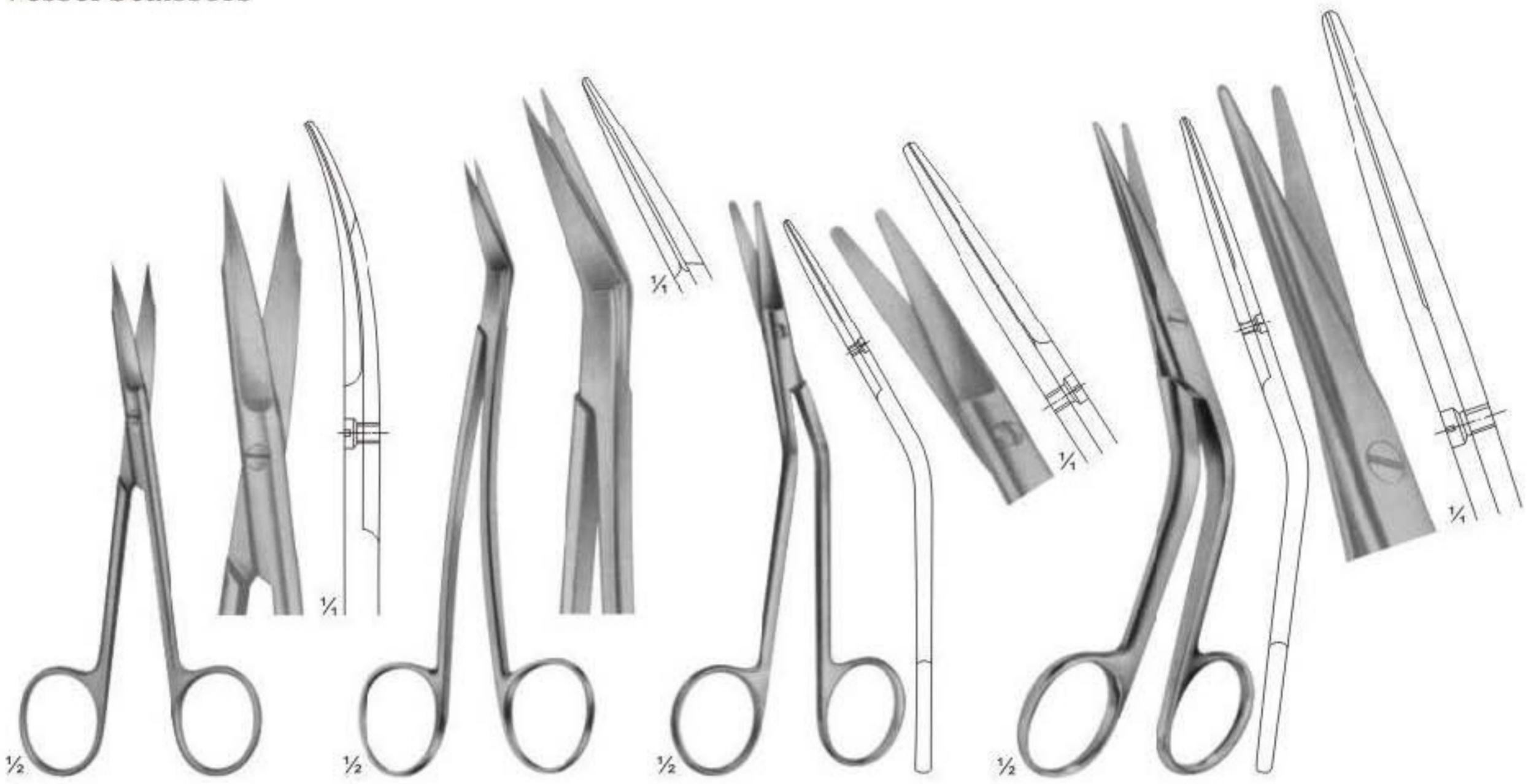

GOLDMAN-FOX
02-1223
One Toothed Cutting Edge
13 cm

LOCKLIN
02-1224
Curved Sideways,
1 Toothed Blade
15.5 cm

FOMON
02-1225
Blades Serrated
14.5 cm

COTTLE
02-1226
16.5 cm

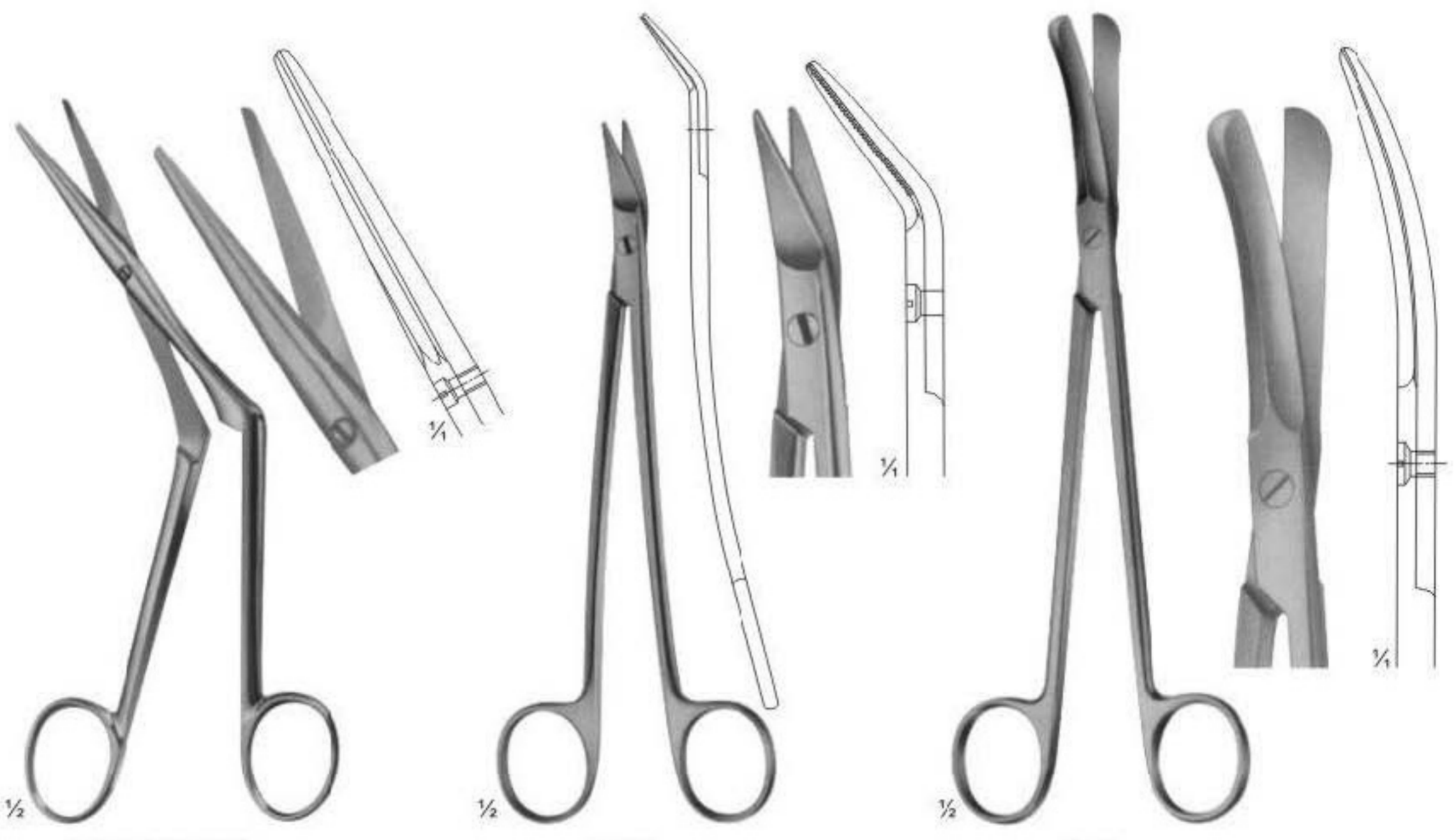

HEYMANN-KNIGHT
02-1227
17.5 cm

DEAN
02-1228
Blades Serrated
17 cm

GOOD
02-1229
19.5 cm

Vessel Scissors

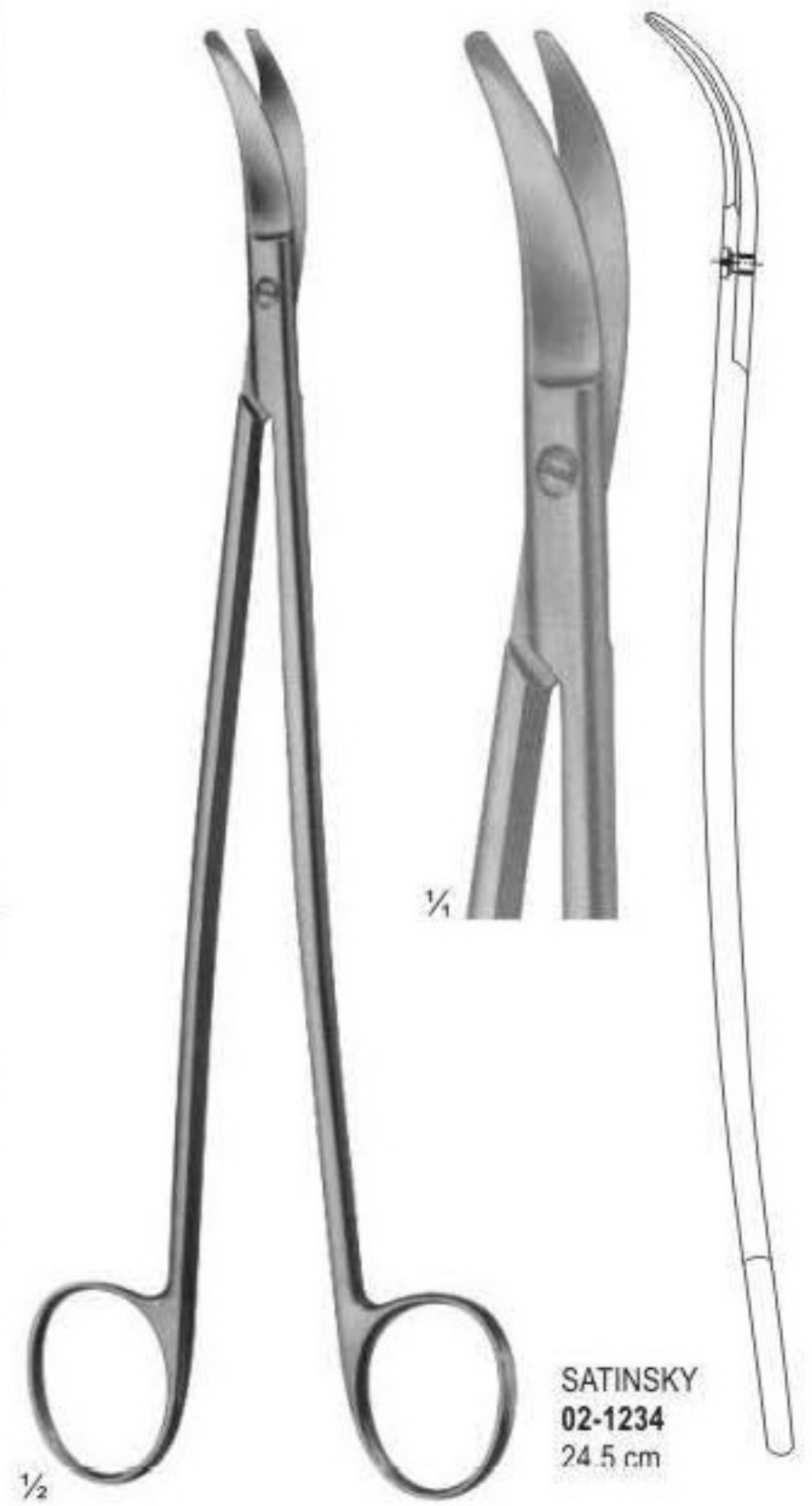
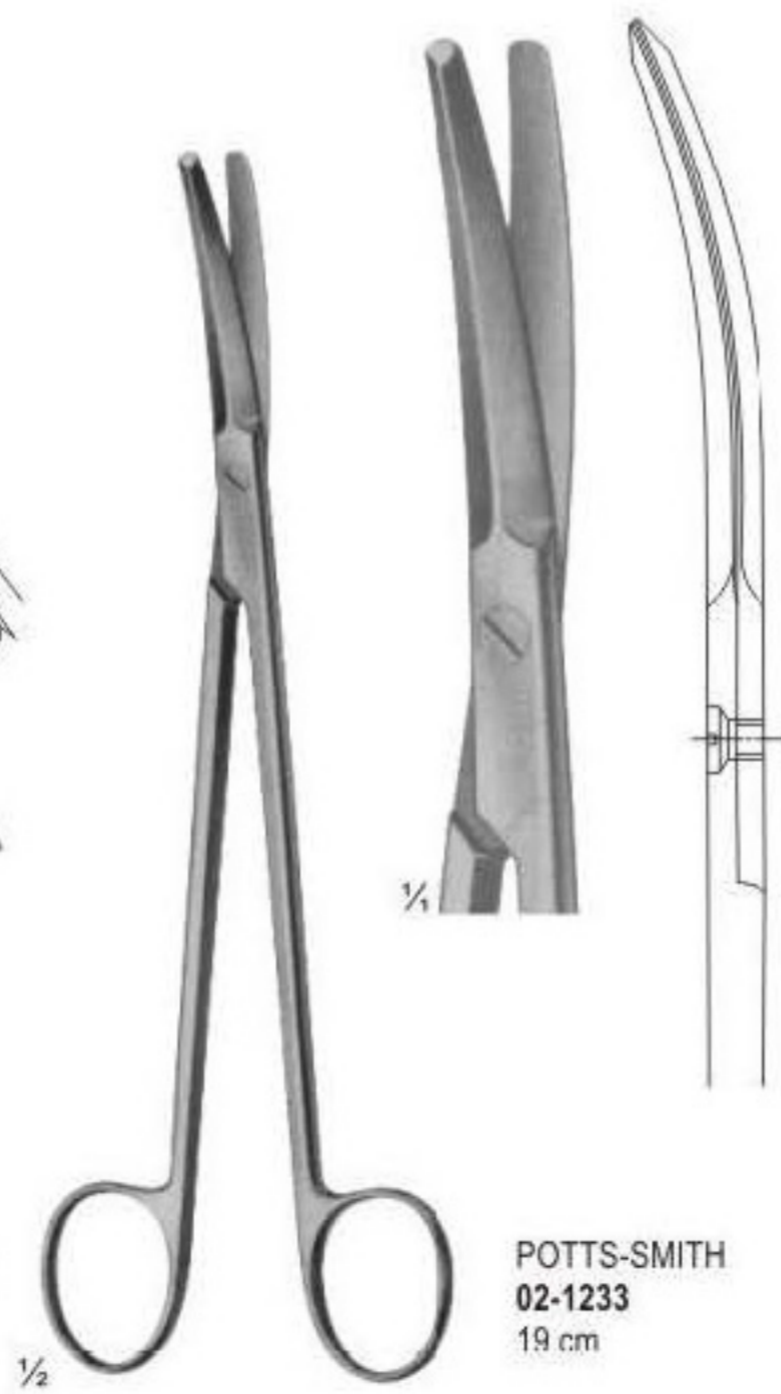
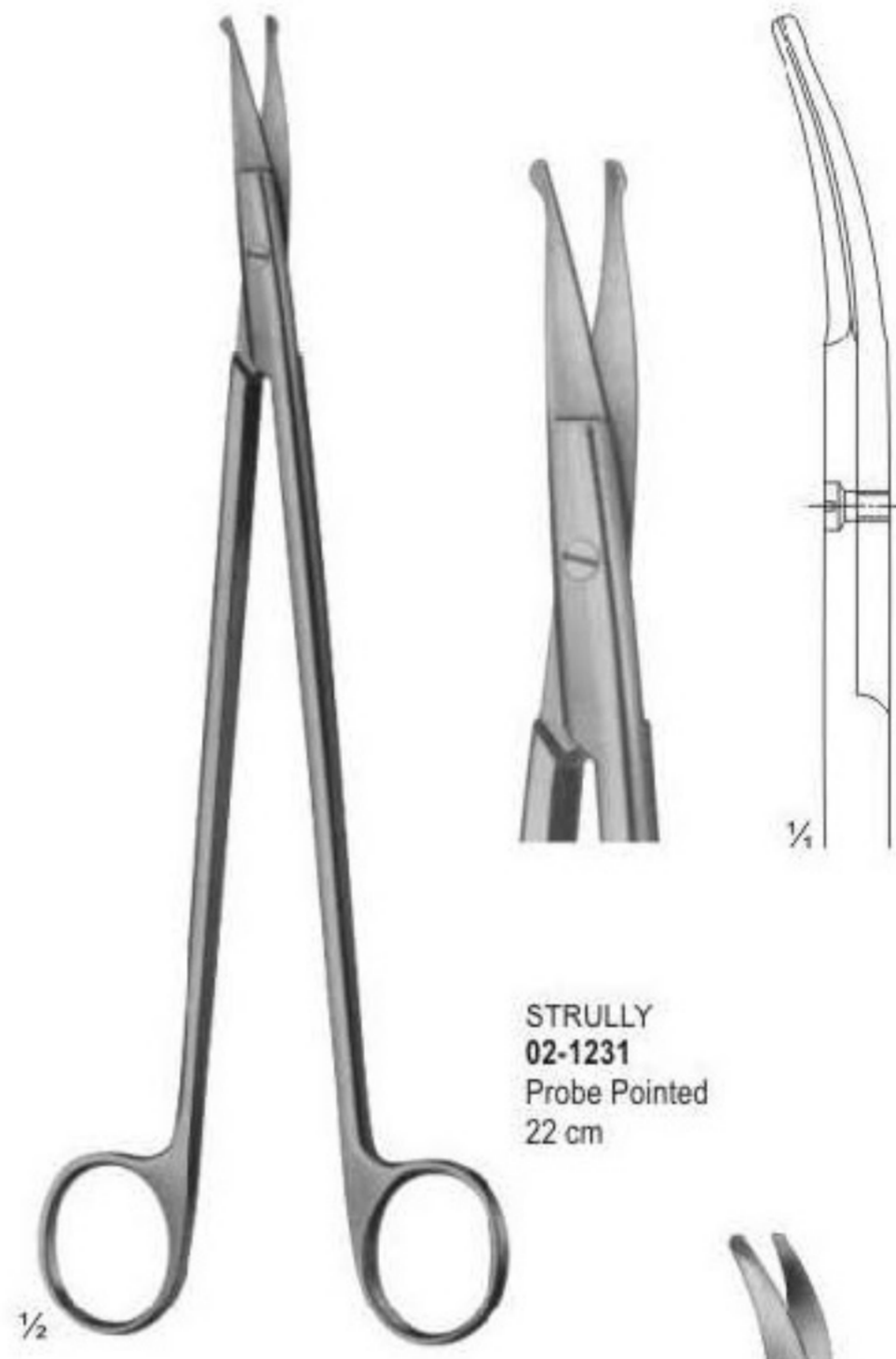
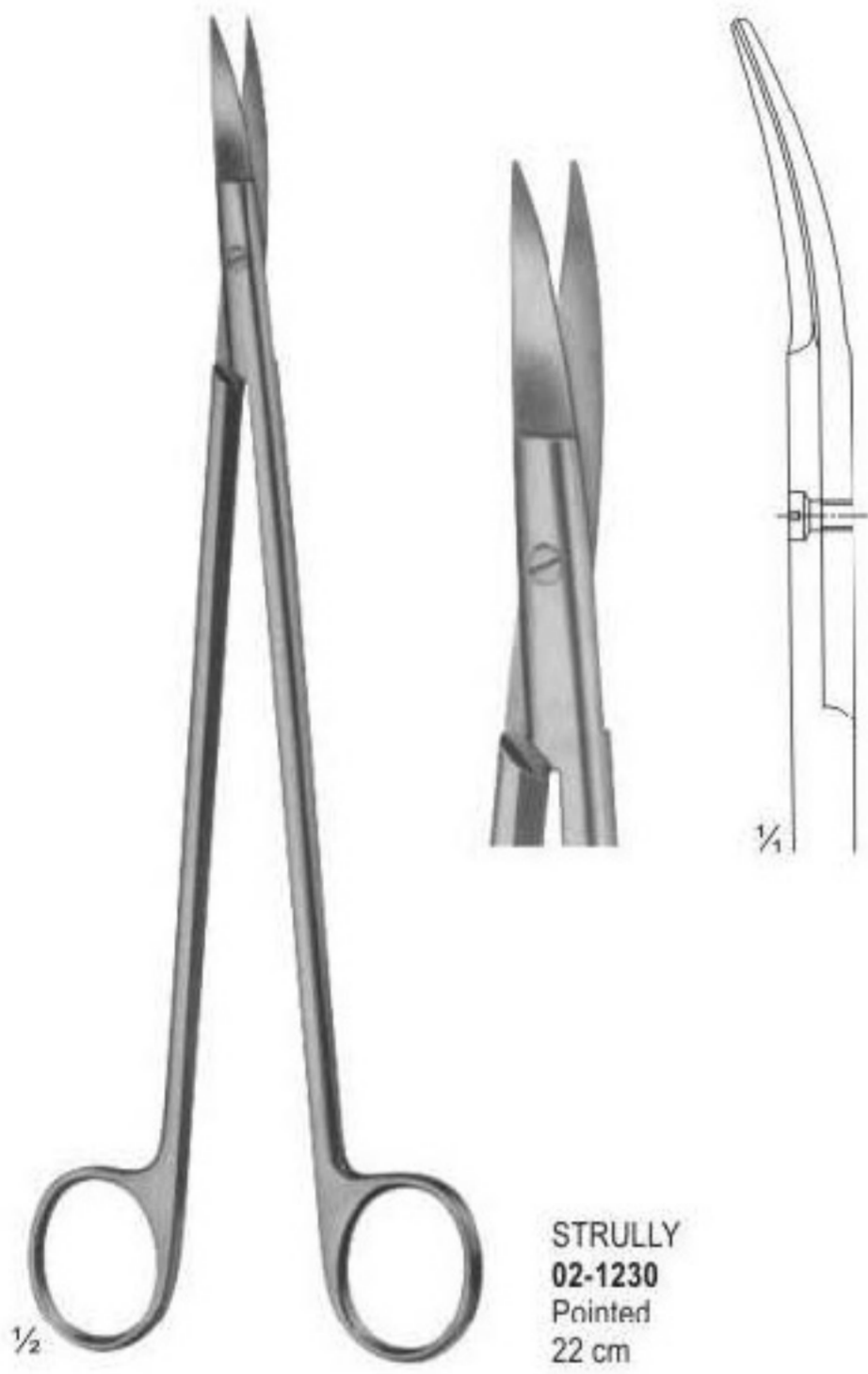

Vessel Scaissors



DIETHRICH
02-1235 - 02-1239



02-1235
19 cm
25°



02-1236
18.5 cm
45°



02-1237
17.5 cm
60°



02-1238
17.5 cm
90°



02-1239
17.5 cm
120°



MIKRO-HEGEMANN
02-1240 - 02-1244
18.5 cm



02-1240
25°



02-1241
45°



02-1242
60°



02-1243
90°



02-1244
120°

Vessel Scissors



POTTS-SMITH
02-1245 - 02-1249
19 cm



02-1245
60°



02-1246
60°



02-1247
40°



02-1248
25°



02-1249
1/4

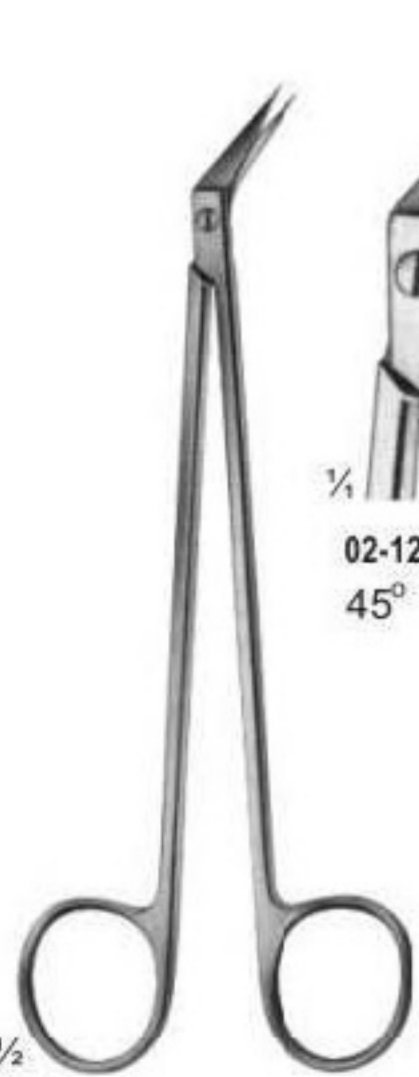

DE BAKEY
02-1250 - 02-1251
15.5 cm



02-1250
45°



02-1251
60°

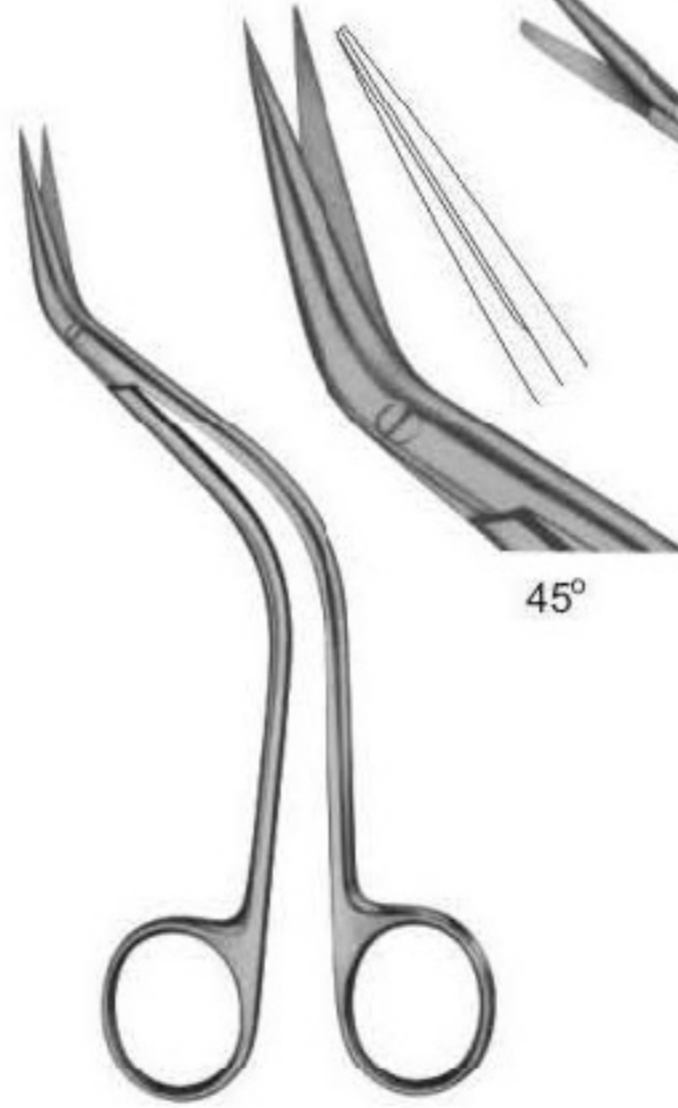

DEBAKEY
02-1252
15.5 cm



OLIVECRONA
Dura Scissors
02-1253
12 cm

Bowel Scissors, Cartilage Scissors



DAMMSCHERE
02-1254
Bowel Scissors
21 cm

DAMMSCHERE
02-1255
Bowel Scissors
21 cm

LLOYD-DAVIES
(GOLIGHER'S)
02-1256
Rectal Scissors
25.5 cm

STELZNER
02-1257
Rectal Scissors
31 cm

Ligature Scissors



02-1258
14.5 cm



02-1259
18 cm

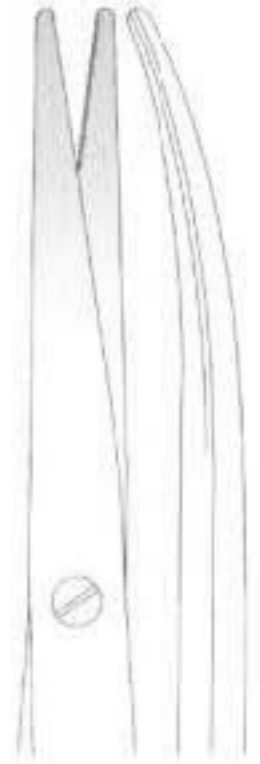

02-1260
20.5 cm

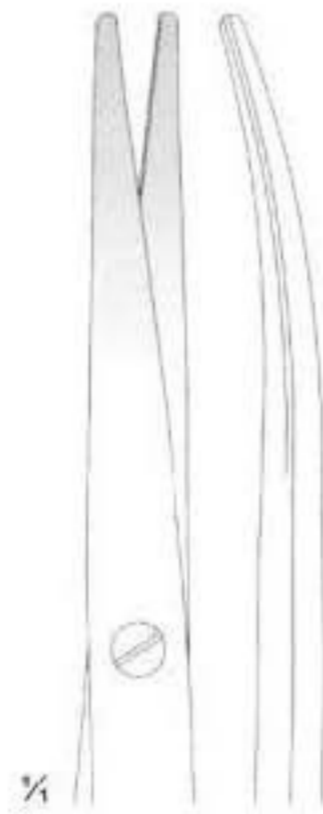

02-1261
23 cm

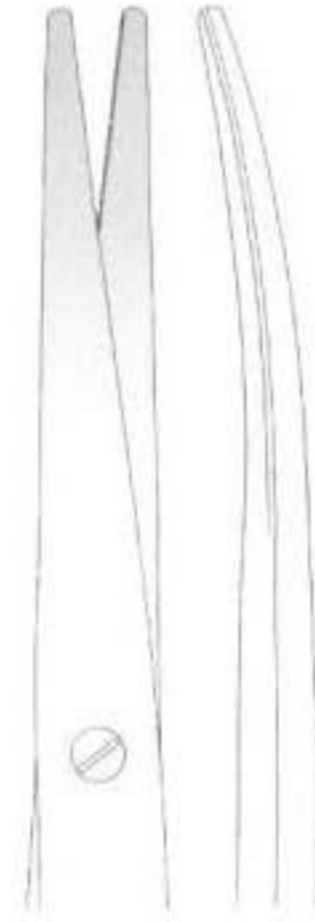

02-1262
25 cm

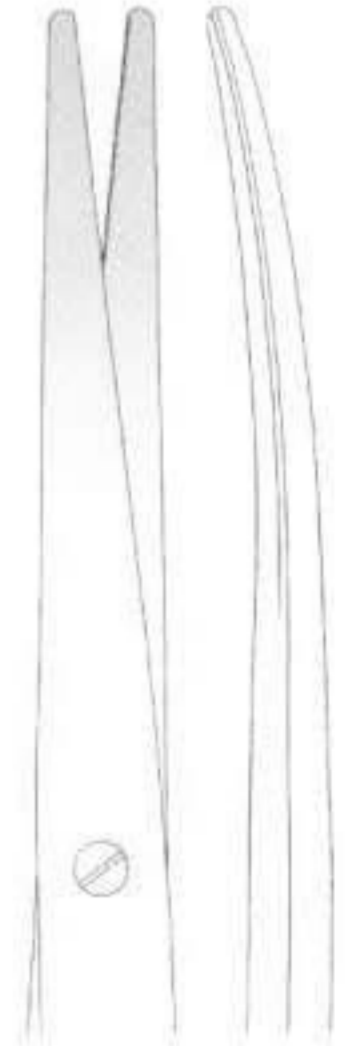

02-1263
30 cm

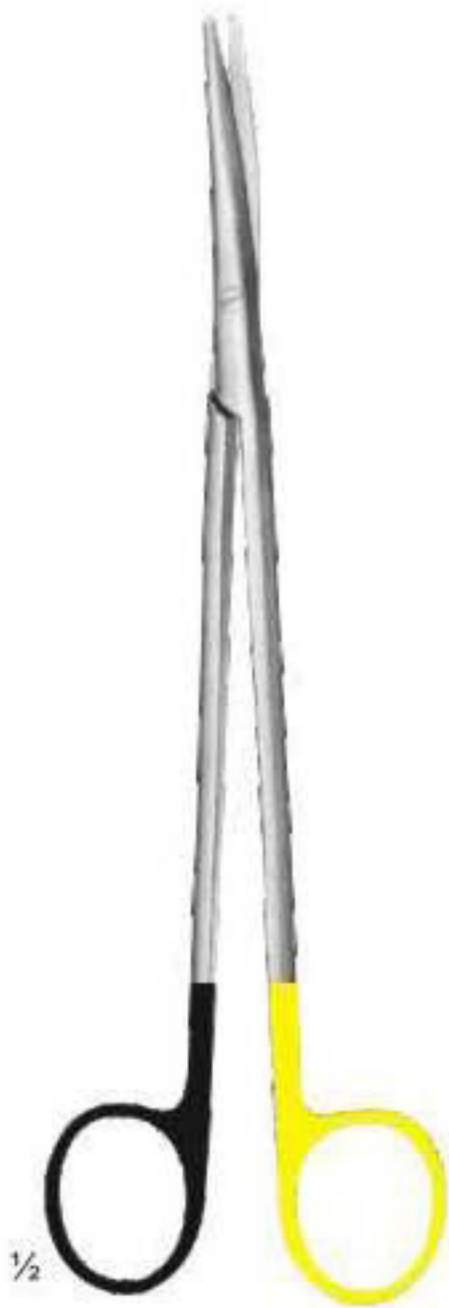

LIGATURE SCISSORS
02-1258 - 02-1263
for synthetic suture material,
one toothed cutting edge

Ligature Scissors



LIGATURE SCISSORS
02-1264 · 02-1266
for synthetic suture material,
one toothed cutting edge

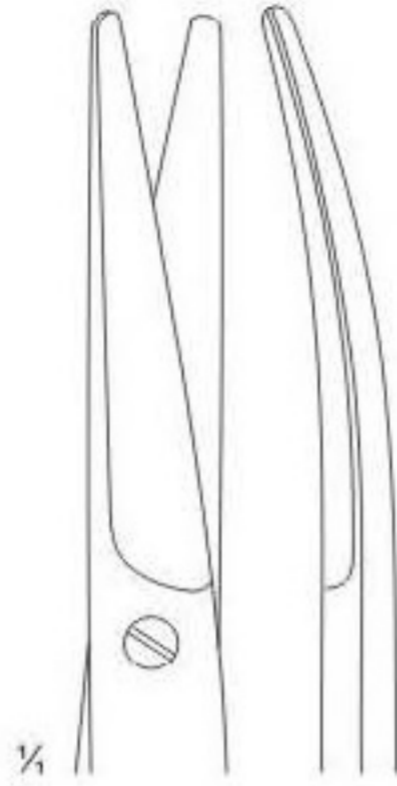

02-1264
14.5 cm

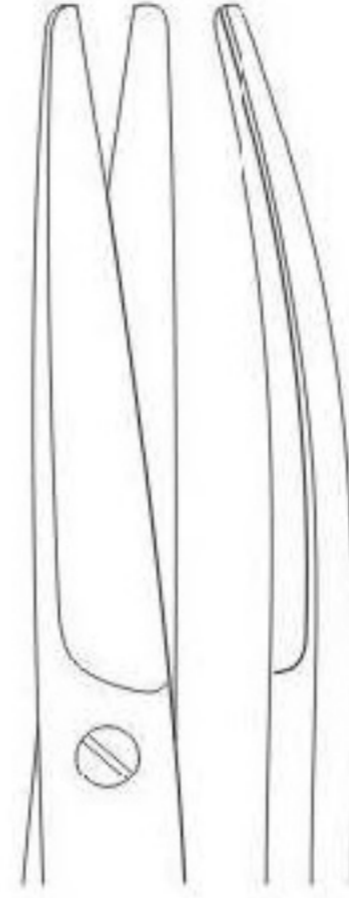

02-1265
17 cm

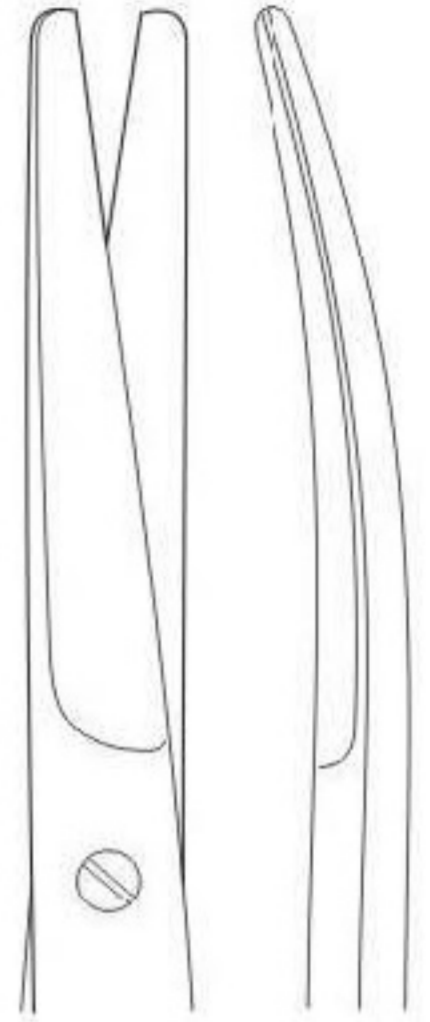

02-1266
23 cm



IRIS
02-1267
11.5 cm

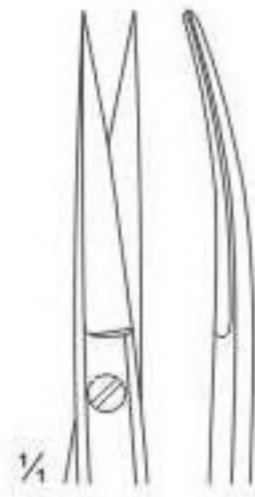

Dissecting Scissors

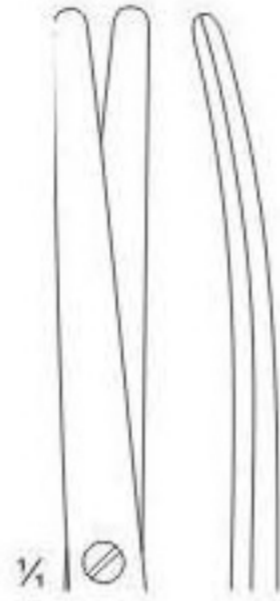

02-1268
18 cm

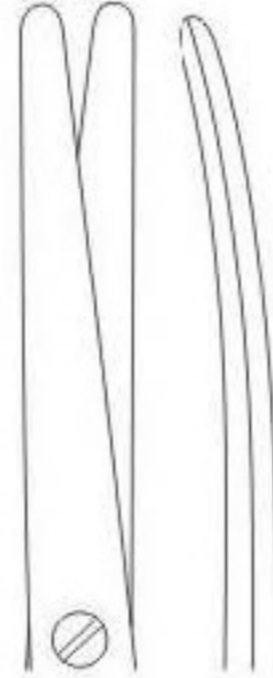

02-1269
20 cm

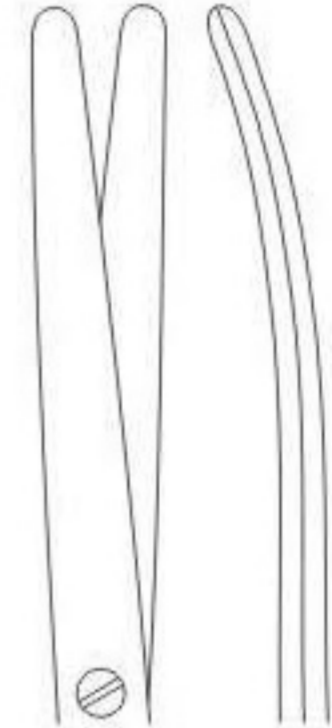

02-1270
23 cm

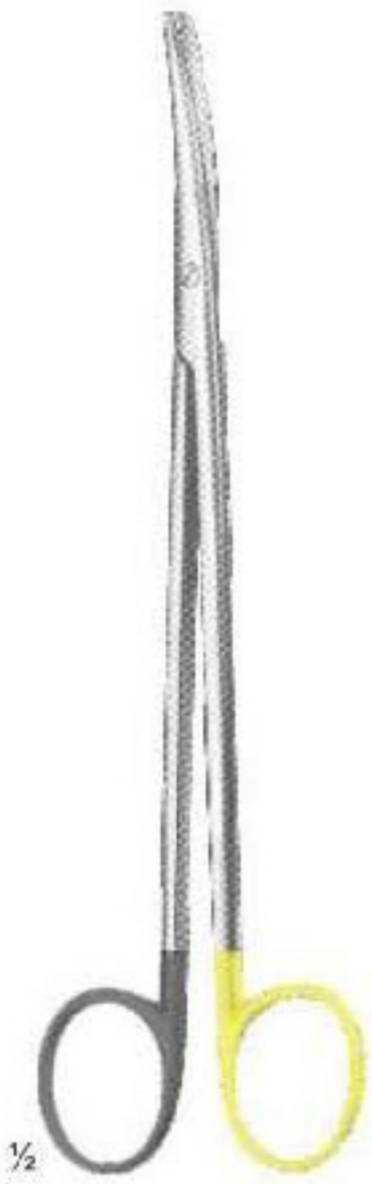

1/2

METZENBAUM
02-1268 - 02-1273

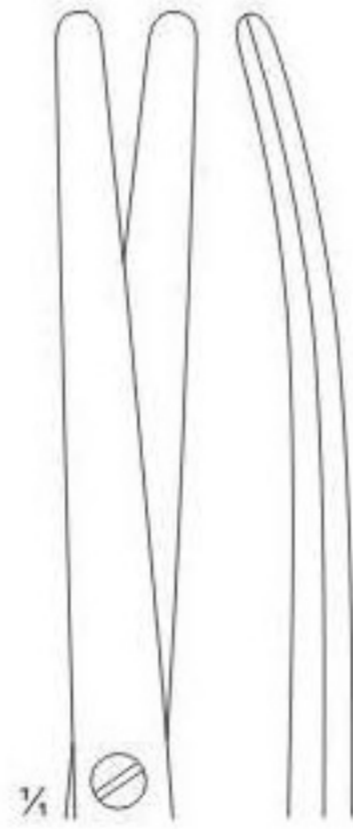

02-1271
26 cm

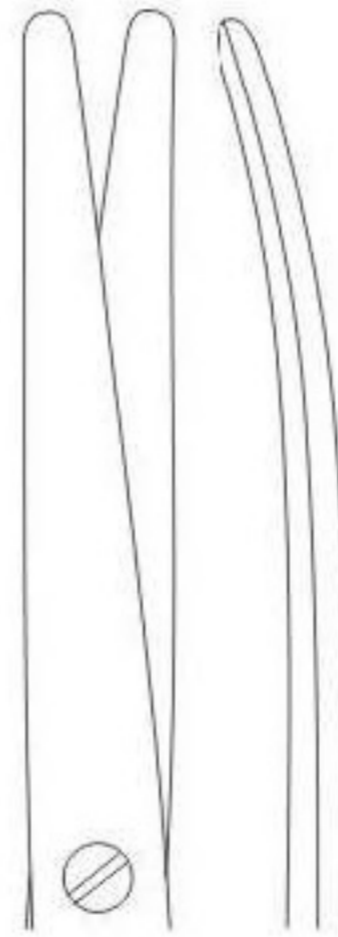

02-1272
28.5 cm

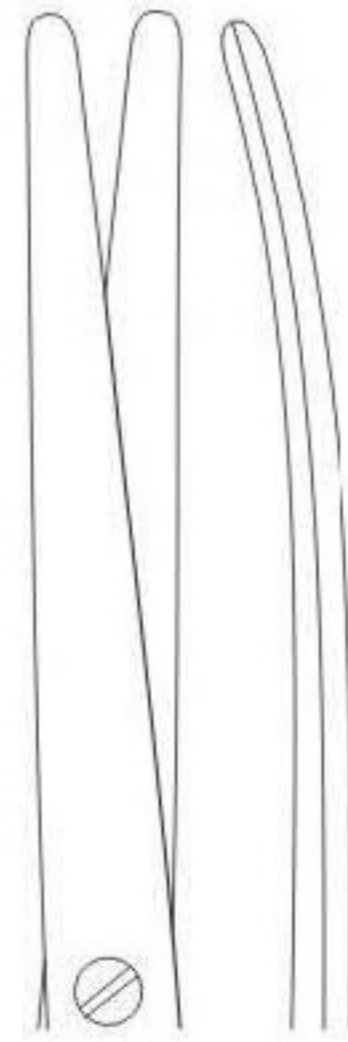

02-1273
31 cm

Aquila-Scissors

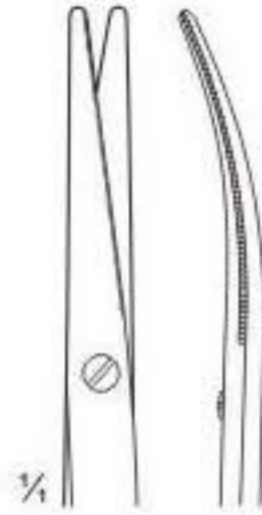

02-1274
12 cm

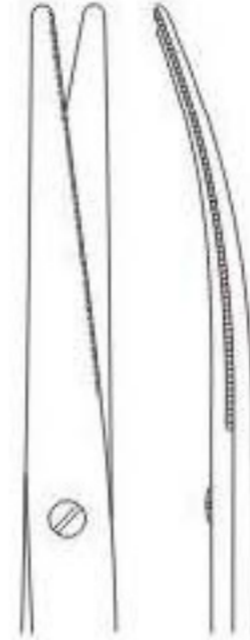

02-1275
18 cm

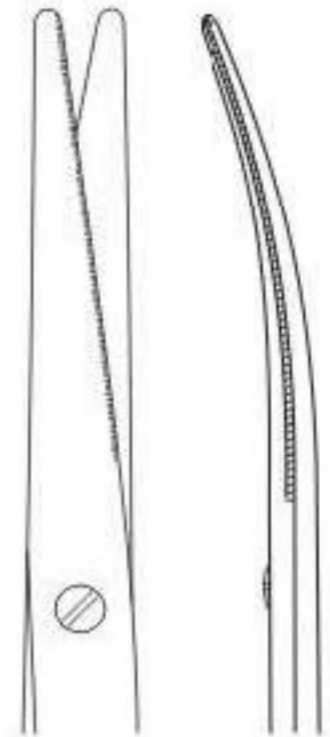

02-1276
20 cm

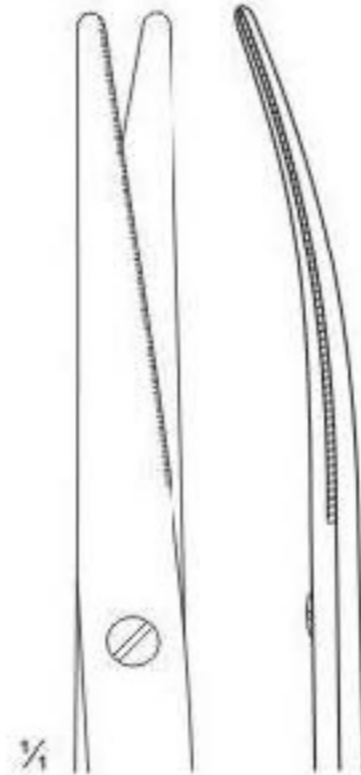

02-1277
23 cm

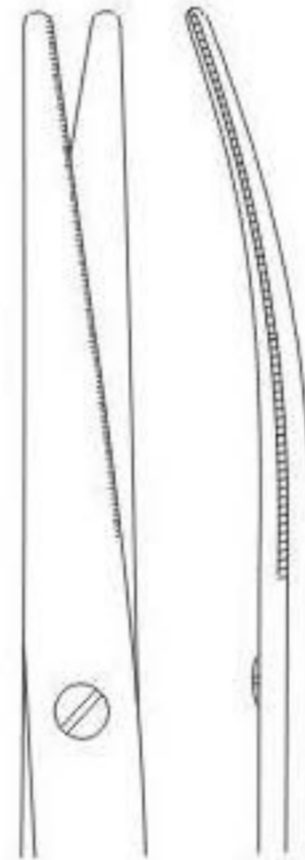

02-1278
25 cm

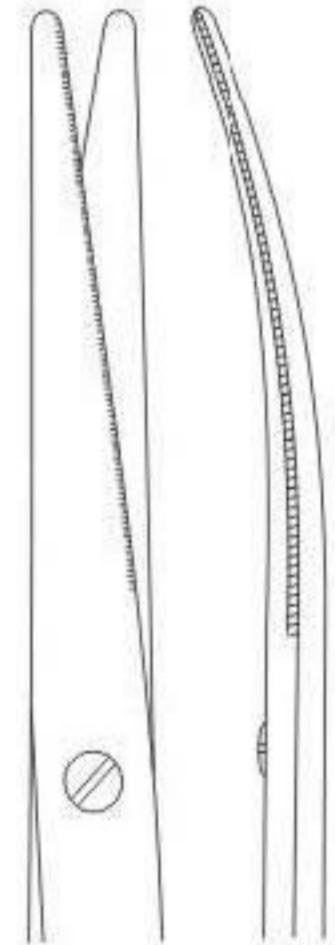

02-1279
30 cm



Metzenbaum-Aquila
02-1274 - 02-1279
one toothed cutting edge /
one cutting edge with knife cut

Aquila-Scissors



1/2

Metzenbaum-Aquila-Fino
02-1280 - 02-1281
one toothed cutting edge/
one cutting edge with knife cut

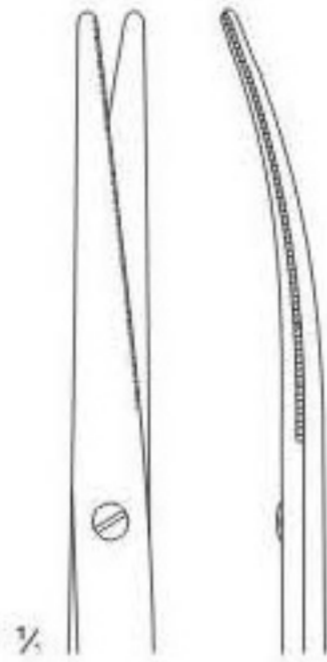

1/2

02-1280
14 cm

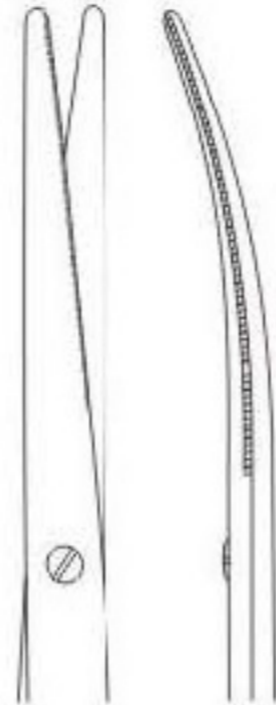

1/2

02-1281
18 cm



1/2

TÖNNIS-ADSON-AQUILA
02-1282
17.5 cm
one toothed cutting edge/
one cutting edge with knife cut

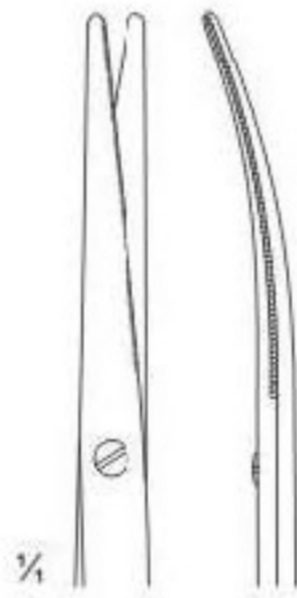

1/2



1/2

MAYO-LEXER-AQUILA
02-1283
17.5 cm
one toothed cutting edge/
one cutting edge with knife cut

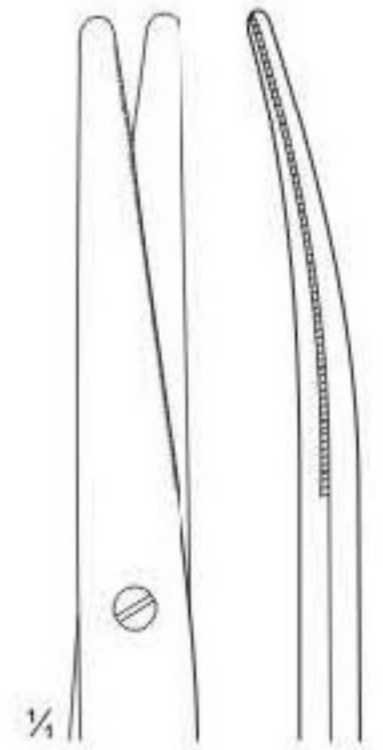

1/2

Operating Scissors

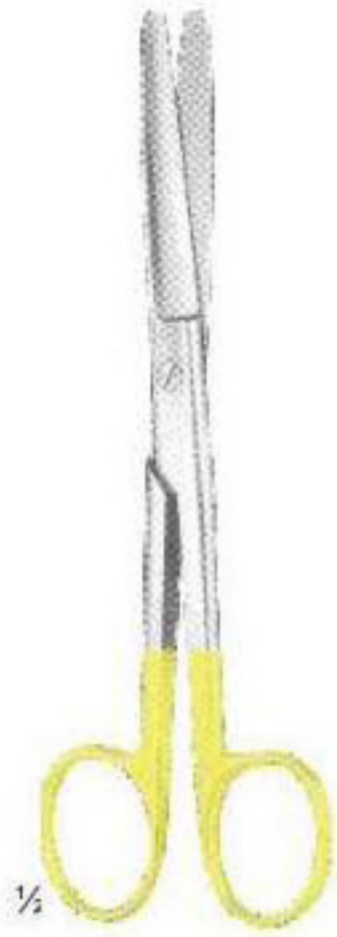

OPERATING SCISSORS
02-1284 - 02-1286
14.5 cm

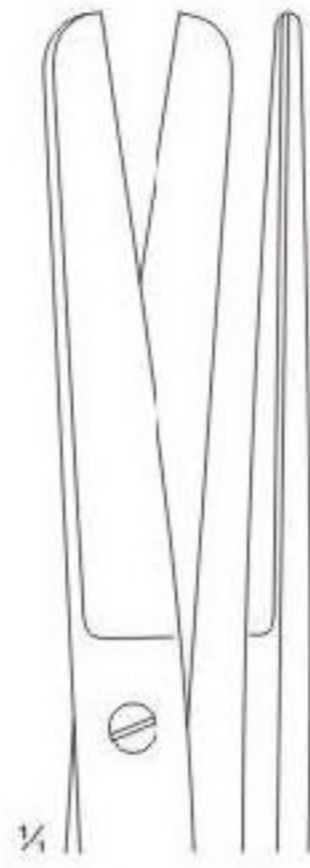

02-1284

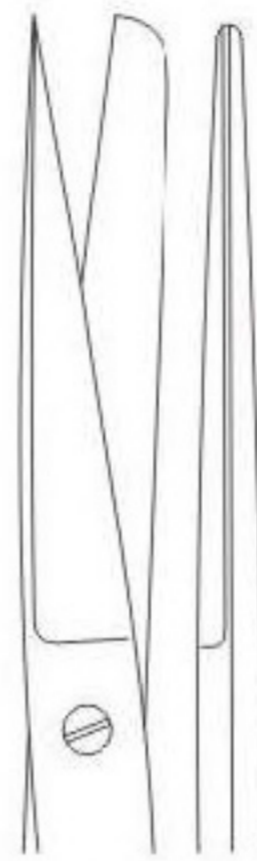

02-1285

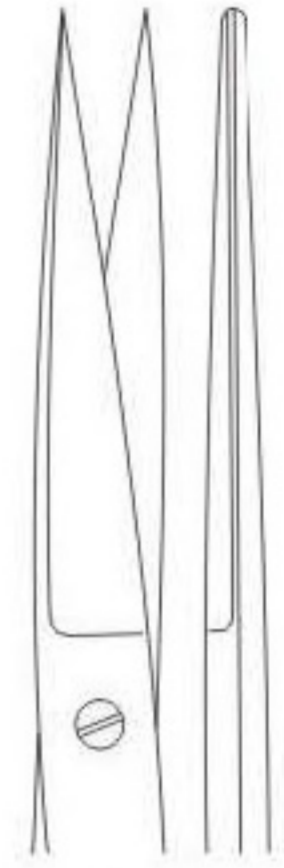

02-1286



OPERATING SCISSORS
02-1287 - 02-1289
14.5 cm

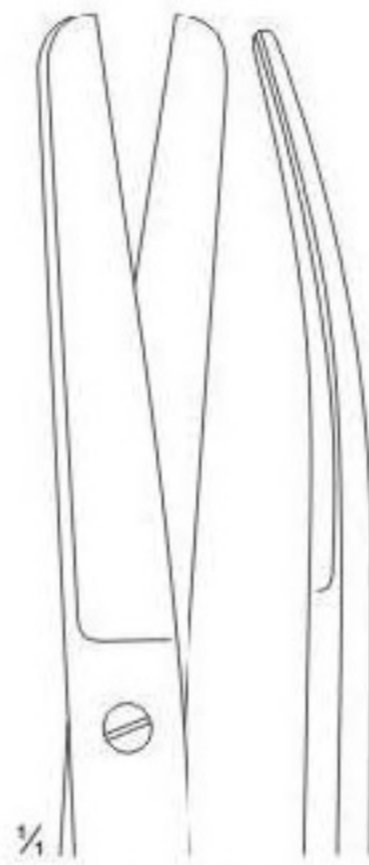

02-1287

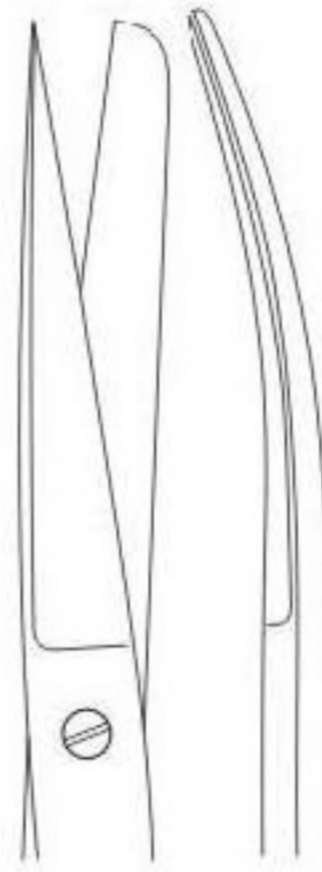

02-1288

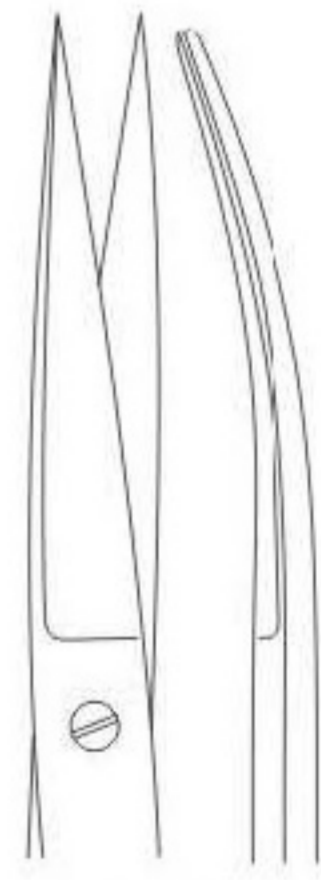

02-1289

Operating Scissors

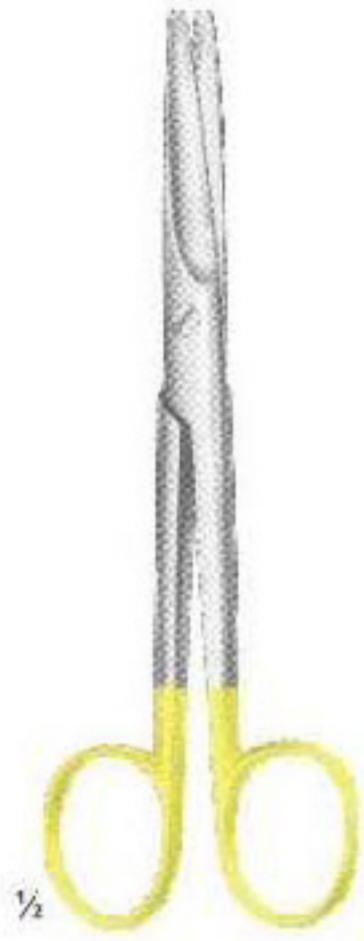

MAYO
02-1290 - 02-1292

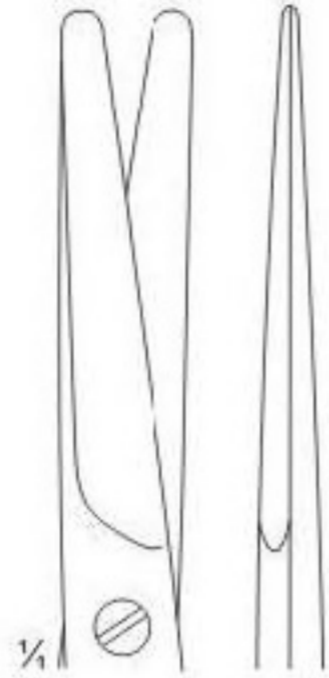

02-1290
14.5 cm

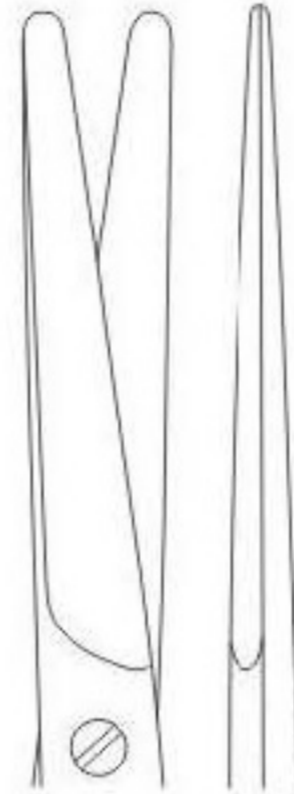

02-1291
17 cm

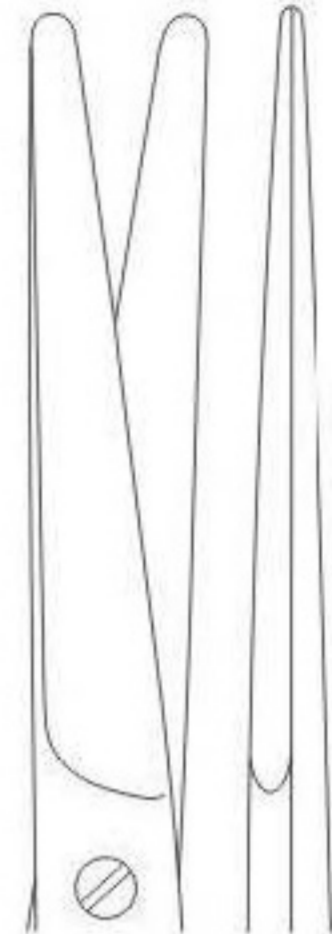

02-1292
23 cm

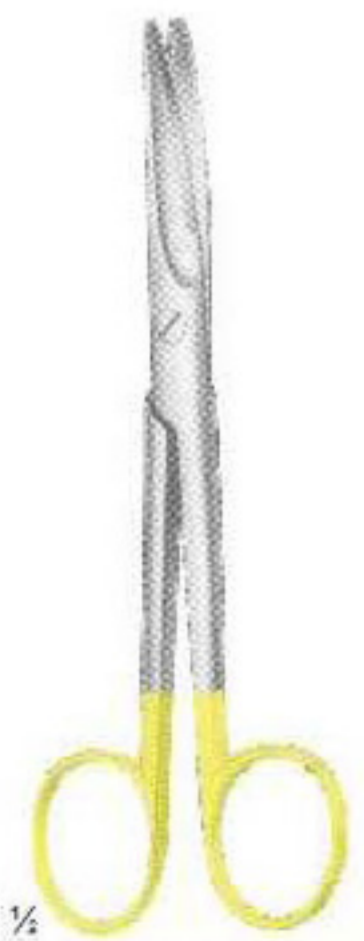

MAYO
02-1293 - 02-1295

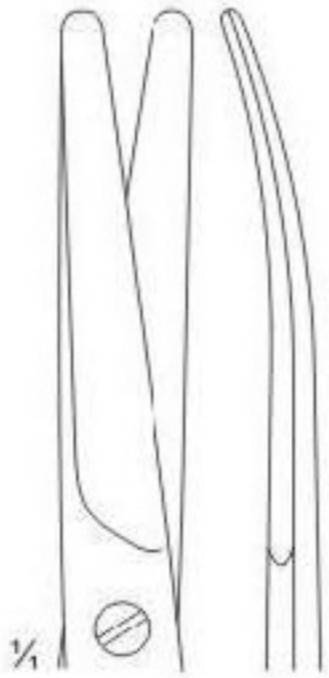

02-1293
14.5 cm

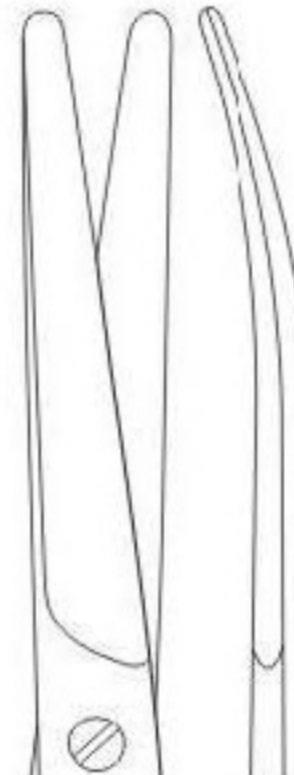

02-1294
17 cm

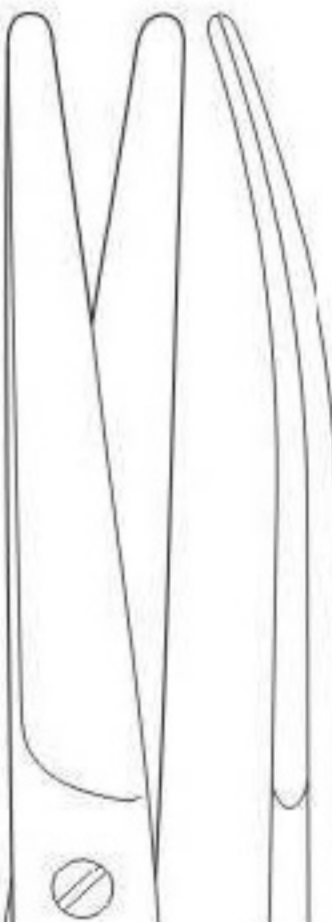

02-1295
23 cm

Dissecting Scissors

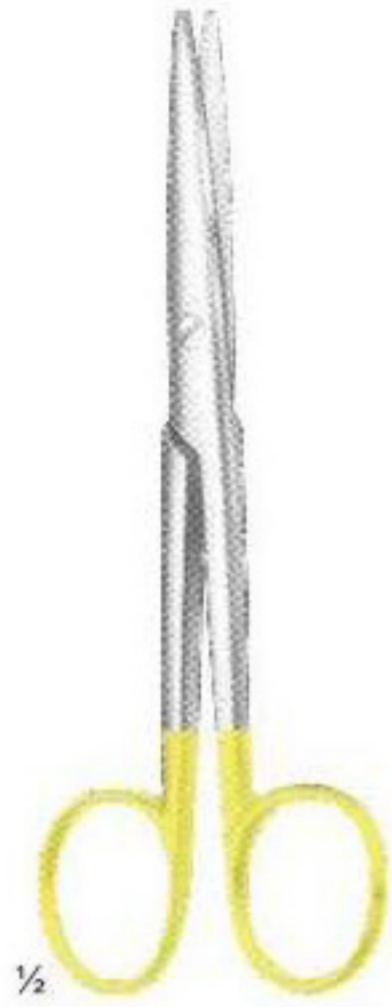

MAYO-STILLE
02-1296 - 02-1297

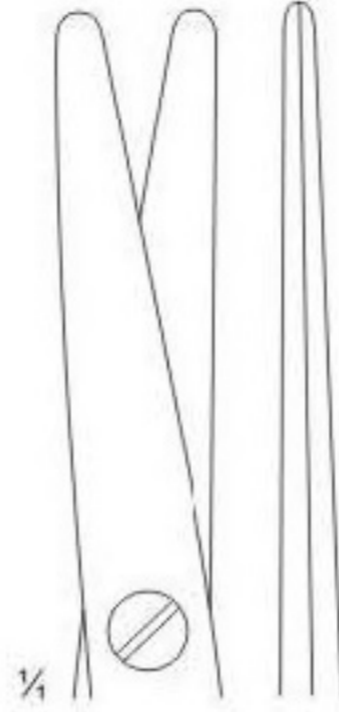

02-1296
14.5 cm

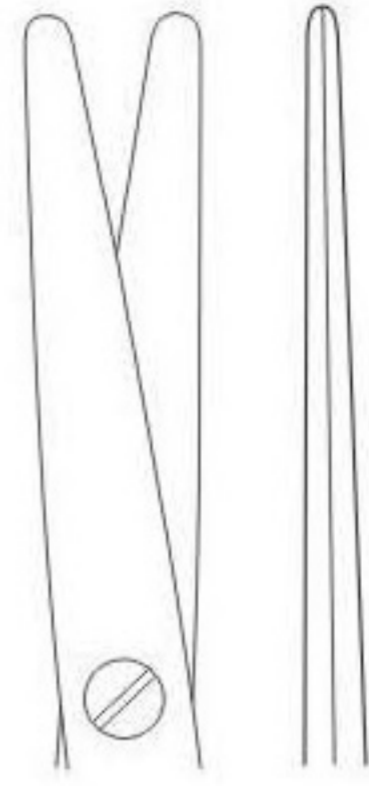

02-1297
17 cm

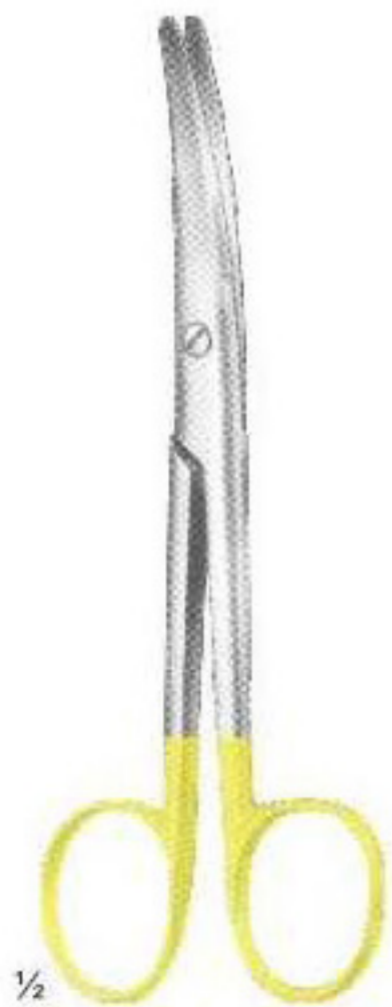

MAYO-STILLE
02-1298 - 02-1299

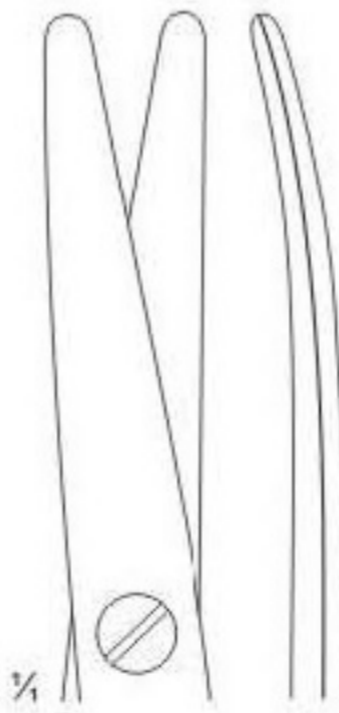

02-1298
14.5 cm

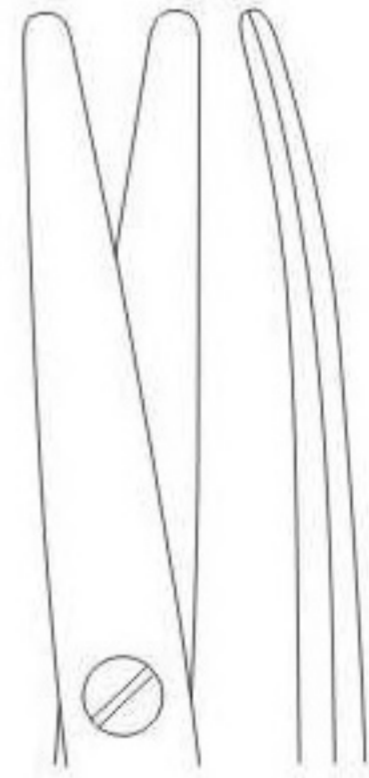

02-1299
17 cm

Dissecting Scissors

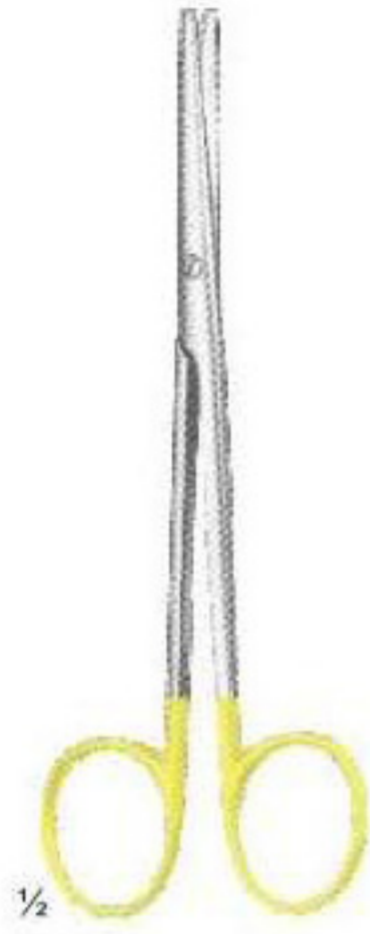

METZENBAUM
02-1300 - 02-1301



02-1300
11.5 cm

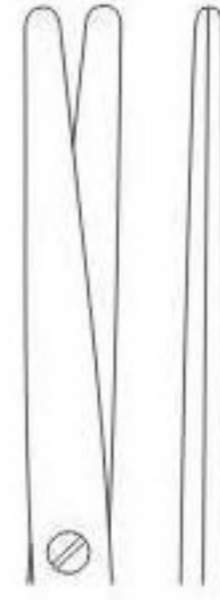

02-1301
14.5 cm

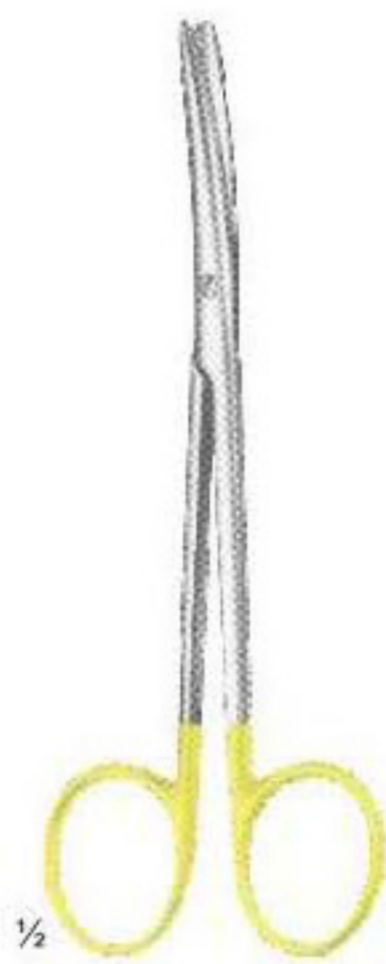

METZENBAUM
02-1302 - 02-1303

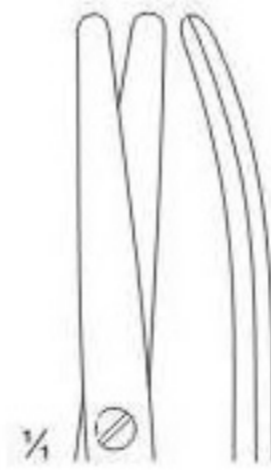

02-1302
11.5 cm



02-1303
14.5 cm

Dissecting Scissors

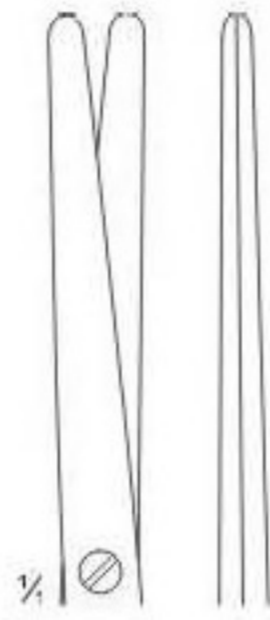

02-1304
18 cm

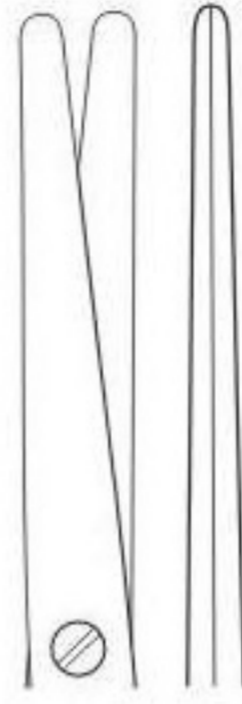

02-1305
20 cm

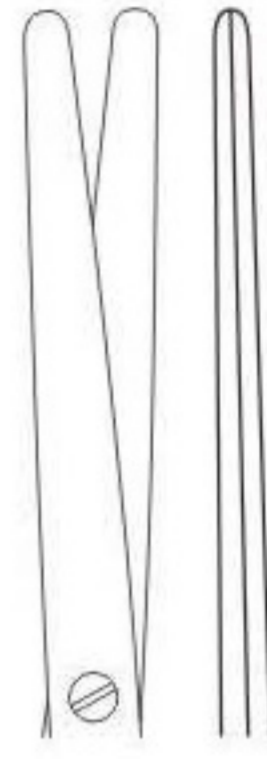

02-1306
23 cm



1/2

METZENBAUM
02-1304 - 02-1309

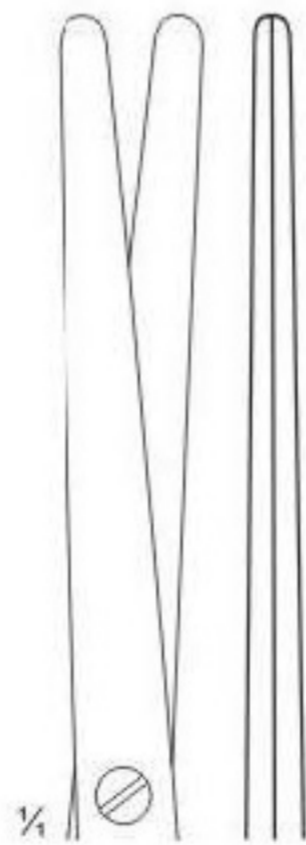

02-1307
26 cm

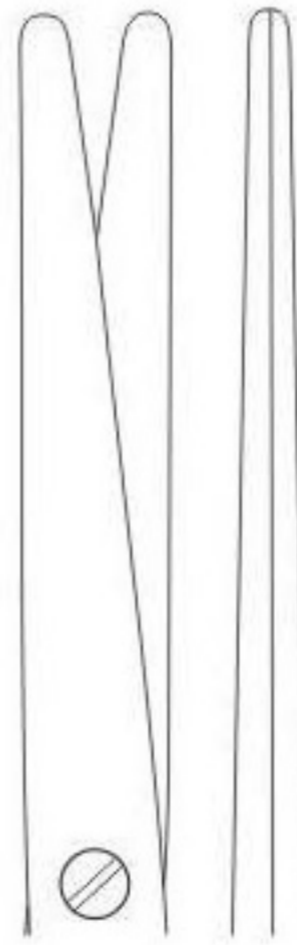

02-1308
28.5 cm

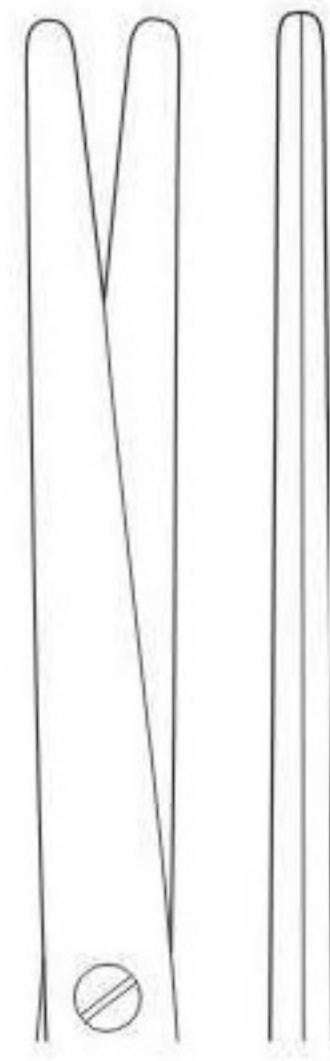

02-1309
31 cm

Dissecting Scissors

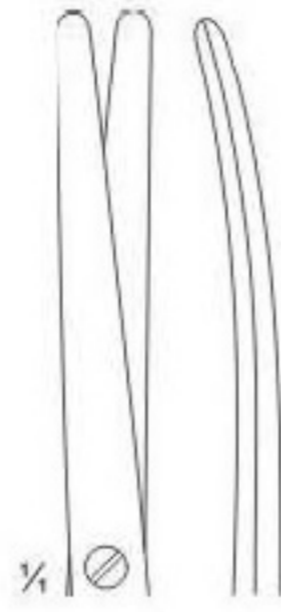

02-1310
18 cm

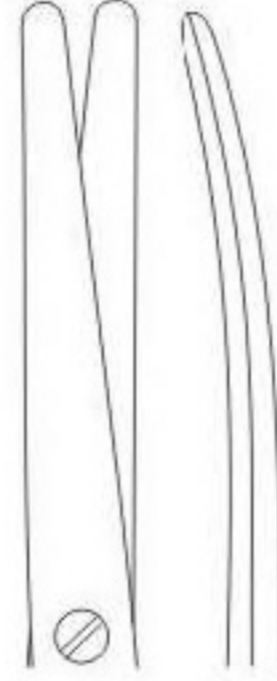

02-1311
20 cm

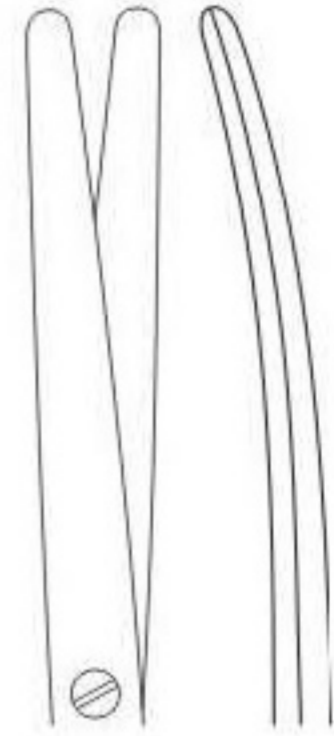

02-1312
23 cm

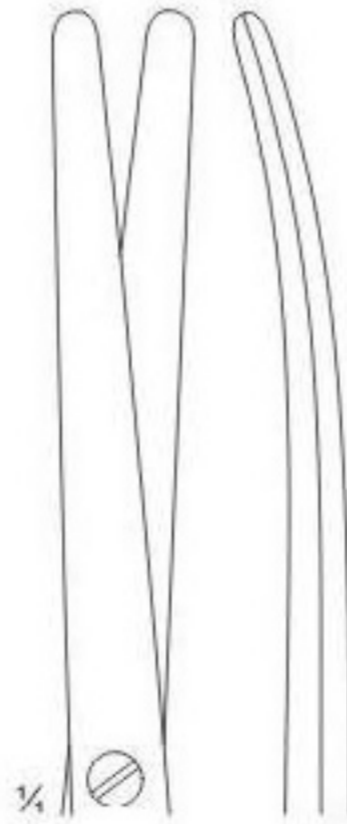

02-1313
26 cm

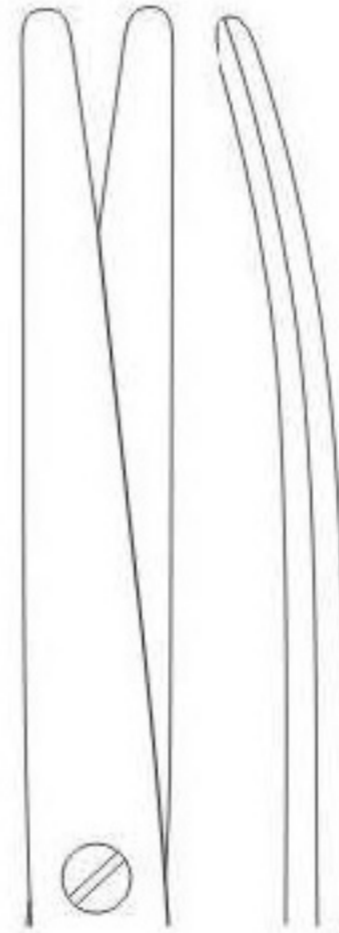

02-1314
28.5 cm

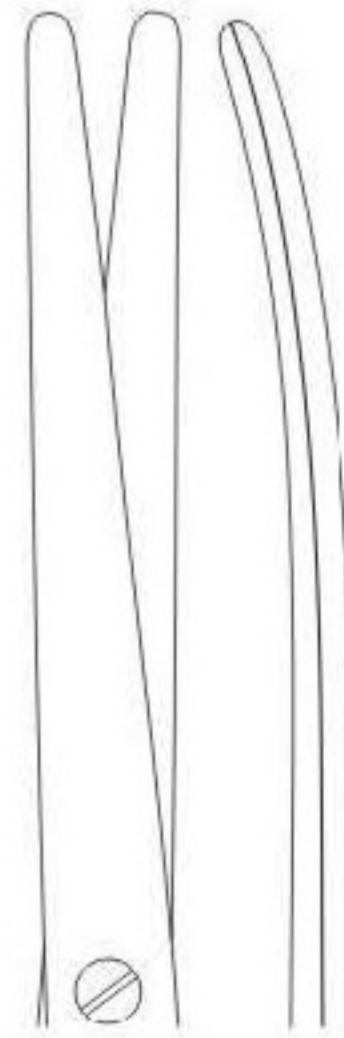

02-1315
31 cm

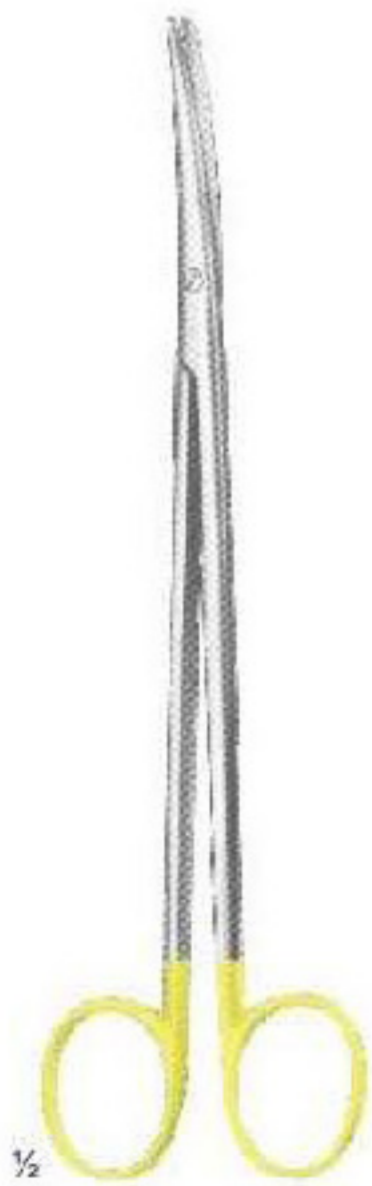

METZENBAUM
02-1310 - 02-1315

Dissecting And Operating Scissors

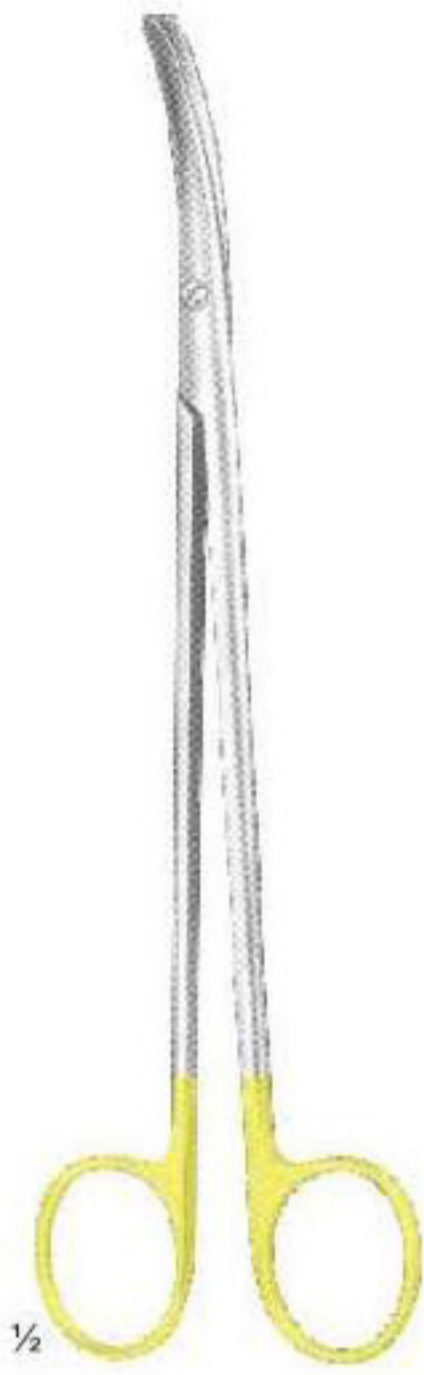

**METZENBAUM-THOREK
02-1316 · 02-1318**

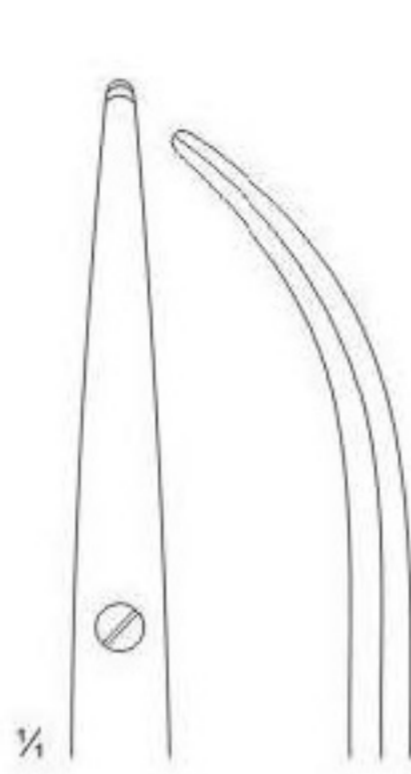

**02-1316
20 cm**

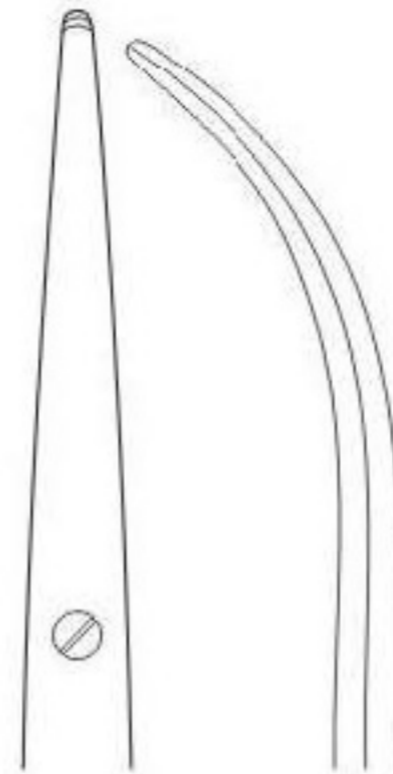

**02-1317
23 cm**

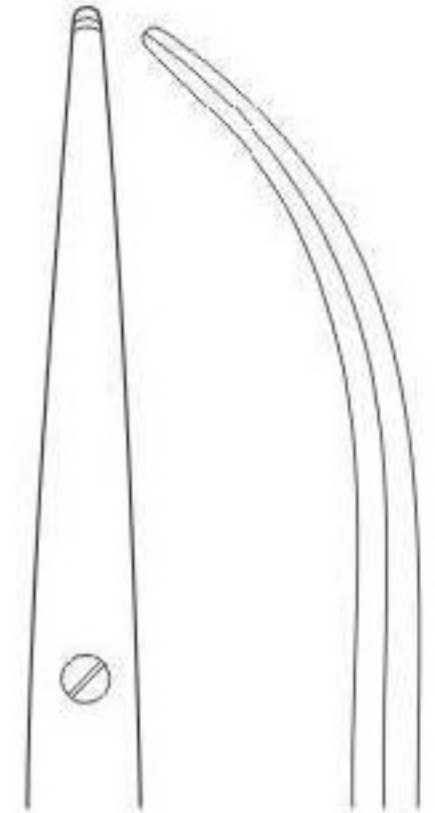

**02-1318
28 cm**



**JOSEPH
02-1319 · 02-1320**

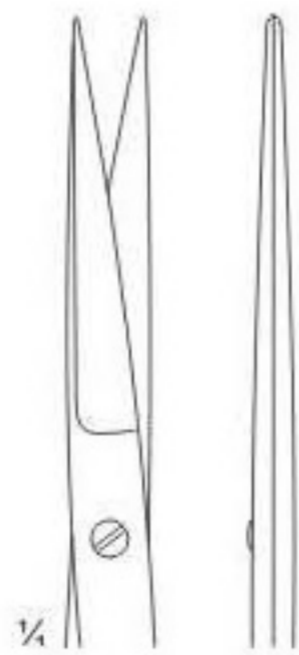

**02-1319
14.5 cm**

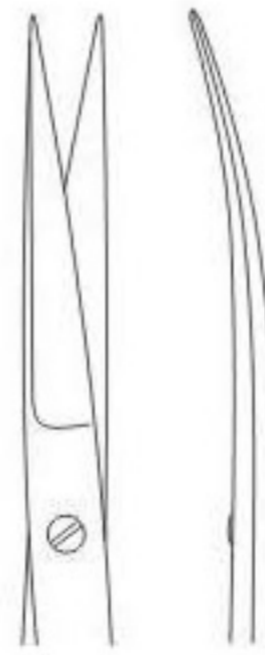

**02-1320
14.5 cm**

Operating And Dissecting Scissors

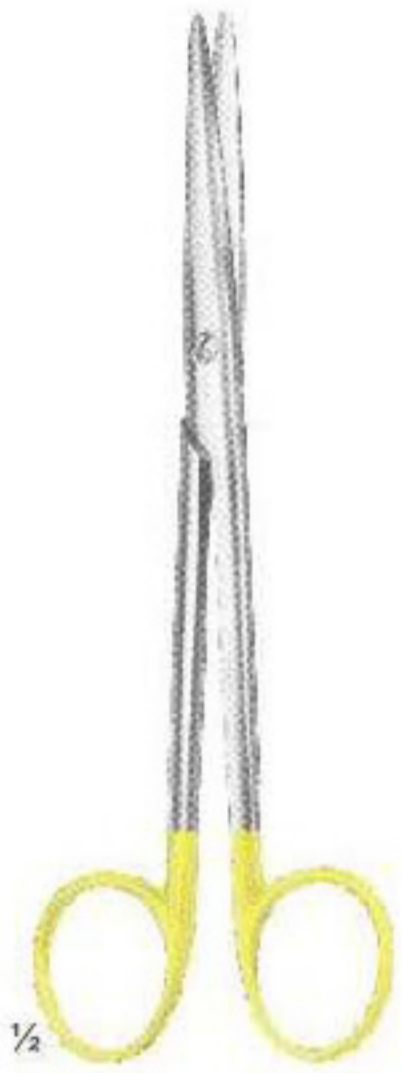

1/2

LEXER
02-1321 - 02-1322

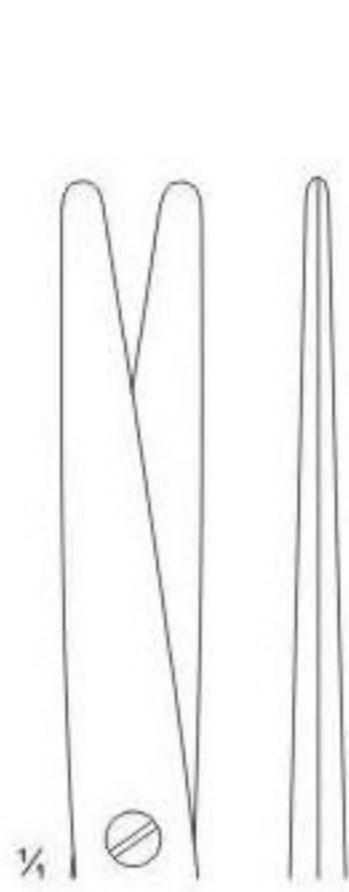

1/4

02-1321
16 cm

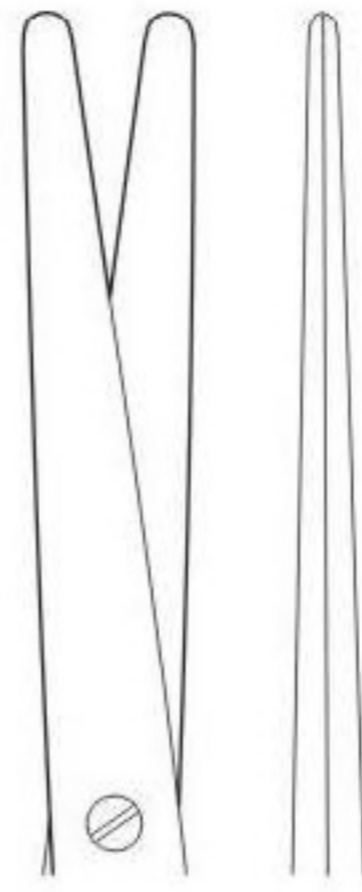

1/4

02-1322
21 cm

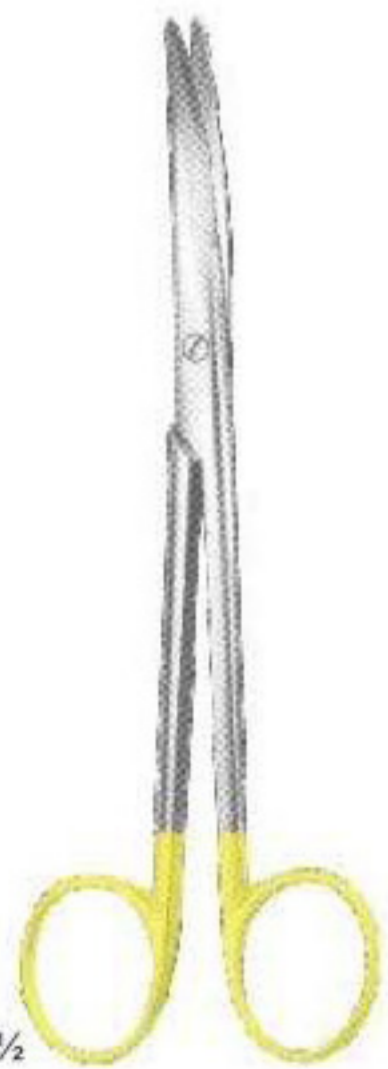

1/2

LEXER
02-1323 - 02-1324

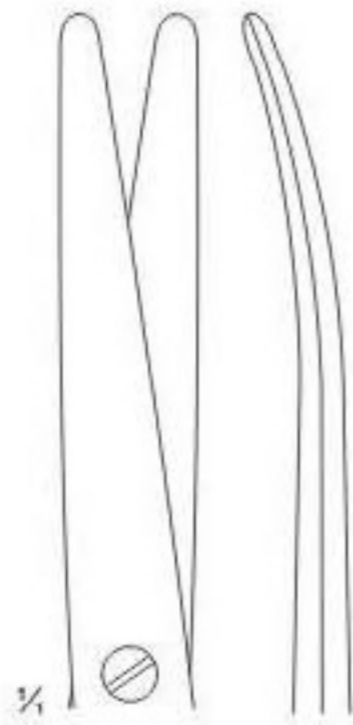

1/4

02-1323
16 cm

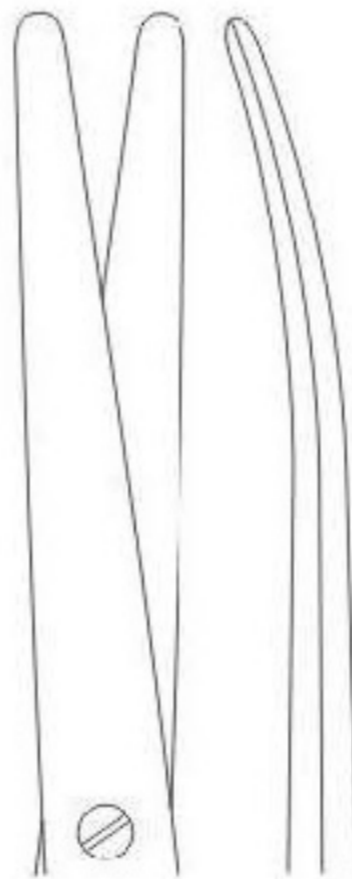

1/4

02-1324
21 cm

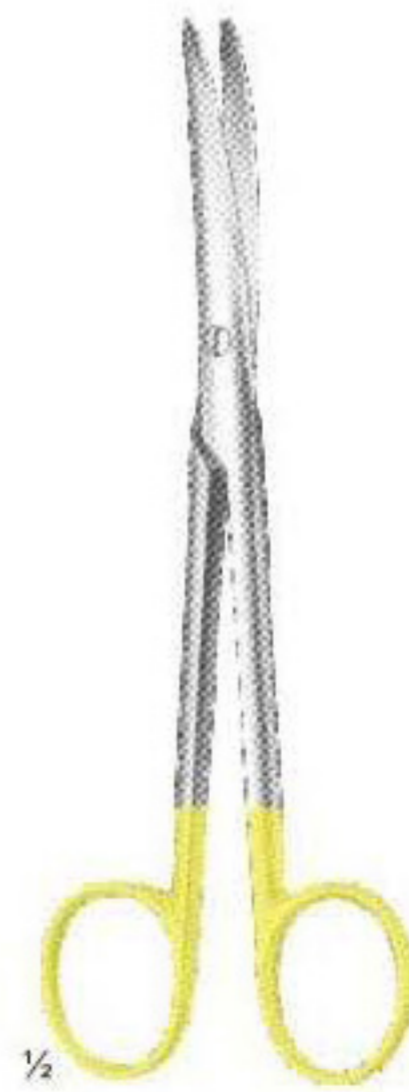

1/2

MAYO-LEXER
02-1325
16 cm

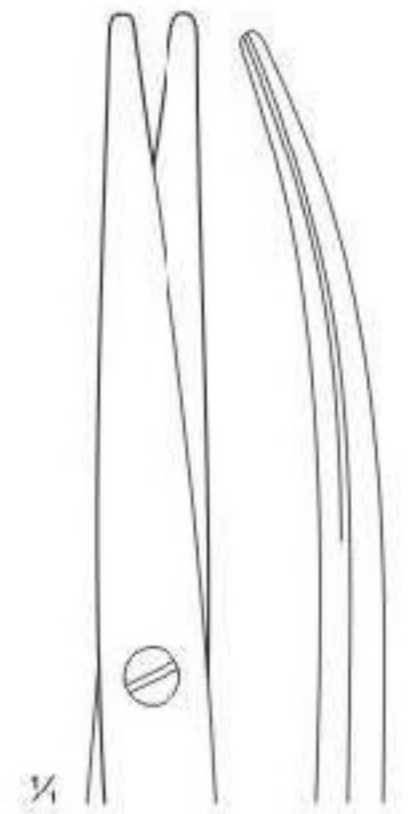

1/4

Delicate Dissecting Scissors



METZENBAUM-FINO
02-1326 - 02-1327
14.5 cm

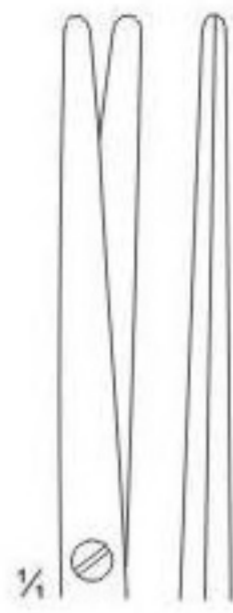

02-1326

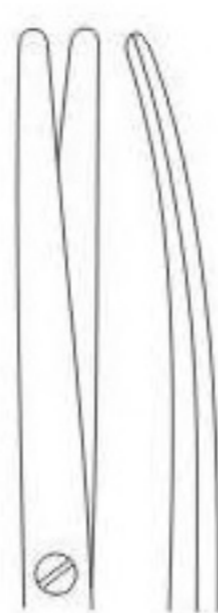

02-1327

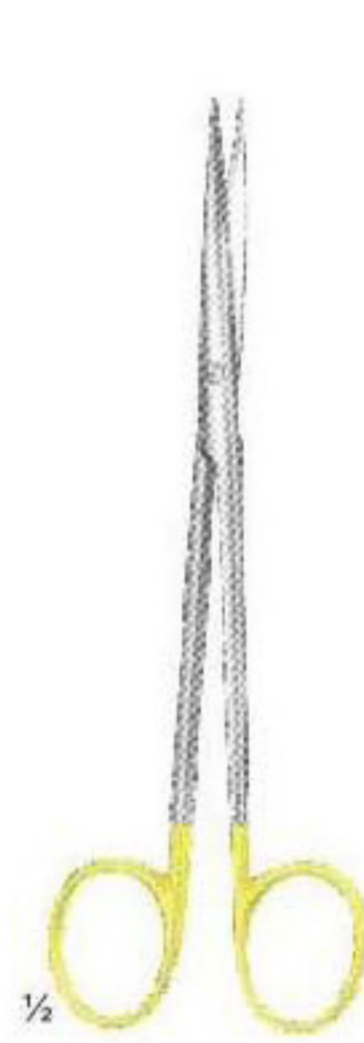

METZENBAUM-FINO
02-1328 - 02-1329
14.5 cm

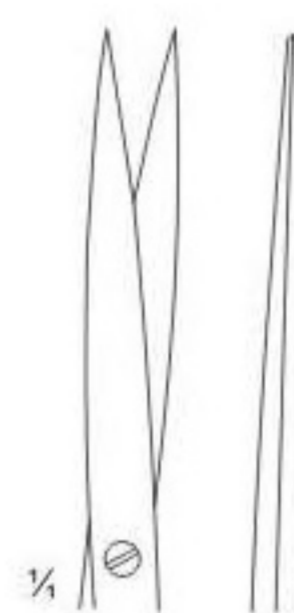

02-1328

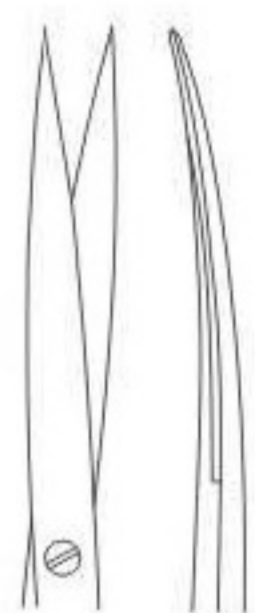

02-1329



METZENBAUM-FINO
02-1330 - 02-1331
18 cm



02-1330

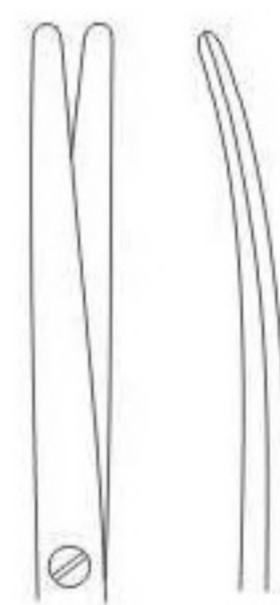

02-1331

Delicate Dissecting Scissors



METZENBAUM-FINO
02-1332 - 02-1335

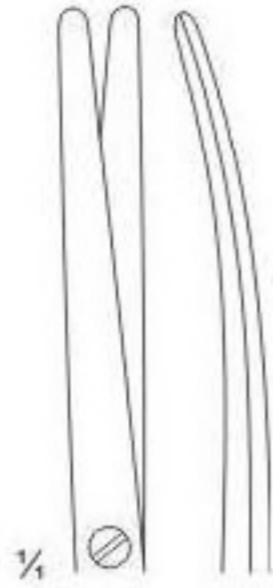

02-1332
20.5 cm

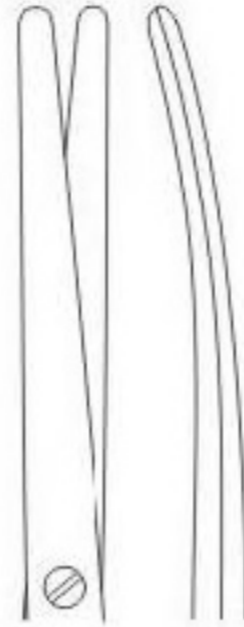

02-1333
23 cm

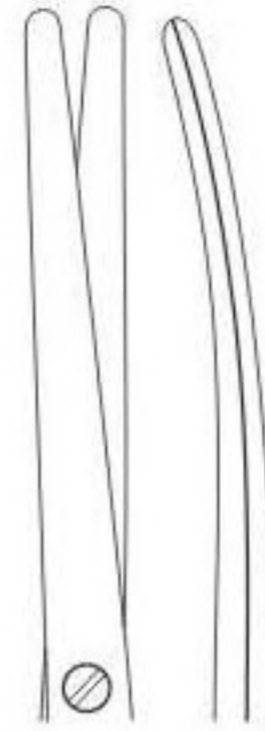

02-1334
26 cm

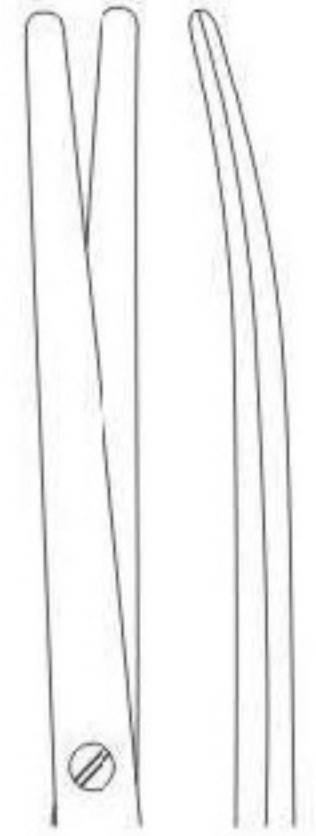

02-1335
28.5 cm



METZENBAUM-FINO
02-1336 - 02-1337

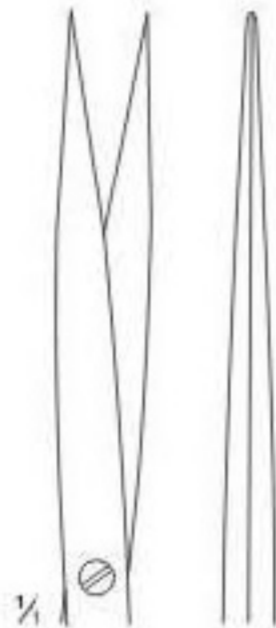

02-1336
18 cm

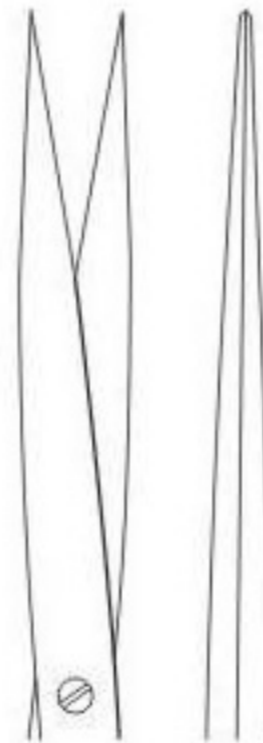

02-1337
20 cm

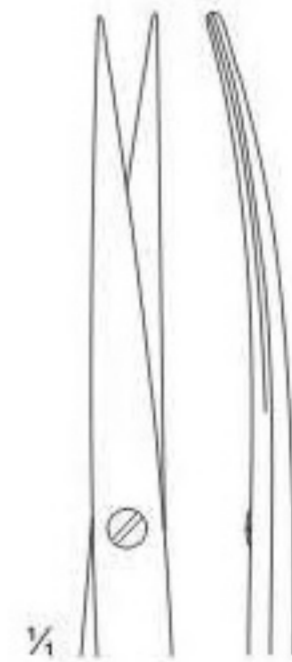

METZENBAUM-LAHEY
02-1338
14.5 cm
slender pattern

Delicate Dissecting Scissors

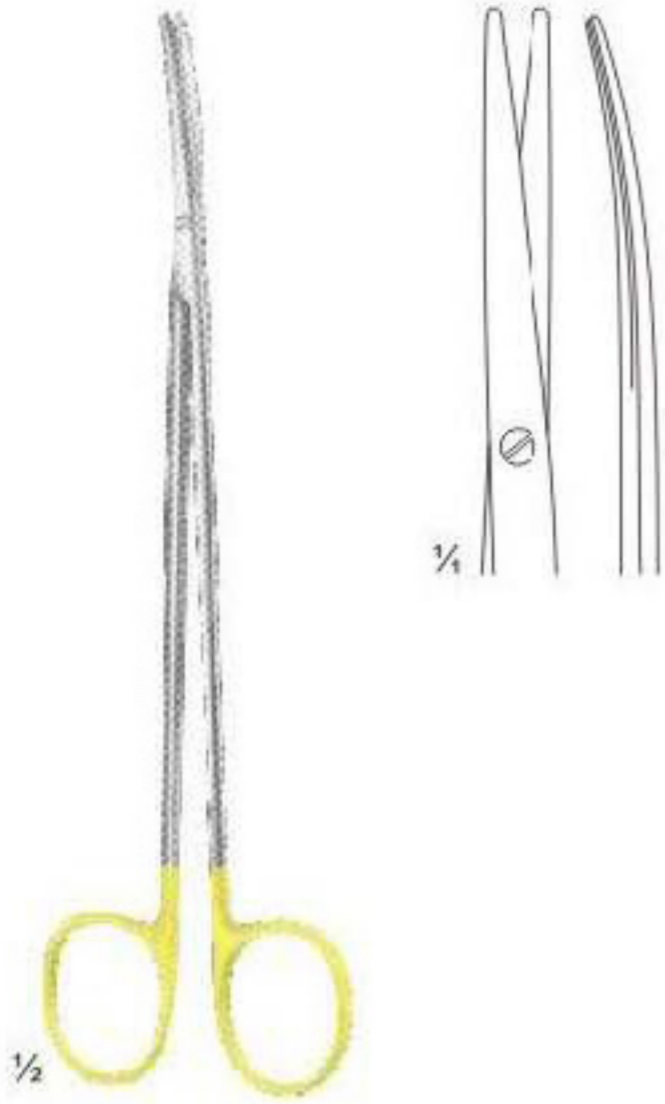

TOENNIS-ADSON
02-1339
17.5 cm
slender pattern

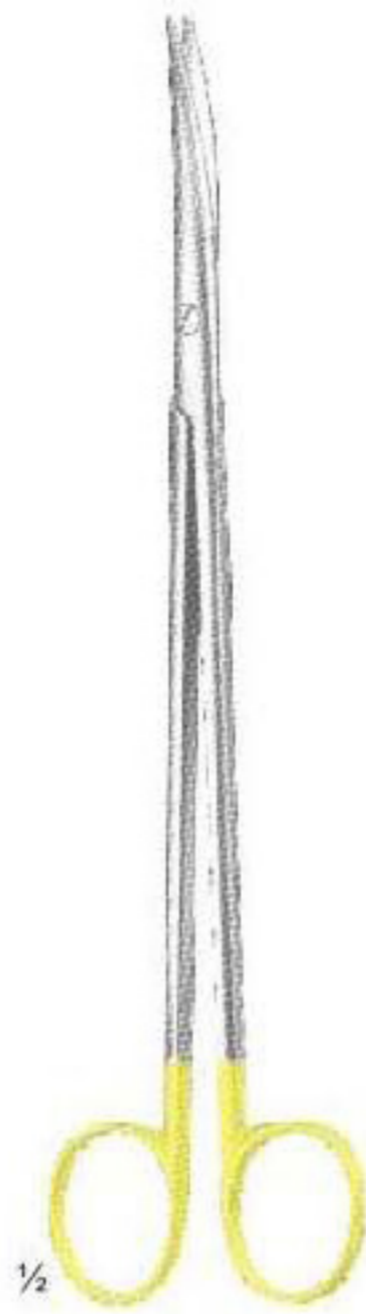

METZENBAUM-FINO
02-1340 - 02-1341
slender pattern

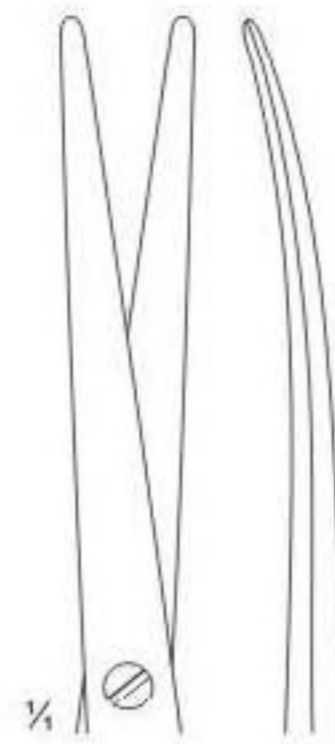

02-1340
20.5 cm

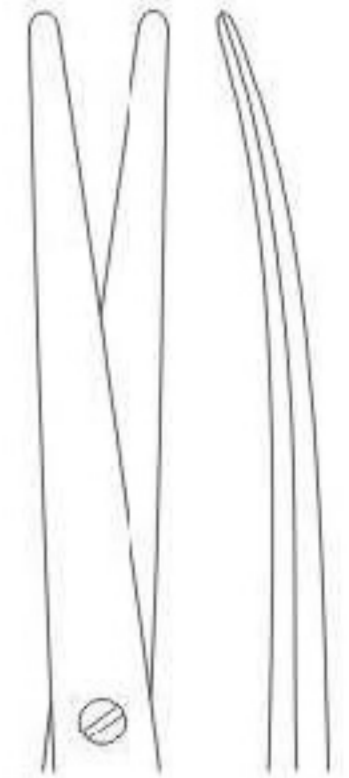

02-1341
23 cm

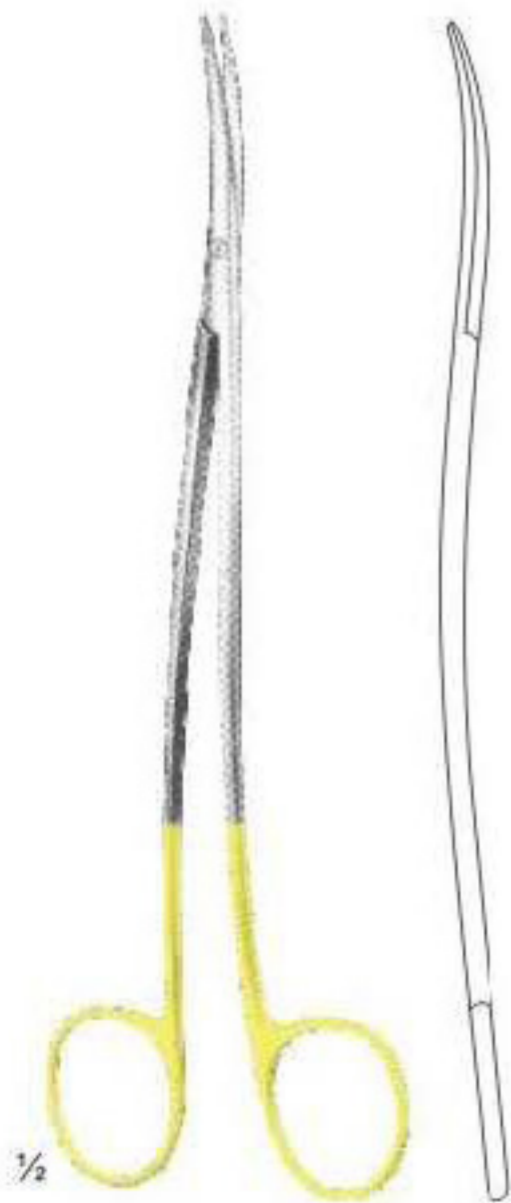

METZENBAUM-FINO
02-1342 - 02-1344
slender pattern

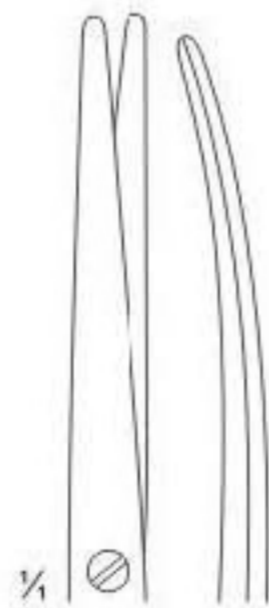

02-1342
18 cm



02-1343
20.5 cm

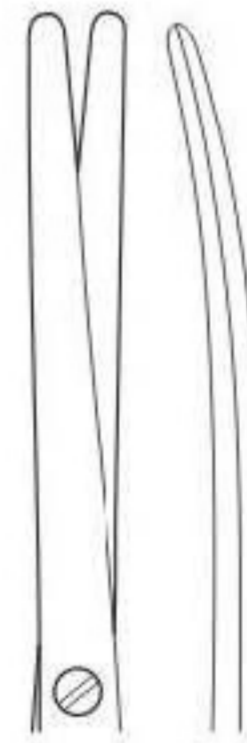

02-1344
23 cm

Face-lift Scissors



GORNEY
02-1345 - 02-1346
one toothed cutting edge

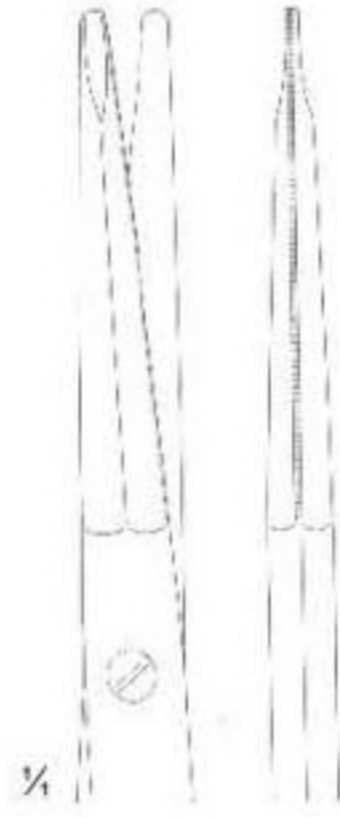

02-1345
20.5 cm



02-1346
23 cm

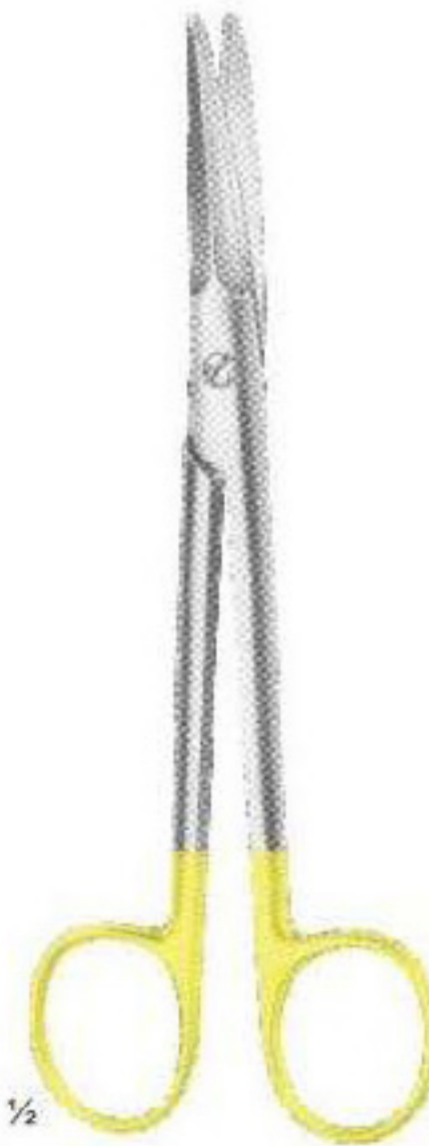

REES
02-1347
17 cm
one toothed cutting edge

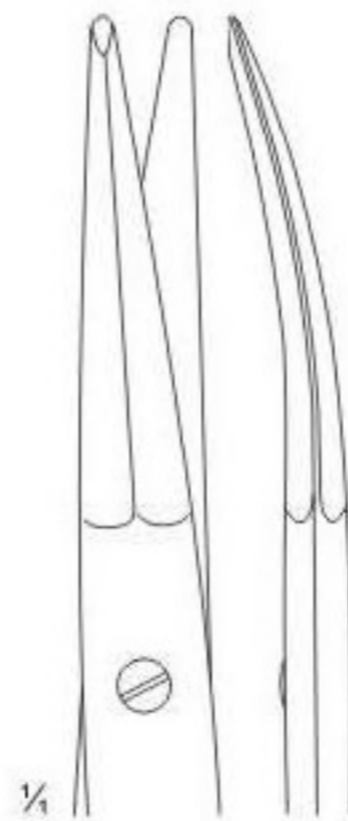

1/4

Aquila Scissors And Uterine Scissors



SIMS-AQUILA
02-1348 - 02-1349
Uterine Scissors
one toothed cutting edge /
one cutting edge knife cut

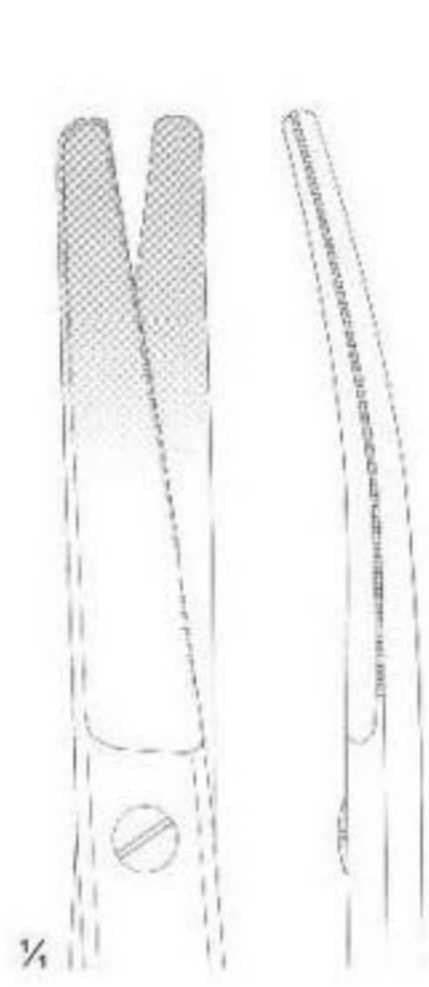

02-1348
20.5 cm

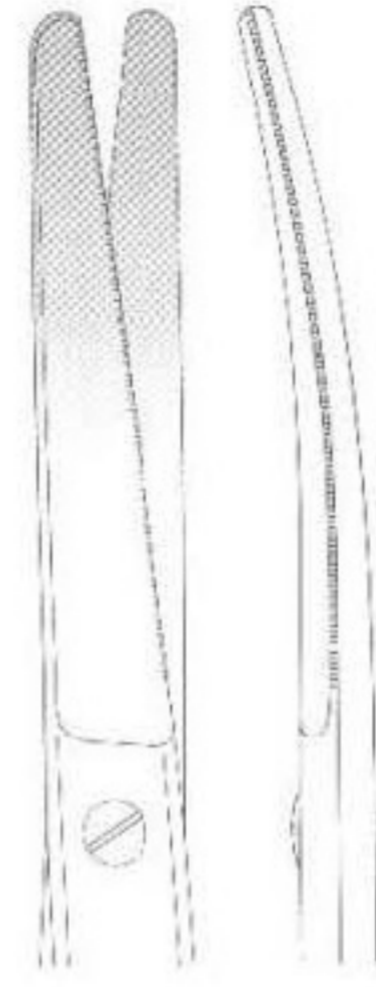

02-1349
23 cm



SIMS
02-1350 - 02-1351
23 cm

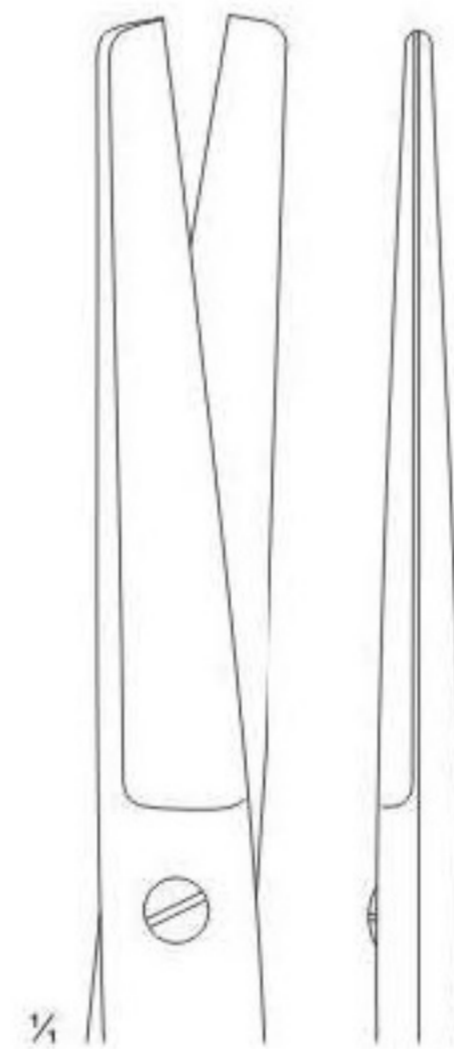

02-1350

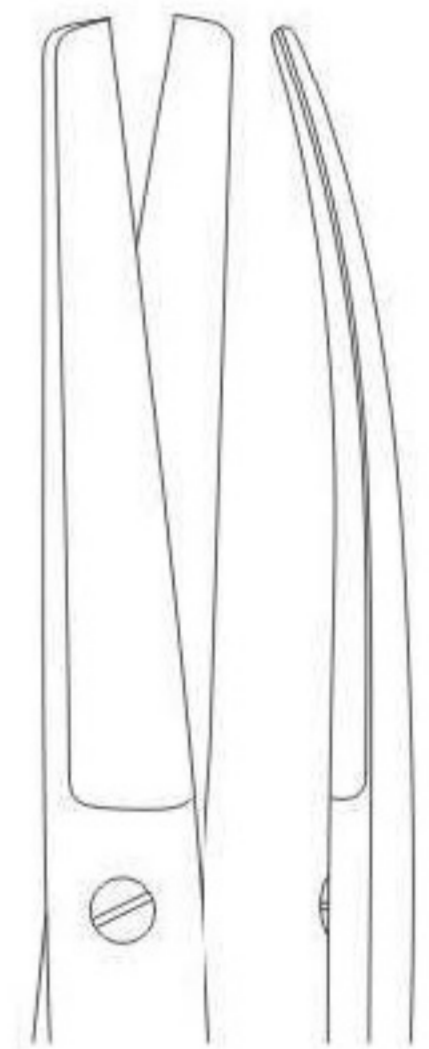

02-1351

Hysterectomy Scissors

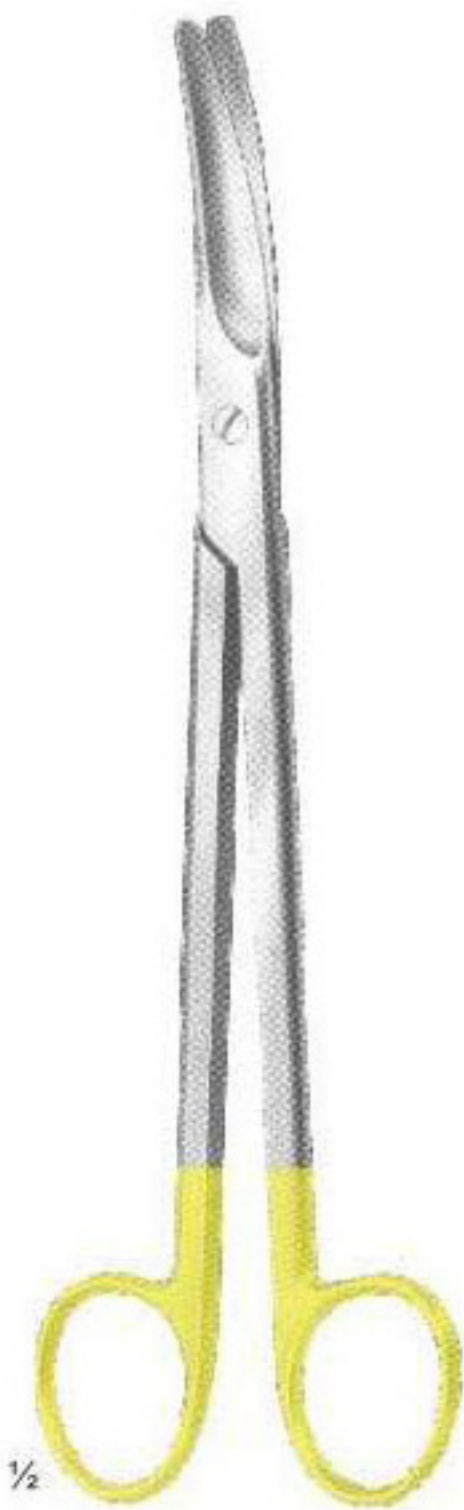

HYSTERECTOMY
02-1352 - 02-1353
heavy pattern

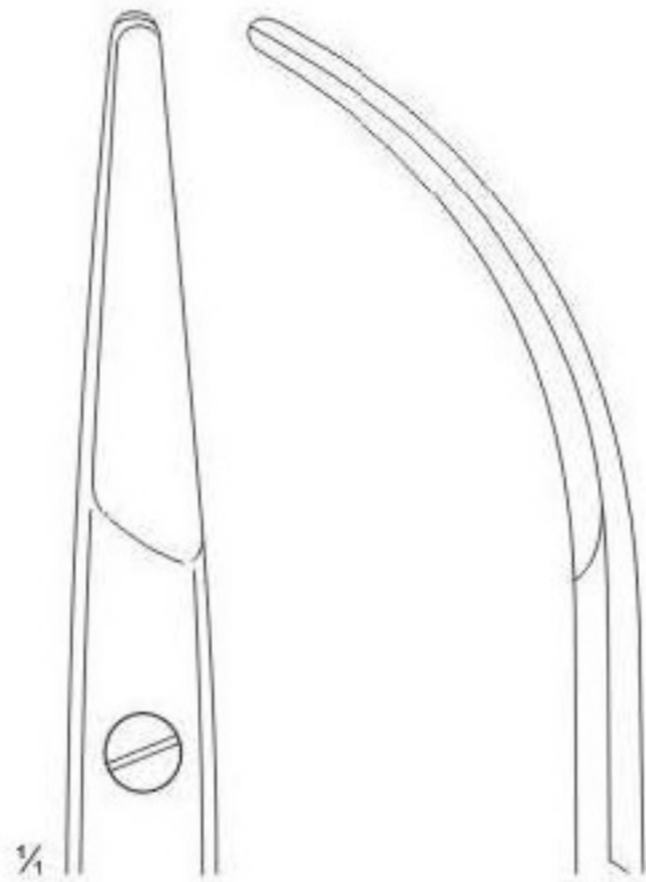

02-1352
22 cm

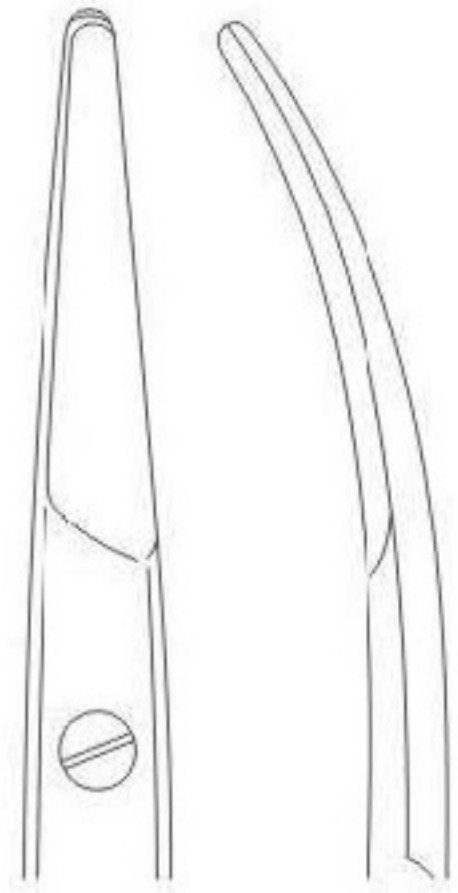

02-1353
23 cm

Ligature And Iris Scissors



GOLDMANN-FOX
02-1354 - 02-1355
13 cm
one toothed cutting edge



02-1354

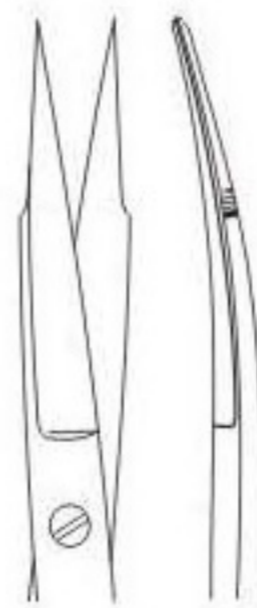

02-1355

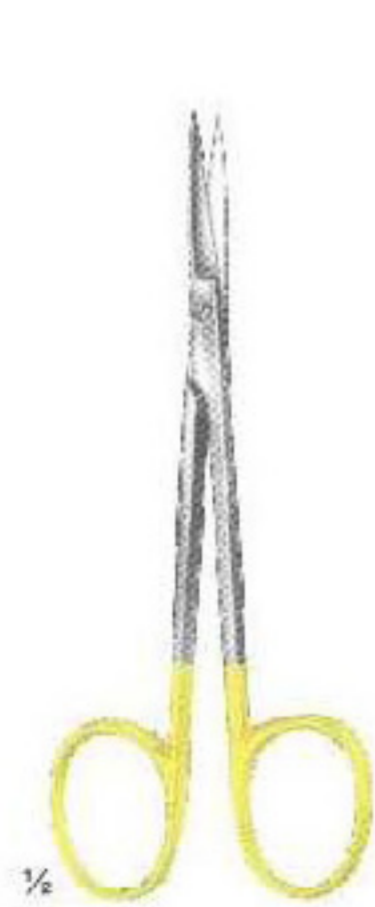

02-1356
11.5 cm



IRIS
02-1357
11.5 cm



Angled Scissors

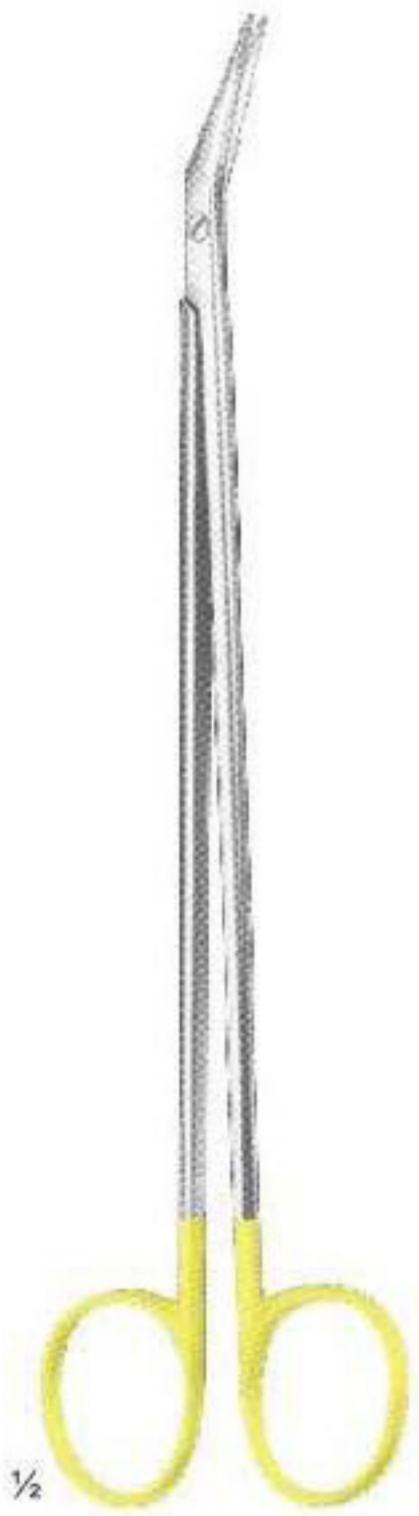

DE BAKEY
02-1358 - 02-1363

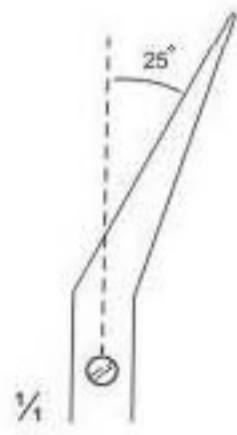

02-1358
19 cm

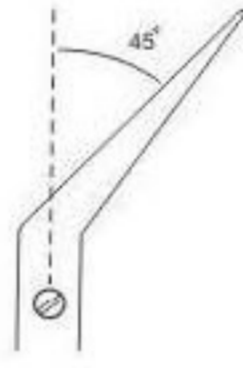

02-1359
18.5 cm

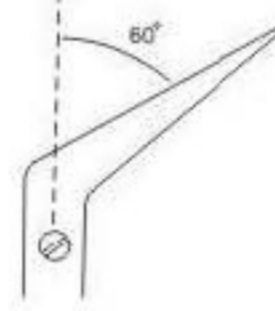

02-1360
18 cm

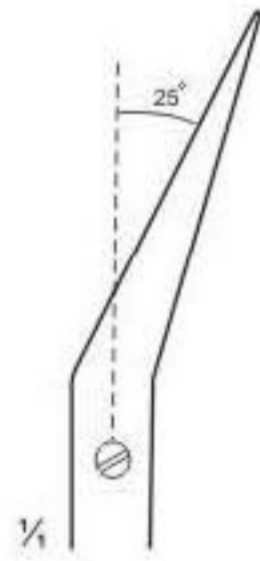

02-1361
23 cm

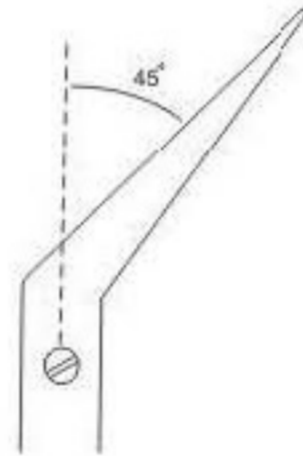

02-1362
23 cm

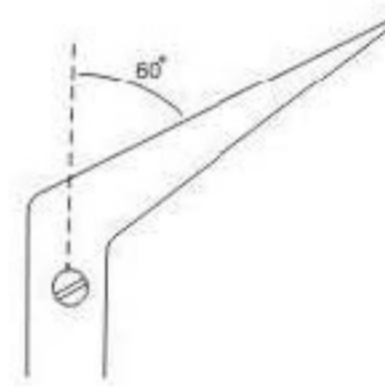

02-1363
22 cm

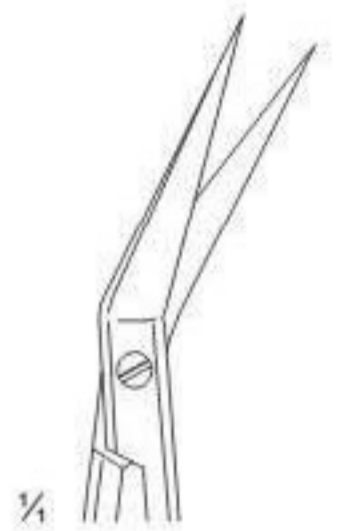

02-1364
11 cm

Dissecting, Operating, Tonsil And Wire Cutting Scissors

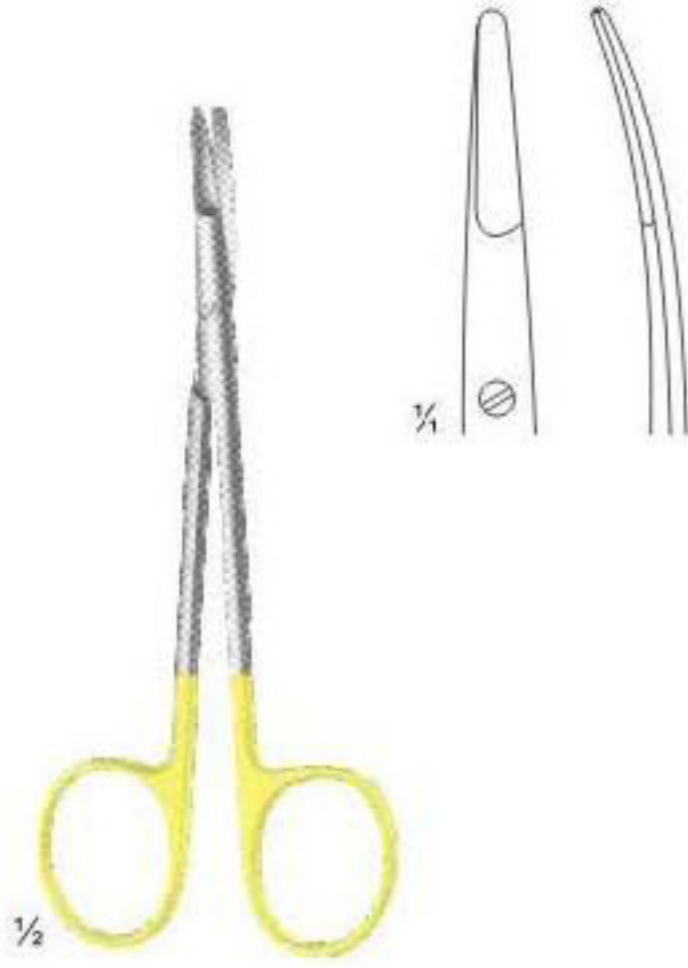

RAGNELL
02-1365
12.5 cm

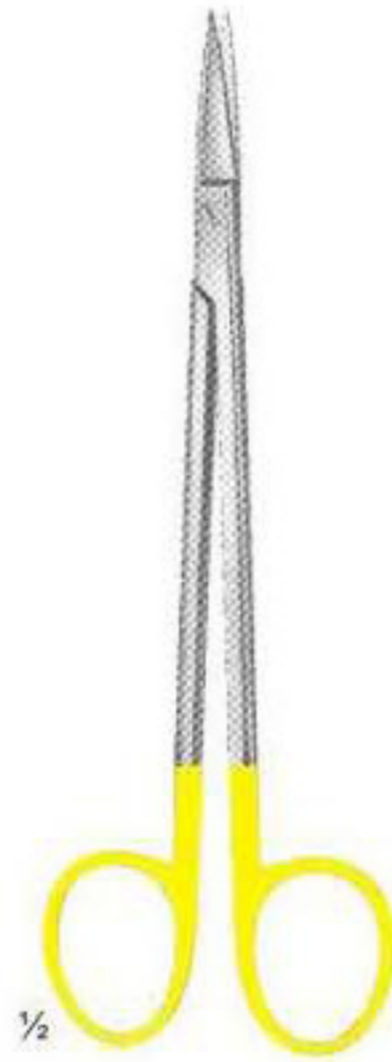

KELLY
02-1366 - 02-1367

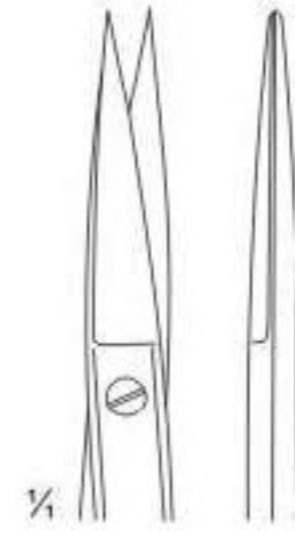

02-1366
16 cm

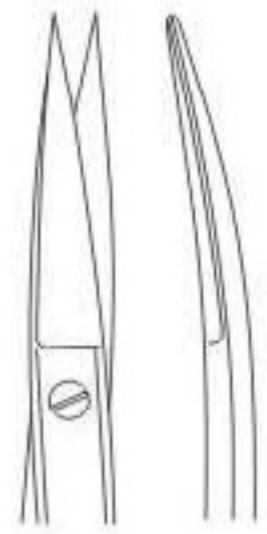

02-1367
16 cm

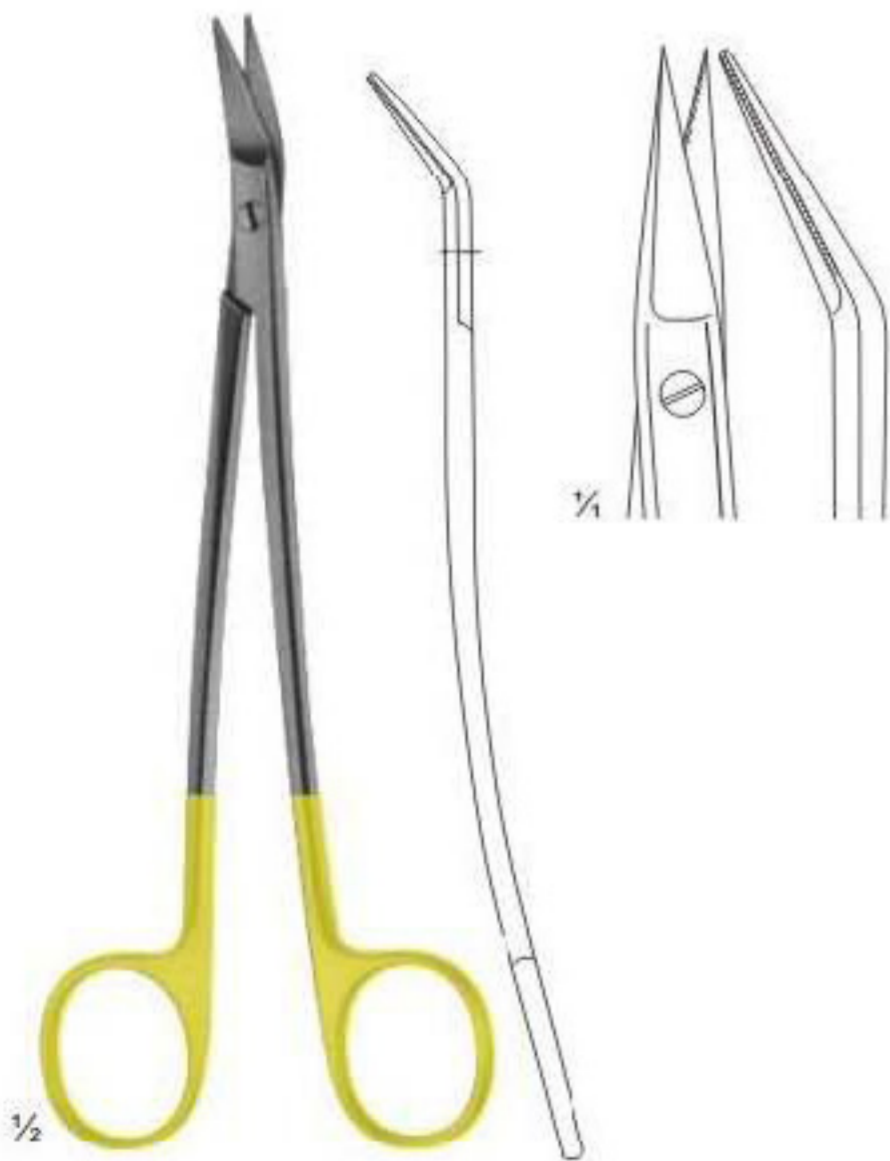

DEAN
02-1368
17.5 cm
one toothed cutting edge

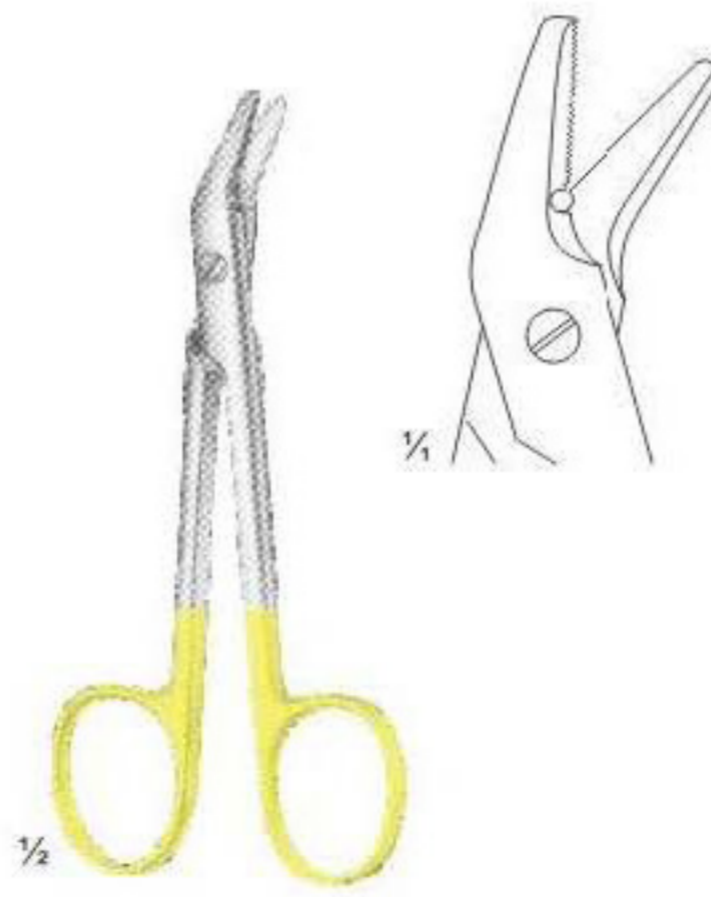

UNIVERSAL
02-1369
12.5 cm
one toothed cutting edge

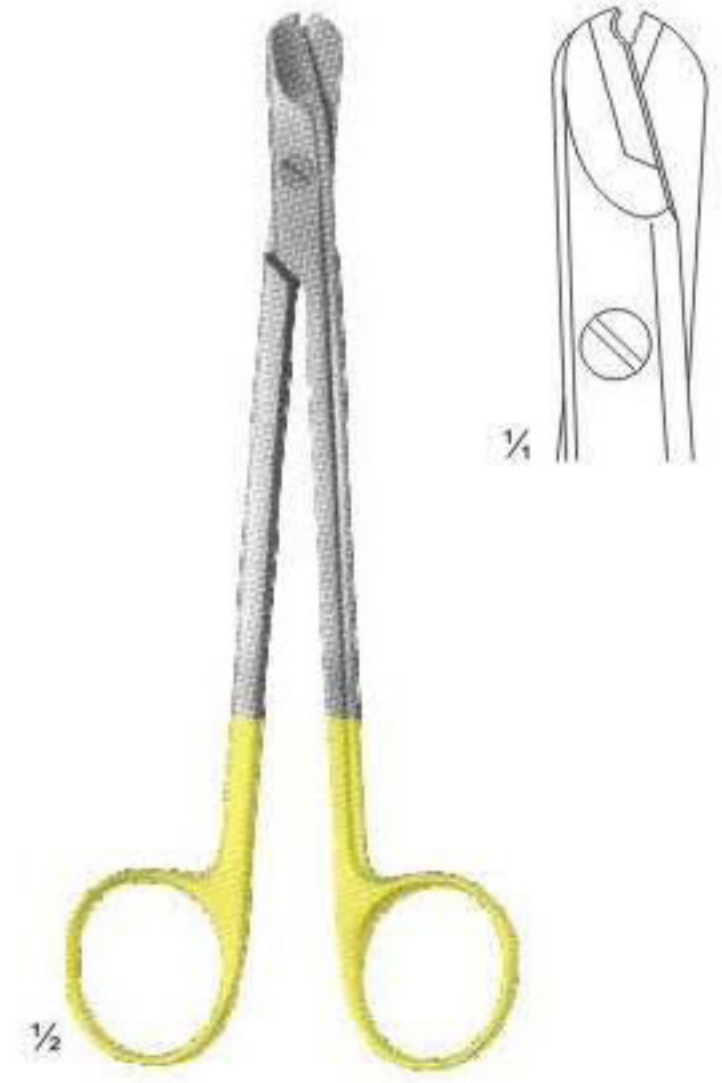

MARTIN
02-1370
16 cm
Wire cutting scissors

Delicate, Nasal And Tonsil Gum Scissors



FOMON
02-1371
Blades Serrated
14.5 cm



COTTLE
02-1372
16.5 cm

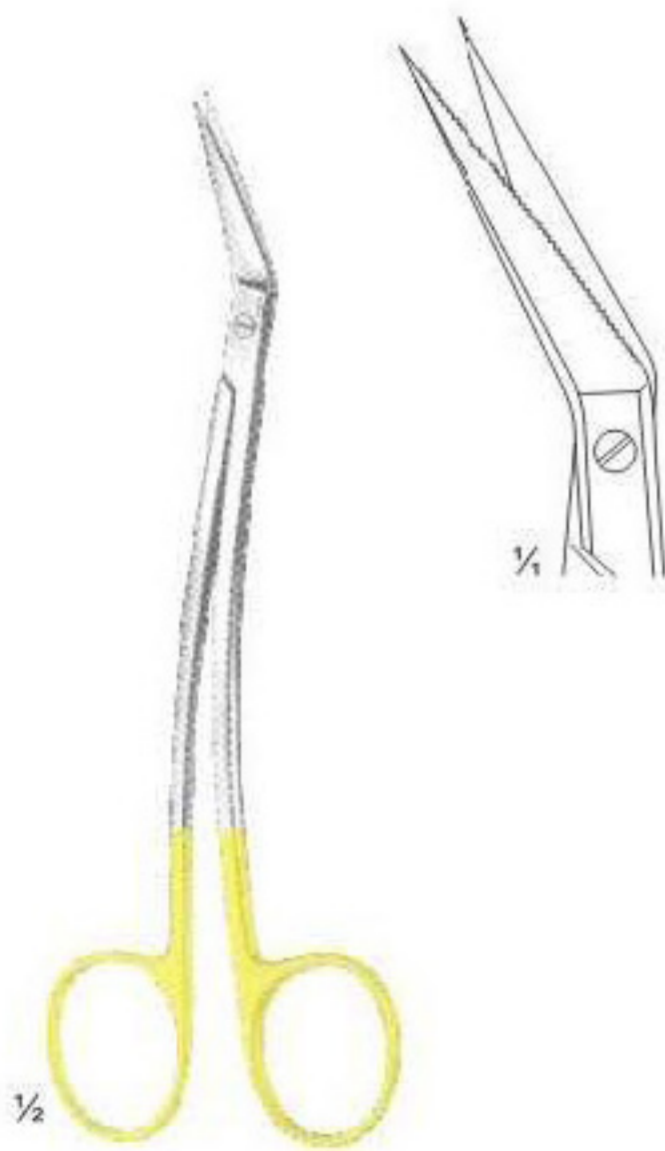

LOCKLIN
02-1373
16 cm
one toothed cutting edge

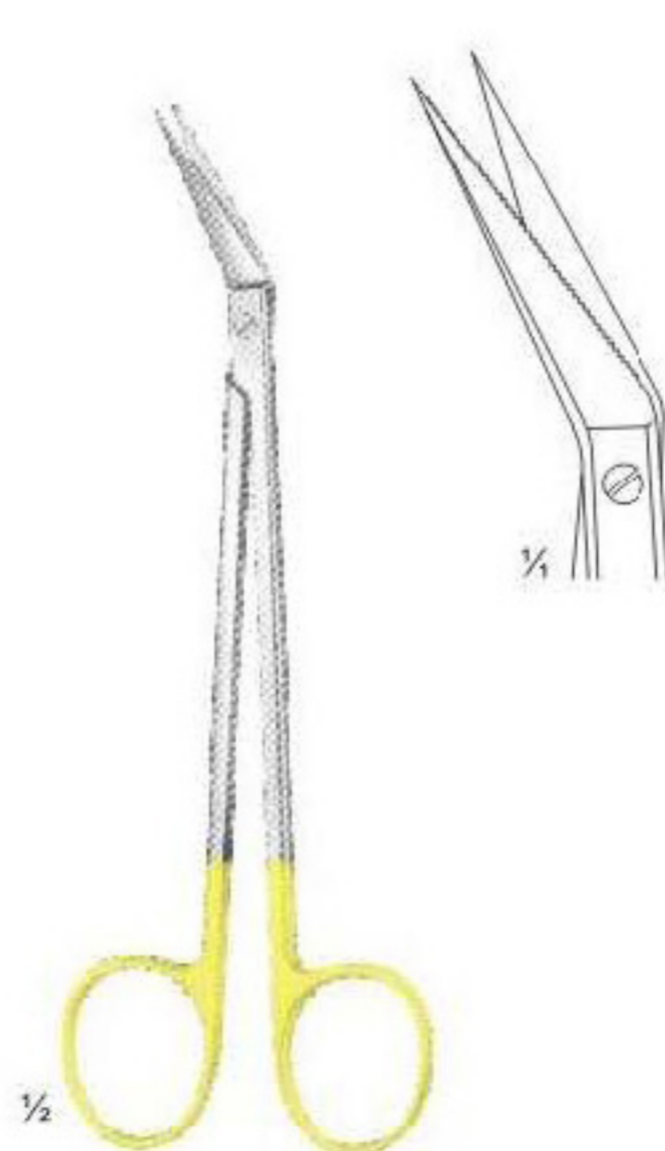

LOCKLIN
02-1374
16 cm
one toothed cutting edge

Page 58-71



- Dissecting & Delicate Tissue Forceps
- Delicate Dissecting Forceps
- Forceps, Bayonet - Shaped
- Delicate Tissue Forceps
- Tissue Forceps
- Lung Dissecting Forceps
- Forceps For Grasping Tissue, Tumors
- Ligature Forceps, Micro Forceps (light patterns)
- Splinter & Cilia Forceps
- Forceps With Tungsten Carbide Inserts



Delicate Tissue Forceps

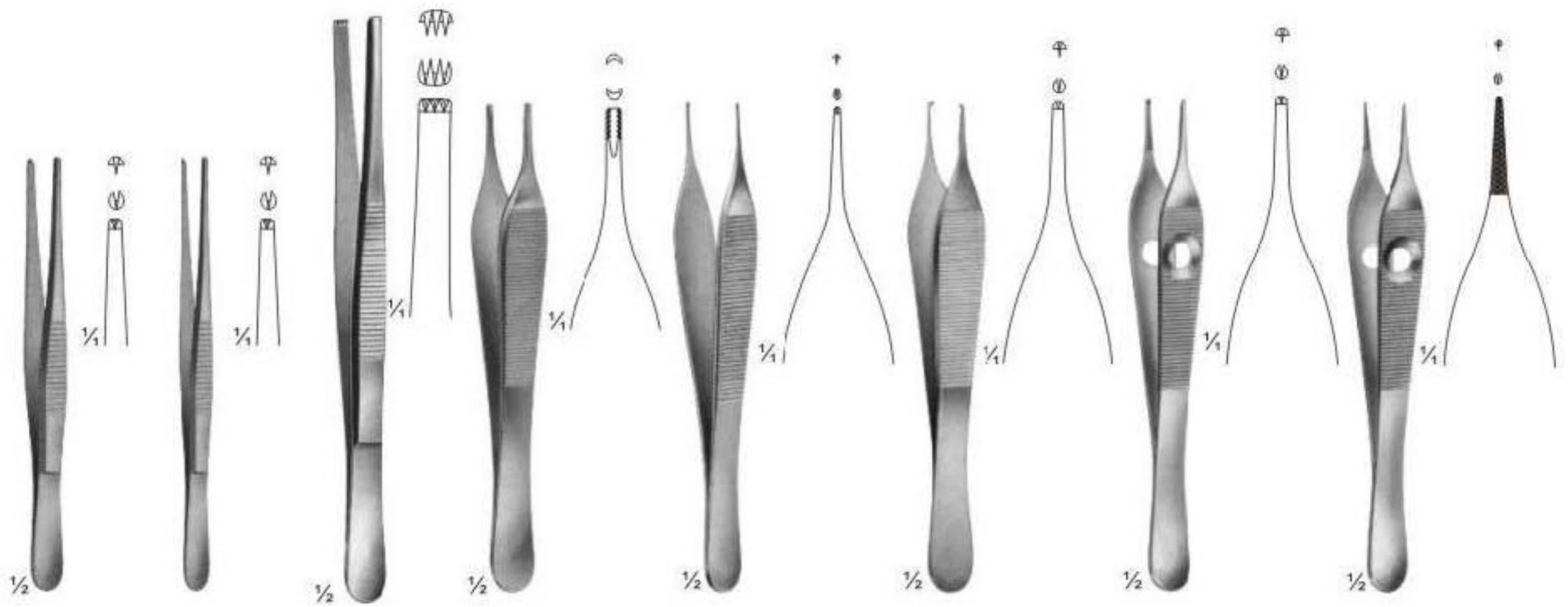

STANDARD
03-1001
 10.5 cm
03-1002
 11.5 cm
03-1003
 13 cm
03-1004
 14.5 cm
03-1005
 16 cm
03-1006
 18 cm
03-1007
 20 cm
03-1008
 25 cm
03-1009
 30 cm

NARROW
03-1010
 11.5 cm
03-1011
 13 cm
03-1012
 14.5 cm
03-1013
 18 cm
03-1014
 25 cm

3x4 teeth
03-1015
 14.5 cm
03-1016
 16 cm
03-1017
 20 cm

ADSON - BROWN
 Non-traumatic
03-1018
 12 cm

MICRO-ADSON
03-1019
 12 cm

ADSON
03-1020
 12 cm

ADSON
03-1021
 12 cm
03-1022
 15 cm

ADSON
03-1023
 12 cm

Forceps, Bayonet - Shaped



LUCAE
03-1024
14 cm

JANSEN
03-1025
16 cm

TAYLOR
03-1026
18.5 cm

GRUENWALD
03-1027
20 cm

COTTLE
03-1028
Forceps with
jaws toothed
and serrated
14 cm



TROELTSCH
03-1029 - 03-1030
03-1029
10 cm
03-1030
11.5 cm

WILDE
03-1031
11.5 cm

TROELTSCH
03-1032
cross action
12 cm

TROELTSCH
03-1033
14 cm

Ligature Forceps, Micro Forceps (light Patterns)



MULLER
03-1034
 11 cm 0.15 mm
03-1035
 11 cm 0.20 mm
03-1036
 11 cm 0.30 mm
03-1037
 11 cm 0.50 mm
03-1038

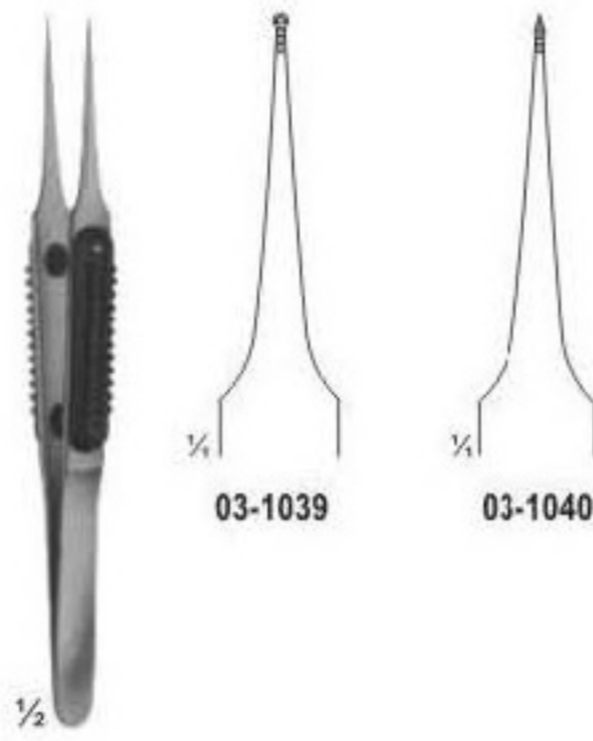

MULLER
03-1039
 11 cm
03-1040
 11 cm



YASARGIL
03-1041
 18.5 cm



YASARGIL
03-1042
 18 cm
03-1043
 20 cm
03-1044
 22 cm
03-1045
 24 cm



YASARGIL
03-1046
 20 cm 0.6 mm
03-1047
 20 cm 0.9 mm



YASARGIL
03-1048
 22 cm 0.6 mm
03-1049
 22 cm 0.9 mm

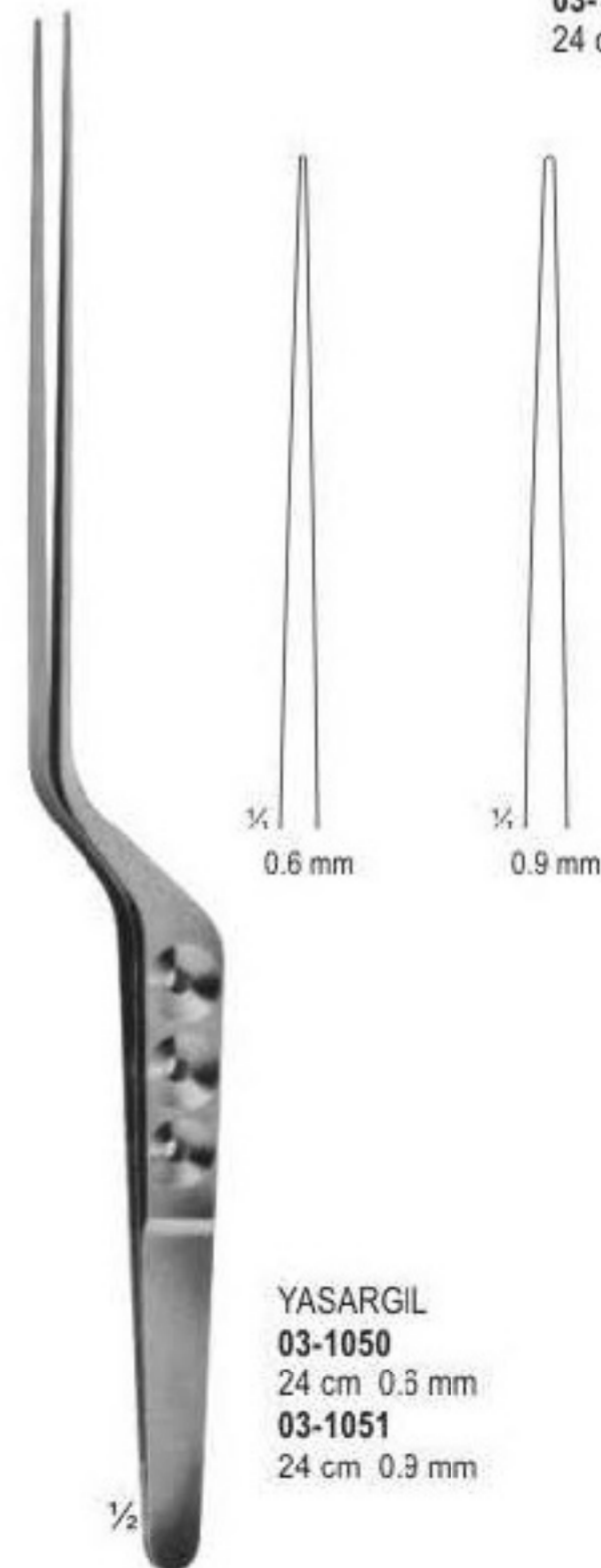

YASARGIL
03-1050
 24 cm 0.6 mm
03-1051
 24 cm 0.9 mm

Delicate Dissecting Forceps



Dissecting & Delicate Tissue Forceps

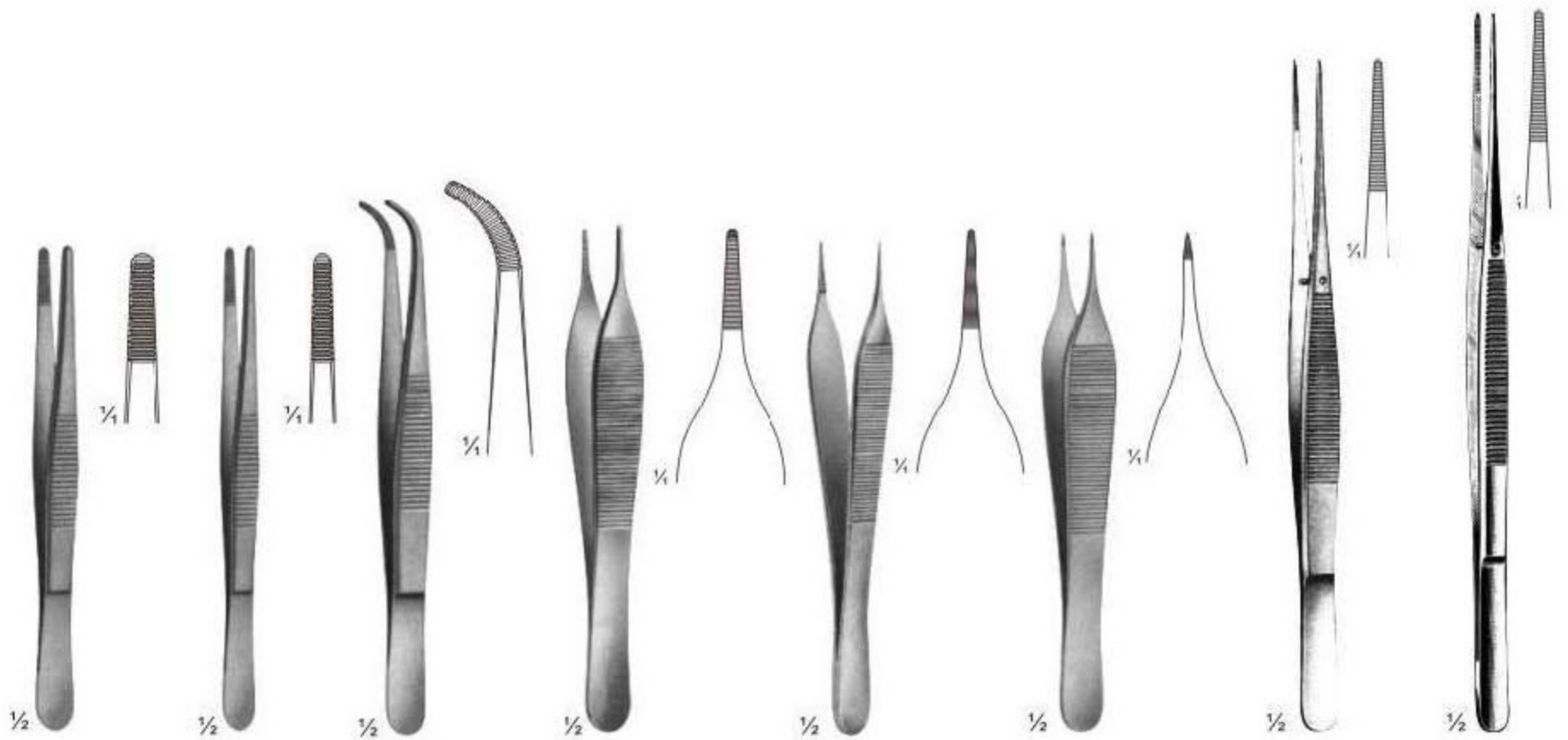

STANDARD
03-1066 - 03-1075
03-1066
11.5 cm
03-1067
12 cm
03-1068
13 cm
03-1069
14.5 cm
03-1070
15 cm
03-1071
16 cm
03-1072
18 cm
03-1073
20 cm
03-1074
25 cm
03-1075
30 cm

NARROW
03-1076 - 03-1080
03-1076
11.5 cm
03-1077
13 cm
03-1078
14.5 cm
03-1079
18 cm
03-1080
25 cm

NARROW
03-1081 - 03-1082
03-1081
13 cm
03-1082
14.5 cm

ADSON
03-1083 - 03-1084
03-1083
12 cm
03-1084
15 cm

MICRO-ADSON
03-1085 - 03-1086
03-1085
12 cm
03-1086
15 cm

THOREK
Corneal Forceps
03-1087
12 cm

POTTS-SMITH
03-1088 - 03-1090
03-1088
18 cm
03-1089
21 cm
03-1090
25 cm

TAYLOR
03-1091 - 03-1092
03-1091
17 cm
03-1092
18 cm

Tissue Forceps

<p>1/2</p>	<p>1/2</p>	<p>1/2</p>	<p>1/2</p>	<p>1/2</p>	<p>1/2</p>
<p>GRAEFE 03-1093 11 cm 03-1094 11.5 cm 03-1095 13 cm 03-1096 14.5 cm 03-1097 16 cm</p>	<p>MC INDOE 03-1098 15 cm</p>	<p>SEMKEN 03-1099 12.5 cm 03-1100 12.5 cm 03-1101 15 cm</p>	<p>GERALD 03-1102 17.5 cm 03-1103 17.5 cm 03-1104 23 cm</p>	<p>WAUGH 03-1105 18 cm 03-1106 20 cm 03-1107 25 cm 03-1108 30.5 cm</p>	<p>BROPHY 03-1109 20 cm</p>
<p>1/2</p>	<p>1/2</p>	<p>1/2</p>	<p>1/2</p>	<p>1/2</p>	<p>1/2</p>
<p>BROWN 03-1110 12 cm</p>	<p>GRAEFE 03-1111 10 cm</p>	<p>GRAEFE 03-1112 With Catch 10 cm</p>	<p>GILLIES 03-1113 15.5 cm</p>	<p>03-1114 LUCAE 1x2 teeth 14 cm</p>	<p>03-1115 TROELTSCH 1X2 teeth 11 cm</p>

Forceps

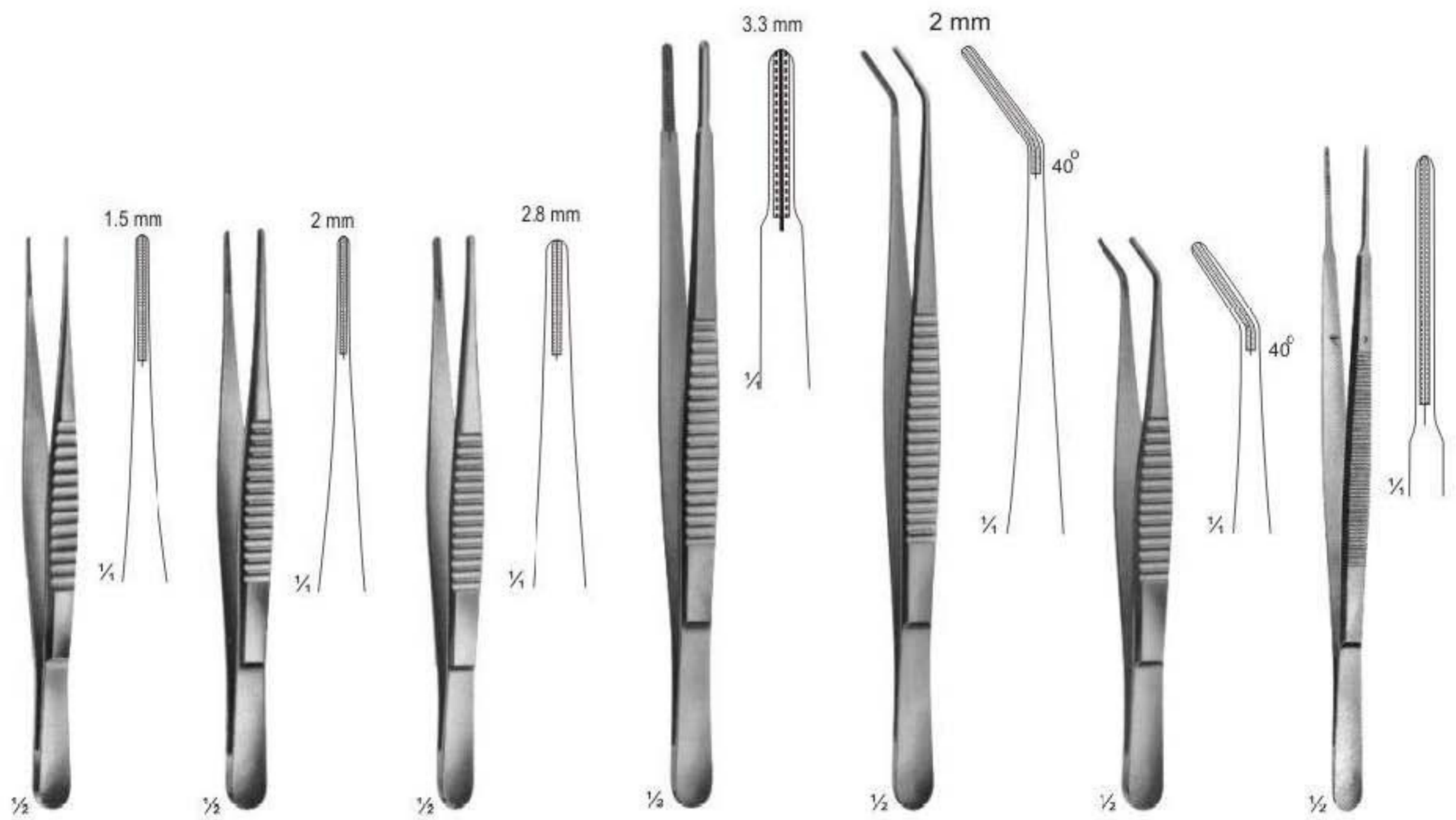

DE BAKEY
03-1116 - 03-1117
03-1116
15 cm
03-1117
20 cm

DE BAKEY
03-1118 - 03-1121
03-1118
15 cm
03-1119
20 cm
03-1120
24 cm
03-1121
30 cm

DE BAKEY
03-1122 - 03-1125
03-1122
15 cm
03-1123
20 cm
03-1124
24 cm
03-1125
30 cm

DE BAKEY
03-1126 - 03-1128
03-1126
20 cm
03-1127
24 cm
03-1128
30 cm

DE BAKEY
03-1129
20 cm

DE BAKEY
03-1130
15 cm

GERALD
03-1131
17.5 cm
03-1132
23 cm

Forceps For Grasping Tissue, Tumors



03-1138
SAMII
Jaws Spoon-Shaped
23 cm

03-1139
SAMII
Jaws Spoon-Shaped
23 cm

- YASARGIL-SAMI
Jaws Spoon-Shaped
- 03-1133**
22 cm 3 mm
- 03-1134**
22 cm 5 mm
- 03-1135**
24 cm 3 mm
- 03-1136**
24 cm 5 mm
- 03-1137**
24 cm 7 mm



HUNT
03-1140
Tumor-and Vessel Forceps
20 cm



HUNT
03-1141
Tumor-and Vessel Forceps
20 cm



YASARGIL
03-1142
Tumor-and Vessel Forceps
20 cm

Tissue Forceps, Lun Dissecting Forceps

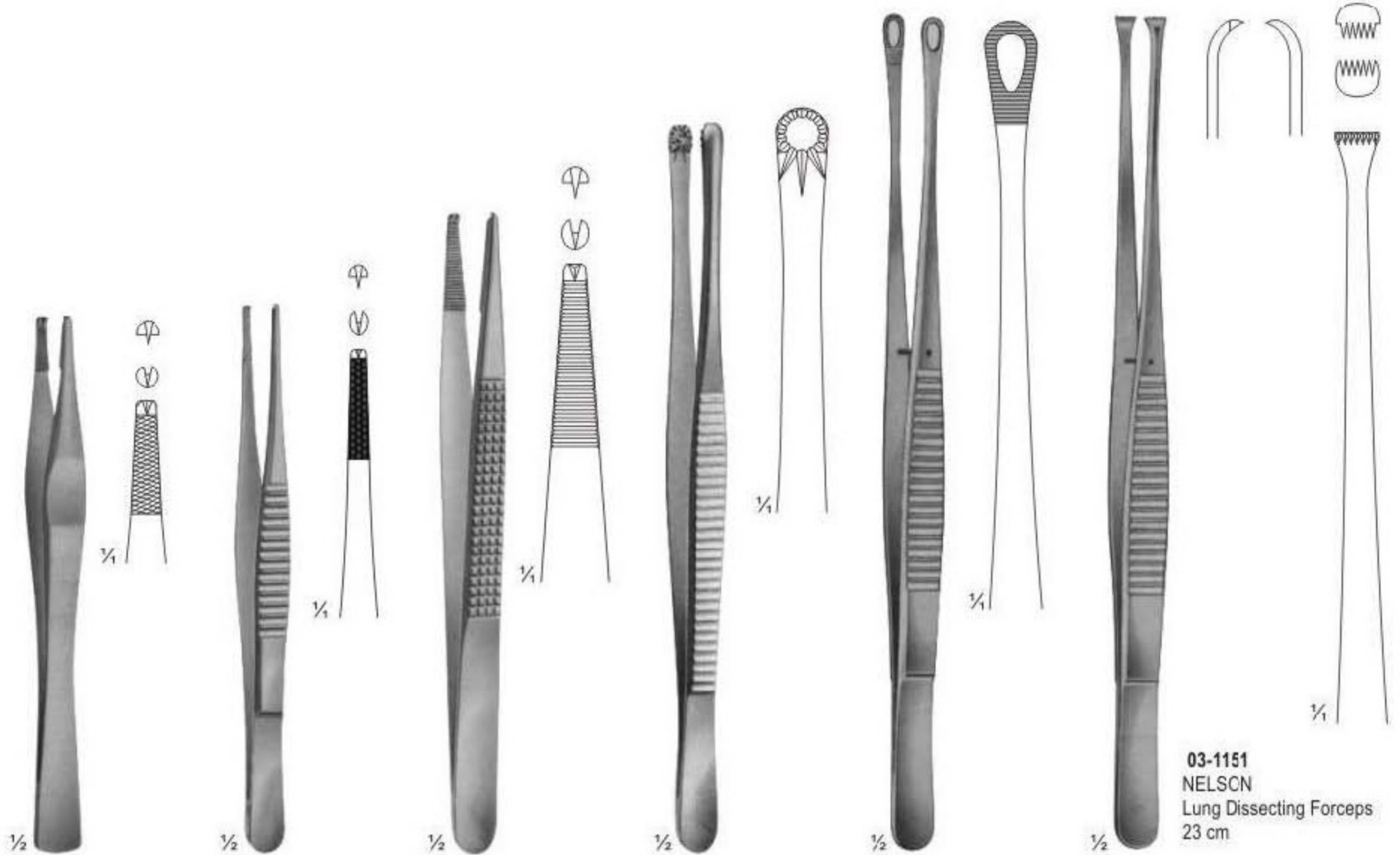

LANE
03-1143
15 cm
03-1144
15 cm
03-1145
17.5 cm

**STRASSBURGER
MODELL**
03-1146
15 cm
03-1147
20 cm

BONNEY
03-1148
17.5 cm

RUSS.MODELL
03-1149
20 cm

TUTTLE
03-1150
Lung Dissecting
Forceps
23 cm

**03-1151
NELSON**
Lung Dissecting Forceps
23 cm



STILLÉ
03-1152
15 cm

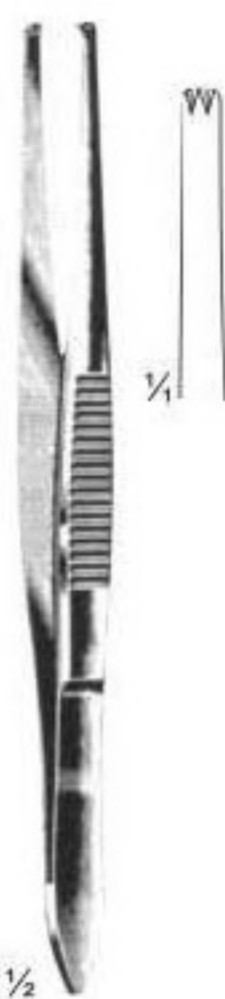

STILLÉ
03-1153
15 cm



STONE
03-1154
15 cm

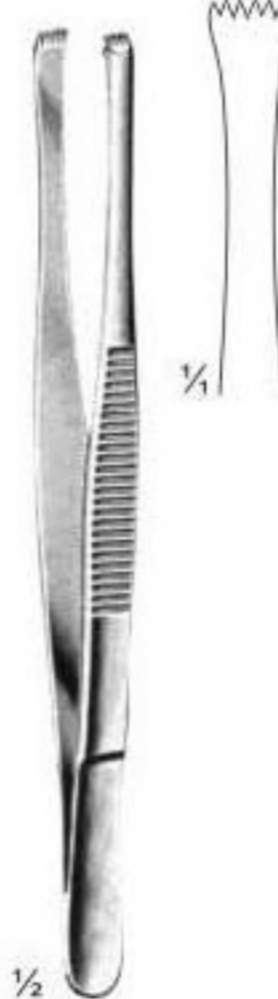

LERSCHE
03-1155
15 cm

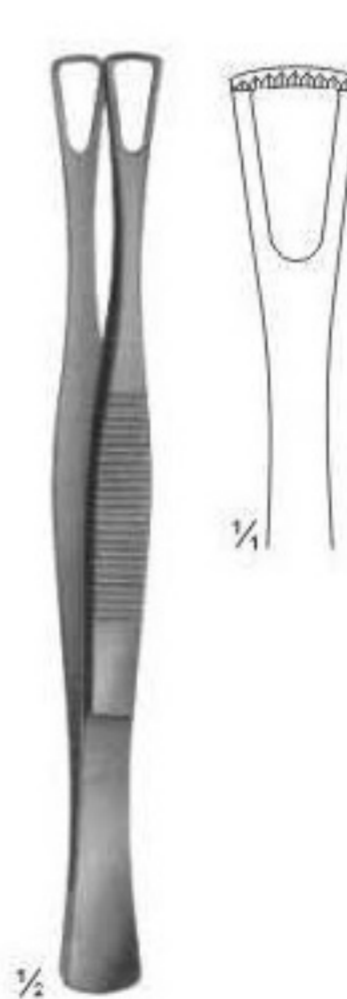

DIVAL
Intestinal Forceps
03-1156
14.5 cm



DENIS-BROWNE
Intestinal Forceps
03-1157
19 cm

Splinter And Cilia Forceps

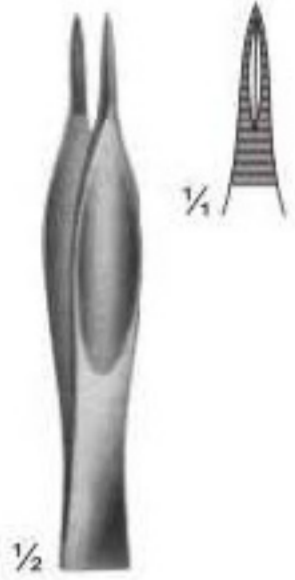

FEILCHENFELD
03-1158
7.5 cm
03-1159
9 cm
03-1160
11.5 cm

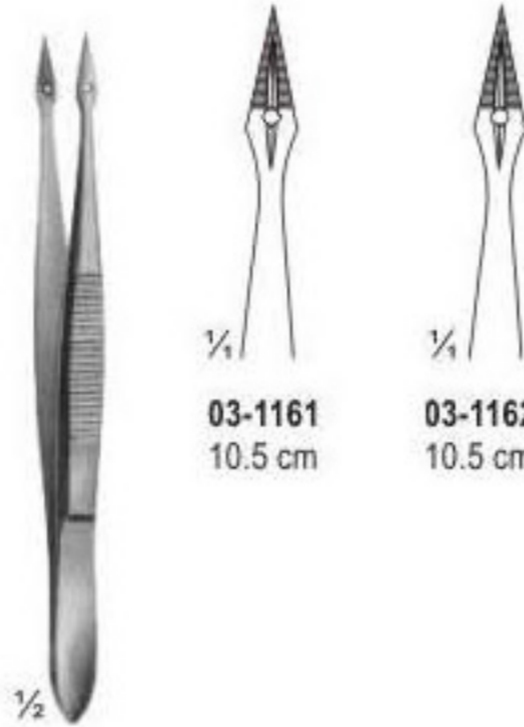

03-1161 - 03-1162
HUNTER

03-1161
10.5 cm

03-1162
10.5 cm



03-1163
PEET
12 cm



STIEGLITZ
03-1164 - 03-1165
14 cm

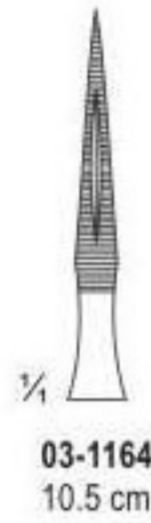

03-1164
10.5 cm

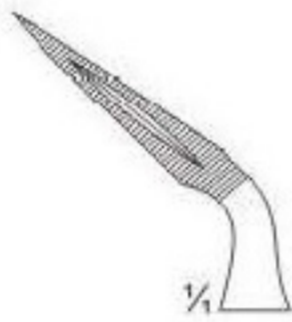

03-1165
10.5 cm



RALK
03-1166 - 03-1167
14 cm



03-1166
15 cm



03-1167
14 cm



BEER
03-1168
9 cm



DOUGLAS
03-1169
9 cm

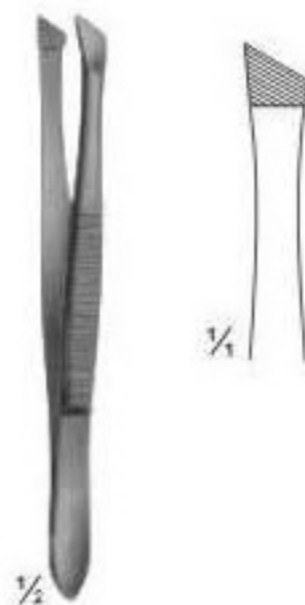

LITTAUER
03-1170
9 cm

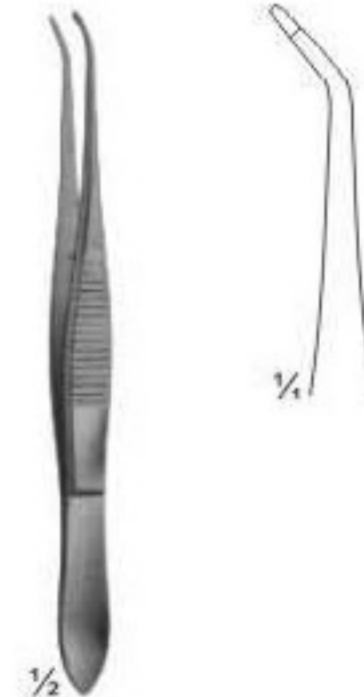

SAUPE
03-1171
10.5 cm



SCHAAF
03-1172
9.5 cm

Delicate Tissue Forceps

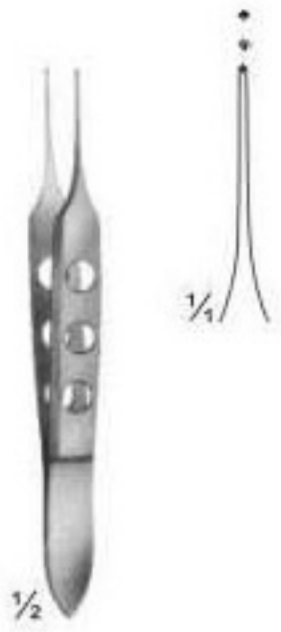

BISHOP-HARMON
03-1173
8.5 cm

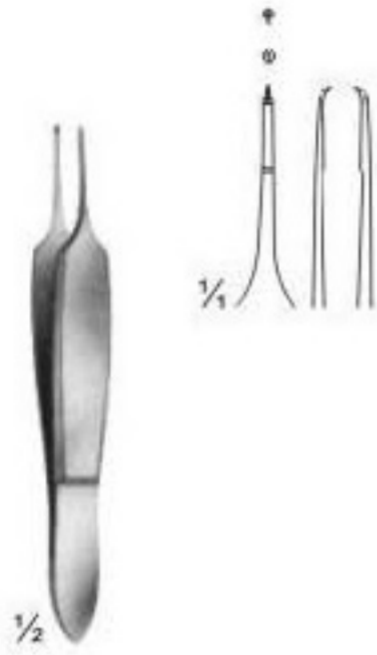

ST.MARTIN
03-1174
8 cm



CASTROVIEJO
03-1175
teeth 0.9 mm
10 cm



CASTROVIEJO
03-1176
teeth 0.5 mm
10 cm

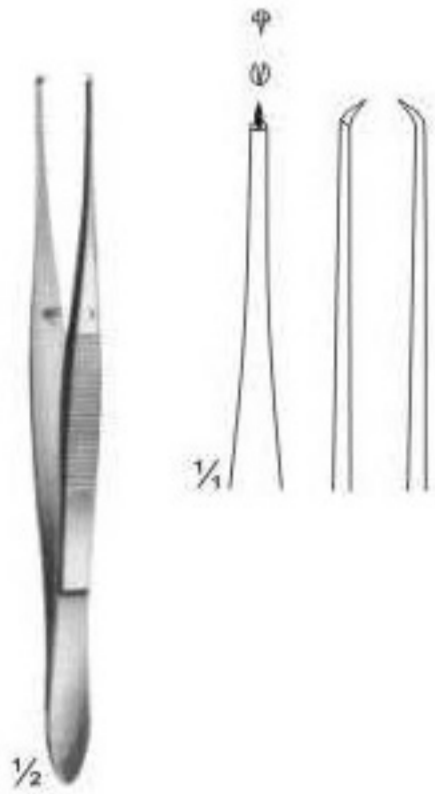

ELSCHING
03-1177
11 cm



GILL
03-1178
7.5 cm



GILL - HESS
03-1179
7.5 cm

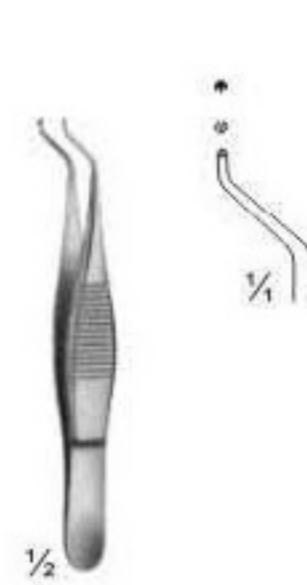

HESS
03-1180
7 cm

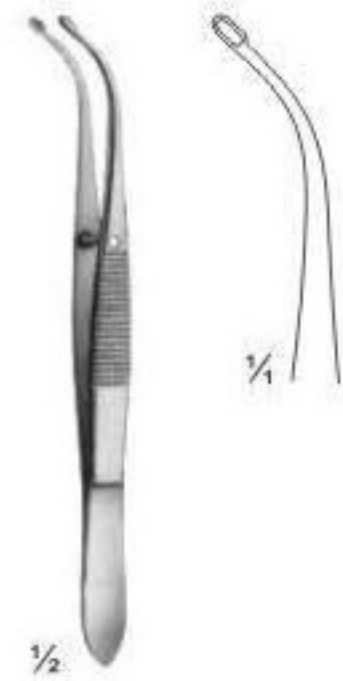

ARRUGA
03-1181
10 cm

Forceps With Tungsten Carbide Inserts



GILLIES
03-1182
15 cm



MC INDOE
03-1183
15 cm



GERALD
03-1184
17 cm



GERALD
03-1185
17 cm



POTTS-SMITH
03-1186 15 cm
03-1187 18 cm
03-1188 20 cm



BONNEY
03-1189 - 03-1190



BONNEY
03-1189
17.5 cm



BONNEY
03-1190
17.5 cm



CUSHING
03-1191 - 03-1192
17.5 cm



03-1191
17.5 cm



03-1192
18 cm



CUSHING-TAYLOR
03-1193
18 cm



OEHLER
03-1194 14 cm
03-1195 16 cm
03-1196 18 cm
03-1197 20 cm
03-1198 25 cm
03-1199 30 cm



Forceps With Tungsten Carbide Inserts



STANDARD
03-1200 14.5 cm
03-1201 16 cm
03-1202 18 cm
03-1203 20 cm
03-1204 25 cm
03-1205 30 cm



STANDARD
03-1206 14.5 cm
03-1207 16 cm
03-1208 18 cm
03-1209 20 cm
03-1210 25 cm
03-1211 30 cm



STANDARD
03-1212 12.5 cm
03-1213 15 cm



WANGENSTEEN
03-1214 15 cm
03-1215 23 cm
03-1216 25 cm



03-1217 12 cm
03-1218 15 cm
03-1219 12 cm
03-1220 15 cm

ADSON
03-1217 - 03-1220



ADSON
03-1221 12 cm
03-1222 12 cm

MICRO ADSON
03-1221 - 03-1222



ADSON-BROWN
03-1223
 12 cm



SEMKEN
 Normal
03-1224 16 cm
03-1225 18 cm
SEMKEN
 Mini
03-1226 16 cm
03-1227 18 cm

SEMKEN
03-1224 - 03-1227

Tissue Forceps



DE BAKEY
03-1228
15 cm
03-1229
20 cm
03-1230
25 cm



DE BAKEY
03-1231
15 cm
03-1232
20 cm
03-1233
25 cm



JABOMA-TC
03-1234
18 cm



JABOMA-TC
03-1235
18 cm



JABOMA-TC
03-1236
18 cm



OBWEGESER
03-1237
16 cm



OBWEGESER
03-1238
18 cm



MERIEM
03-1239

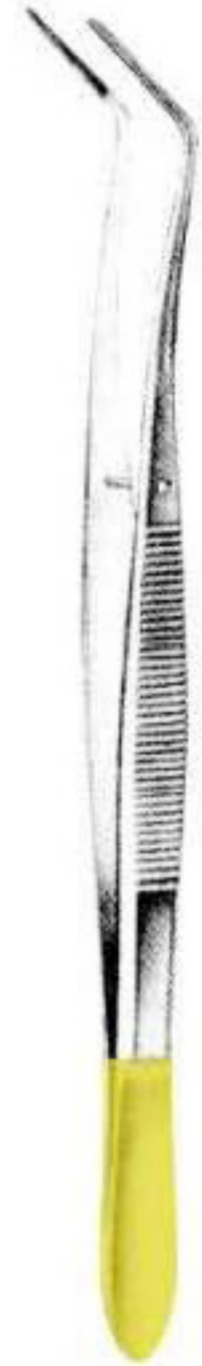

POTTS-NEVINS
03-1240
18 cm

Page 72-97



- Needle Holders
- Suture Instruments - Reverdin Needles & Ligature Needles
- Guiding Probes
- Micro Needle Holders With Round Handles
- Ligature Needles
- Clip Applying Forceps - Suture Set
- Needle Holders With Tungsten Carbide Inserts
- Cervical Biopsy & Specimen Forceps



Suture Instruments - Ligature Needles



HURD
for right hand
sharp
04-1006
21 cm



HURD
for left hand
sharp
04-1007
21 cm



DESCHAMPS
for right hand
sharp
04-1008
21.5 cm



DESCHAMPS
for left hand
sharp
04-1009
21.5 cm



JONESCO
Needle for wire suture
04-1010
18.5 cm

Suture Instruments - Ligature Needles



Suture Instruments - Ligature Needles



DESCHAMPS
for right hand
steep turn blunt
04-1017
23 cm

DESCHAMPS
for left hand
steep turn blunt
04-1013
23 cm

DESCHAMPS
for right hand blunt
04-1019
21.5 cm

DESCHAMPS
for left hand blunt
04-1020
21.5 cm

DESCHAMPS
for right hand blunt
04-1021
21.5 cm

DESCHAMPS
for left hand blunt
04-1022
21.5 cm

Suture Instruments - Ligature Needles

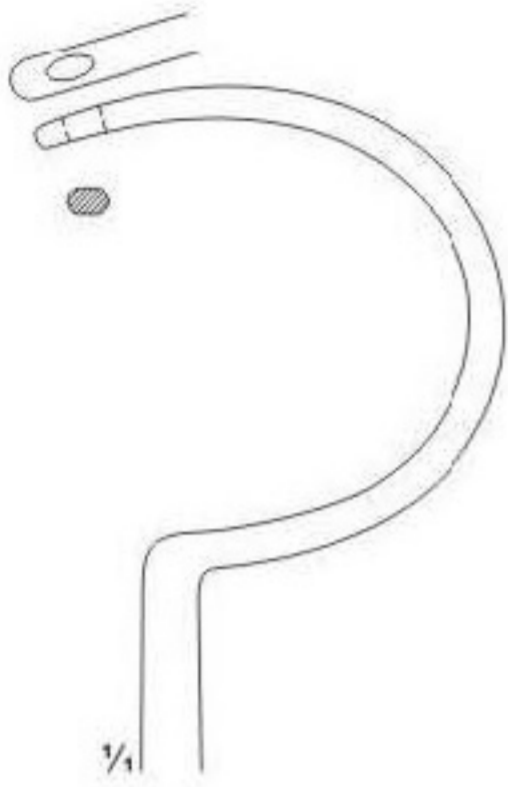

DEMEL
Wire guides
04-1023 - 04-1025
04-1023 27.5 cm
04-1024 28.5 cm
04-1025 30.5 cm



04-1026
22.5 cm

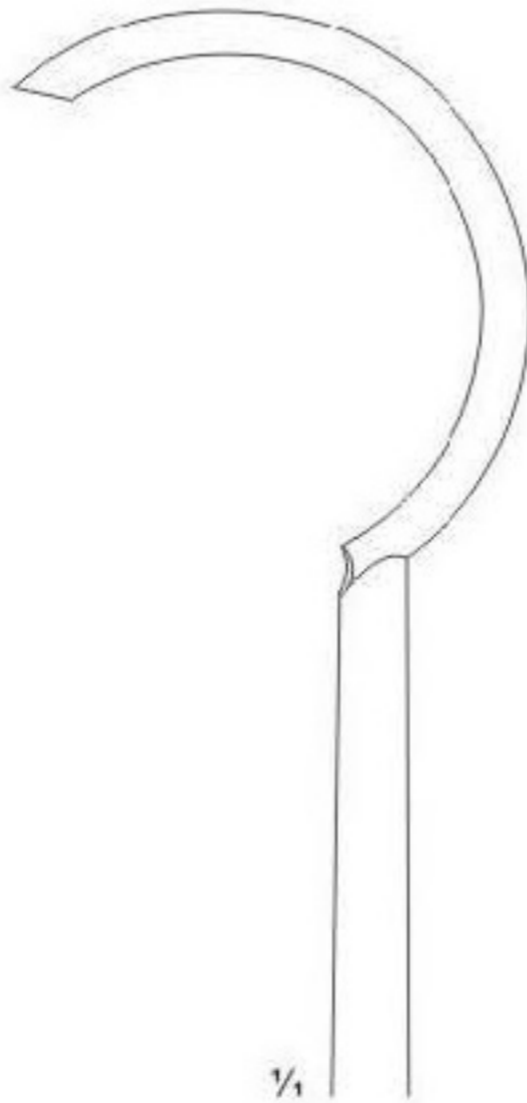

Ligature Needles



BRUNNER
04-1029
24 cm

SCHMIEDEN-DICK
04-1030
32 cm

BRUNNER
Guiding Probes
04-1031 - 04-1034
30 cm

Needle Holders



HEGAR-OLSEN
04-1035 - 04-1036
04-1035 14 cm
04-1036 18.5 cm

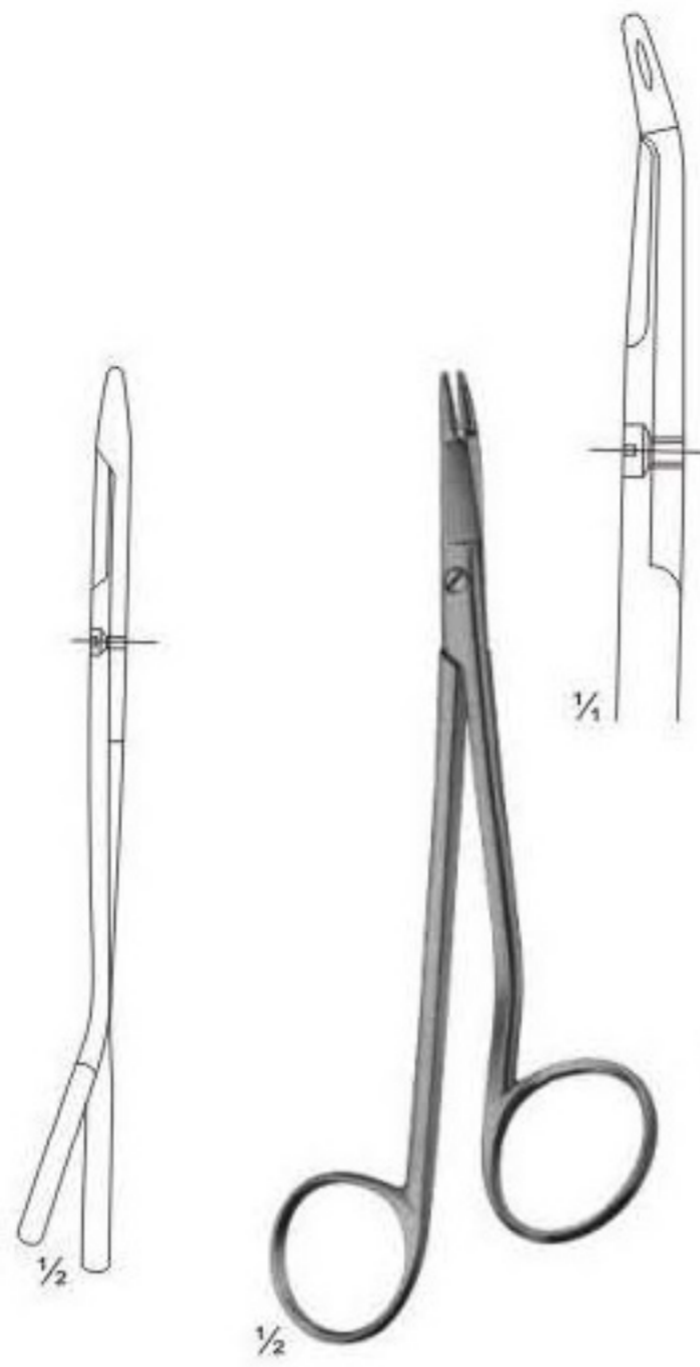

GILLIES
04-1037
15 cm

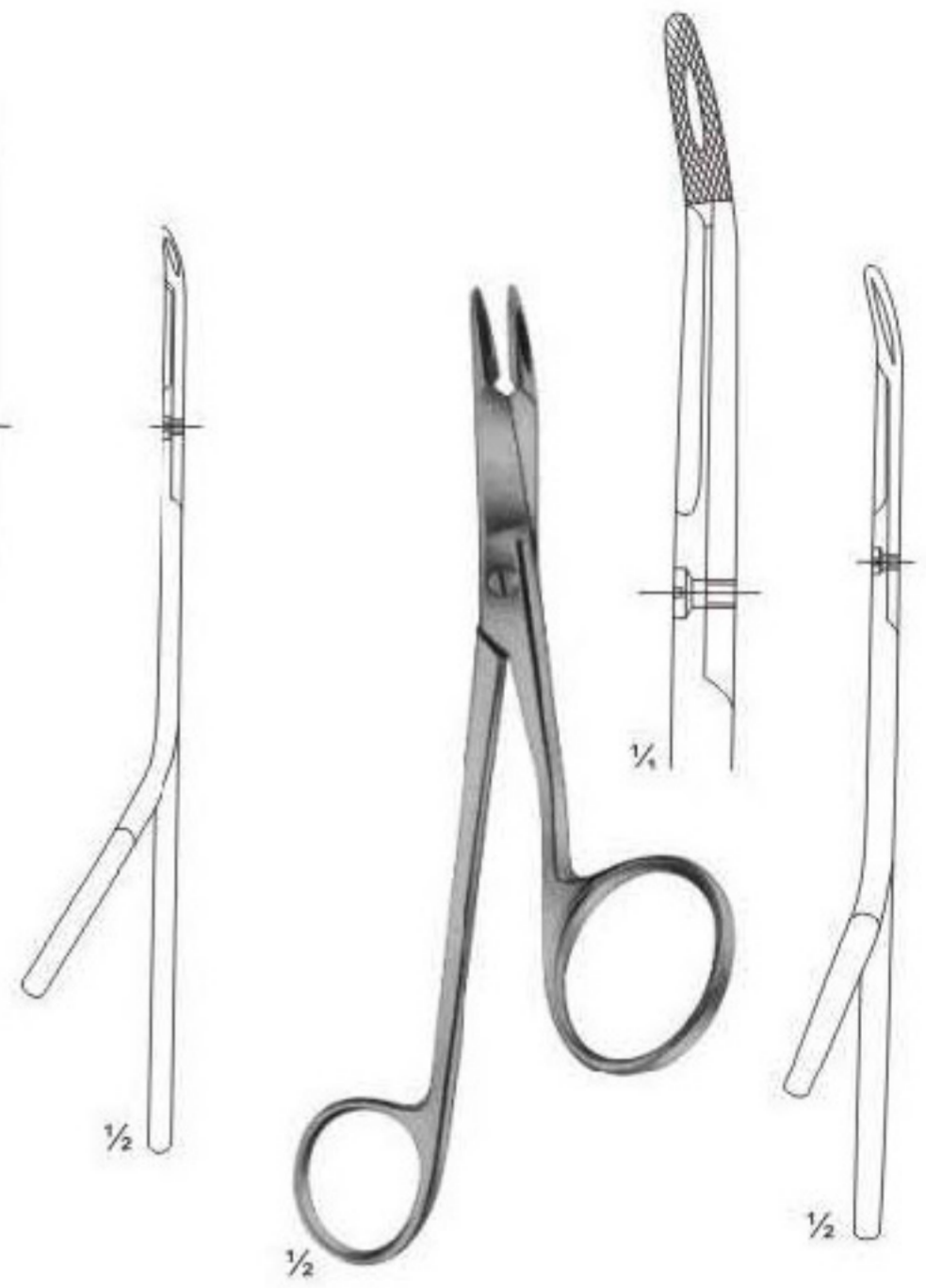

GILLIES
04-1038
16 cm

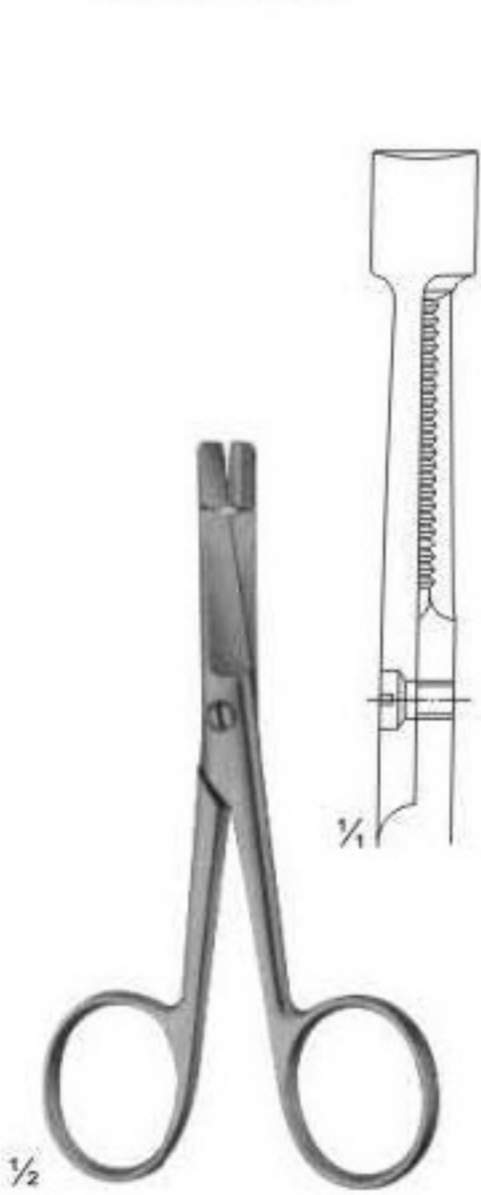

EISELSBERG
04-1039
11.5 cm

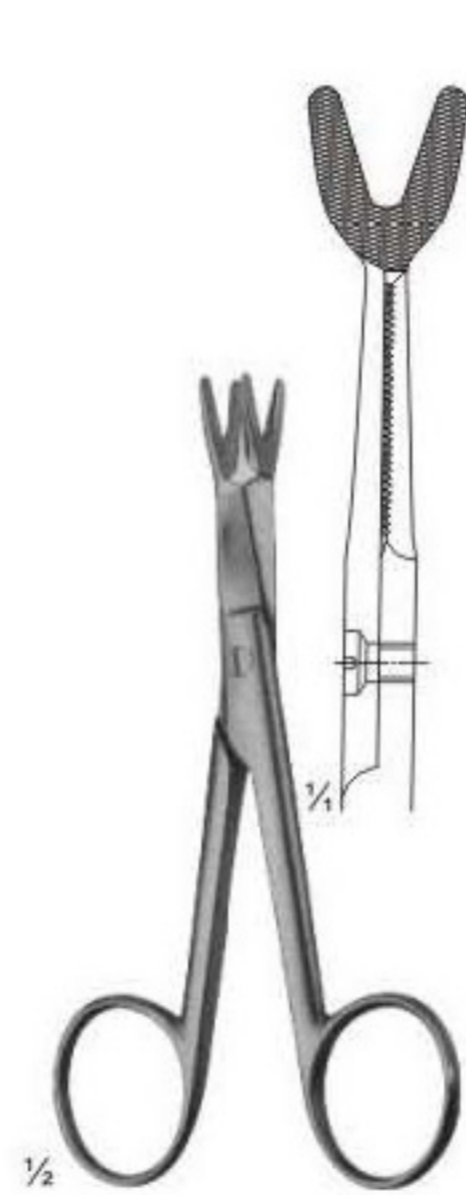

SCHOEMAKER-LOTH
04-1040
12.5 cm



CRILE
04-1041
15 cm



TOENNIS
Elastic pattern for
dura-or intestinal suture
04-1042
18 cm

Needle Holders



MATHIEU
04-1043 - 04-1045
04-1043 14 cm
04-1044 17 cm
04-1045 20 cm



MATHIEU-STILLÉ
Very heavy models
04-1046 - 04-1047
04-1046 17.5 cm
04-1047 20 cm



BOYNTON
04-1048
12.5 cm



EISELSBERG-MATHIEU
04-1049
For palate suture
19.5 cm



MATHIEU-KOCHER
04-1050



BOYNTON
04-1051
12.5 cm



MILLIN
04-1052
Ligature holding forceps
24.5 cm

Needle Holders



CRILE-MURRAY
04-1053
15 cm



CRILE-WOOD
04-1054
16 cm



KILNER
04-1055
13.5 cm



ADSON
04-1056
17.5 cm

Needle Holders



CONVERSE
04-1057
12.5 cm



WEBSTER
04-1058
12.5 cm



HALSEY
04-1059
13 cm



DERF
04-1060
13 cm



HEGAR-BAUMGARTNER
04-1061
14.5 cm



CRILE-WOOD
04-1062
15 cm

Needle Holders



MAYO-HEGAR
Medium fine patterns
04-1063 - 04-1065
04-1063 15 cm
04-1064 18 cm
04-1065 20 cm



HEGAR
Heavy Patterns
04-1066 - 04-1069
04-1066 15 cm
04-1067 17.5 cm
04-1068 20 cm
04-1069 20.5 cm



HEANEY (HEGAR)
04-1070
20 cm

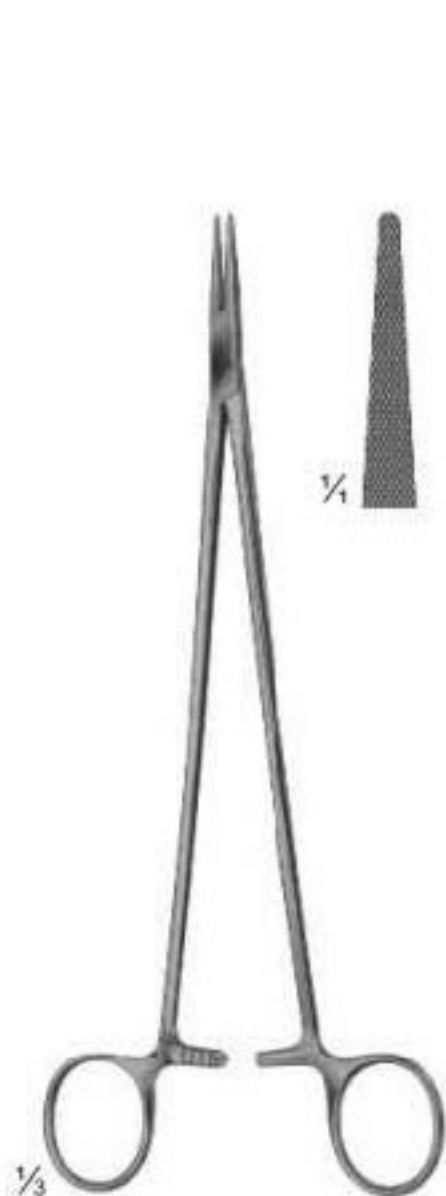

JAMESON
04-1071
23 cm



WANGENSTEEN
04-1072
27.5 cm



MASSON
04-1073
26.5 cm

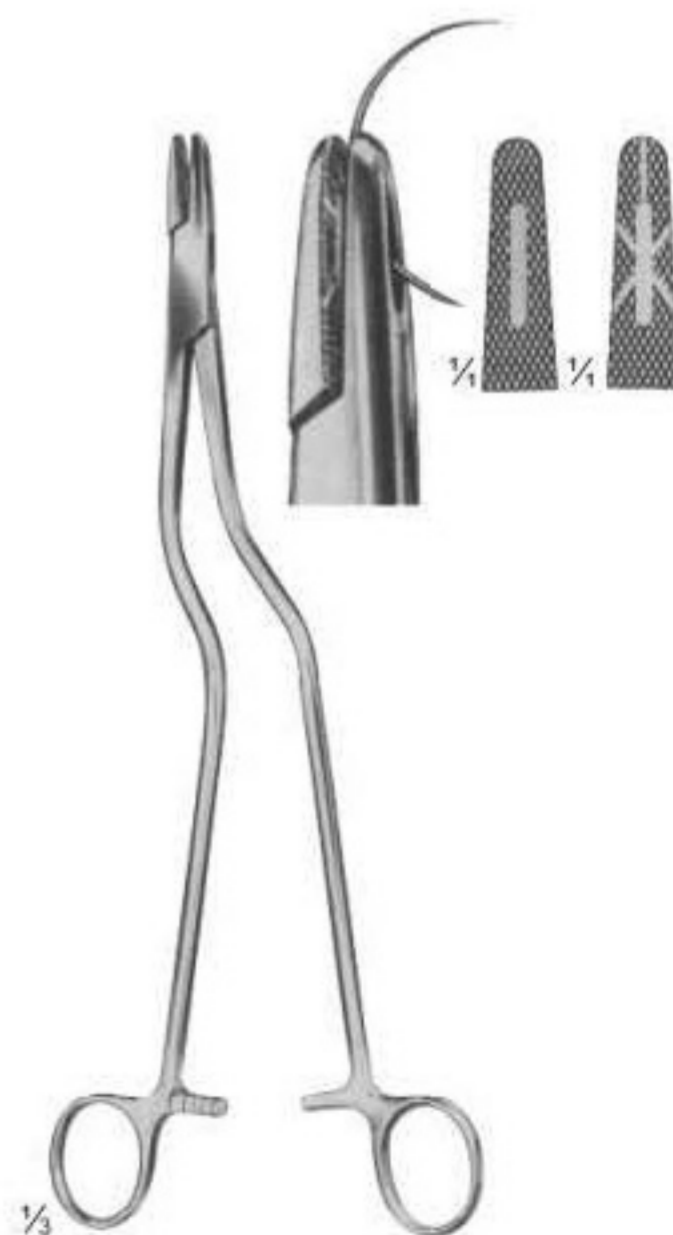

MASSON-LUETHY
04-1074
25.5 cm

Micro Needle Holders With Round Handles

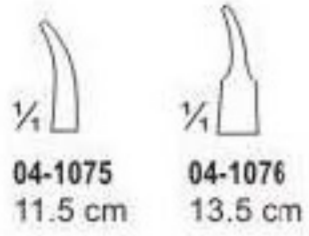

04-1075
11.5 cm

04-1076
13.5 cm

04-1075 - 04-1076
BARRAQUER
Without catch

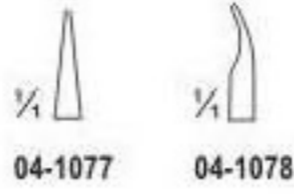

04-1077

04-1078

BARRAQUER
Without catch
04-1077 - 04-1078
12 cm

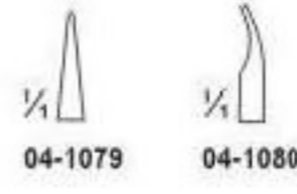

04-1079

04-1080

BARRAQUER
With catch
04-1079 - 04-1080
12 cm

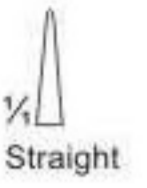

BARRAQUER
With Catch
04-1081
15 cm

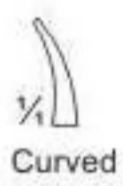

BARRAQUER
With Catch
04-1082
15 cm



MULLER
With Locking
Mechanism
04-1083
14.5 cm

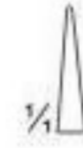

BROCK
Without catch
04-1084
15 cm



BROCK
Without catch
04-1085
15 cm

Micro Needle Holders With Round Handles



$\frac{1}{4}$
Straight

$\frac{1}{2}$
YASARGIL
04-1086
20 cm



$\frac{1}{4}$
Curved

YASARGIL
04-1087
20 cm



$\frac{1}{4}$

YASARGIL
04-1088
22.5 cm



$\frac{1}{4}$

YASARGIL
04-1089
22.5 cm



$\frac{1}{4}$

YASARGIL
04-1090
24.5 cm

Guiding Probes

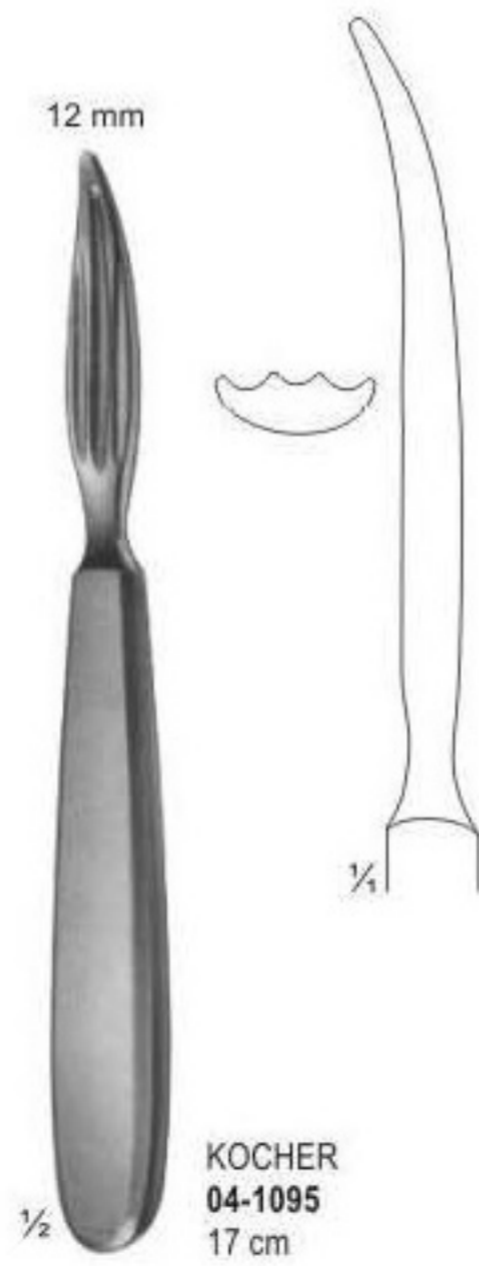
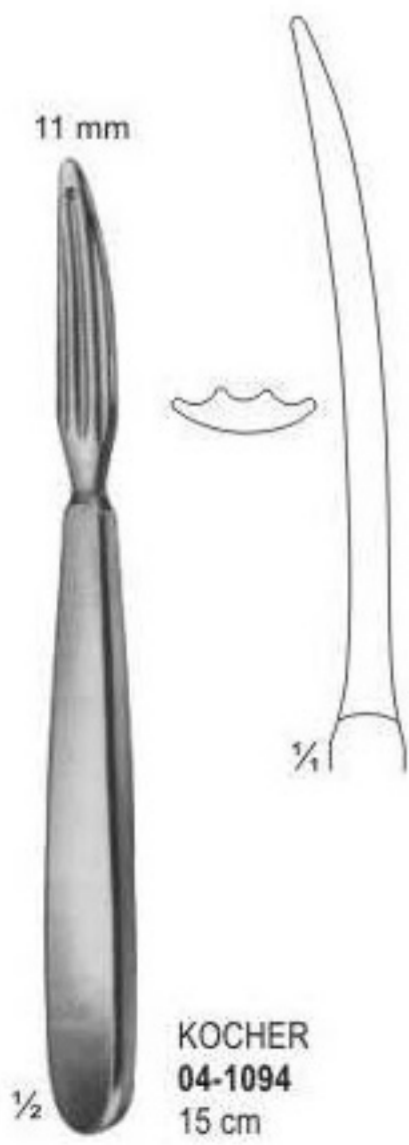

Guiding Probes

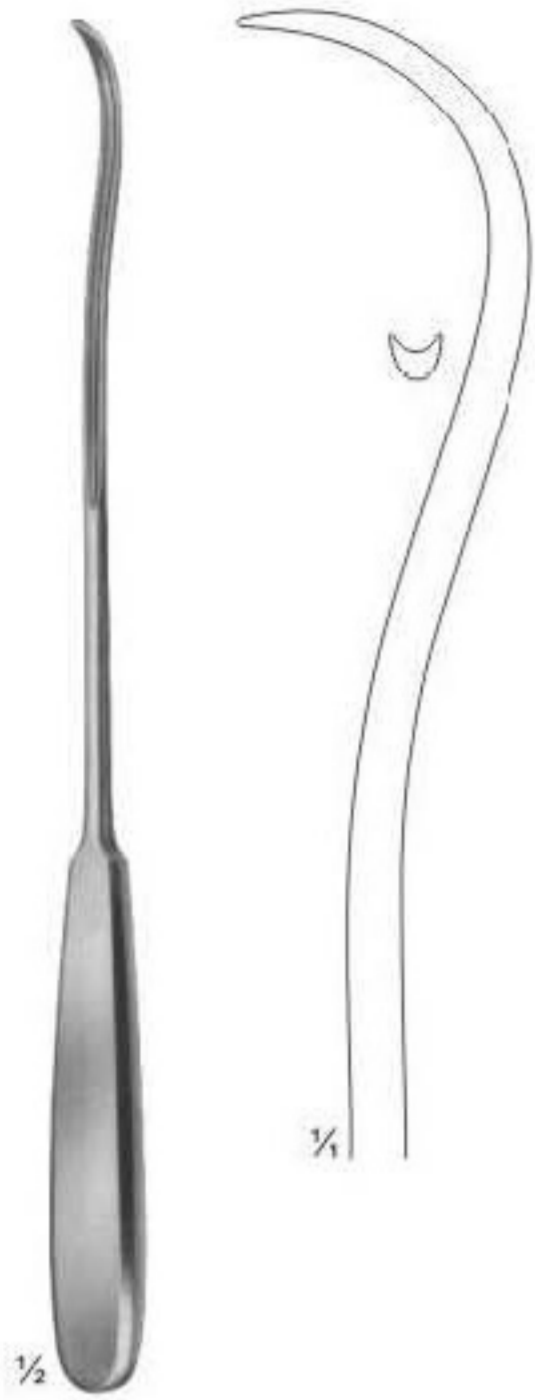

04-1098
28 cm



KIRSCHNER
04-1099
25.5 cm



BRUNNER
04-1100
24.5 cm



Ligature Adjuster
04-1101
23 cm



CASPER
Ligature Adjuster
04-1102
23 cm



WIENER MODEL
Suture hook
04-1103
23.5 cm

Clip Applying Forceps - Suture Set



$\frac{1}{2}$
MICHEL
04-1104
12.5 cm



$\frac{1}{2}$
HEGENBARTH
04-1105
12 cm



$\frac{1}{2}$
WACHENFELDT
04-1106
12 cm



$\frac{1}{2}$
WACHENFELDT
04-1107
12 cm



$\frac{1}{2}$
MICHEL
04-1108
12.5 cm



$\frac{1}{2}$
MICHEL modif.
04-1109
13 cm



$\frac{1}{2}$
HEATH
04-1110
13.5 cm



$\frac{1}{2}$
COLLIN
04-1111
13.5 cm

Suture Instruments - Reverdin Needles



Fig. 1
04-1112

Fig. 2
04-1113

Fig. 3
04-1114

Fig. 4
04-1115

REVERDIN
04-1112 - 04-1115
14 cm

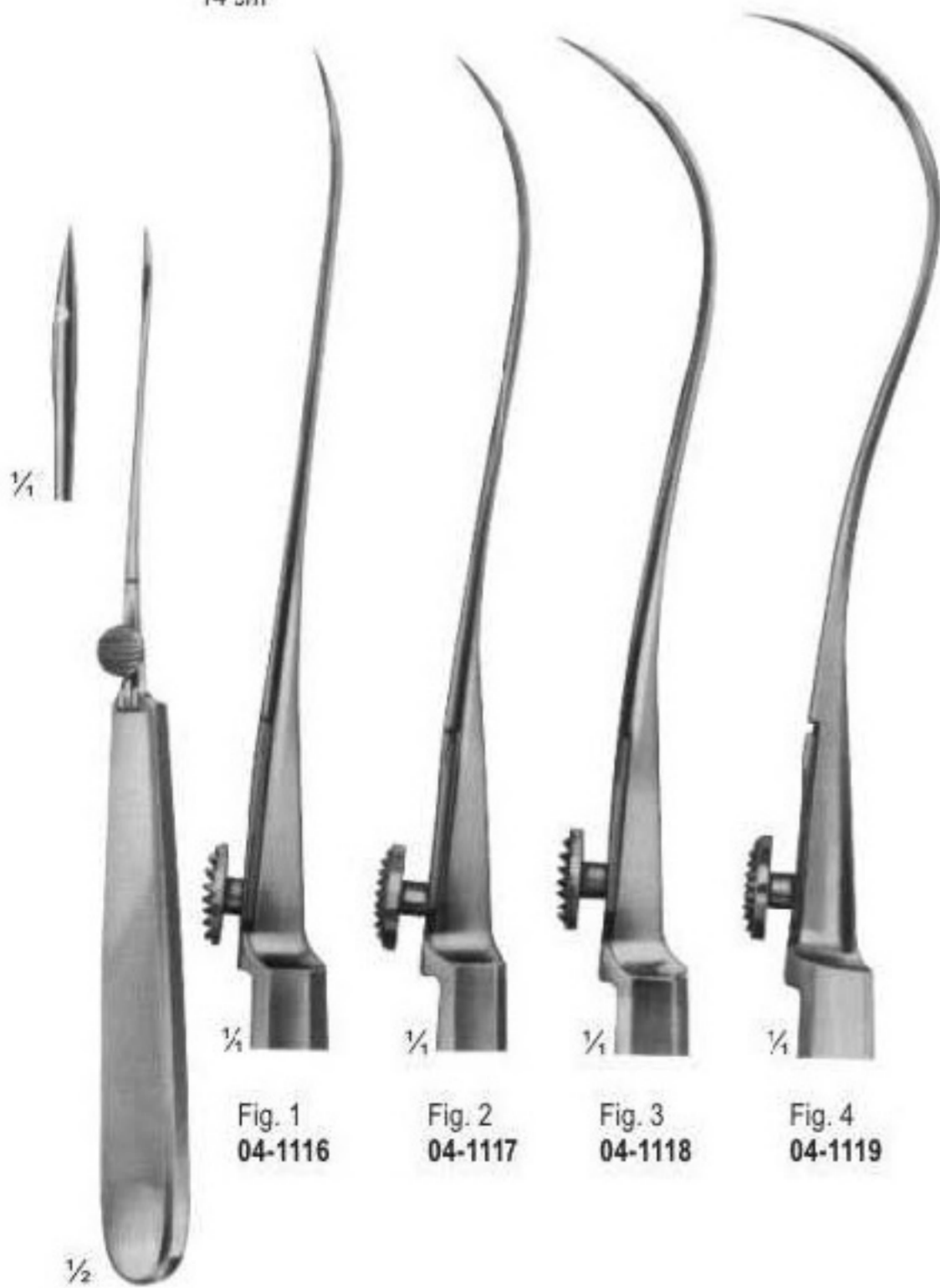

Fig. 1
04-1116

Fig. 2
04-1117

Fig. 3
04-1118

Fig. 4
04-1119

REVERDIN
04-1116 - 04-1119
19.5 cm



Fig. 1
04-1120

Fig. 2
04-1121

Fig. 3
04-1122

Fig. 4
04-1123

REVERDIN
04-1120 - 04-1123
22.5 cm

Needle Holders With Tungsten Carbide Inserts



KALT
04-1124
13.5 cm



DIETRICH
04-1125 - 04-1129
04-1125 16 cm
04-1126 18 cm
04-1127 20 cm
04-1128 23 cm
04-1129 26 cm



WEBSTER
04-1130
13 cm



DERF
04-1131
12 cm



HEGAR-BAUMGARTNER
04-1132 - 04-1133
04-1132 12.5 cm
04-1133 14 cm



WEBSTER
04-1134
13 cm

Needle Holders With Tungsten Carbide Inserts



HALSEY
04-1135 - 04-1136
13 cm



CRILE-WOOD
04-1137 - 04-1138
04-1137 15 cm
04-1138 18 cm



SAROT
04-1139 - 04-1141
04-1139 18 cm
04-1140 20 cm
04-1141 26 cm

Needle Holders With Tungsten Carbide Inserts



MAYO-HEGAR
04-1142 - 04-1147
04-1142 16 cm
04-1143 18 cm
04-1144 20 cm
04-1145 24 cm
04-1146 26 cm
04-1147 30 cm



MAYO-HEGAR (HEANEY)
04-1148 - 04-1150
04-1148 20 cm
04-1149 24 cm
04-1150 26 cm



DE BAKAY
04-1151 - 04-1156
04-1151 18 cm
04-1152 20 cm
04-1153 23 cm
04-1154 26 cm
04-1155 31 cm
04-1156 37 cm



RYDER-VASCULAR
04-1157 - 04-1162
04-1157 13 cm
04-1158 15 cm
04-1159 18 cm
04-1160 20 cm
04-1161 23 cm
04-1162 26 cm

Needle Holders With Tungsten Carbide Inserts



RYDER
04-1163 - 04-1168
04-1163 13 cm
04-1164 15 cm
04-1165 18 cm
04-1166 20 cm
04-1167 23 cm
04-1168 26 cm

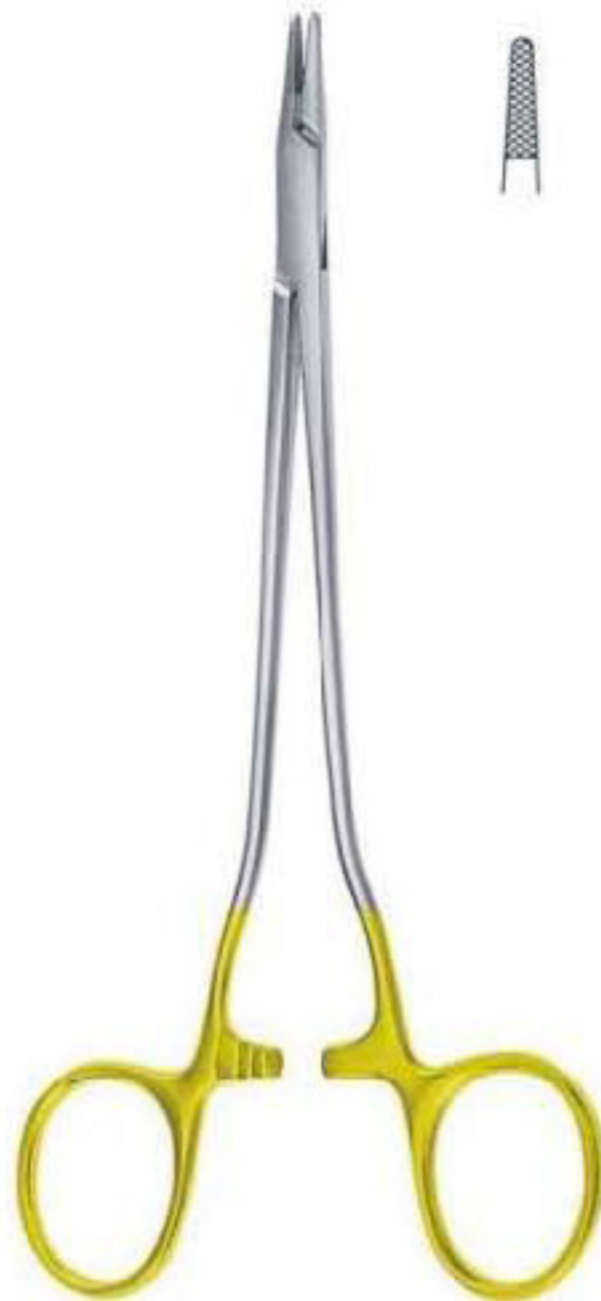

SCHWEDISCHES MODELL
04-1169 - 04-1171
04-1169 15 cm
04-1170 17 cm
04-1171 20 cm

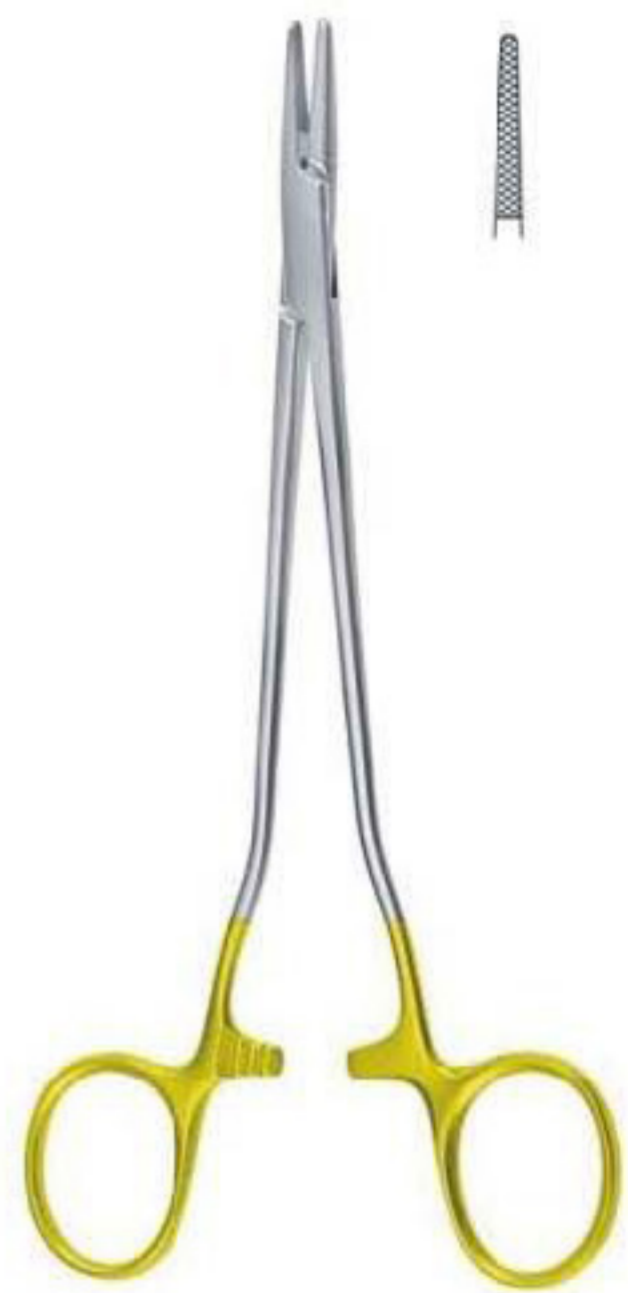

MAYO-HEGAR (HEANEY)
04-1172 - 04-1175
04-1172 14 cm
04-1173 18 cm
04-1174 20 cm
04-1175 23 cm



FINOCCHIETTO
04-1176
27 cm



MASSON
04-1177
27 cm



WANGENSTEEN
04-1178
27 cm

Needle Holders With Tungsten Carbide Inserts

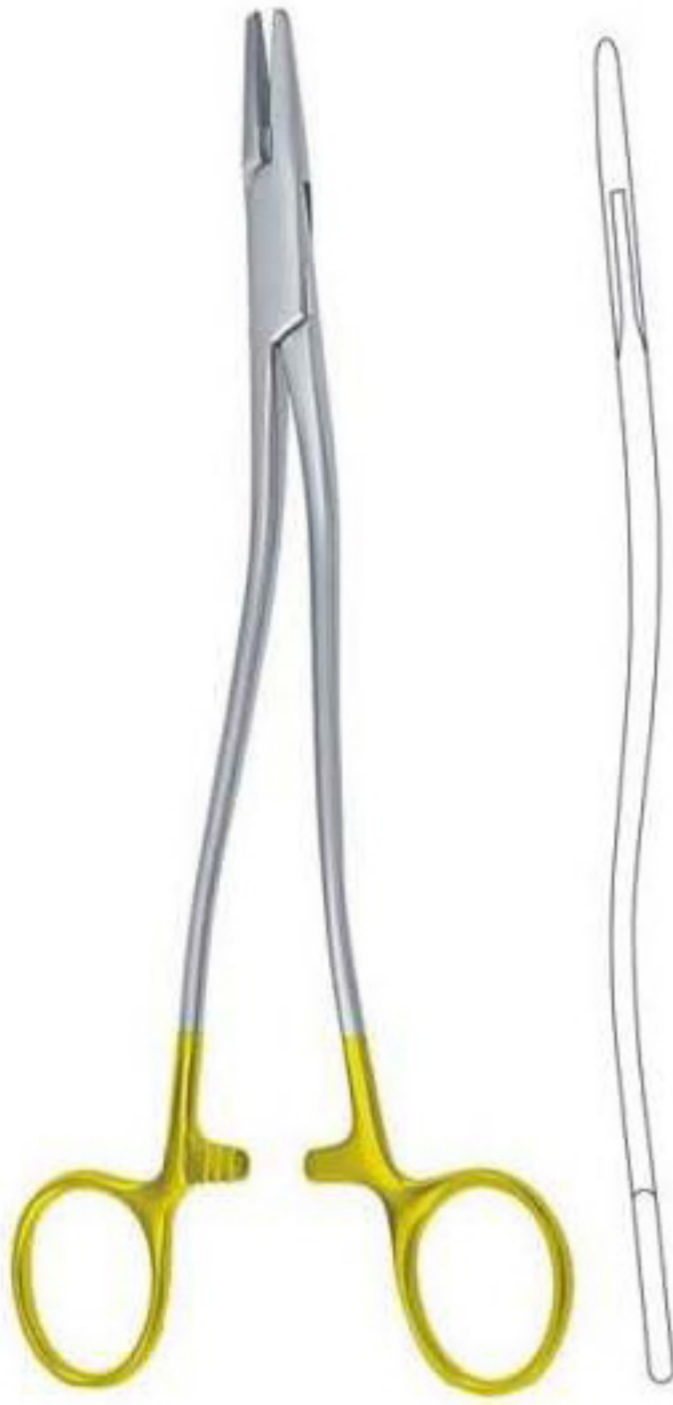

BOZEMANN
04-1179 - 04-1181
04-1179 20 cm
04-1180 24 cm
04-1181 26 cm



BARRY STERNAL
04-1182 - 04-1183

04-1182
FOR STERNUM
SUTURE
15 cm

04-1183
WIRE TWISTER
20 cm



HEGAR
04-1184 - 04-1185
04-1184 20 cm
04-1185 24 cm

Needle Holders With Tungsten Carbide Inserts



STRATTE
04-1186 - 04-1187
04-1186 22 cm
04-1187 23 cm



GILLIES
04-1188
16 cm



OLSEN-HEGAR
04-1139 - 04-1191
04-1139 14 cm
04-1190 17 cm
04-1191 18 cm



TOENNIS
04-1192
18 cm

Needle Holders With Tungsten Carbide Inserts



LICHTENBERG
04-1193 - 04-1194
04-1193 17 cm
04-1194 20 cm



MATHIEU-KOCHER
04-1195 - 04-1197
04-1195 14 cm
04-1196 17 cm
04-1197 20 cm



MATHIEU
04-1198 - 04-1200
04-1198 14 cm
04-1199 17 cm
04-1200 20 cm



MATHIEU
04-1201 - 04-1203
04-1201 14 cm
04-1202 17 cm
04-1203 20 cm



ZWEIFEL
04-1204 - 04-1205
04-1204 20 cm
04-1205 23 cm



LANGENBECK
04-1206 - 04-1208
04-1206 18 cm
04-1207 20 cm
04-1208 23 cm

Needle Holders With Tungsten Carbide Inserts



04-1209



04-1210



04-1211



04-1212



04-1213



04-1214



04-1215



04-1216

CASTROVIEJO
04-1209 - 04-1212
14.5 cm

CASTROVIEJO
04-1213 - 04-1216
18 cm



04-1217



04-1218



04-1219



04-1220

BARRAQUER
04-1217 - 04-1220
14.5 cm



HEPF SCHEIDEL
04-1221
18 cm

Cervical Biopsy And Specimen Forceps

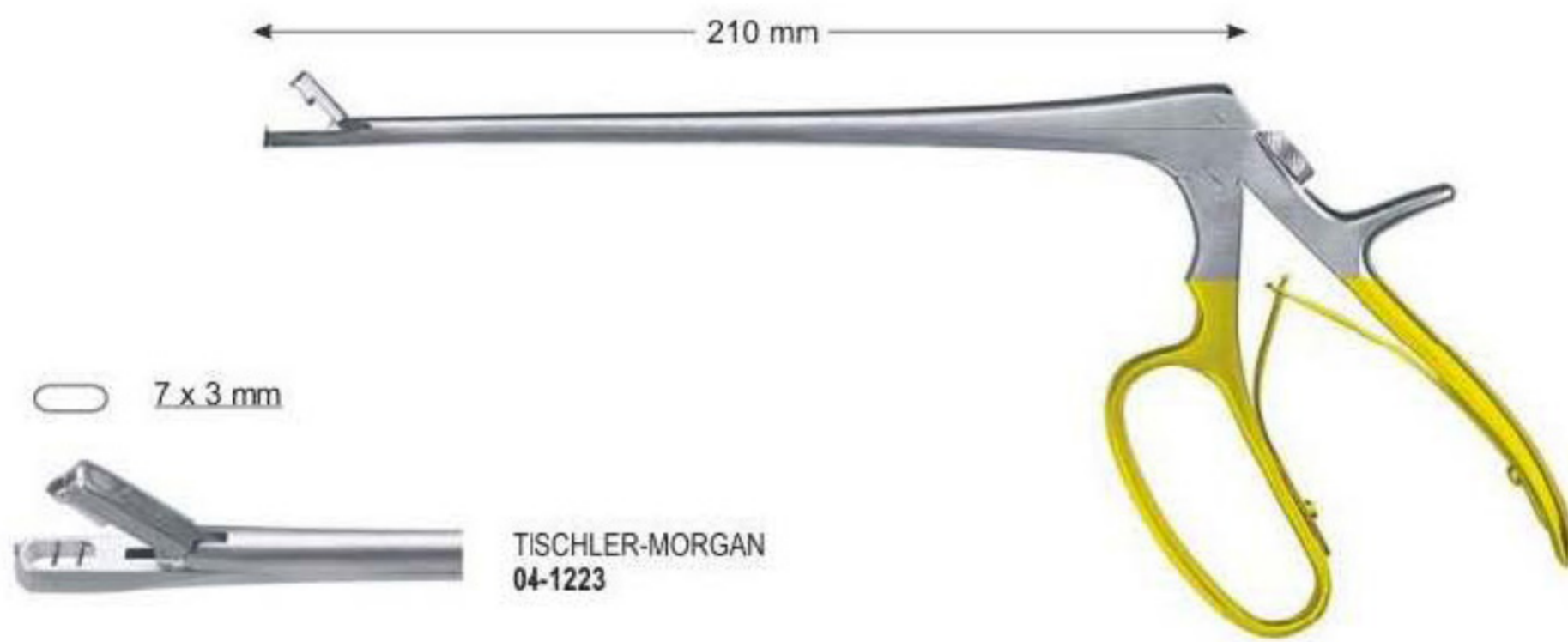
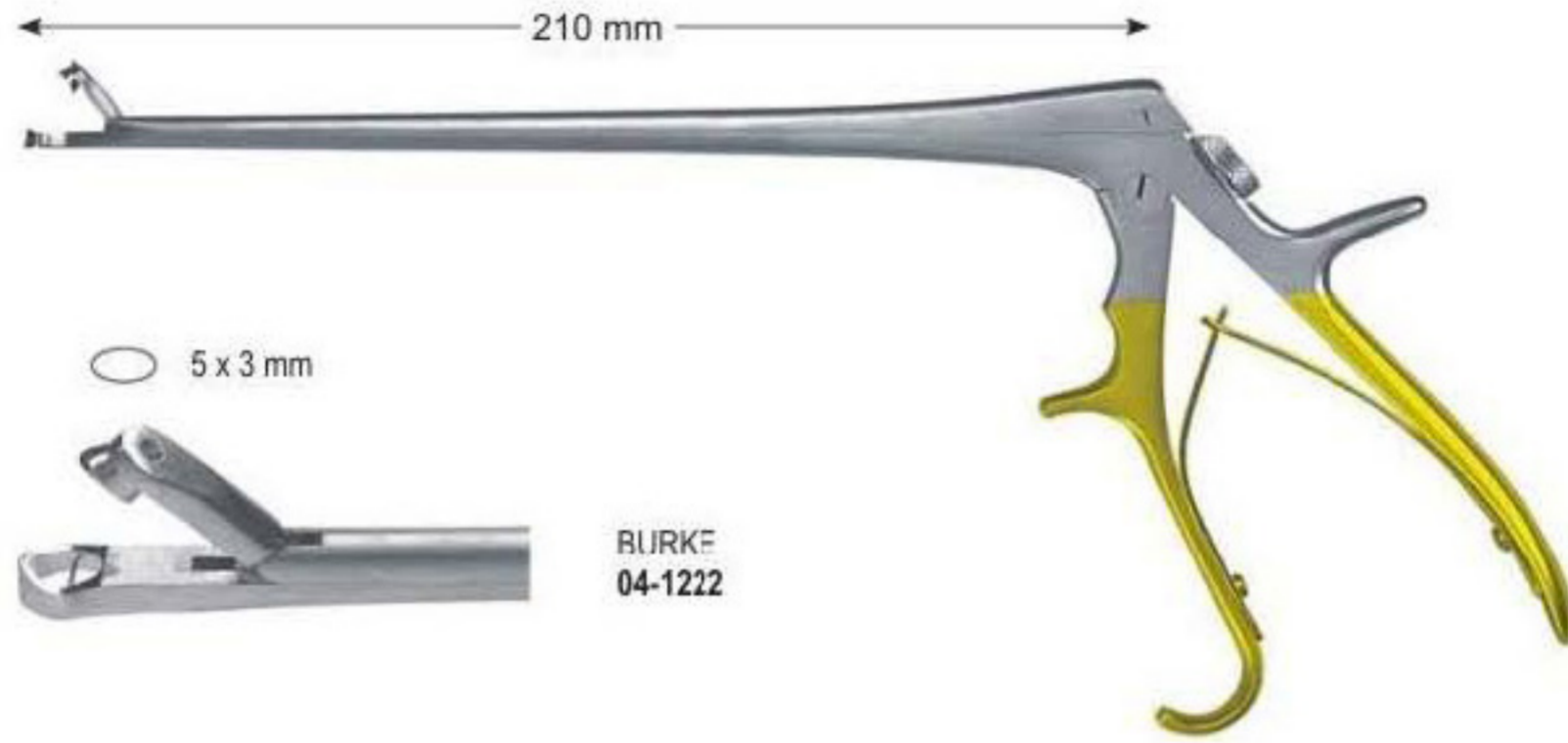

Page 98-102

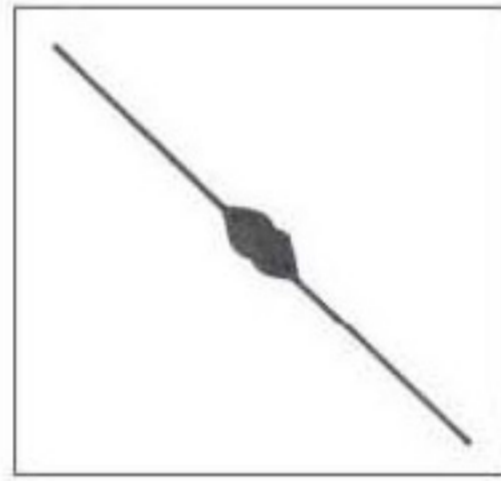
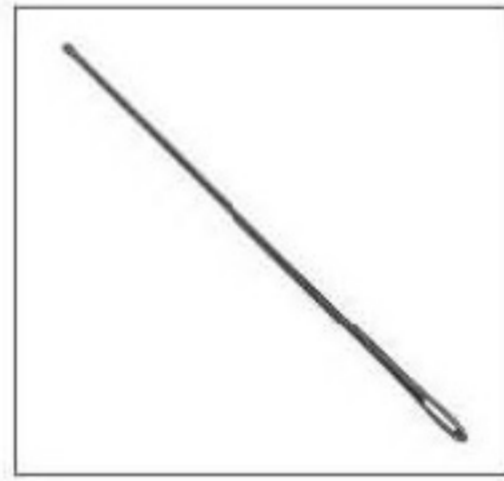

- Probes
- Probes - Spatulas - Cotton Applicators
- Cotton Applicators
- Clip Applying Forceps - Suture Set



Probes

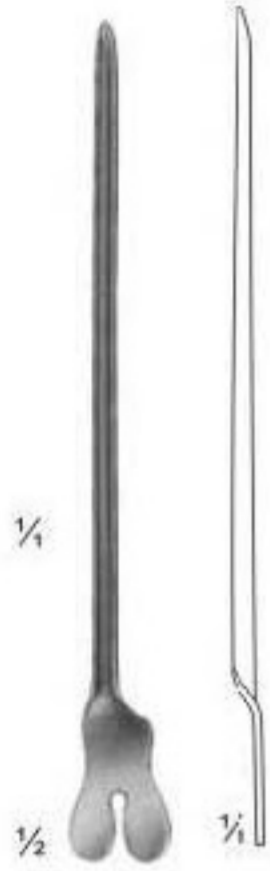

05-1001 - 05-1003
05-1001 13 cm
05-1002 14.5 cm
05-1003 16 cm
 Directors



DOYEN
05-1004
 14.5 cm
 Directors



NELATON
05-1005
 16 cm
 Directors



05-1006
 Director with tip
 Diam. Of tip 3,3 mm
 14 cm

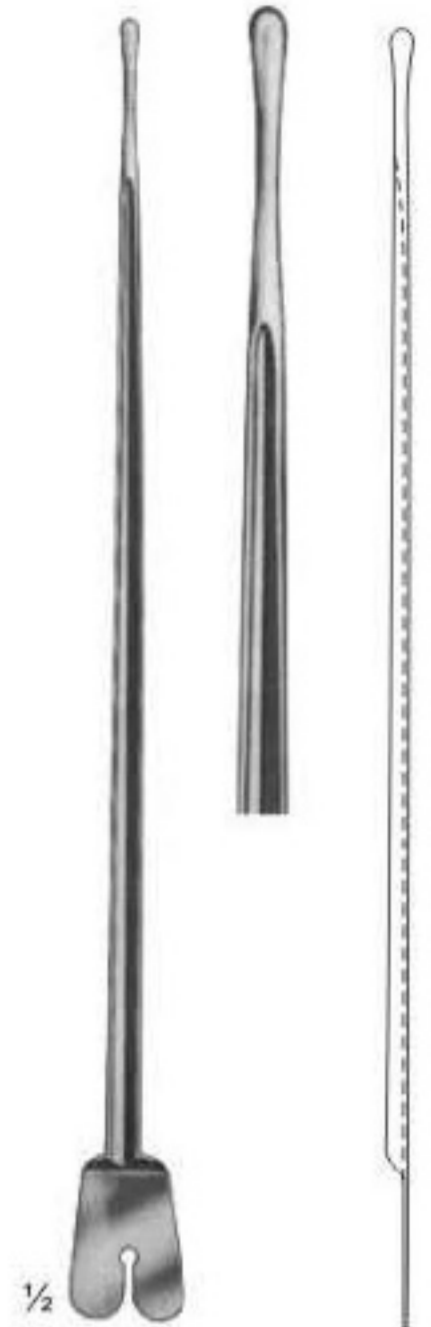

BRODIE
05-1007
 Director with tip,
 Diam. Of tip 3,5 mm
 20 cm

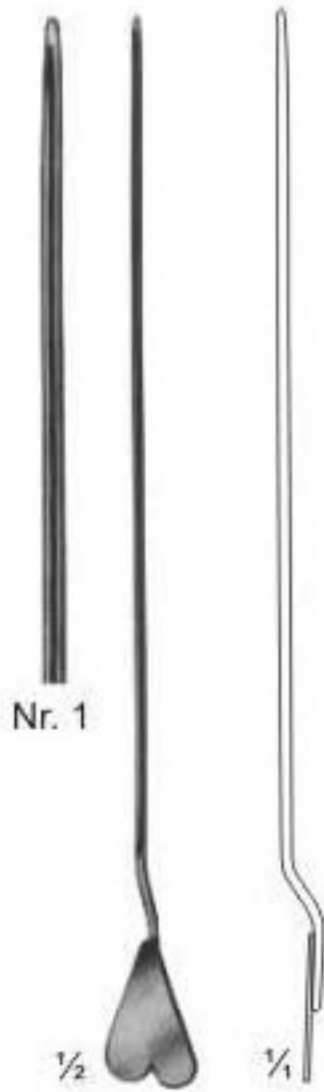

LOCKHART-MUMMERY
05-1008
 16.5 cm

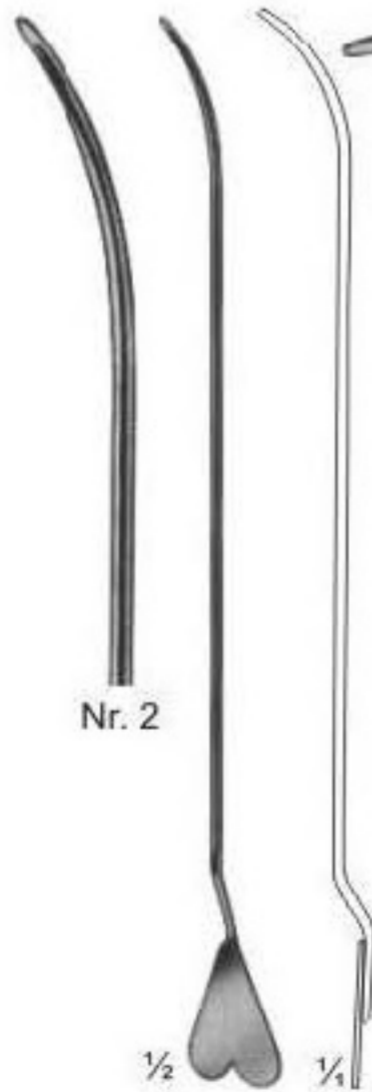

LOCKHART-MUMMERY
05-1009
 16.5 cm

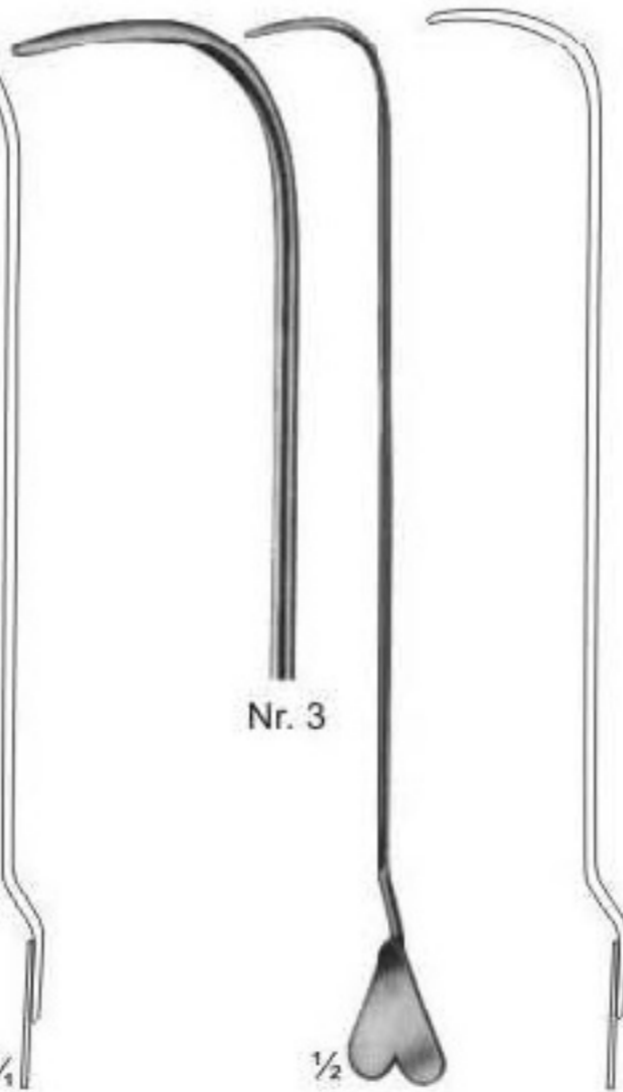

LOCKHART-MUMMERY
05-1010
 16.5 cm

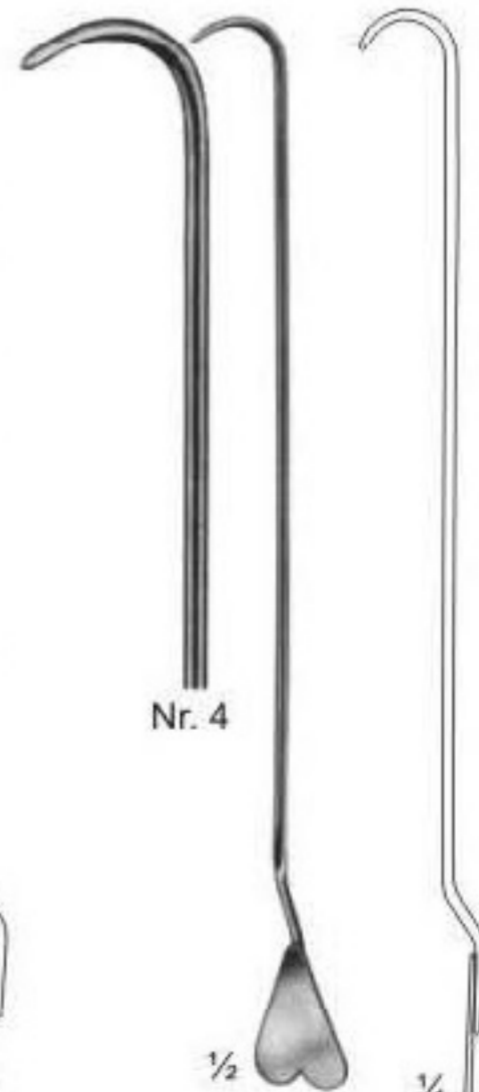

LOCKHART-MUMMERY
05-1011
 16.5 cm



05-1012
 Director with wire
 loop, malleable
 19 cm

Probes



PROBES
05-1013 - 05-1015
05-1013 13 cm
05-1014 14 cm
05-1015 16 cm
Probes with eye



PROBES
05-1016
Myrtle leaf probe
14.5 cm



PROBES
05-1017 - 05-1021
05-1017 13 cm
05-1018 14.5 cm
05-1019 16 cm
05-1020 18 cm
05-1021 20 cm



PROBES
05-1022
Probes



PROBES
05-1023
Double ended probe,
malleable, diam. of tips
3 mm with hole
19 cm



PROBES
05-1024
Double ended probes,
tin, malleable,
diam. of tips
3,5 mm with hole
25 cm, 30 cm



PROBES
05-1025
Double ended probes,
tin, malleable,
diam. of tips 4 mm
40 cm



PROBES
05-1026 - 05-1028
05-1026 1.5 mm
05-1027 2 mm
05-1028 2.5 mm
30 cm

Probes - Spatulas - Cotton Applicators



STACKE
05-1029
10 cm



KILLIAN
05-1030
16.5 cm



05-1031
16 cm



SEIFFERT
05-1032
18 cm



BOWMAN
05-1033
13 cm



SPATULA
05-1034
14.5 cm

SPATULA
05-1035
14.5 cm



05-1036
Modell PICCOLO
Round Serated
11 cm



05-1037
Modell PICCOLO
Triangular Serrated end
11 cm



FARRELL
05-1038
Round Serrated end
11 cm



LATHBURY-FARREL
05-1039
Triangular Serrated end
11 cm

Cotton Applicators



BUCK
05-1040
Rough, spiral end
12 cm



05-1041
Triangular
serrated end
14 cm



05-1042
Rough, spiral end
14 cm



05-1043
Rough, spiral end
14 cm



05-1044
Rough, spiral end
14 cm



FARRELL
05-1045
Round,
serrated end
14 cm



LATHBURY-FARRELL
05-1046
Triangular,
serrated end
14 cm



FARRELL
05-1047
Rough, spiral end
16 cm



LATHBURY-FARRELL
05-1048
Triangular, serrated end
16 cm



05-1049
Triangular,
serrated end
16 cm



05-1050
Rough, spiral end
18 cm



05-1051
Rough, spiral end
18 cm



05-1052
Rough, spiral end
27 cm

Clip Applying Forceps - Suture Set



½

MICHEL
05-1053
12.5 cm



½

HEGENBARTH
05-1054
12 cm



½

WACHENFELDT
05-1055
12 cm



½

WACHENFELDT
05-1056
12 cm



½

MICHEL
05-1057
12.5 cm



½

MICHEL modif.
05-1058
13 cm



½

HEATH
05-1059
13.5 cm



½

COLLIN
05-1060
13.5 cm

Page 103-159



- Fine Wound Retractors (dura & Skin Retractors)
- Wound - Trachea Retractors
- Retractors With Triangular Handle
- Retractors
- Saddle Hooks & Vein Hooks
- Bone Retractors
- Retractors, Deep Form
- Aorta Retractors
- Retractors For Deep Surgery
- Spatulas Retractors
- Lung Spatulas
- Atrium Retractors
- Retractors For Deep Surgery (abdominal Retractors)
- Abdominal Retractors
- Pelvis Retractors
- Abdominal & Intestinal Spatulas
- Hooklets
- Wound Spreaders, Self-Retaining
- Self-Retaining Retractors
- Self-Retaining Laminectomy Retractors
- Special Retractors
- Self-Retaining Retractors For Laminectomy & Other Operations
- Retractors For Cervical Spine
- Self-Retaining & Abdominal Retractors



Fine Wound Retractors (dura- And Skin Retractors)

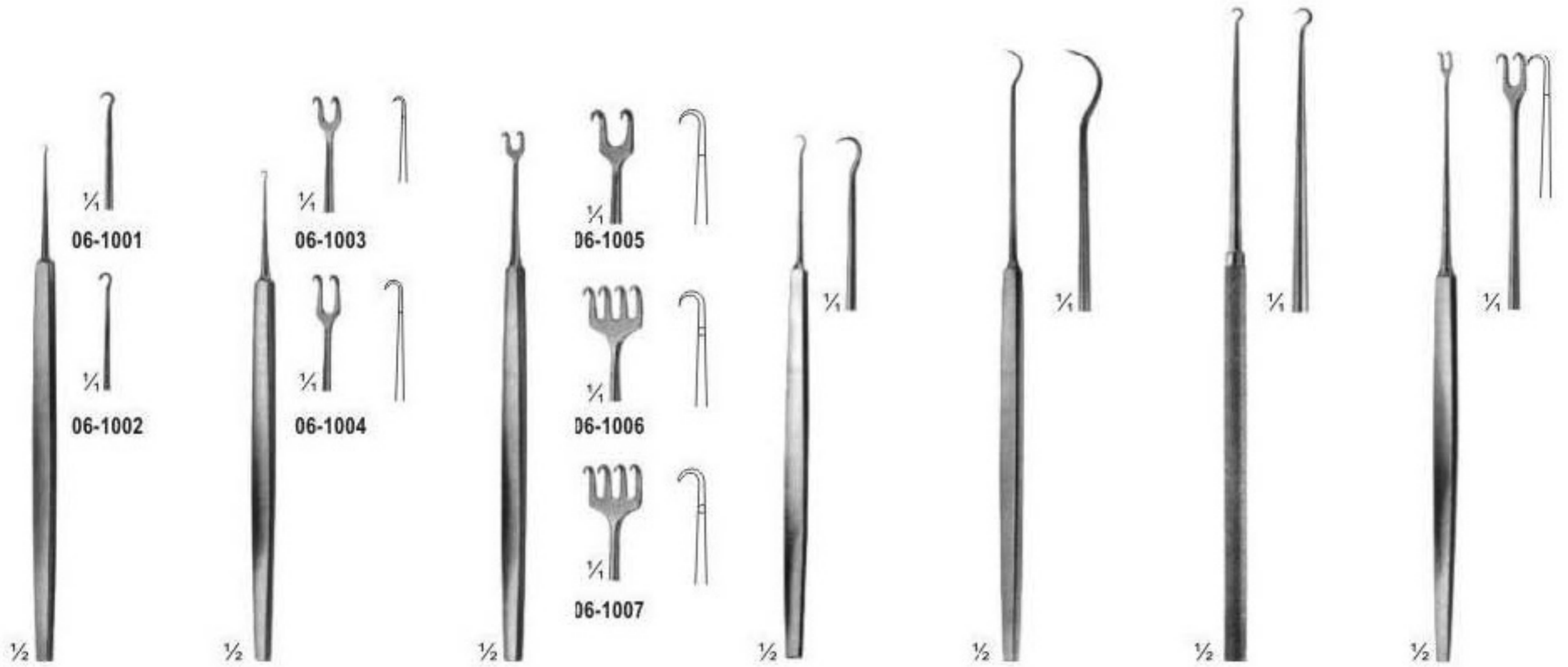

GRAEFE
06-1001 Sharp
06-1002 Blunt
12.5 cm

GUTHRIE
06-1003 12.5 cm
06-1004 13 cm
Sharp

ROLLET
06-1005 13 cm
06-1006 13.5 cm
Sharp
06-1007 13.5 cm
Blunt

FRAZIER
Dura Retractors
06-1008
13 cm

TONNIS
Dura Retractors
06-1009
15 cm

KILNER
06-1010
16 cm

FREER
06-1011
15 cm

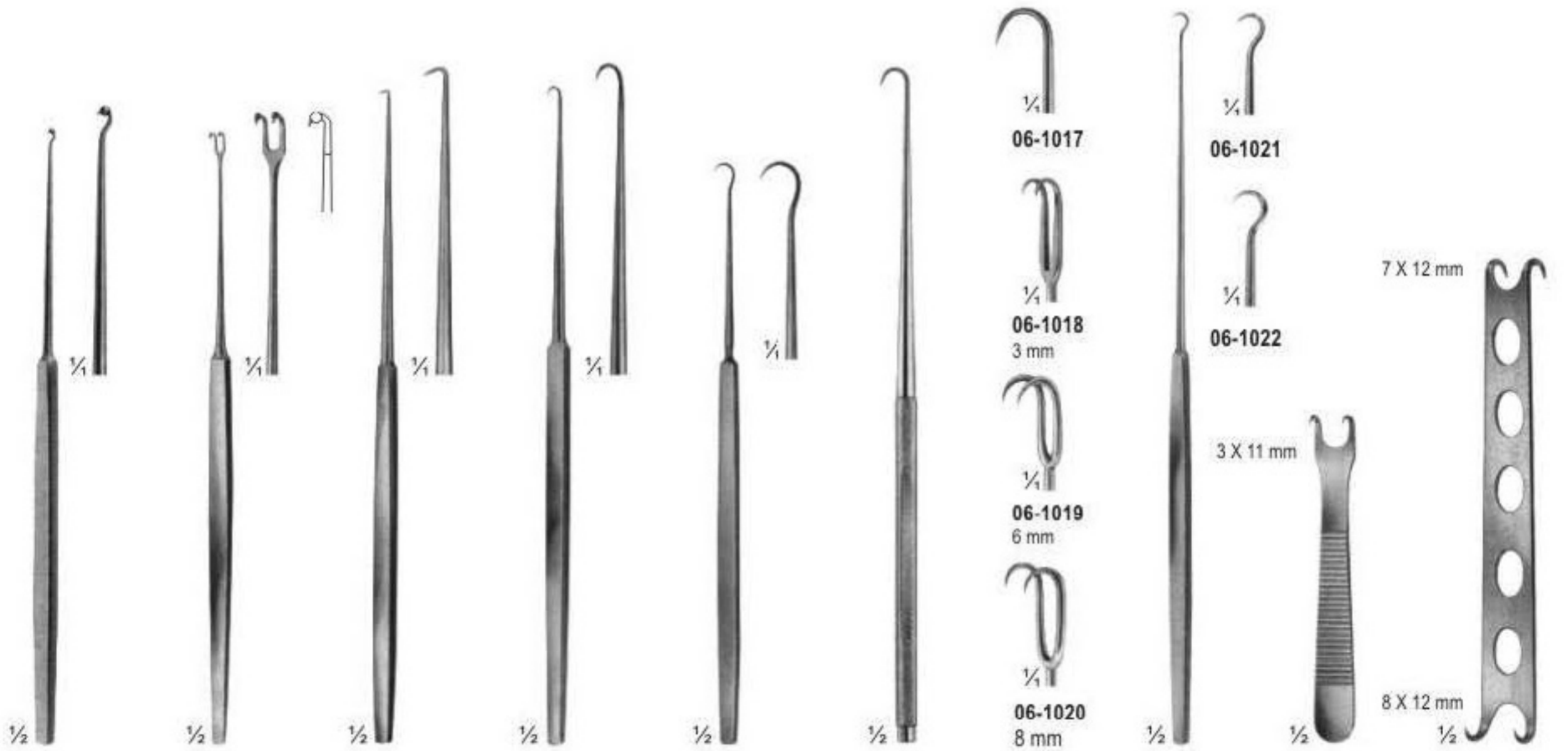

MULLER
06-1012
15 cm

MULLER
06-1013
15 cm

COTTLE
06-1014
16 cm

COTTLE
06-1015
16 cm

JAEGAR
06-1016
13.5 cm

JOSEPH
06-1017 - 06-1020
16.5 cm

GILLIES
06-1021 - 06-1022
18 cm

KILNER
Sharp
06-1023
8 cm

CONVERSE
Blunt
06-1024
12 cm

Retractors



EMMET
Fistula hook
06-1025
22 cm



SIMON
Fistula hook
06-1026
22 cm

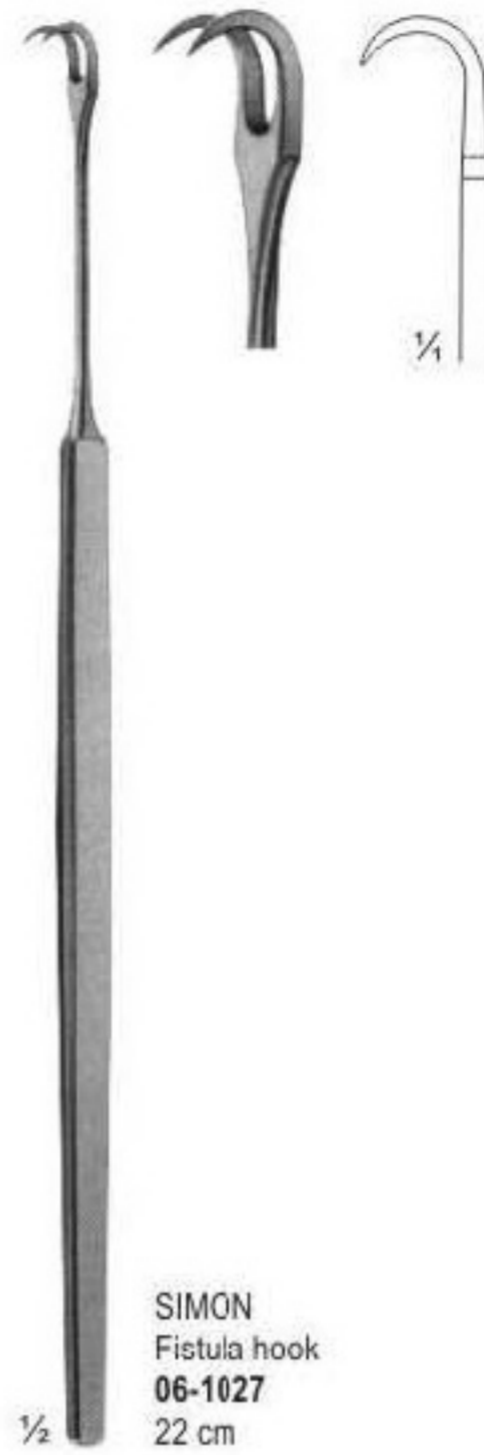

SIMON
Fistula hook
06-1027
22 cm



LANGE
Fistula hook
06-1028
23 cm

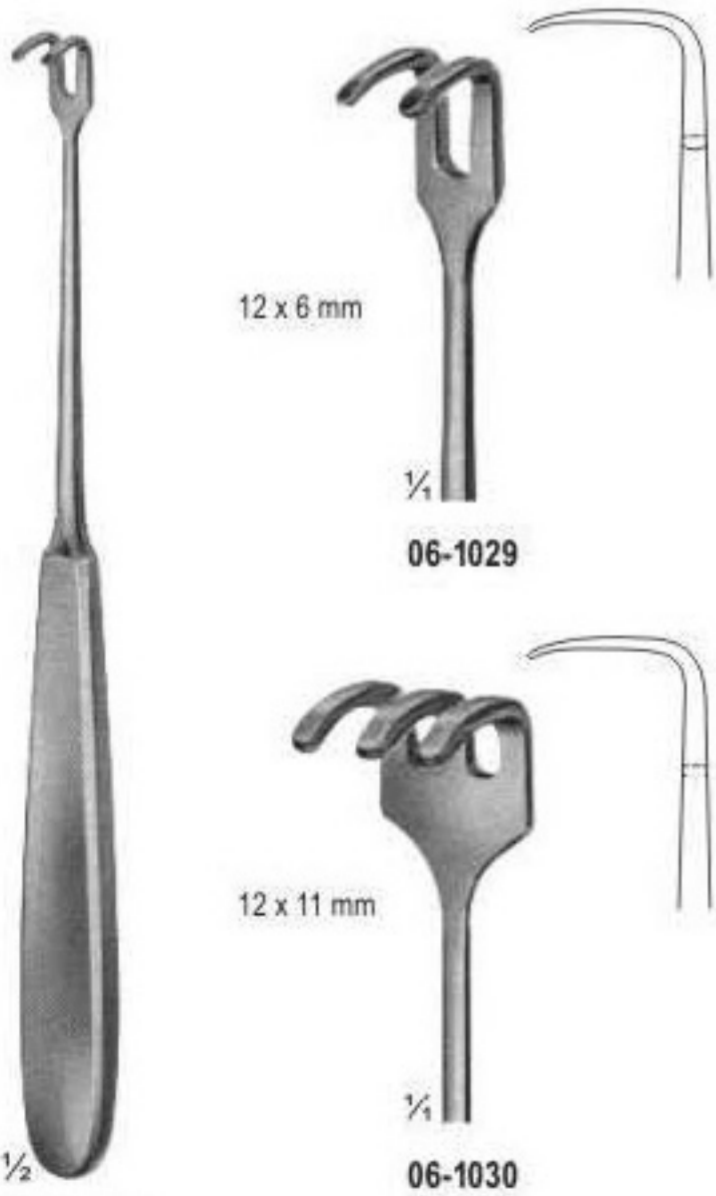

Tendon hooks
06-1029 - 06-1030
17.5 cm

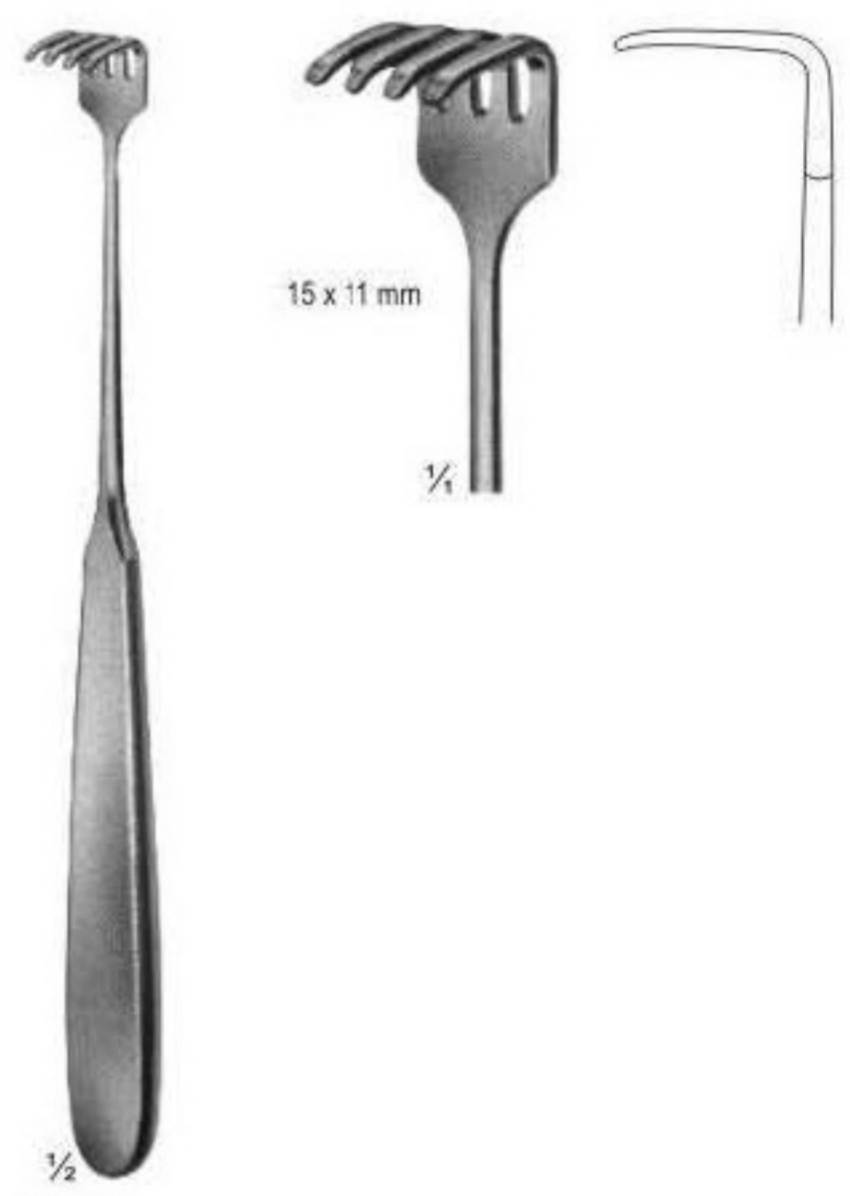

KLAPP
Tendon hooks
06-1031
17.5 cm

Retractors With Triangular Handle

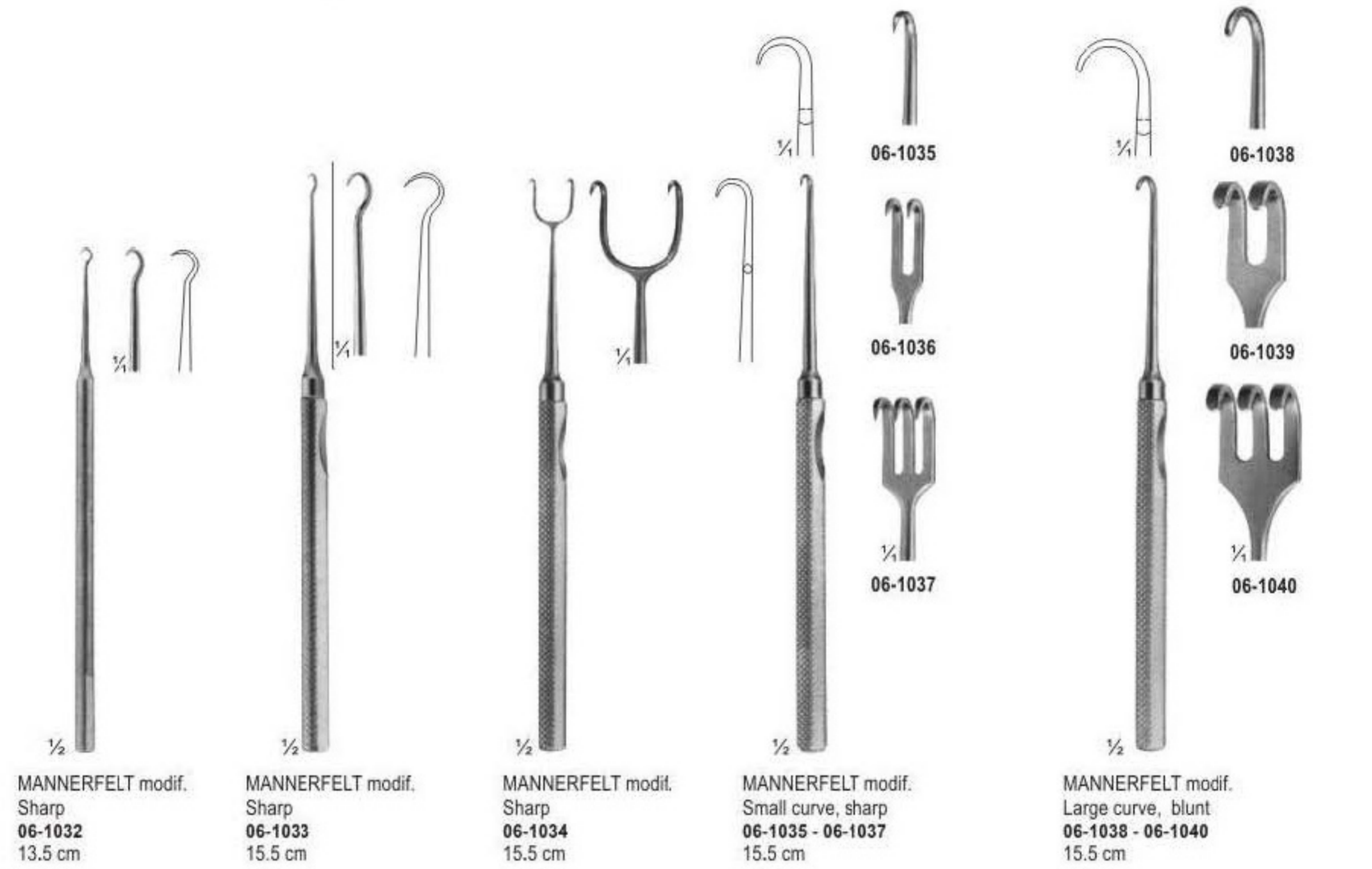

Wound - Trachea Retractors



BERGMANN
06-1049
14 cm



06-1050 - 06-1051
18 cm



06-1050
Sharp



06-1051
Blunt



06-126-18
Blunt



1/4



06-1052 - 06-1054
Flexible shaft, sharp
15.5 cm



06-1052



06-1053



06-1054



06-1055 - 06-1057
Flexible shaft, blunt
15.5 cm



06-1055



06-1056



06-1057



06-1058 - 06-1065
Large curve,
sharp
16.5 cm



06-1058



06-1060



06-1062



06-1064



06-1059



06-1061



06-1063



06-1065



06-1066 - 06-1073
Large curve,
blunt
16.5 cm



06-1066



06-1068



06-1070



06-1072



06-1067



06-1069



06-1071



06-1073

Retractors



06-1074
16 x 6 mm

06-1075
24 x 6 mm

LANGENBECK-GREEN
06-1074 - 06-1075
16 cm



10 x 13 mm

06-1076
16 cm



06-1077

06-1078

06-1077 - 06-1078
16 cm



FOMON
06-1079
14.5 cm

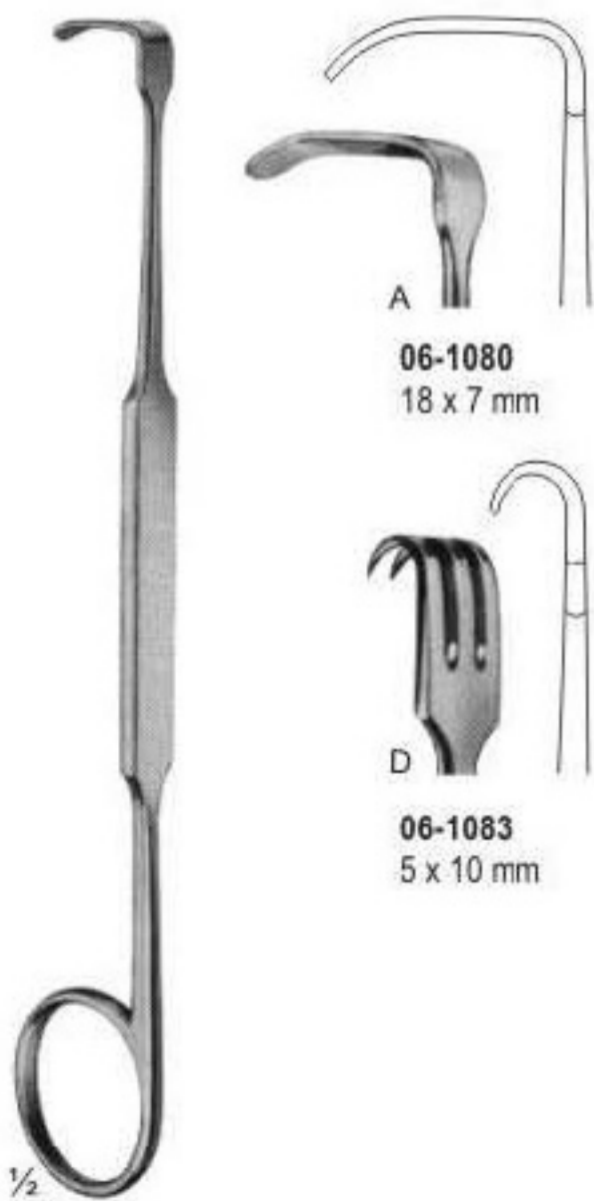

A
06-1080
18 x 7 mm

D
06-1083
5 x 10 mm



B
06-1081
16 x 5 mm



E
06-1084
11 x 4 mm



C
06-1082
7 x 4 mm



F
06-1085
6 x 4 mm

MEYERDING
Fig. A - Fig. F
06-1080 - 06-1085
18 cm

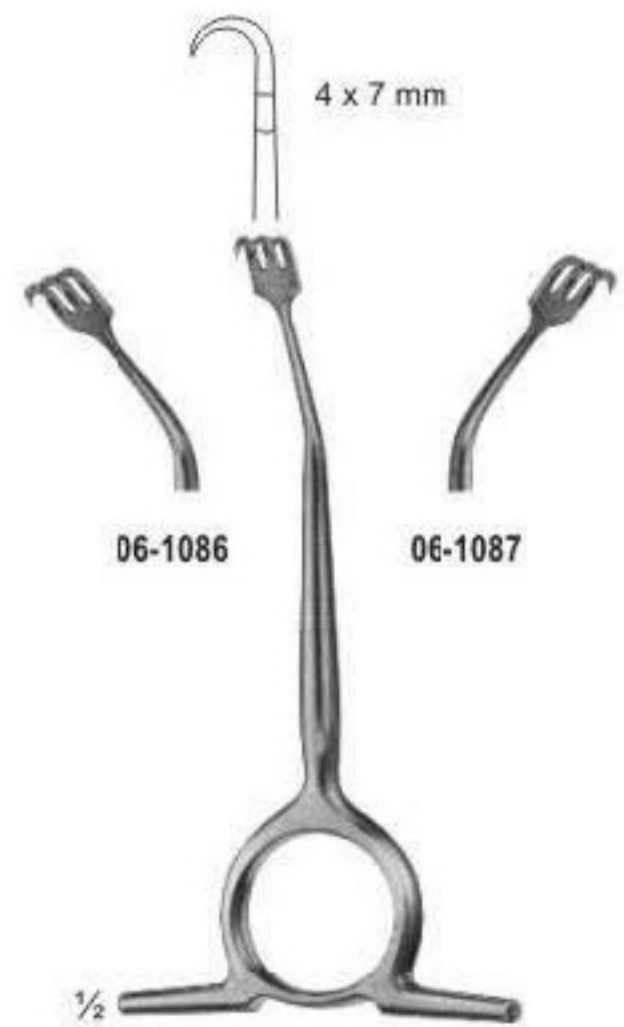

4 x 7 mm

06-1086

06-1087

WILLIGER
06-1086 - 06-1087
12 cm

Retractors



Saddle Hooks, Vein Hooks and Retractors



GILL-VERNET
06-1107 - 06-1114
Malleable Shaft
24 cm



06-1107
4 mm



06-1108
6 mm



06-1109
8 mm



06-1110
11 mm



06-1111
15 mm



06-1112
17 mm



06-1113
20 mm



06-1114
23 mm



STANDELL-STILLE
06-1115 - 06-1116
19 cm

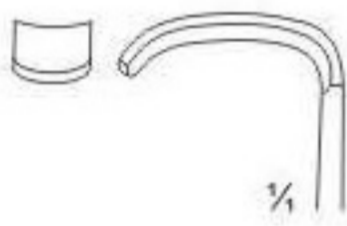

Fig. 1
06-1115
Smooth Blade End

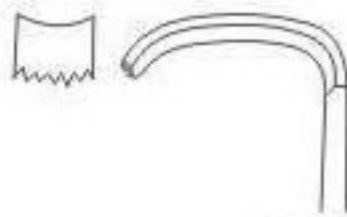
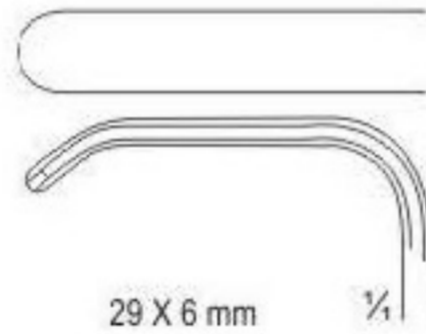

Fig. 2
06-1116
Toothed Blade End



LAHEY
06-1117
19.5 cm



29 X 6 mm



LITTLE
06-1118
20.5 cm

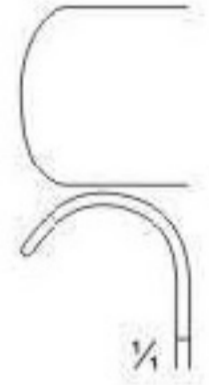

13 X 15 mm

Bone Retractors



½
KOCHER
Sharp
06-1119
20.5 cm



½
KOCHER
Sharp
06-1120
22 cm



½
KOCHER
Blunt
06-1121
22 cm



½
VOLKMANN
Sharp
06-1122
22 cm



½
VOLKMANN
Sharp
06-1123
22 cm



½
VOLKMANN
06-1124 - 06-1131
22.5 cm

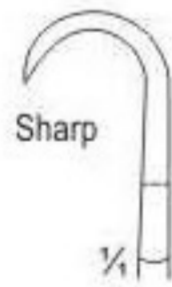

Sharp

¼

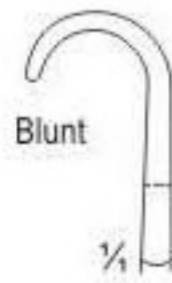

Blunt

¼



06-1124
9 x 8 mm



06-1125
9 x 13 mm



06-1126
9 x 19 mm



06-1127
9 x 29 mm



06-1128
8.5 x 8 mm



06-1129
8.5 x 13 mm



06-1130
8.5 x 19 mm



06-1131
8.5 x 29 mm

Retractors, Deep Form



KORTE
06-1132 - 06-1133
24 cm



06-1132
8 Prongs, blunt



06-1133
8 Prongs, sharp



ISRAEL
06-1134 - 06-1137
25.5 cm

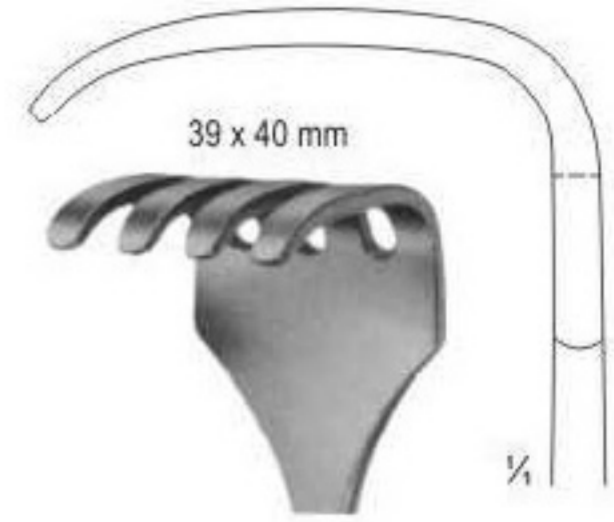

06-1134
4 Prongs, blunt

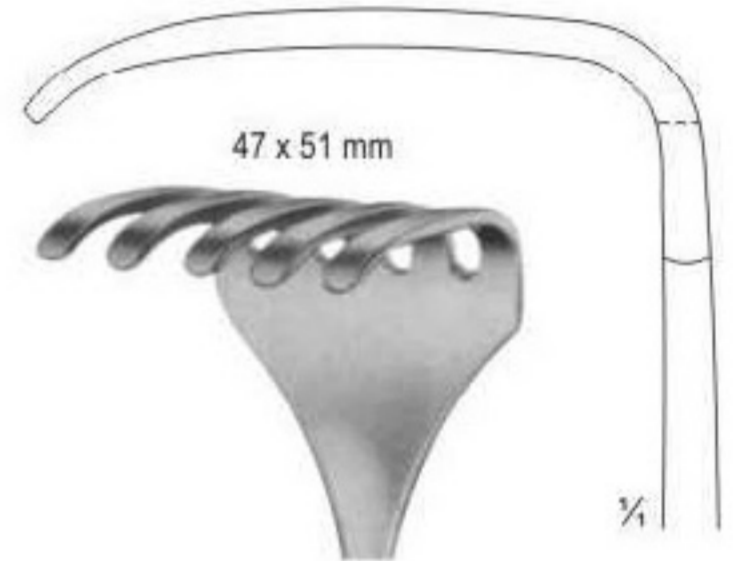

06-1135
5 Prongs, blunt

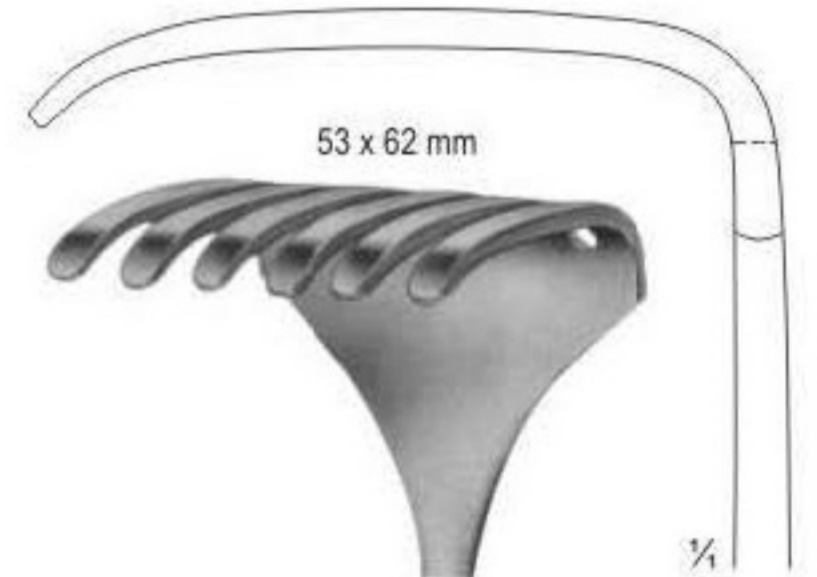

06-1136
6 Prongs, blunt

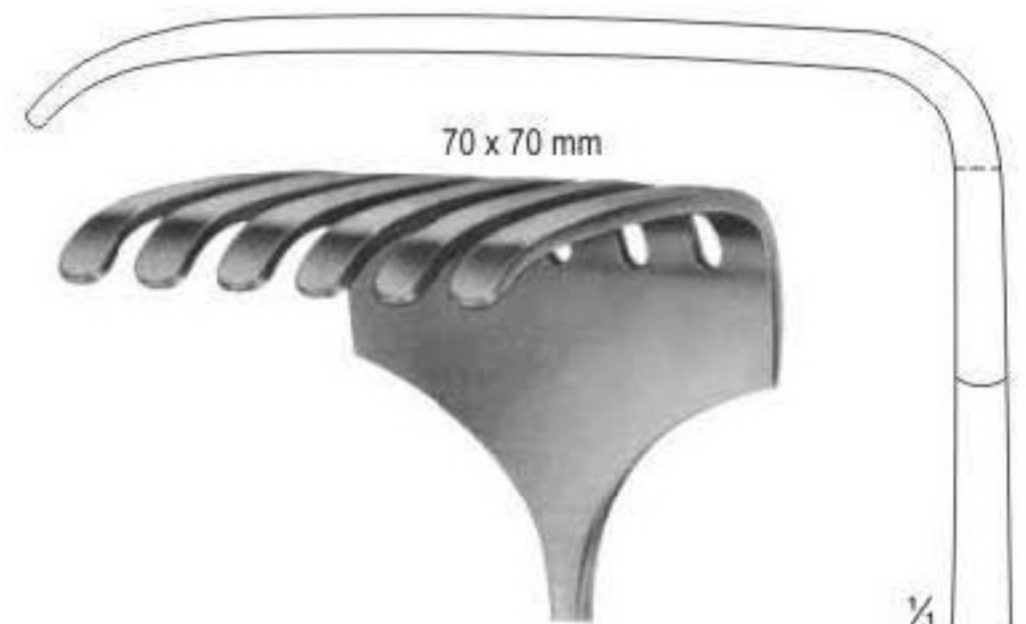

06-1137
6 Prongs, blunt

Retractors



VOLKMANN
06-1138 - 06-1151
22 cm

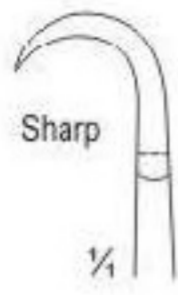

06-1138
9 x 8 mm



06-1139
9 x 13 mm



06-1140
9 x 19 mm



06-1141
9 x 29 mm



06-1142
9 x 40 mm

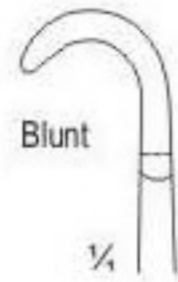

06-1143
8 x 8 mm



06-1144
8 x 13 mm



06-1145
8 x 19 mm



06-1146
8 x 29 mm



06-1147
8 x 40 mm



06-1148
8.5 x 8 mm



06-1149
8.5 x 13 mm



06-1150
8.5 x 19 mm



06-1151
8.5 x 29 mm



KOCHER
06-1152 - 06-1159
22 cm

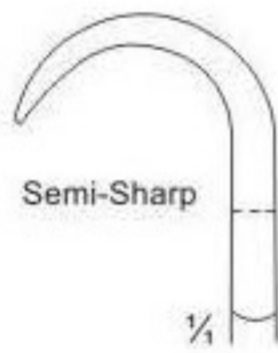

06-1152
16 x 9 mm



06-1153
16 x 14 mm



06-1154
16 x 20 mm



06-1155
16 x 30 mm

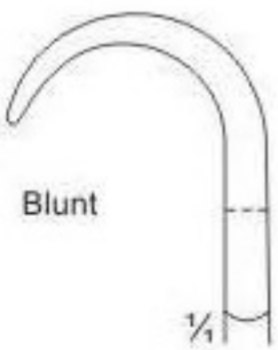

06-1156
15.5 x 9 mm



06-1157
15.5 x 14 mm



06-1158
15.5 x 20 mm



06-1159
15.5 x 30 mm

Retractors



ZENKER
06-1160 - 06-1165



MINI-ZENKER
06-1160
18 cm
10 X 3 mm



06-1161
25 cm
35 X 8 mm

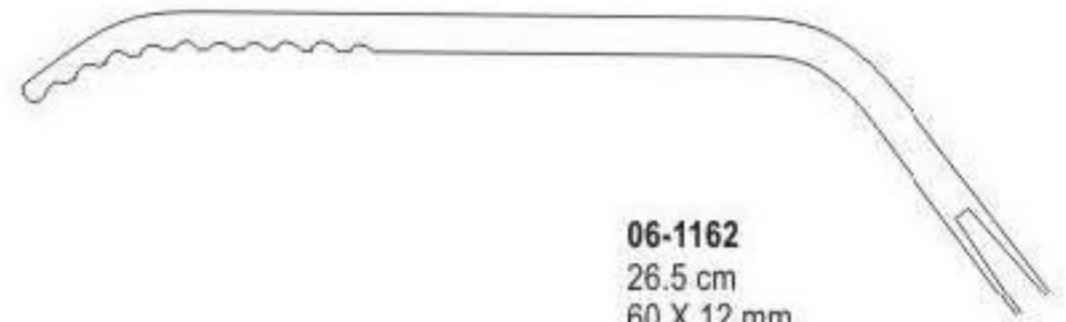

06-1162
26.5 cm
60 X 12 mm



06-1163
27.5 cm
75 X 12 mm



06-1164
28.5 cm
85 X 20 mm



06-1165
30.5 cm
100 X 25 mm

Retractors



KOCHER
06-1166 - 06-1170
23 cm



SAUERBRUCH
06-1171 - 06-1173
22.5 cm

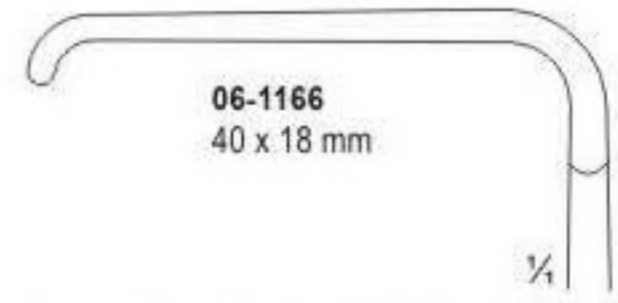

06-1166
40 x 18 mm



06-1167
60 x 20 mm



06-1168
60 x 25 mm

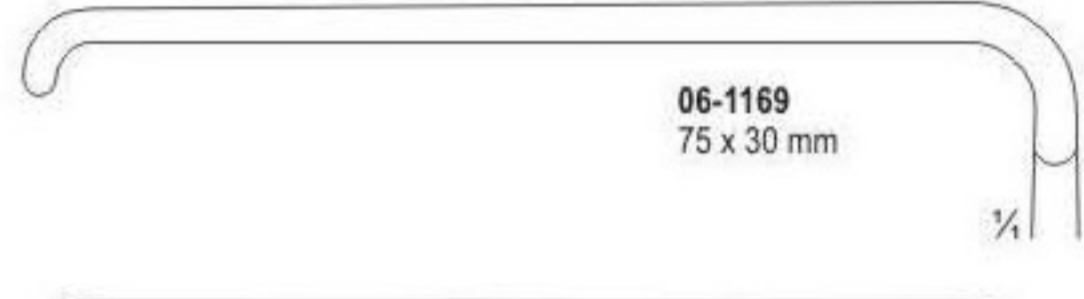

06-1169
75 x 30 mm



06-1170
75 x 40 mm

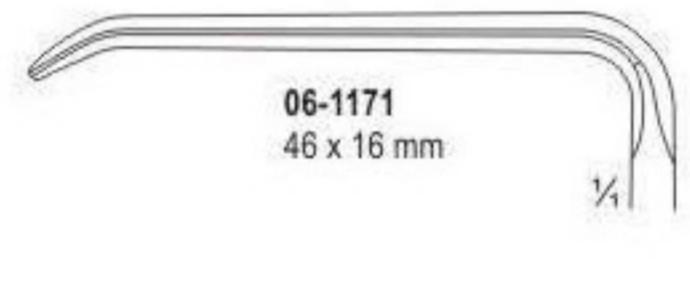

06-1171
46 x 16 mm

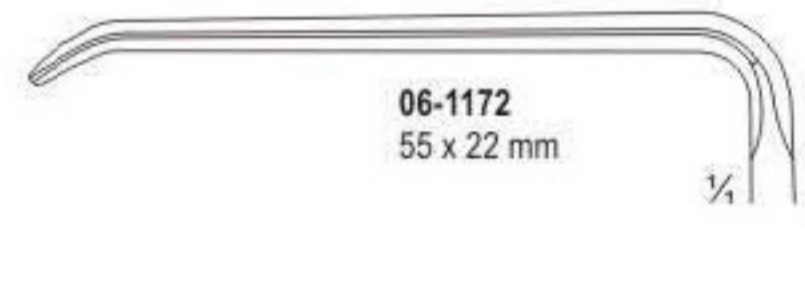

06-1172
55 x 22 mm

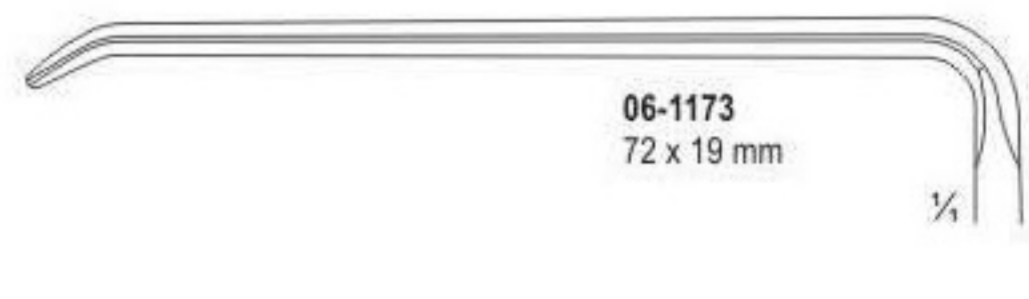

06-1173
72 x 19 mm

Retractors



LANGENBECK
06-1174 - 06-1179
21 cm
06-1174 28 x 10 mm
06-1175 28 x 14 mm
06-1176 33 x 14 mm
06-1177 28 x 16 mm
06-1178 40 x 10 mm
06-1179 40 x 13 mm



KOCHER-LANGENBECK
06-1180 - 06-1186
21.5 cm
06-1180 25 x 6 mm
06-1181 35 x 8 mm
06-1182 35 x 11 mm
06-1183 35 x 15 mm
06-1184 41 x 11 mm
06-1185 55 x 11 mm
06-1186 70 x 14 mm



LANGENBECK
06-1187
21.5 cm

Retractors



KOCHER
06-1188 - 06-1189
21.5 cm



¼

06-1188
20 X 12 mm



06-1189
23 X 14 mm



KOCHER
06-1190 - 06-1192



¼

06-1190
22 cm
40 X 10 mm



06-1191
23 cm
40 X 15 mm



06-1192
23 cm
40 X 20 mm

Retractors



MIDDELDORP[®]
06-1193 - 06-1195



06-1193
15 x 15 mm
22 cm



06-1194
20 x 22 mm
21.5 cm



06-1195
28 x 28 mm
23.5 cm

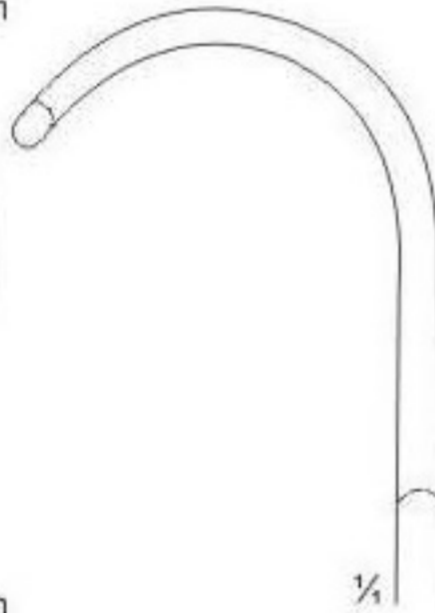
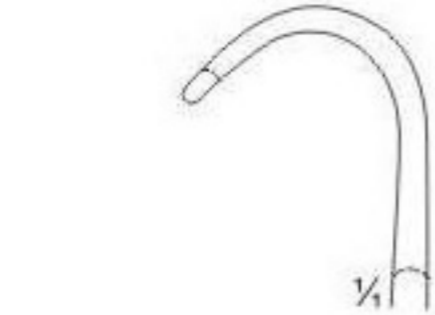

67 x 17 mm



CASPAR
06-1197
21 cm



36 x 20 mm

KOCHER
06-1198
23 cm



1/2

BUCHS
06-1196
20.5 cm



38 x 18 mm



06-1199
40 x 12 mm



06-1200
55 x 14 mm



DOCKHORN
06-1199 - 06-1200
20 cm

Retractors



HOSEL
06-1201 - 06-1206
25 cm

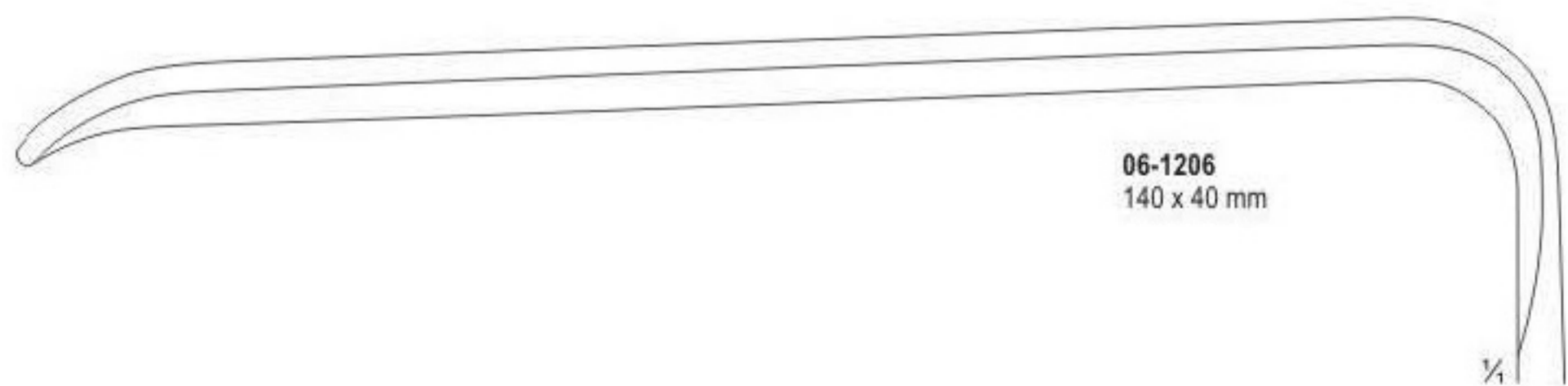
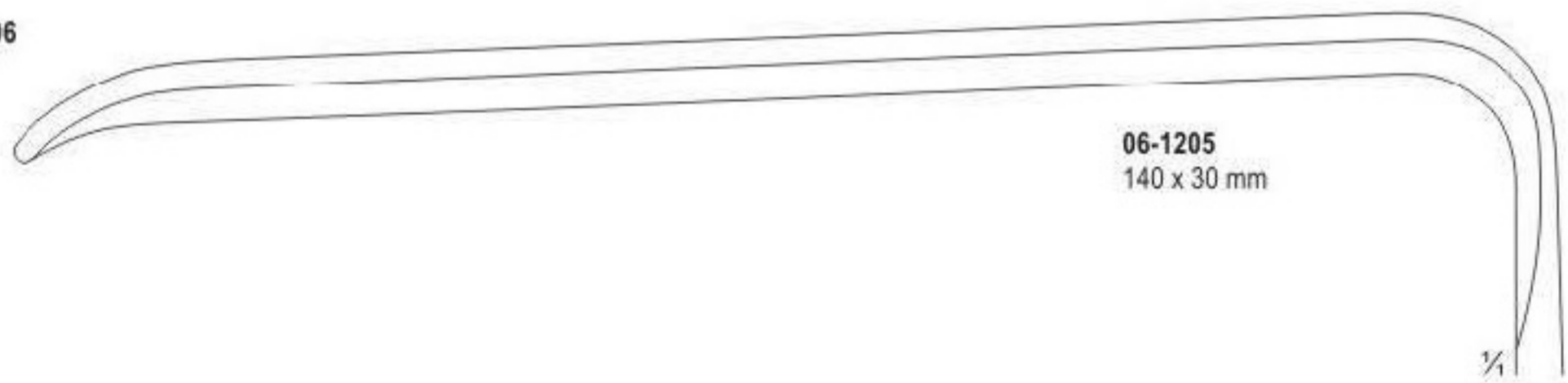
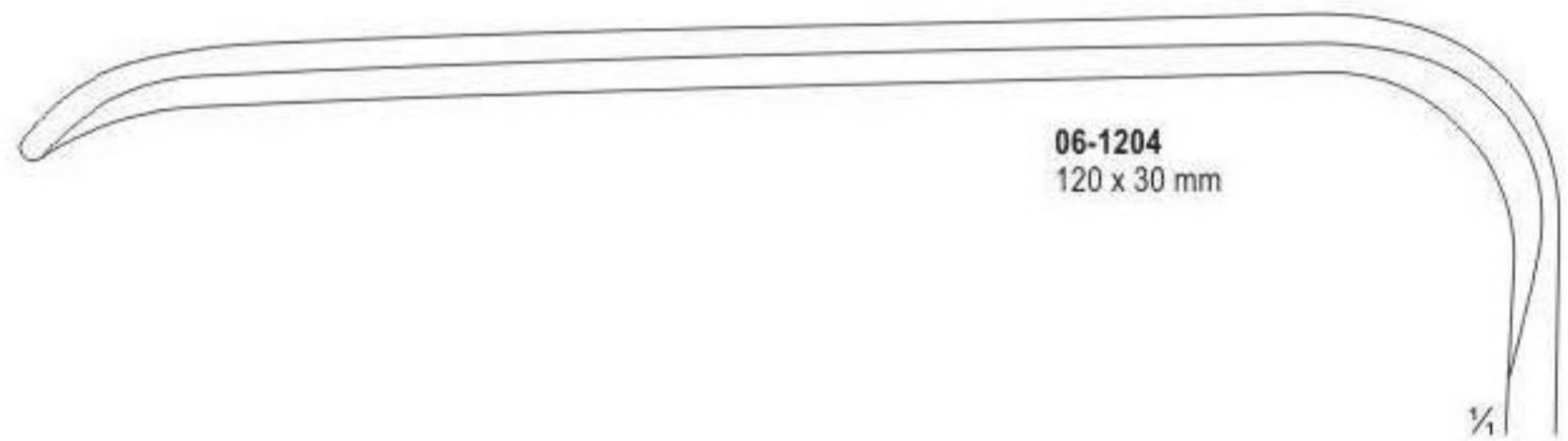
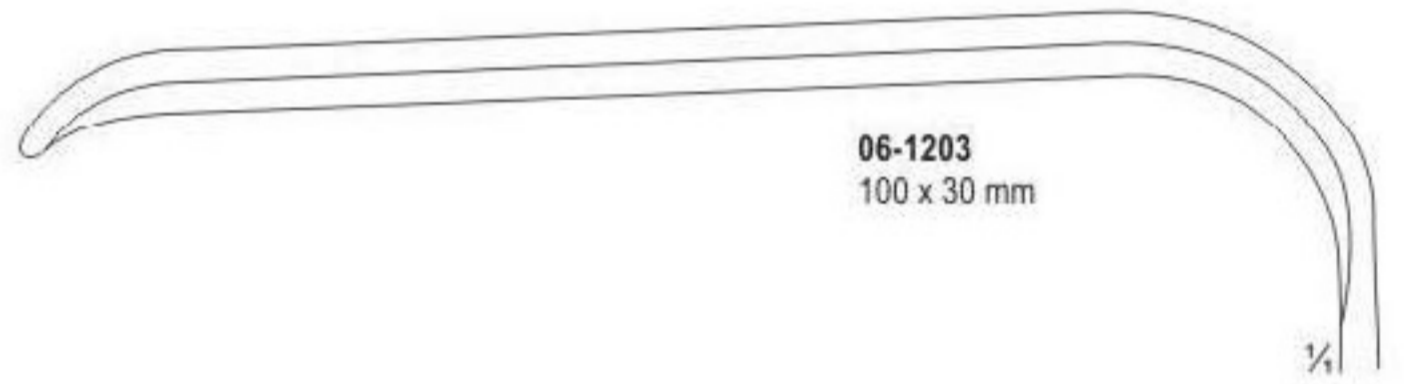
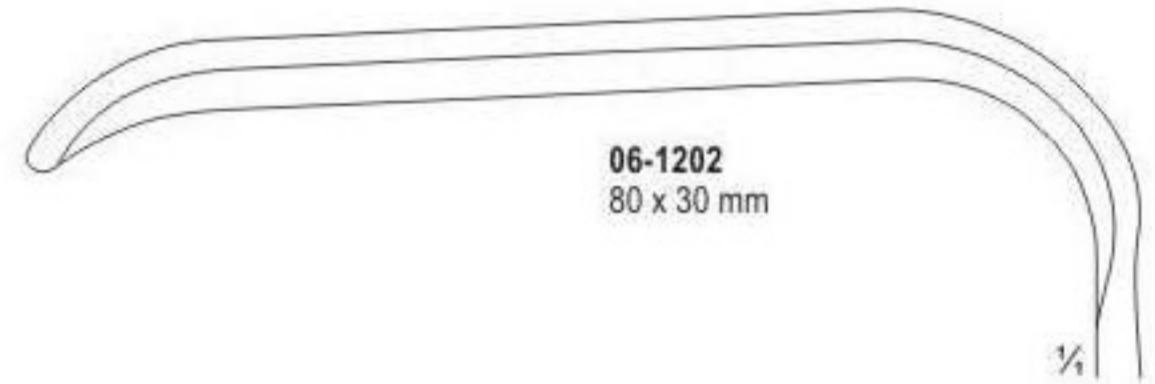
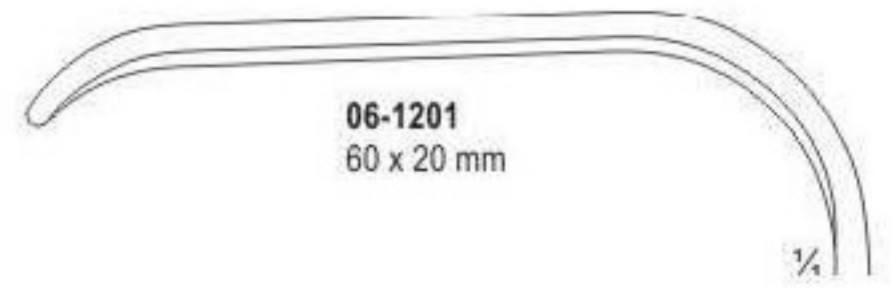

Retractors

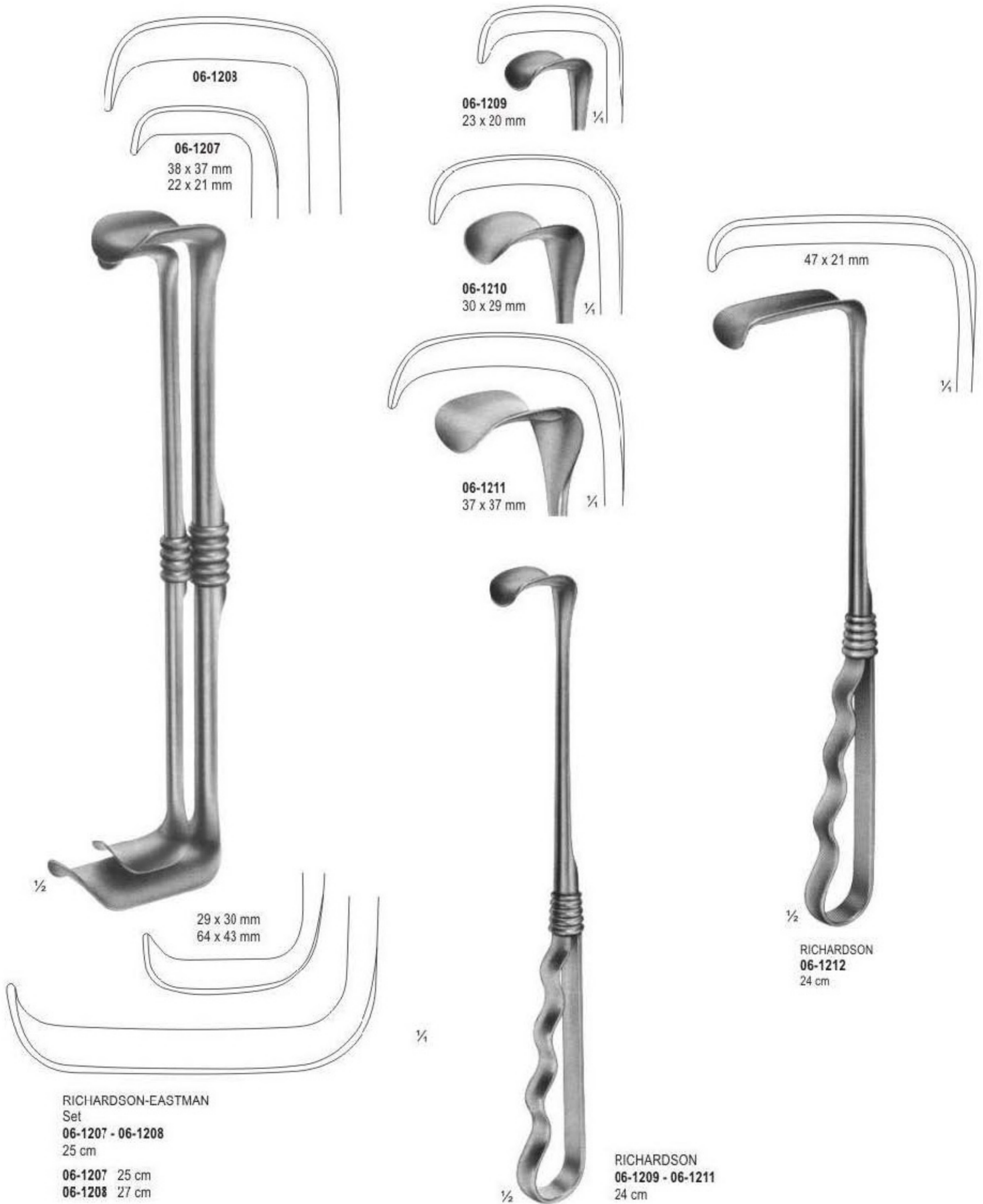

Retractors

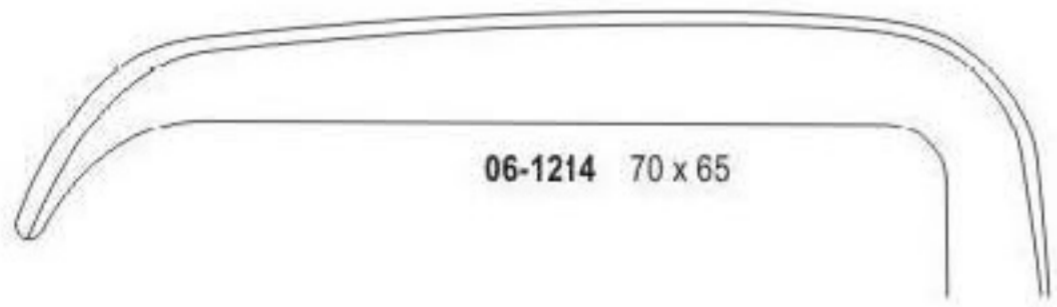

06-1214 70 x 65

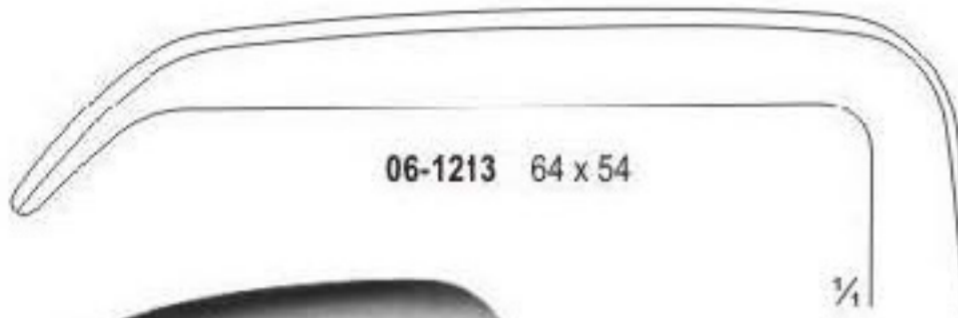

06-1213 64 x 54



1/2

KELLY
06-1213 - 06-1214
26 cm



06-1215 70 x 40
06-1216 70 x 50
06-1217 70 x 65

1/4



1/2

MORRIS
06-1215 - 06-1217
24.5 cm

Retractors



HÖSEL
06-1218 - 06-1223
26 cm

1/2

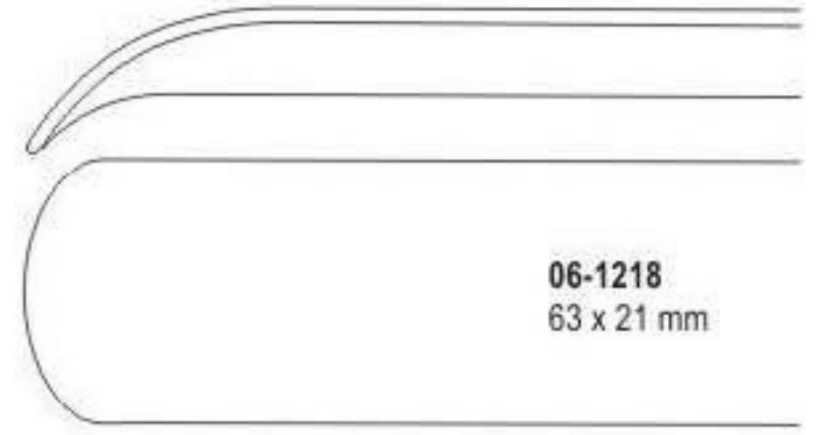

06-1218
63 x 21 mm



06-1219
83 x 30 mm



06-1220
103 x 30 mm



06-1221
120 x 30 mm



06-1222
140 x 30 mm



06-1223
140 x 40 mm

Retractors



HÖSEL
06-1218 - 06-1223
26 cm

1/2

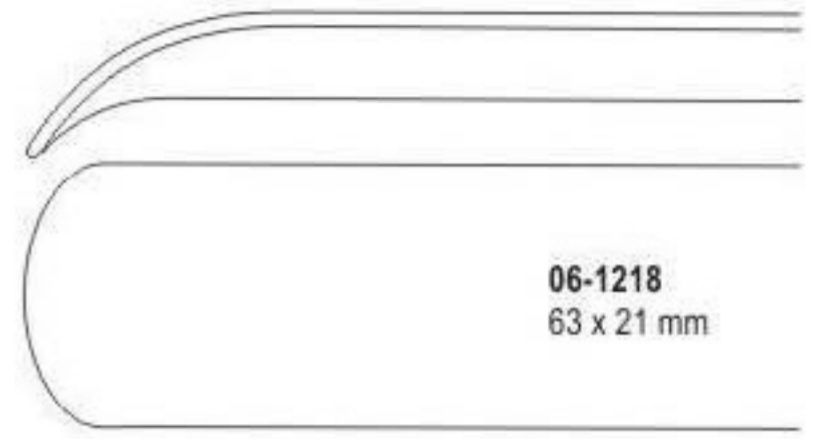

06-1218
63 x 21 mm



06-1219
83 x 30 mm



06-1220
103 x 30 mm



06-1221
120 x 30 mm



06-1222
140 x 30 mm



06-1223
140 x 40 mm

Spatulas Retractors

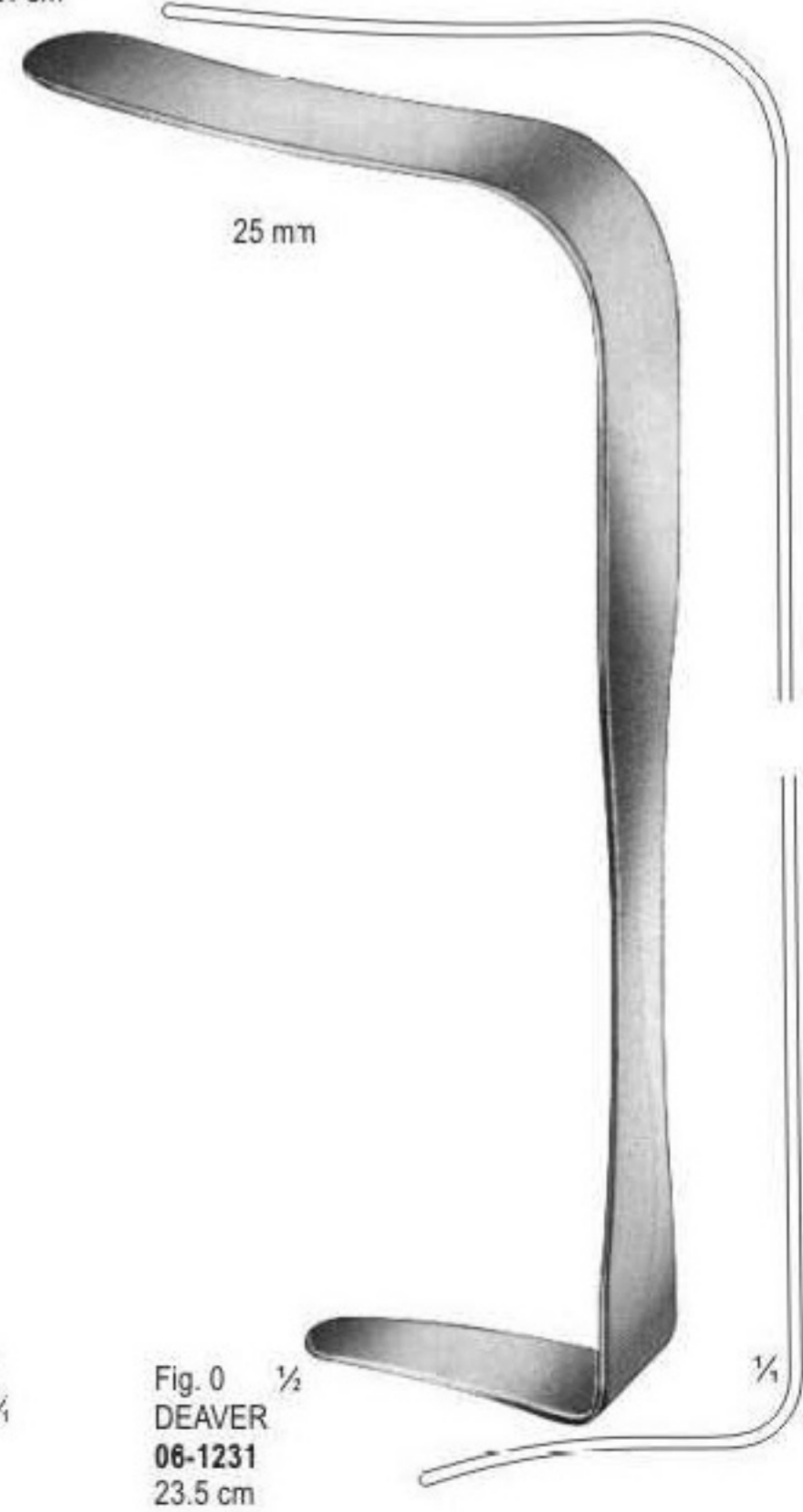
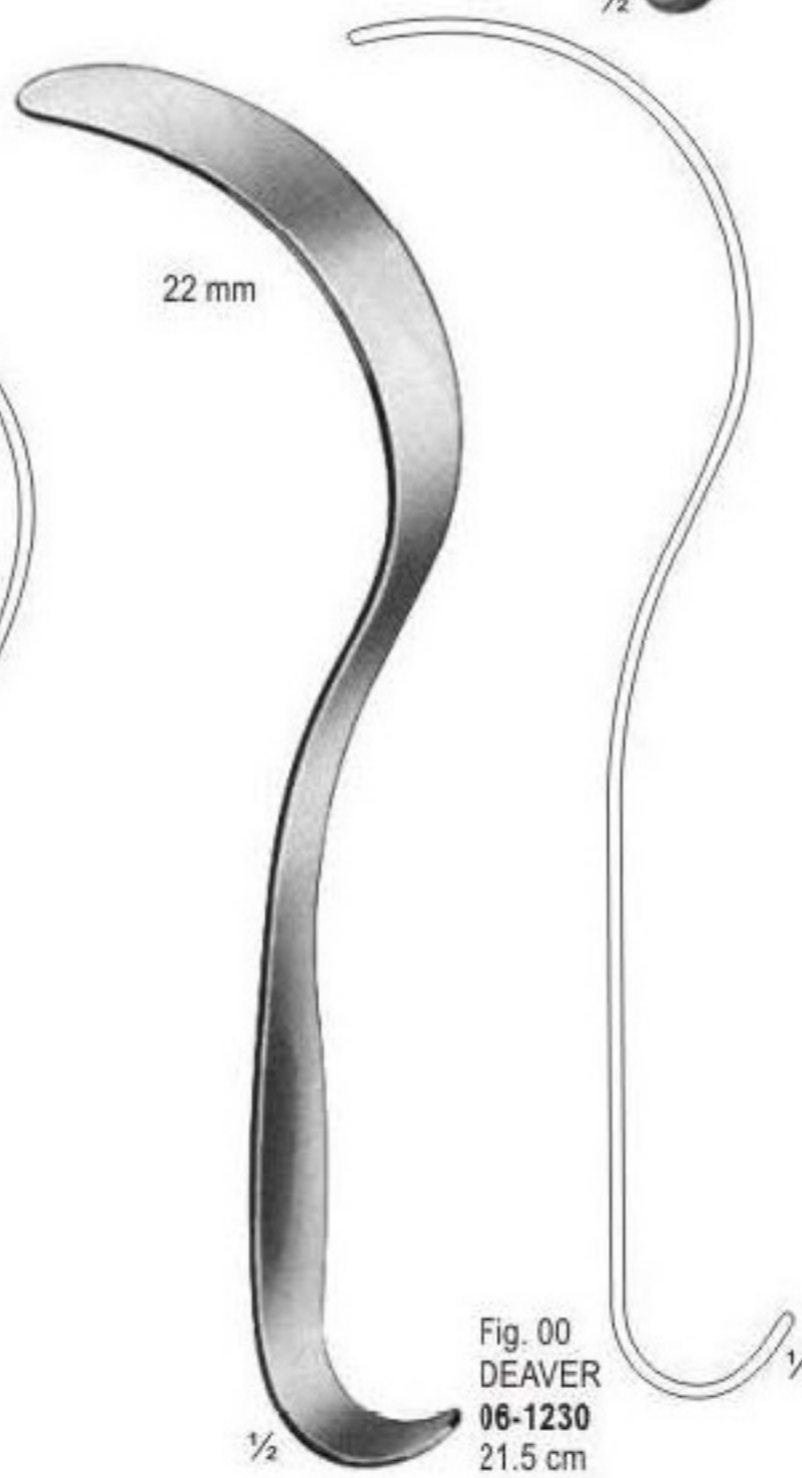
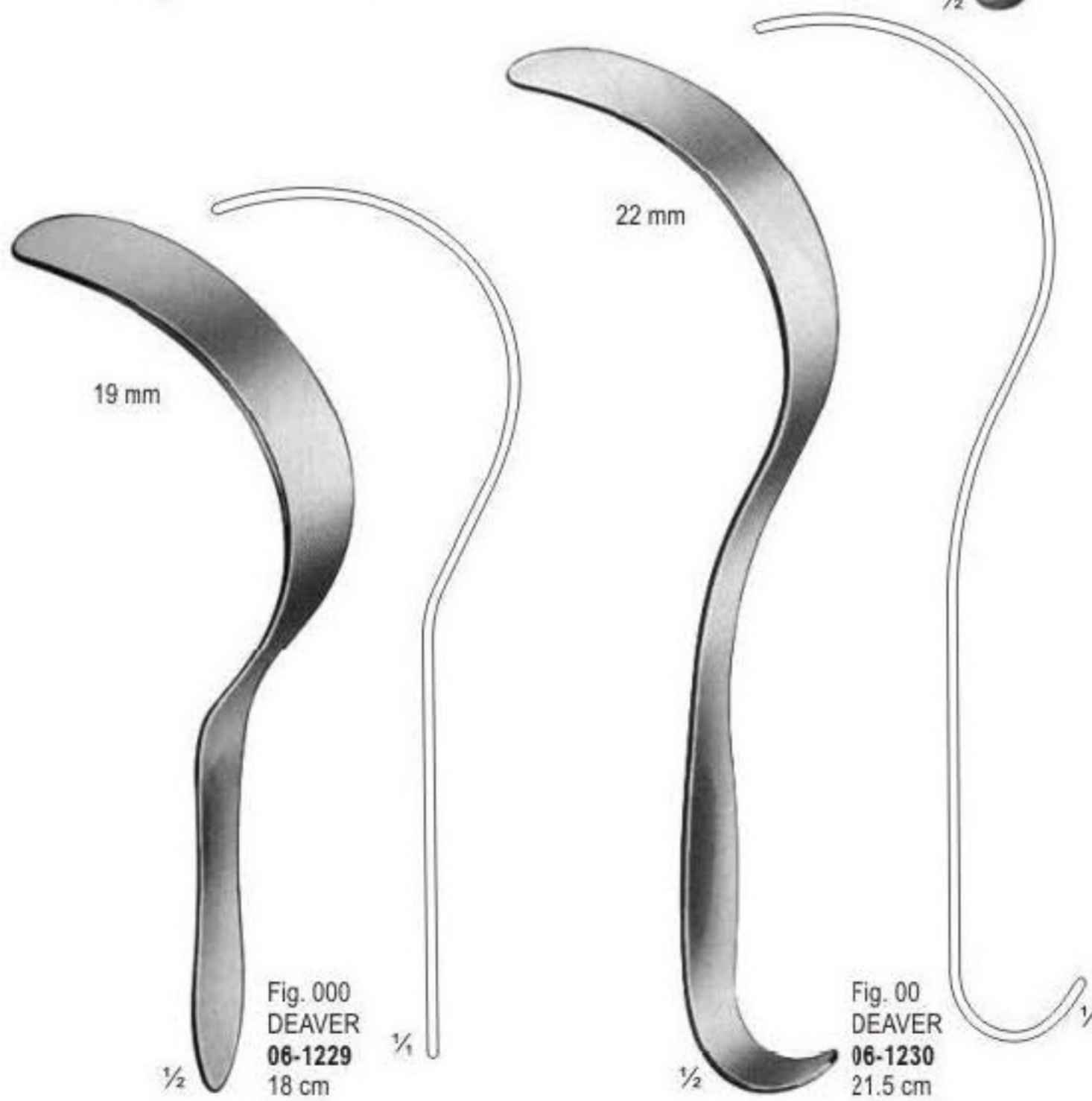
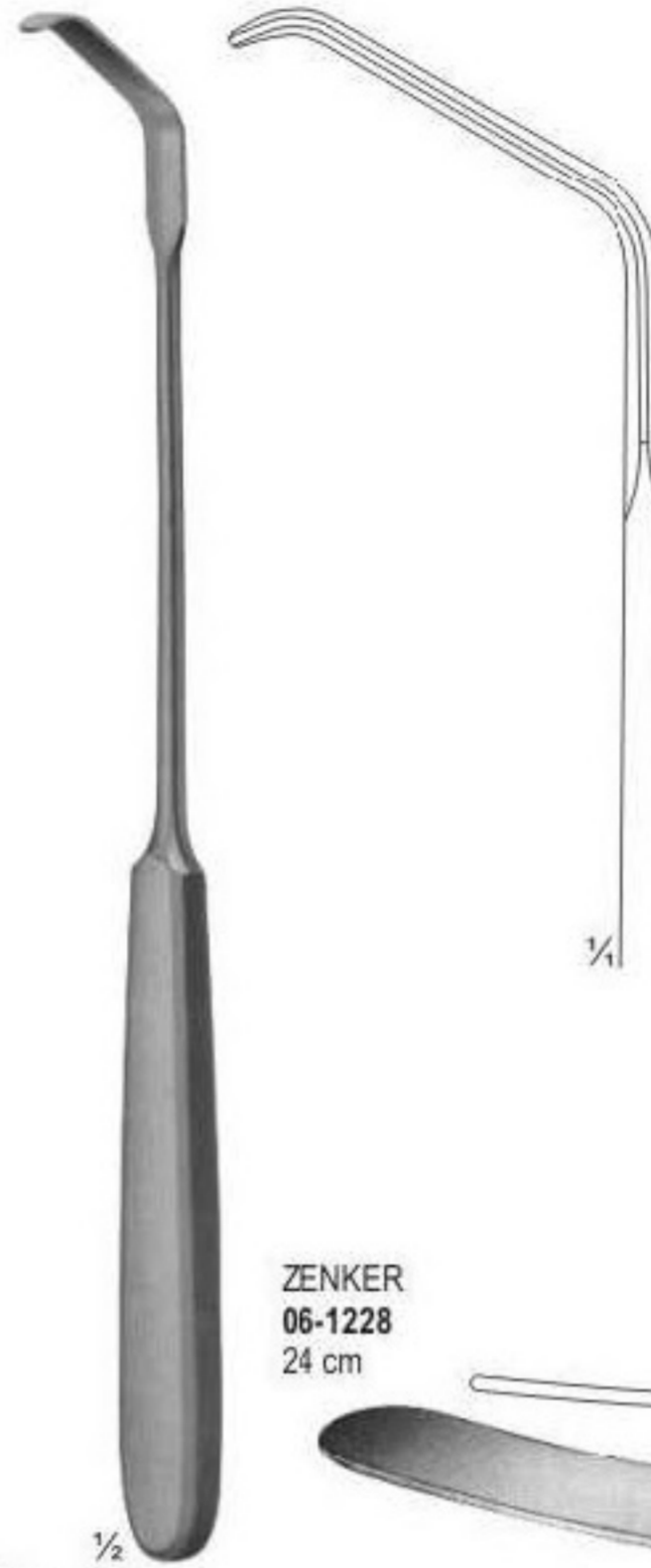
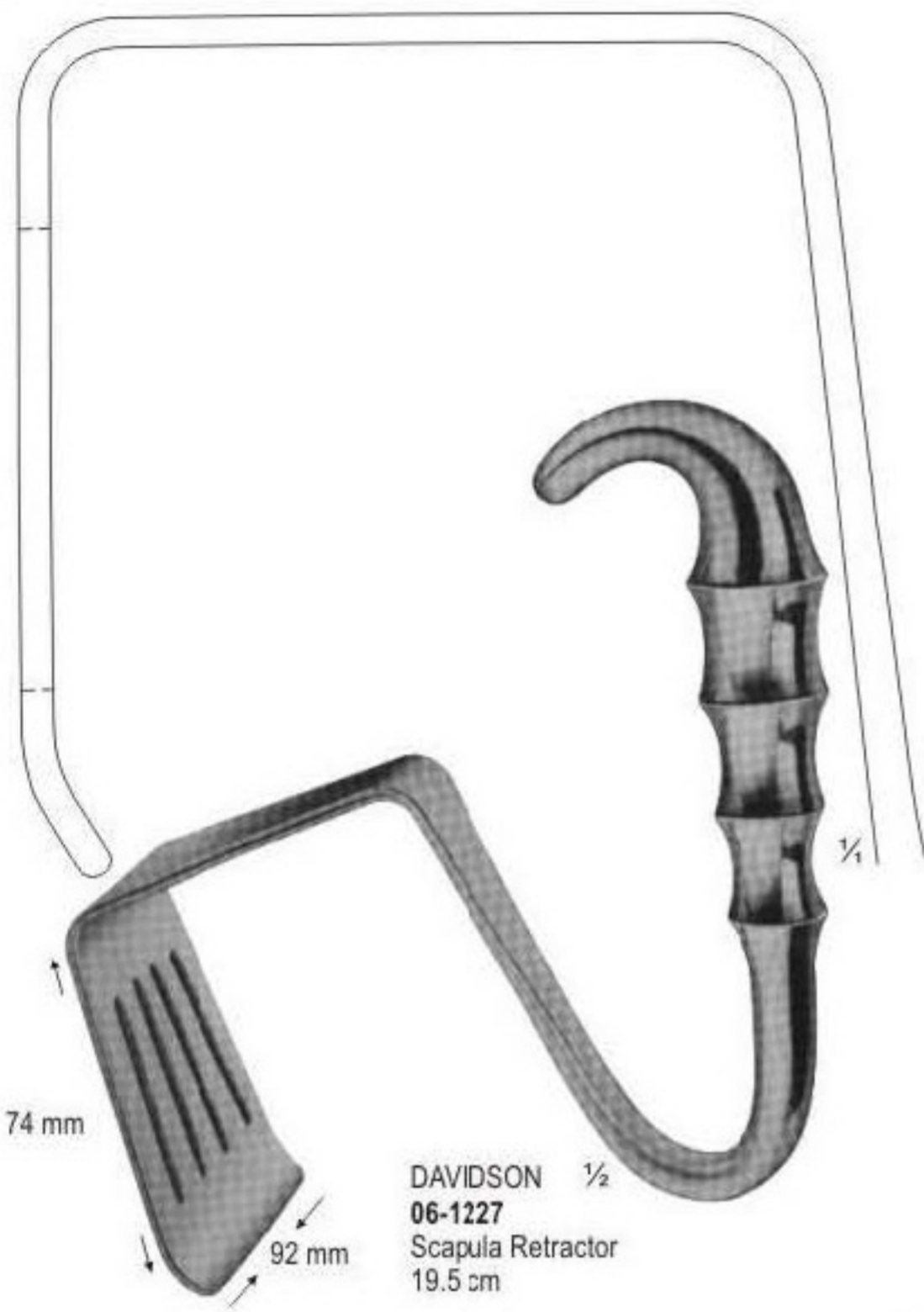

Retractors For Deep Surgery



Retractors For Deep Surgery

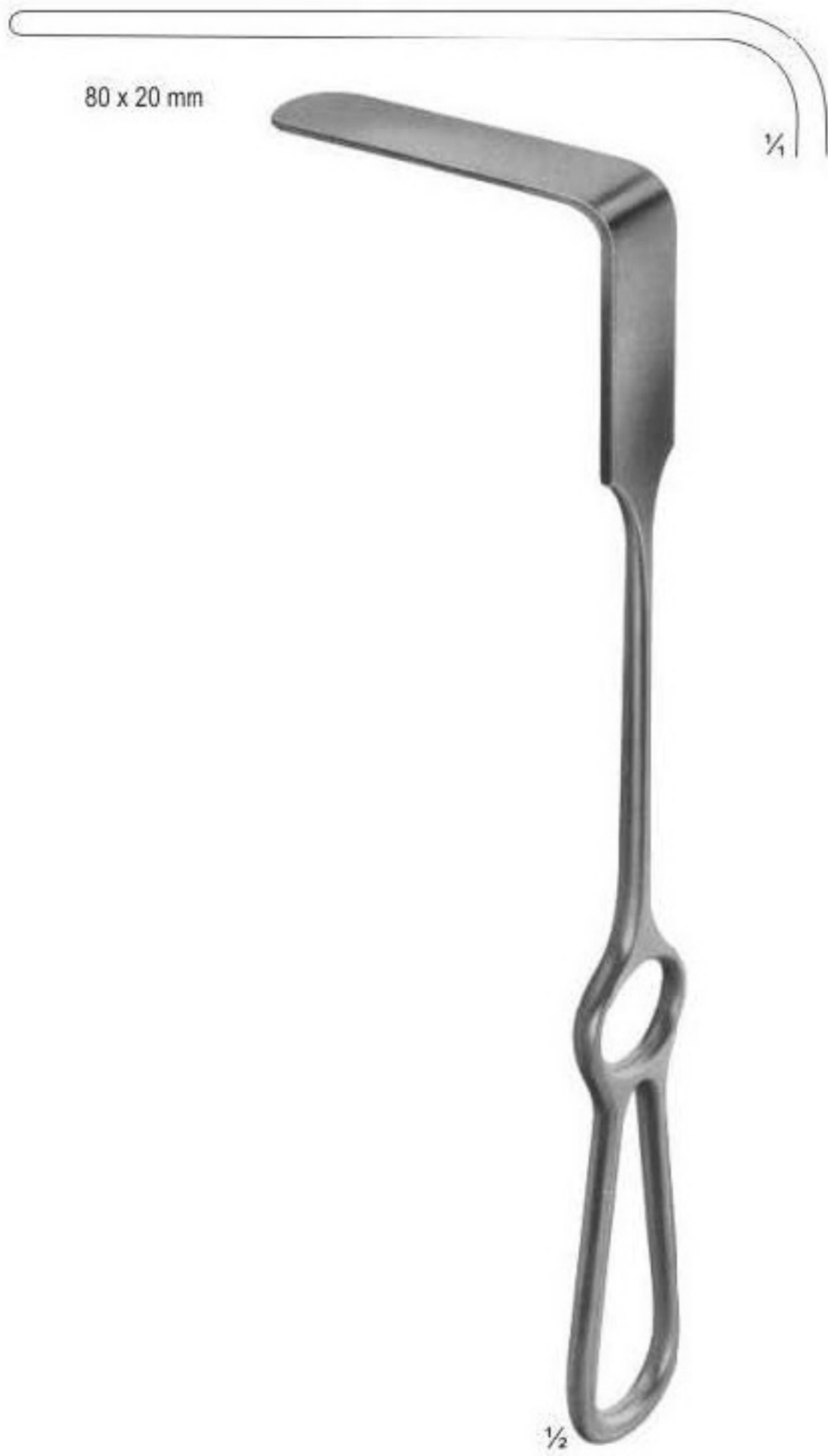

BRUNNER
06-1239 - 06-1245
27.5 cm

- 06-1239 80 x 20
- 06-1240 100 x 25
- 06-1241 120 x 25
- 06-1242 130 x 30
- 06-1243 140 x 30
- 06-1244 160 x 30
- 06-1245 180 x 30



06-1246
Handle with cold
light carrier for
retractor blades.
28 cm

Handle arrange-
ment variable

Aorta Retractors, Retractors



ROSS
06-1247 - 06-1252
Flexible Shaft



Fig. 1
06-1247
24 cm



Fig.
06-1248
24.5 cm



Fig. 3
06-1249
25 cm



Fig. 4
06-1250
25.5 cm



Fig. 5
06-1251
27 cm

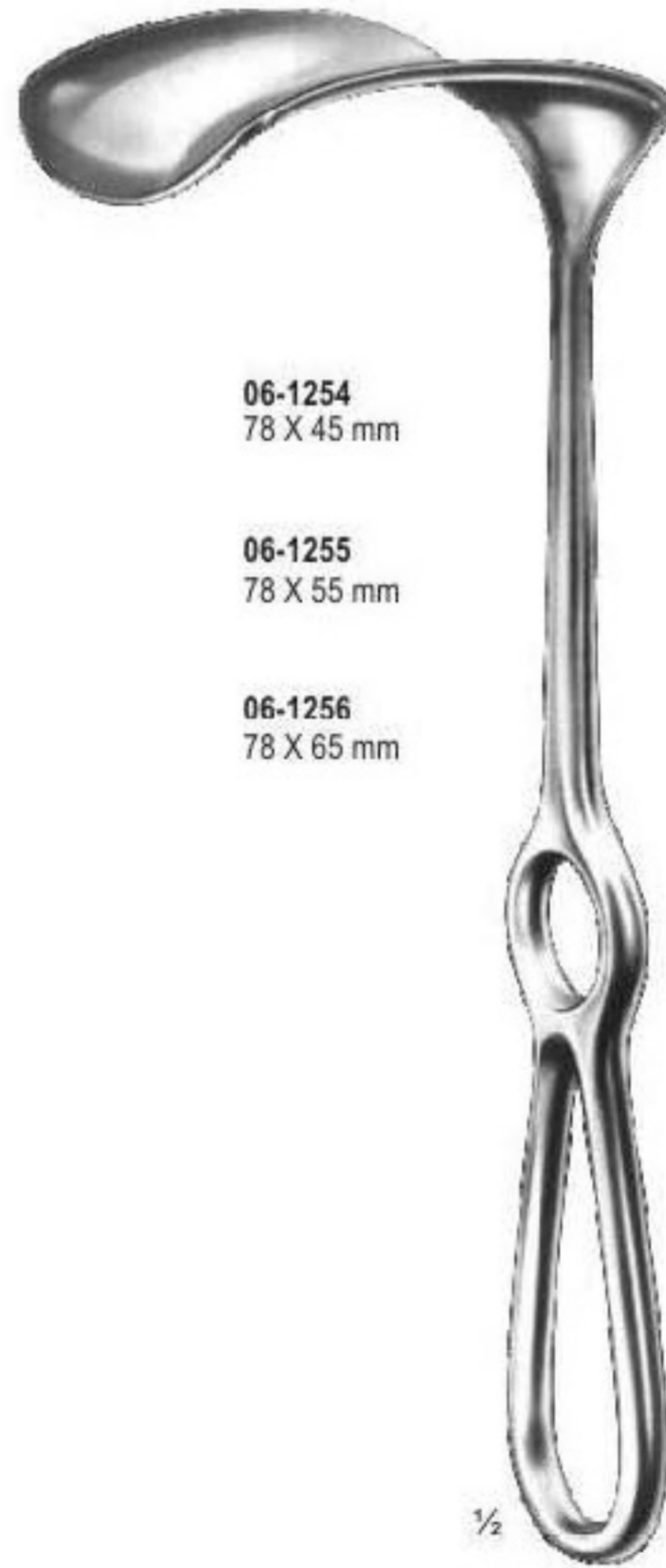

Fig. 6
06-1252
25.5 cm



KOCHER
06-1253
23.5 cm
70 X 25 mm

1/2



06-1254
78 X 45 mm

06-1255
78 X 55 mm

06-1256
78 X 65 mm

KOCHER
06-1254 - 06-1256
25 cm

1/2

Retractors, Lung Spatulas



Retractors, Lung Spatulas



Fig. 3
DEAVER
06-1260
30 cm

Fig. 4
DEAVER
06-1261
31 cm

Fig. 5
DEAVER
06-1262
32 cm

Retractors, Lung Spatulas



Fig. 1
DEAVER
06-1263
31 cm



Fig. 3
DEAVER
06-1264
31 cm

Retractors, Lung Spatulas



Fig. 3
DEAVER
06-1265
30.5 cm



Fig. 4
DEAVER
06-1266
31 cm

Atrium Retractors



COOLEY
06-1267
25 cm
Right
48 X 48 mm



COOLEY
06-1268
25 cm
Right, Serrated
48 X 48 mm



COOLEY
06-1269
27.5 cm
Left
30 X 48 mm

Retractors For Deep Surgery (abdominal Retractors)

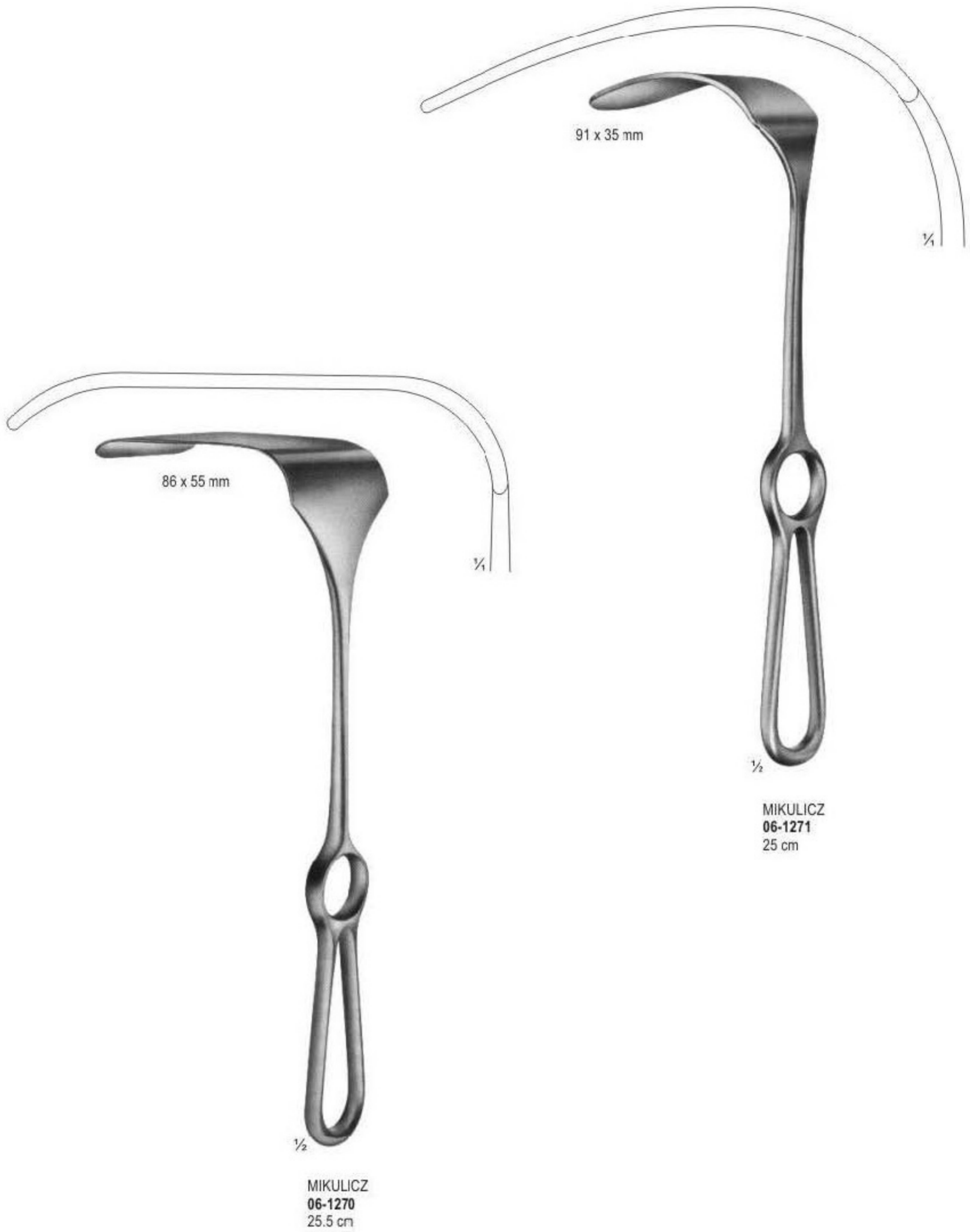

Retractors For Deep Surgery (abdominal Retractors)

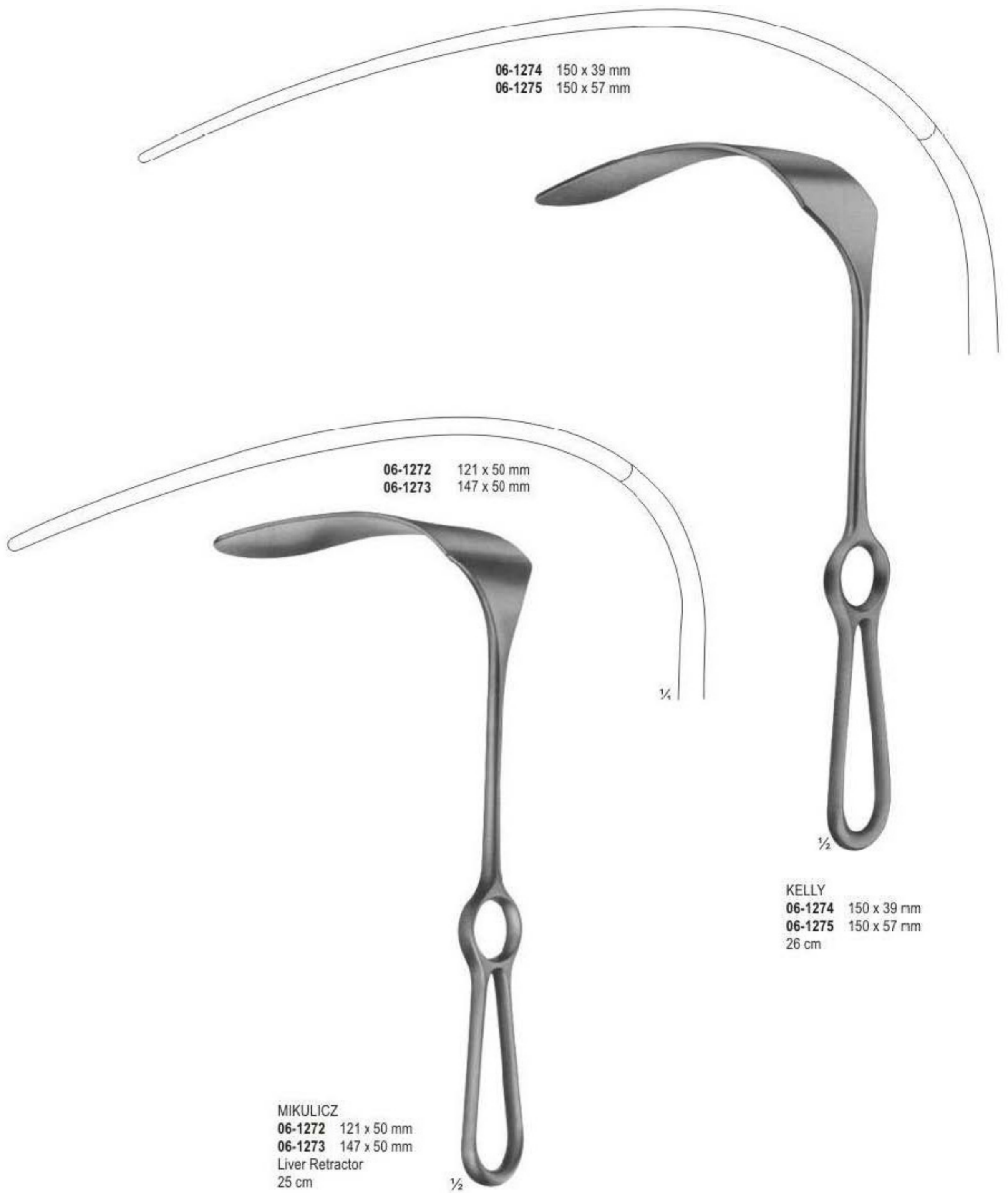

Retractors, Abdominal Retractors



Abdominal Retractors



ROCHARD
06-1283 - 06-1287
31 cm
06-1283 48 x 90 mm
06-1284 48 x 105 mm
06-1285 48 x 120 mm
06-1286 48 x 135 mm
06-1287 48 x 155 mm



06-1288



DOYEN
06-1289 - 06-1292
28 cm
06-1289 48 x 90 mm
06-1290 48 x 105 mm
06-1291 48 x 120 mm
06-1292 48 x 135 mm



DOYEN-CHILD
06-1293
Fixation device
22 cm



06-1294
Chain with
weight (747 / 645g)
79 cm

Pelvis Retractors

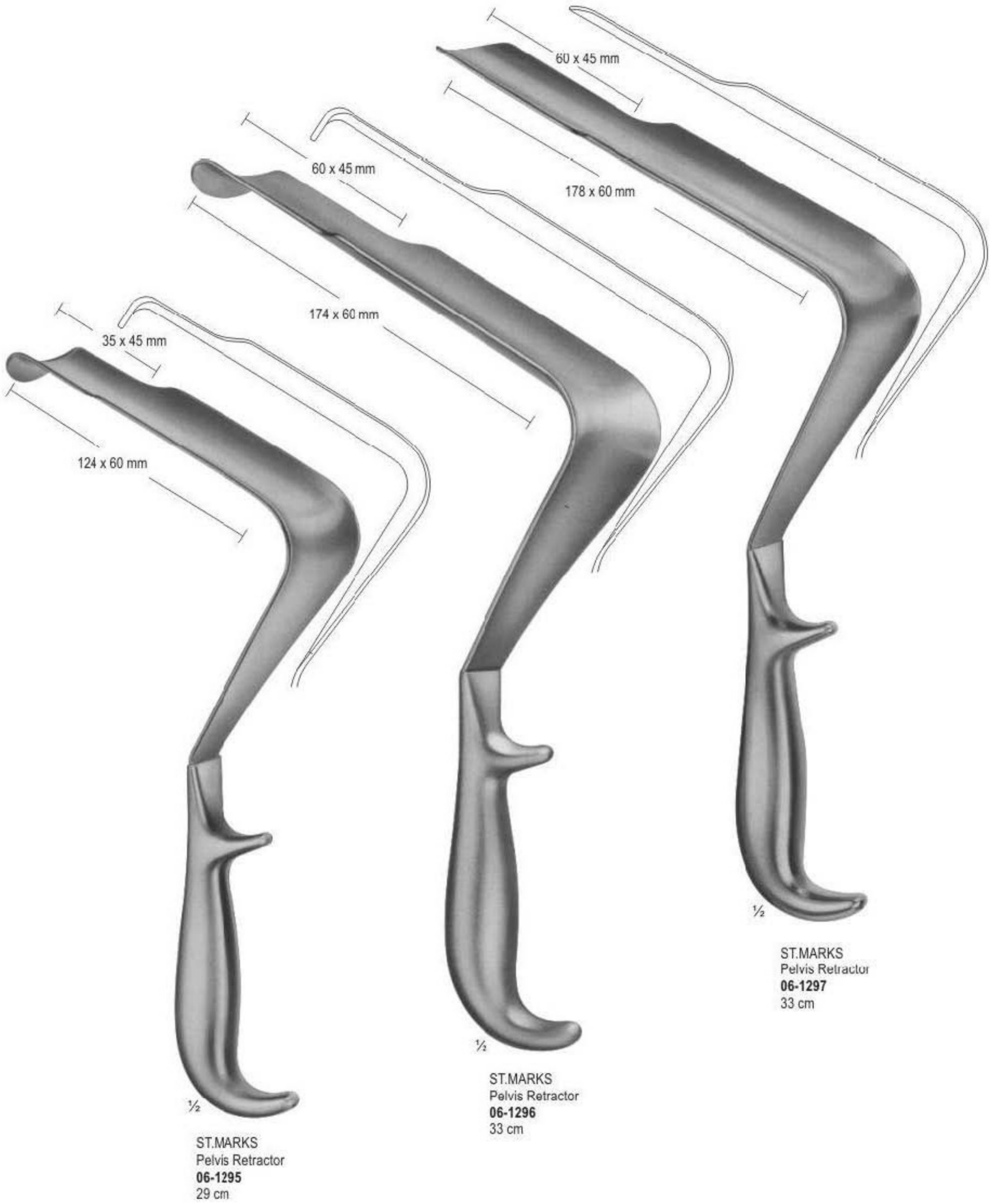

Abdominal- And Intestinal Spatulas



Hooklets



SENN-GREEN
06-1302 - 06-1303
16 cm



Fig. 1
06-1302
20 X 6 mm



Fig. 2
06-1303
10 X 6 mm



RAGNELL-DAVIS
06-1304
15 cm



$\frac{1}{4}$
8 X 4.5 mm

15 X 5.5 mm



CUSHING
06-1305
20.5 cm

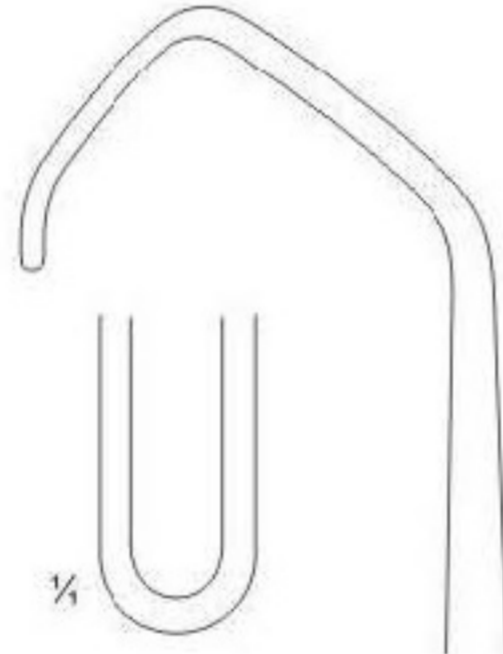

$\frac{1}{4}$

19 x 15 mm
19 x 15 mm



22 x 15 mm
22 x 15 mm

PARKER
06-1306
14 cm



Retractors

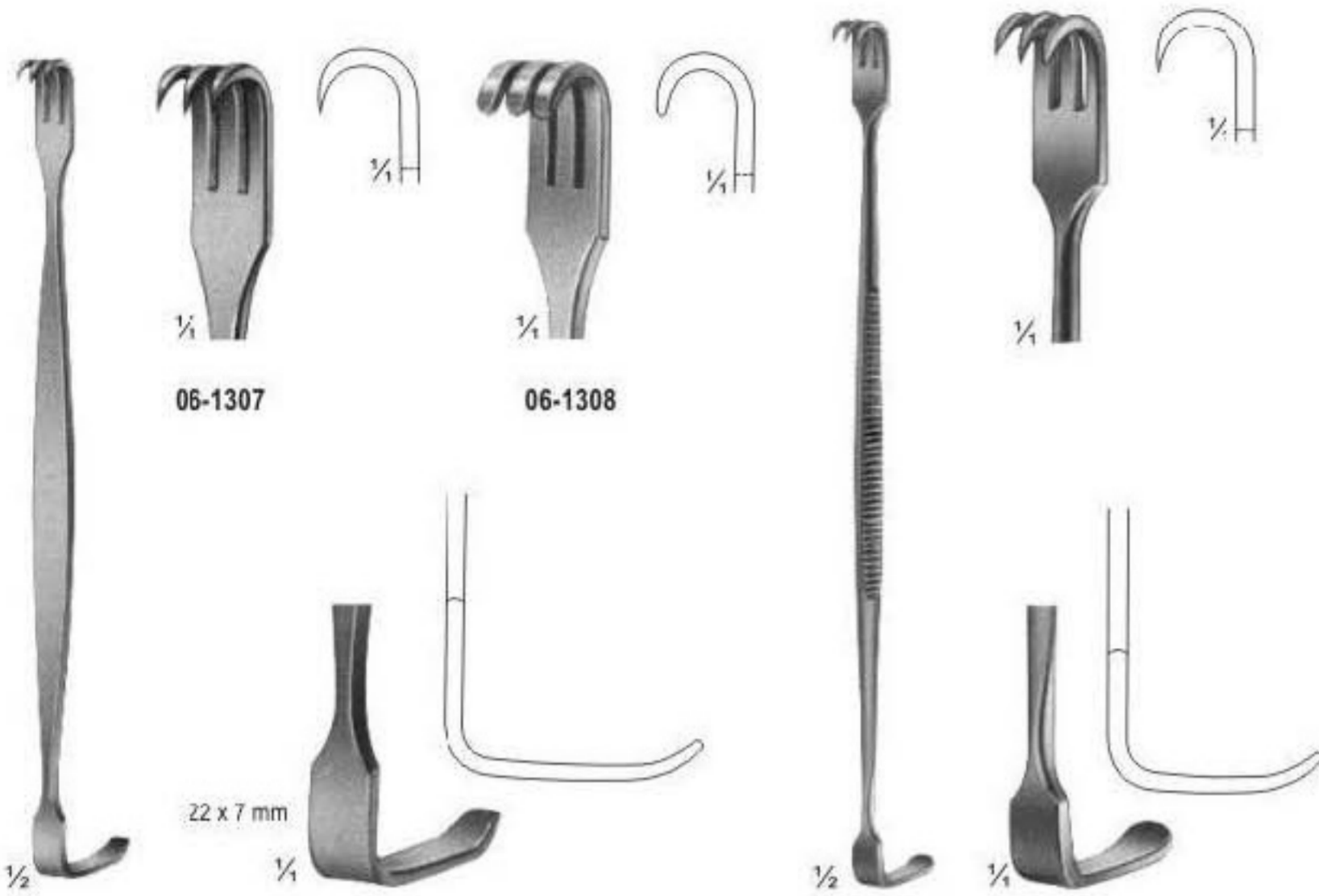

06-1307

06-1308

22 x 7 mm

BABY-SENN-MILLER
06-1307 - 06-1308
15.5 cm

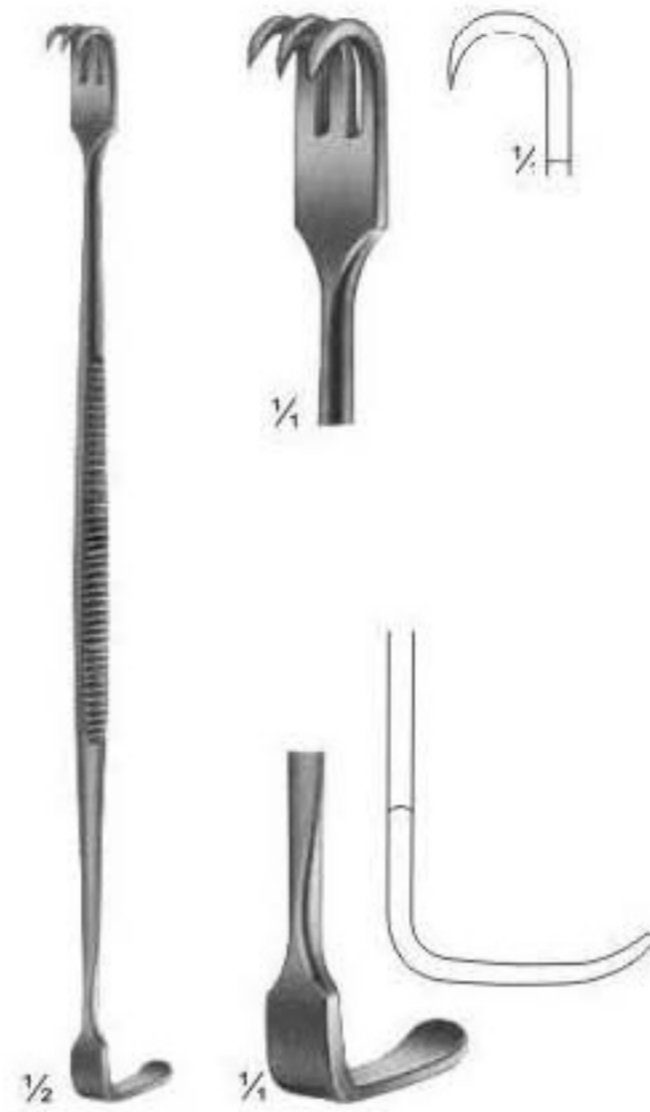

SENN-MILLER
06-1309
16.5 cm



COLLIN-HARTMANN
06-1310
15 cm

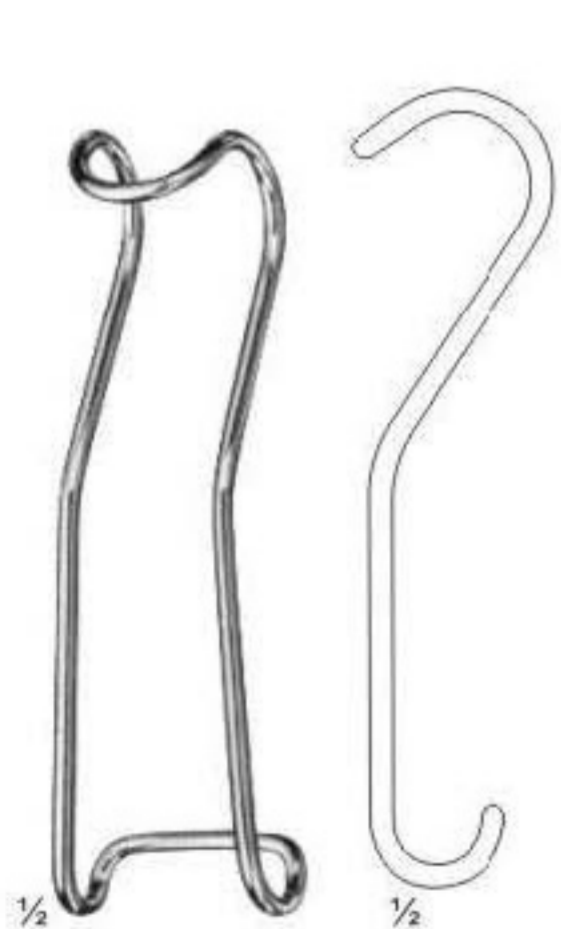

STERBERG
06-1311 - 06-1314
06-1311 12 cm
06-1312 13 cm
06-1312 13.5 cm
06-1314 14 cm

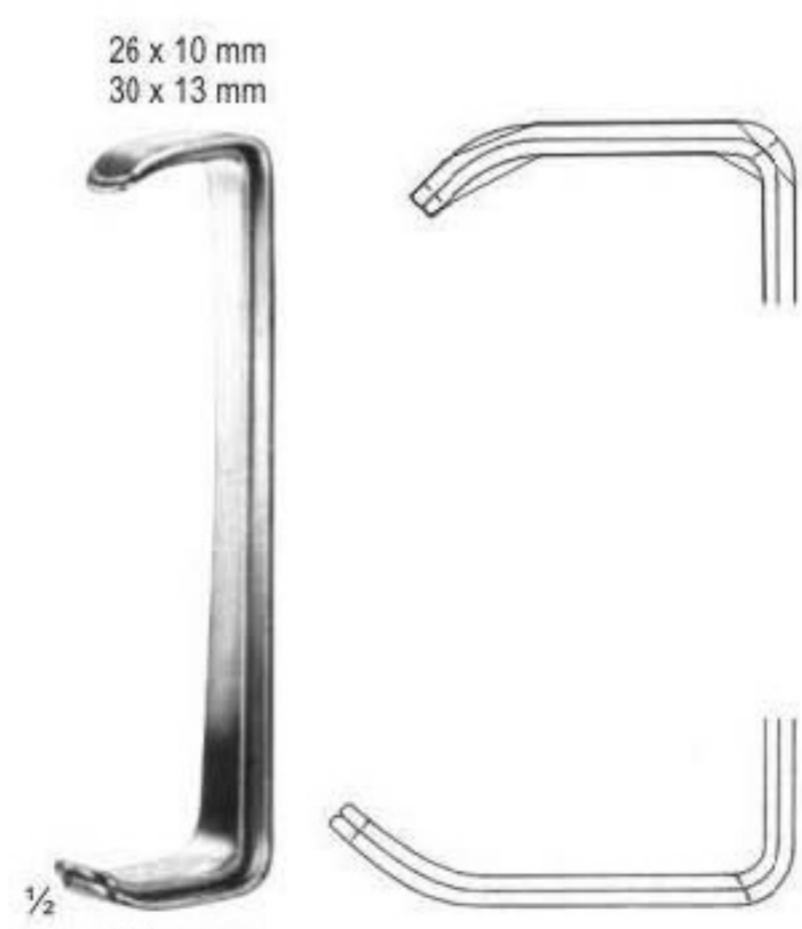

26 x 10 mm
30 x 13 mm

30 x 10 mm
34 x 13 mm

FARABEUF
06-1315
12 cm

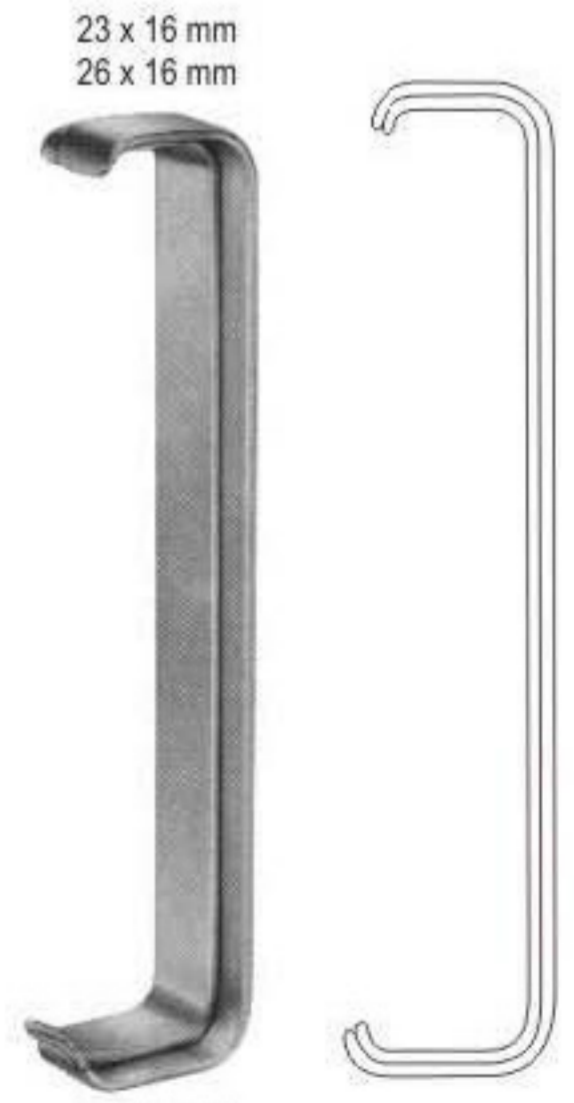

23 x 16 mm
26 x 16 mm

27 x 16 mm
30 x 16 mm

FARABEUF
06-1316
15 cm

Retractors

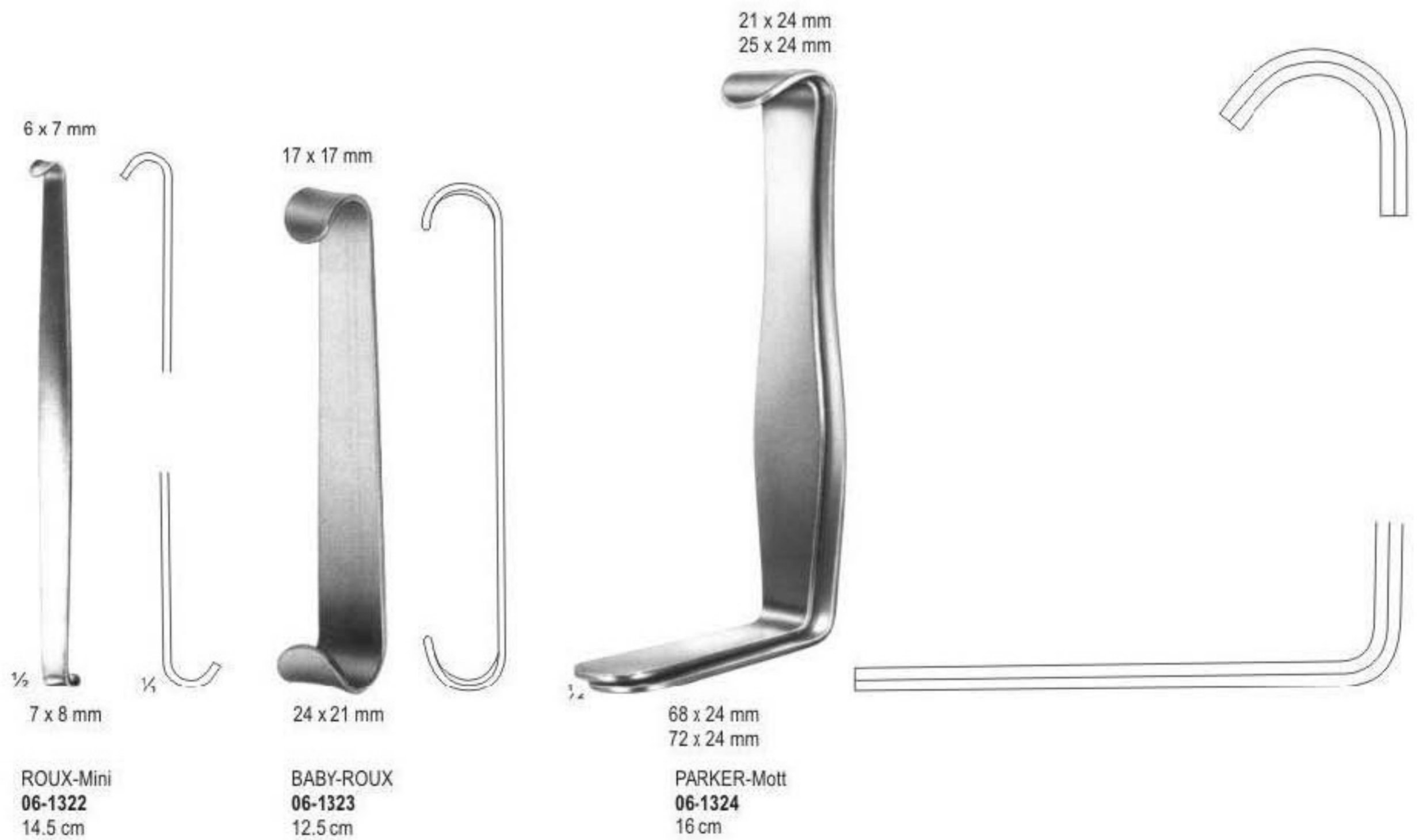
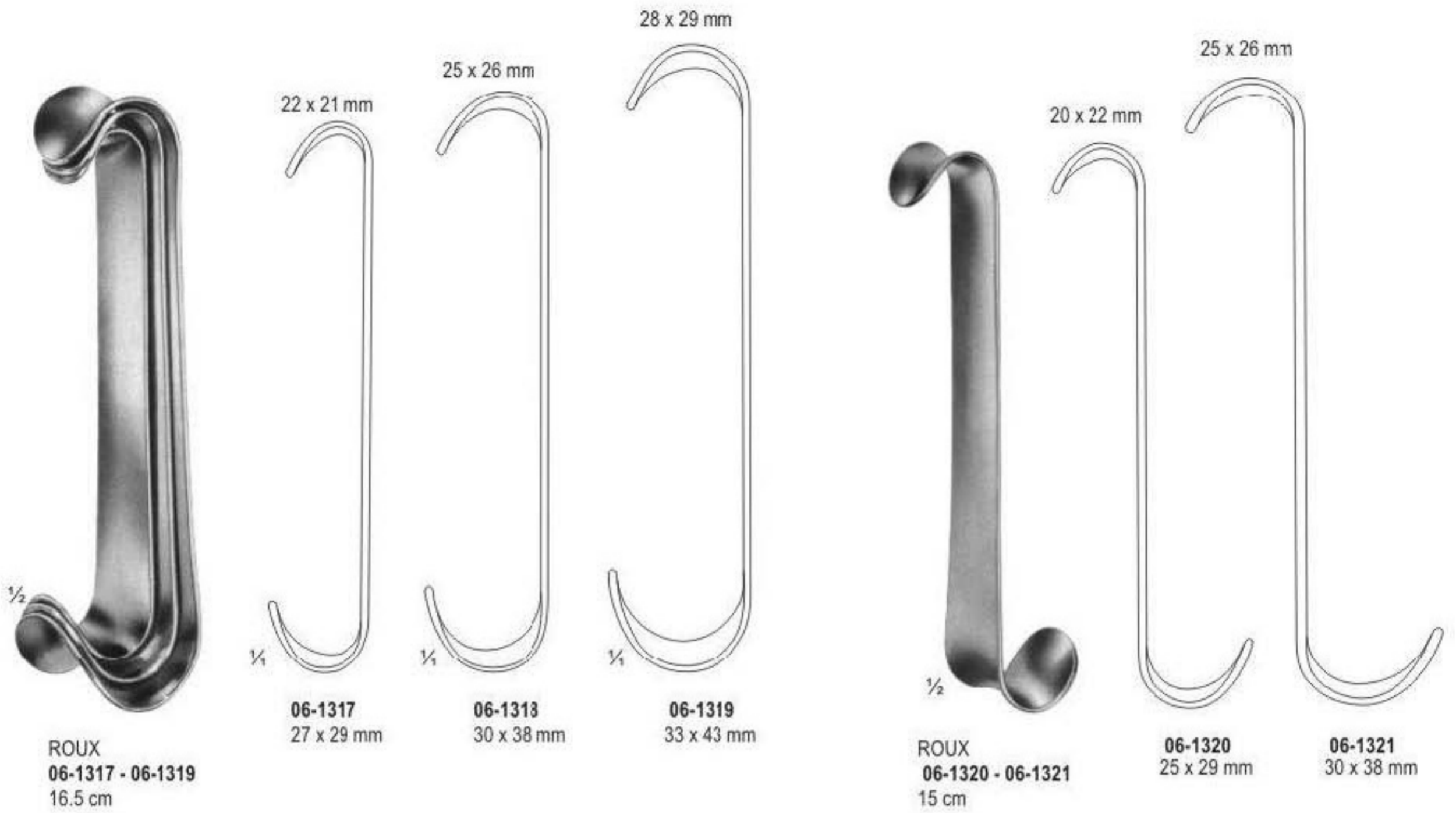

Retractors

10 x 8 mm



12 x 11 mm

LUER
06-1325
11 cm

11 x 4 mm



19 x 6 mm

CRILE
06-1326
11 cm

10 x 12 mm

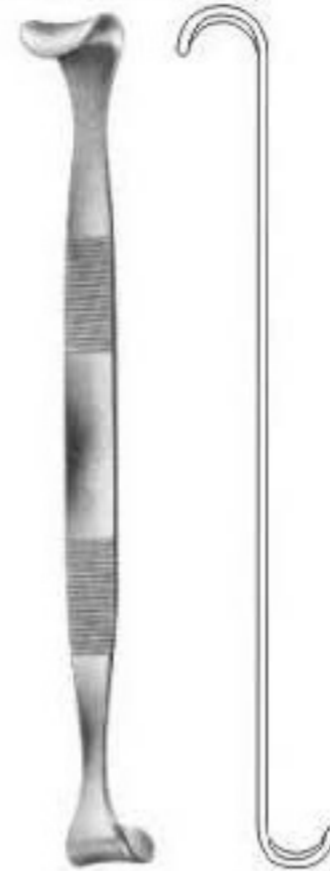

11 x 15 mm

ROSE
06-1327
13 cm

21 x 14 mm
17 x 14 mm



28 x 16 mm
32 x 16 mm

COLLIN
06-1328
15 cm



36 mm

1/2

CZERNY
06-1329
17.5 cm



38 x 42 mm

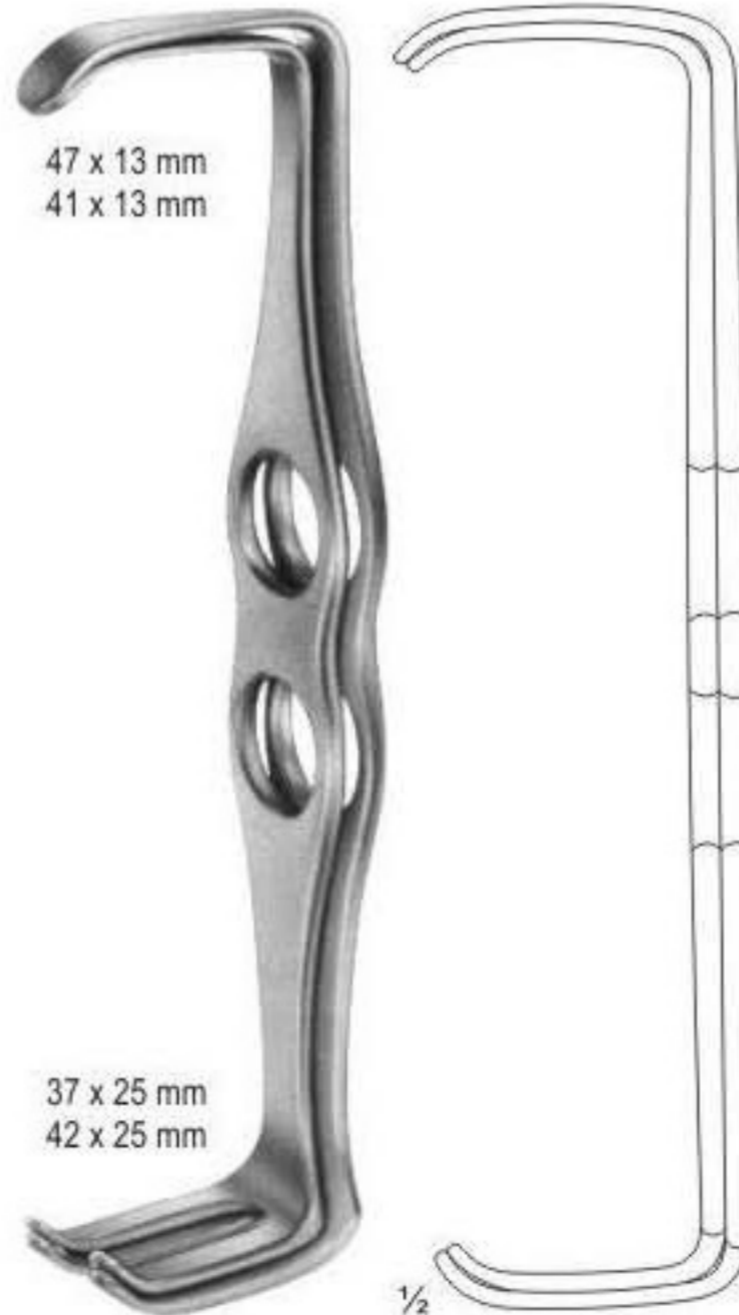

47 x 13 mm
41 x 13 mm

37 x 25 mm
42 x 25 mm

1/2

MATHIEU
06-1330
20 cm



26 x 15 mm
22 x 15 mm

39 x 15 mm
43 x 15 mm

1/2

US-ARMY
06-1331
22 cm

Wound Spreaders, Self-Retaining



BOSE
06-1332
60 mm



FINSEN
06-1333
50 mm



FINSEN
06-1334
70 mm



FINSEN modif.
06-1335
75 mm



06-1336
45 mm



06-1337
55 mm



MUELLER
06-1338
65 mm



ALM
06-1339 7 cm
06-1340 10 cm



06-1339



06-1340

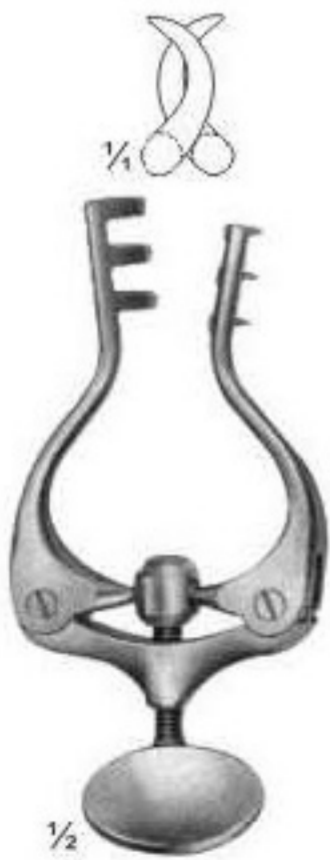

JANSEN
06-1341
100 mm



JANSEN
06-1342
100 mm

Self-retaining Retractors



WEITLANER
Sharp
06-1343
11 cm



WEITLANER
Semi-Sharp
06-1344
11 cm



WEITLANER
Blunt
06-1345
11 cm



WEITLANER
Sharp
06-1346
13 cm



WEITLANER
Semi-Sharp
06-1347
13 cm



WEITLANER
Blunt
06-1348
13 cm

Self-retaining Retractors



ADSON-BABY
Blunt
06-1349
14 cm

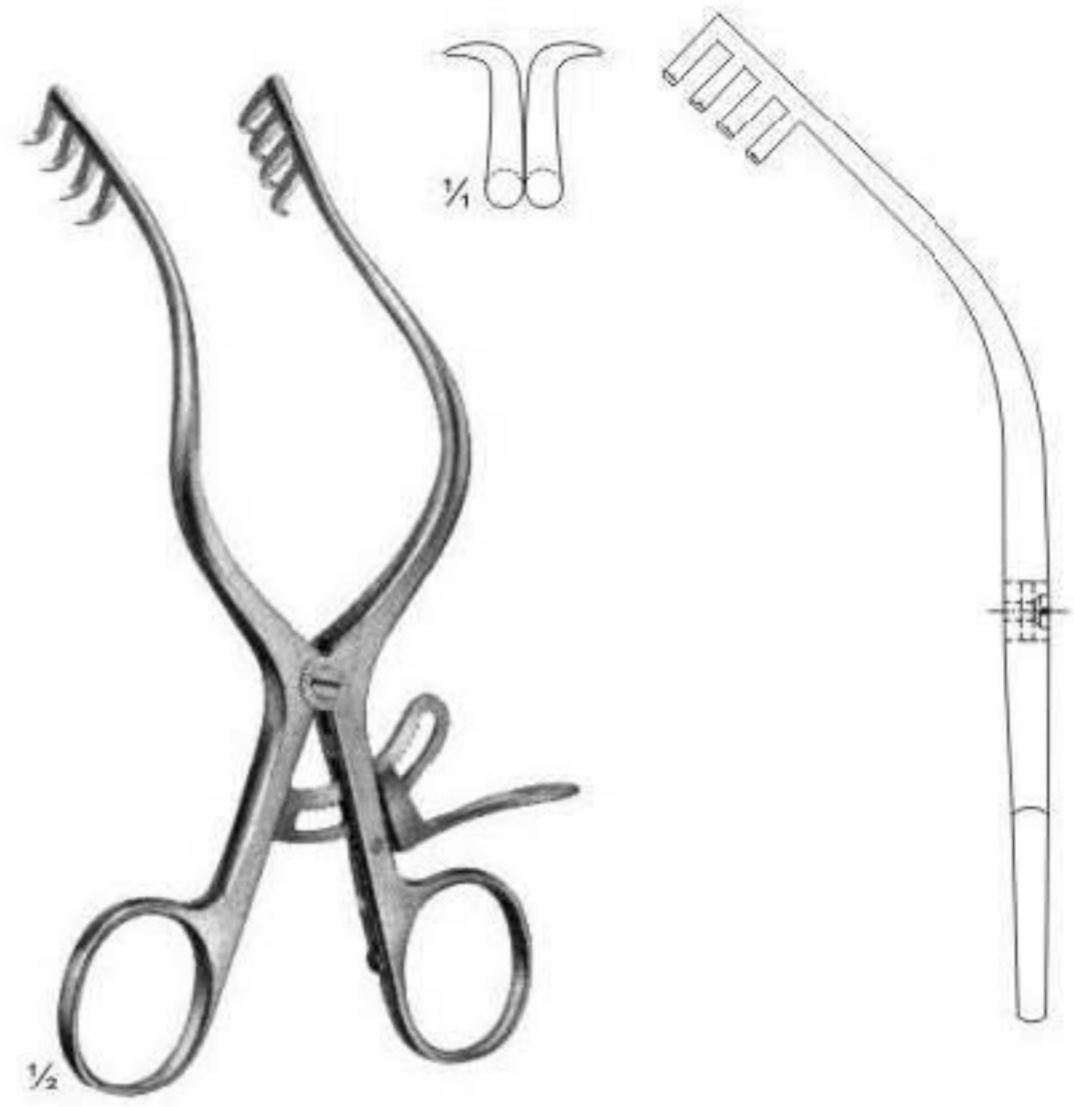

MOLLISON
Sharp
06-1350
15.5 cm



MAYO-ADAMS
06-1351
16.5 cm



TRAVERS
06-1352
21.5 cm

Self-retaining Retractors

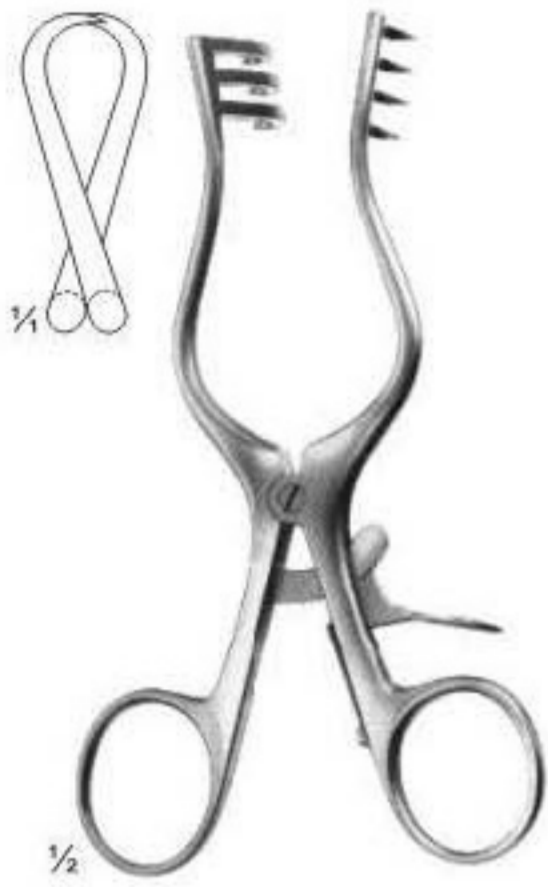

WEITLANER
Sharp
06-1353
13 cm

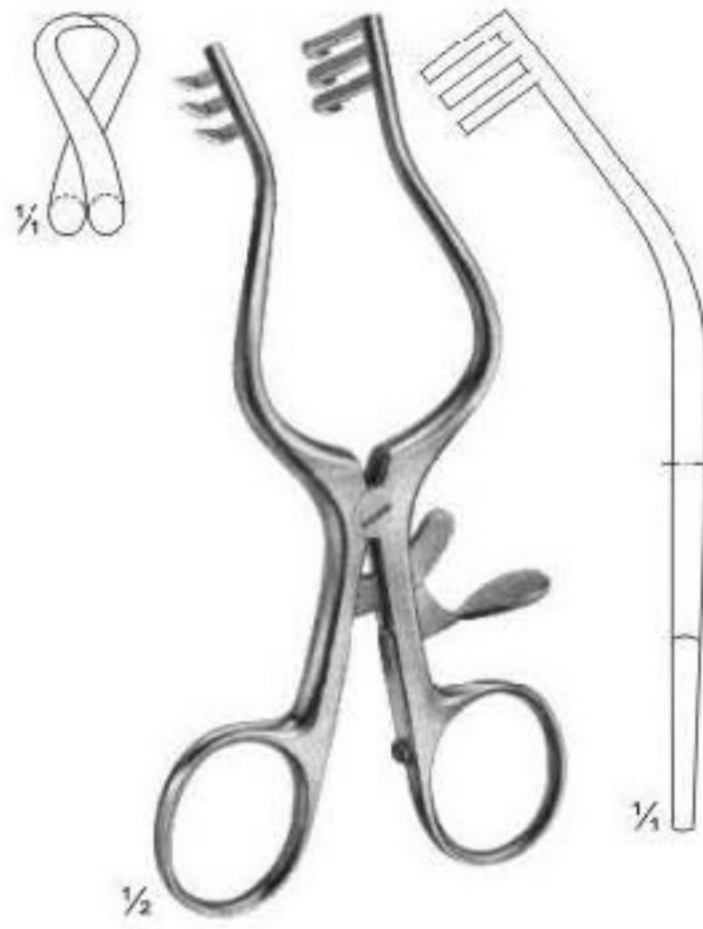

WULLSTEIN
Sharp
06-1354
13 cm

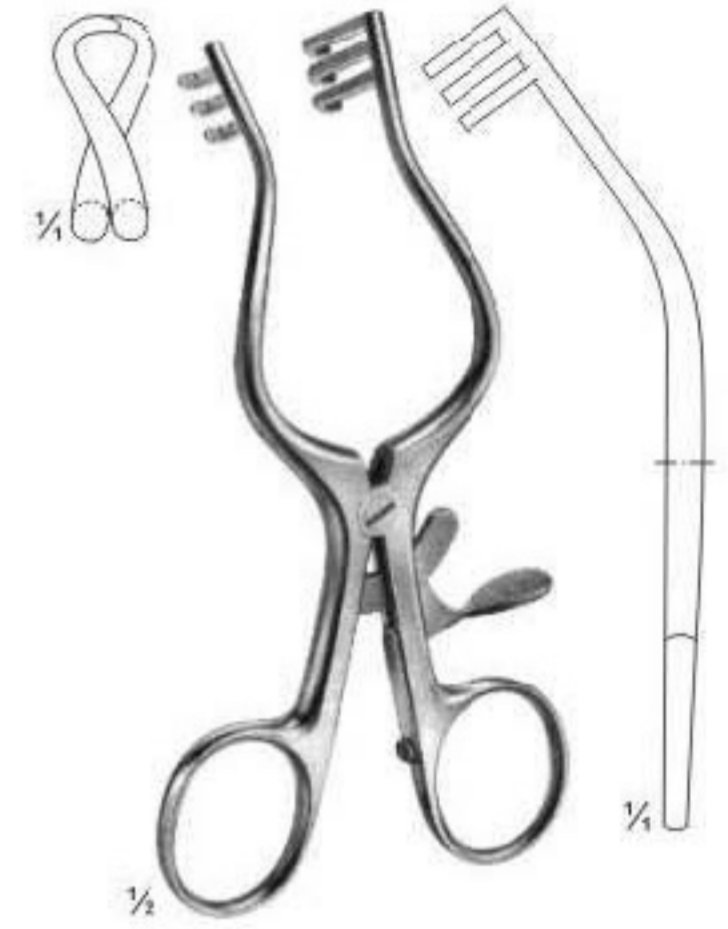

WULLSTEIN
Blunt
06-1355
13 cm



WEITLANER
Sharp
06-1356
16.5 cm



PLESTER
Blunt
06-1357
11 cm

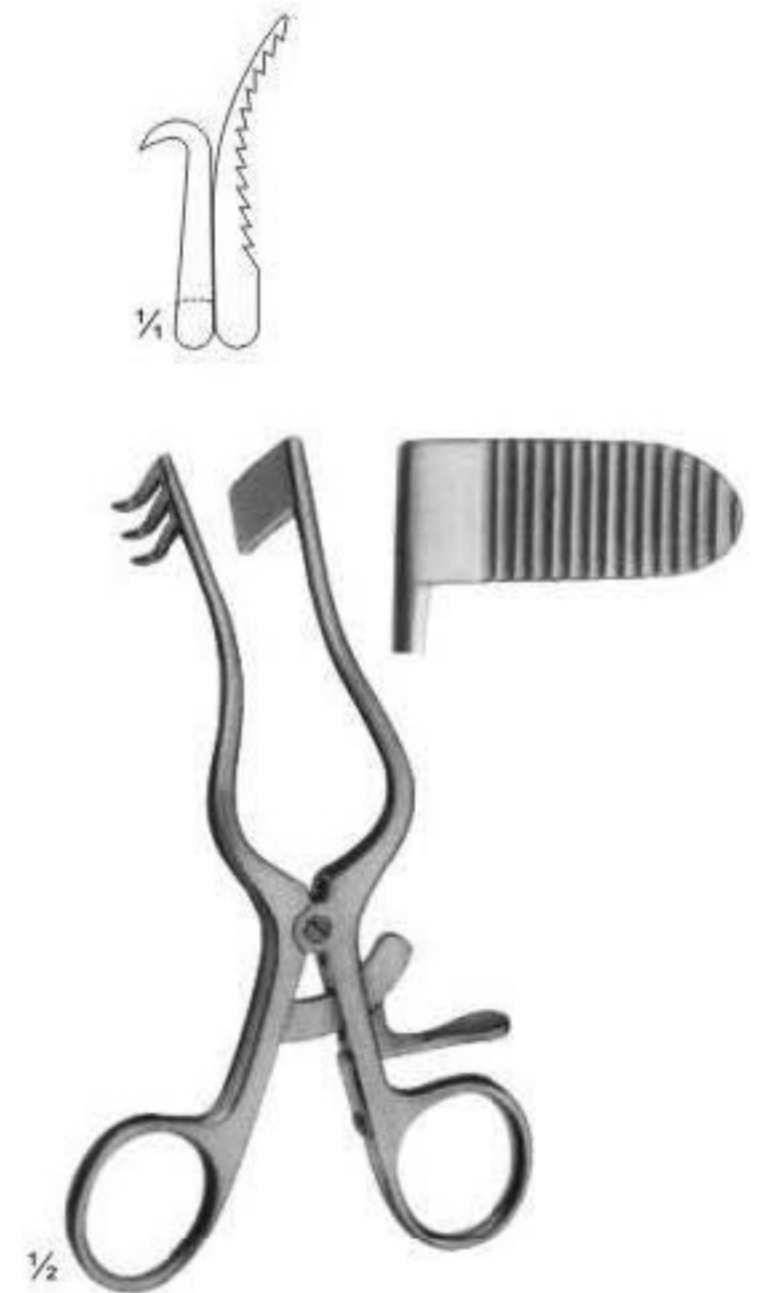

PERKINS
06-1358
13 cm

Wound Spreaders, Self-Retaining



HENLEY
Complete with 3 Central Baldes
06-1359 - 06-1361
16.5 cm

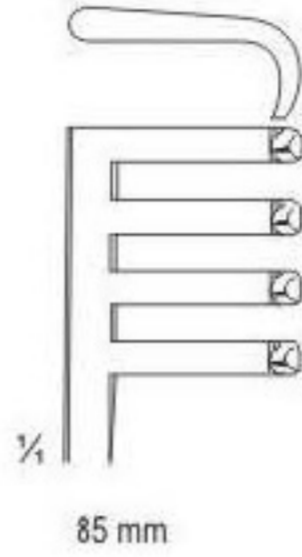

Blades
06-1359
19 X 17 mm



Blades
06-1360
25 X 17 mm



Blades
06-1361
32 X 17 mm

Self-retaining Laminectomy Retractors

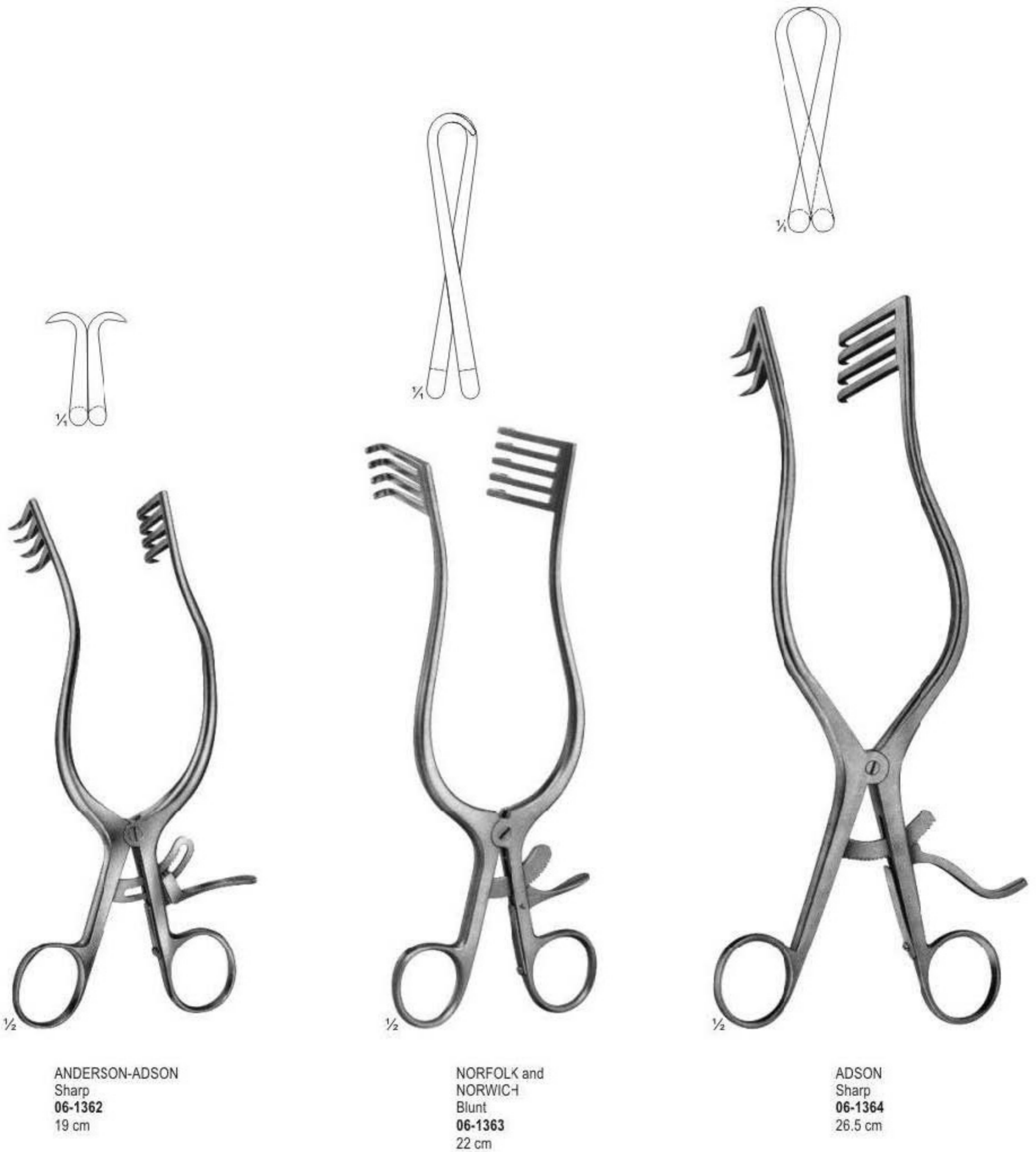

Self-retaining Laminectomy Retractors

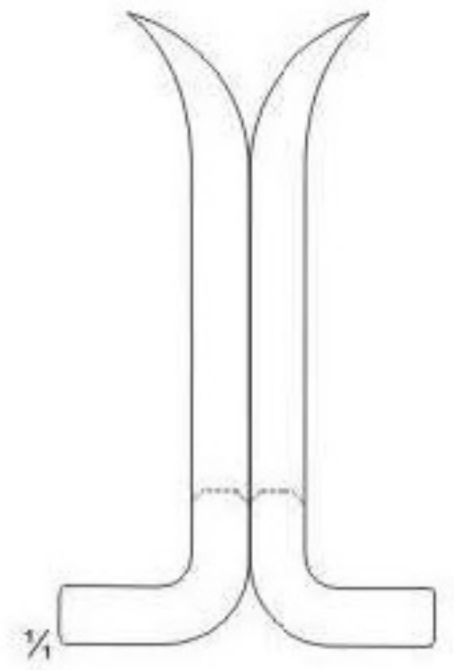
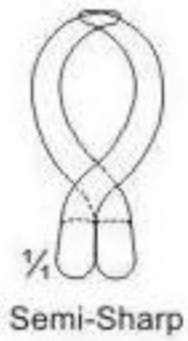
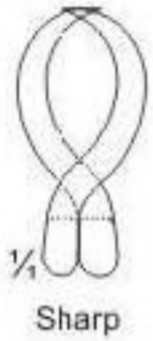

BECKMANN-ADSON
Sharp
06-1365
31 cm



BECKMANN-ADSON
Semi-Sharp
06-1366
31 cm



ADSON
Semi-Sharp
06-1367
32 cm



BECKMANN-EATON
Sharp
06-1368
32 cm

Special Retractors



1/2

JOLL (FRIEDMAN)
06-1369
Thyroid and Vaginal Retractor
15.5 cm



1/2

JACKSON BURROWS
06-1370
Retractor, blunt
18.5 cm

1/4

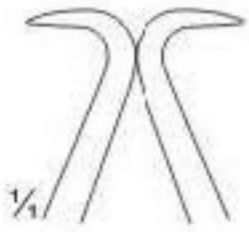

1/4



1/2

GELPI
06-1371
13.5 cm

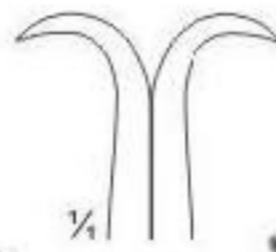

1/4



1/2

GELPI
06-1372
17.5 cm

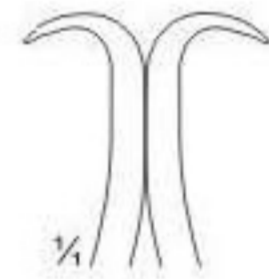

1/4



1/2

DE BAKEY
06-1373
14.5 cm

Self Retaining Retractors For Laminectomy And Other Operations



SCOVILLE-RICHTER
06-1374 - 06-1377
Retractor with 1 pair blades reversible type. The Retractor bar and shanks may be easily rotated 130° when blades are in site.



06-1374
62 x 52 mm 62 x 37 mm
PR= Pair



06-1375
47 x 51 mm



06-1376
30 x 40 mm



06-1377
37 x 62 mm

Retractors For Cervical Spine



CLOWARD modif.
Spreader Only
06-1378 - 06-1387

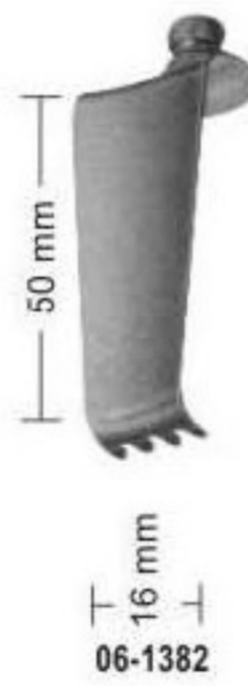

Wound Spreaders, Self-Retaining and Abdominal Retaining



BABY-COLLIN
06-1388 20 cm
complete, with 2 pair of lateral blades
Ref. **06-1388** (18 X 40 mm) and (27 X 40mm)
Spreading 80 mm



COLLIN
06-1389 24 cm
complete Ref. **06-1389** (38 X 60 mm)
Spreading 80 mm



Central Blade
06-1390
06-1391
06-1392

06-1390 22.5 cm
complete, with 1 pair of lateral blades
Ref. **06-1390** (38 X 60 mm) and central blade
(38 X 55 mm) Spreading 85 mm

06-1391 22.5 cm
complete, with 1 pair of lateral blades
Ref. **06-1391** (45 X 80 mm) and central blade
(50 X 75 mm) Spreading 80 mm

06-1392 31 cm
complete, with 1 pair of lateral blades
Ref. **06-1392** (60 X 80 mm) and central blade
(60 X 75 mm) Spreading 130 mm

COLLIN
06-1390 - 06-491-31
06-1390 22.5 cm
06-1391 22.5 cm
06-1392 31 cm

Abdominal Retractors



Center blade

06-1393
55 X 70 mm

06-1394
80 X 90 mm



Lateral blades
06-1396

06-1397
18 X 40 mm

06-1398
27 X 40 mm

06-1399
38 X 60 mm

06-1400
40 X 80 mm

06-1401
45 X 80 mm

06-1402
60 X 80 mm

06-1393
Ricard complete, with 1 pair of lateral blades
(60 X 80 mm) and Center blade (55 X 70)

06-1394
Ricard complete, with 1 pair of lateral blades
(72 X 85 mm) and Center blade (80 X 90)

06-1395
Spreader Only

RICARD
06-1393 - 06-1402



Lateral blades

06-1405
(59 X 80 mm)



Center blade

06-1405
74 X 82 mm

06-1403
Holzbach complete, with 1 pair of lateral blades
(59 X 80 mm) and Center blade (74 X 82)
Spreading 275 mm

06-1404
Spreader only

HOLZBACH
06-1403 - 06-1405

Abdominal Retractors



GOSSET-BABY
06-1406
12.5 cm
Lateral blades (40 X 30 mm deep)
Spreading 120 mm



BALFOUR-BABY
06-1407
Lateral blades 27 mm deep
Center blade 21x24 mm



GOSSET
06-1408
18.5 cm
Lateral blades (63 X 65 mm deep)
Spreading 140 mm



GOSSET
06-1409
16.5 cm
Lateral blades (63 X 35 mm deep)
06-1410 1 Center blade (60 x 56 mm)
Spreading 160 mm



HERTZLER
06-1411
Blades 20 X 25 mm

Abdominal Retractors

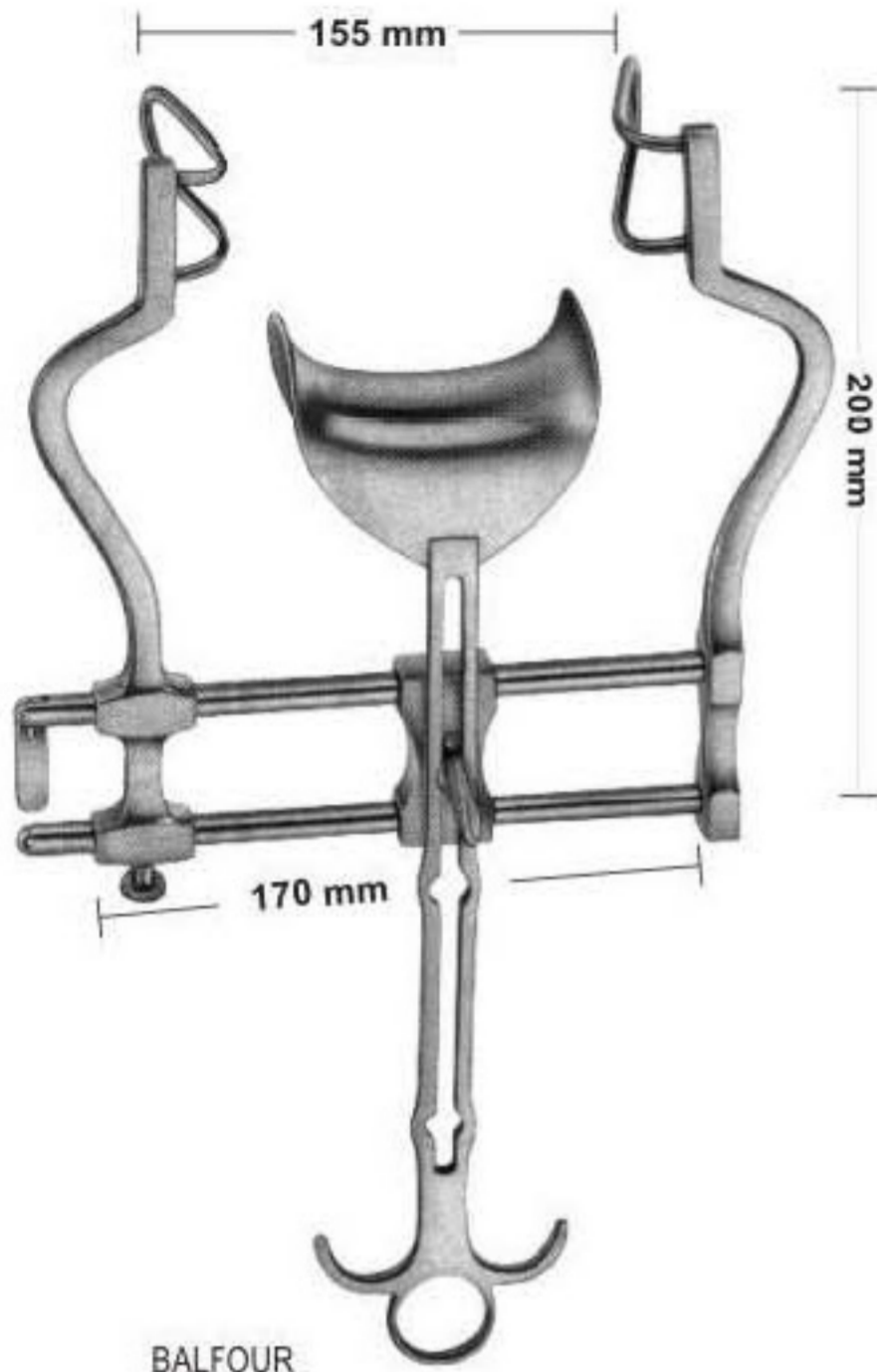

BALFOUR
06-1412
Lateral blades 60 mm deep
Center blade 47 x 80 mm

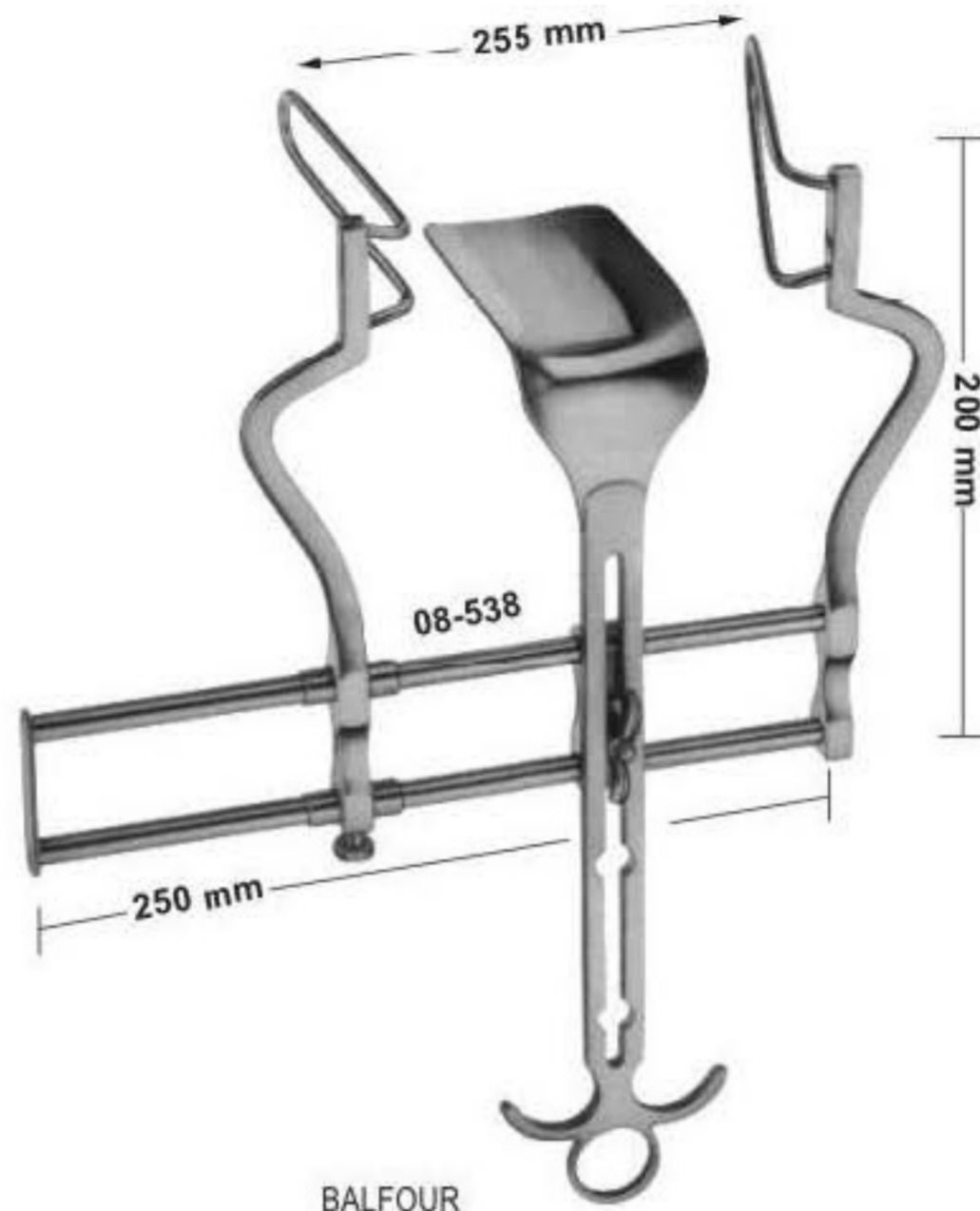

BALFOUR
06-1413
Lateral blades 105 mm deep
Center blade 107x 59 mm



06-1414
Center blade only
54x80 mm

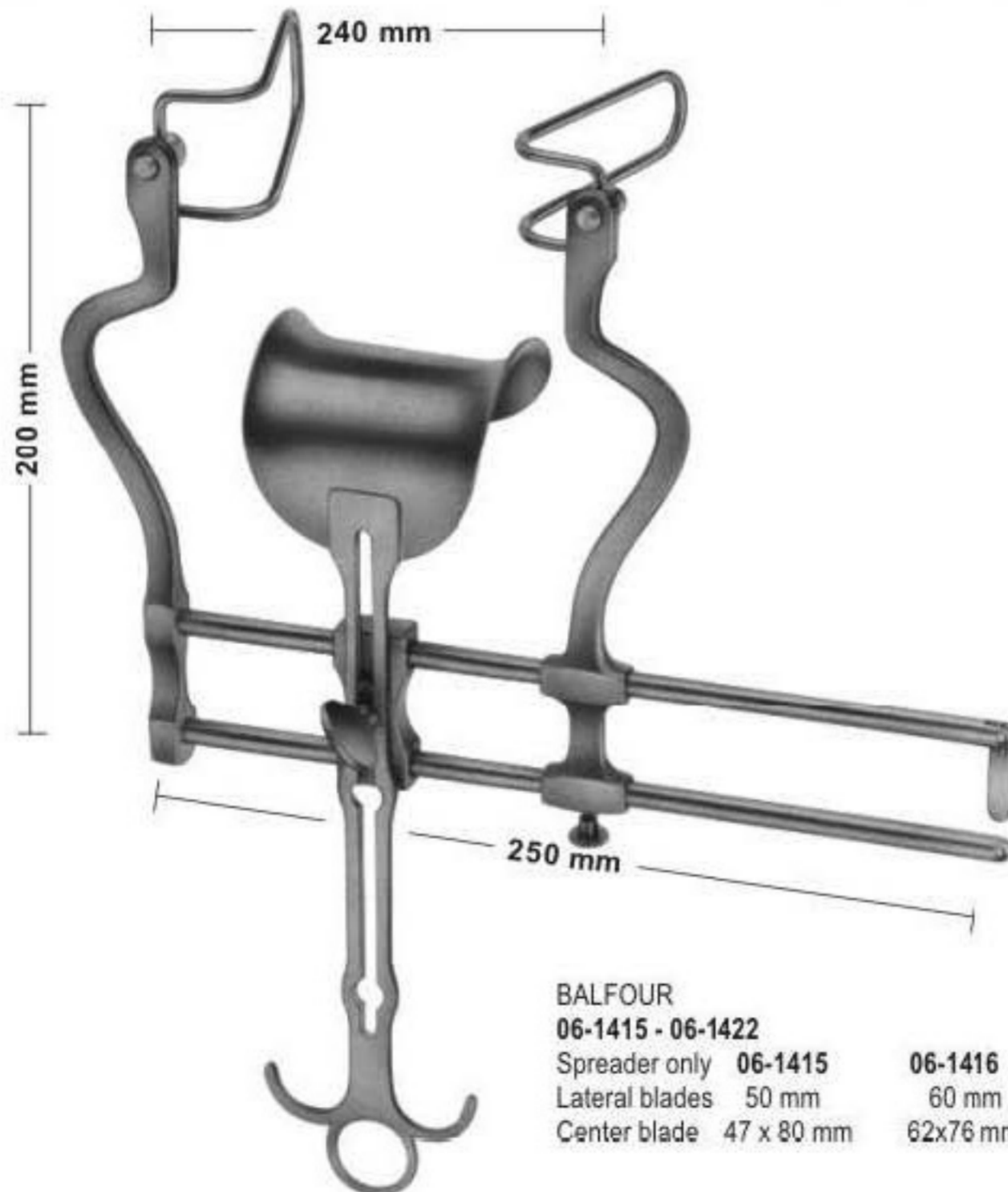

BALFOUR
06-1415 - 06-1422
Spreader only **06-1415** **06-1416** **06-1417** **06-1418**
Lateral blades 50 mm 60 mm 75 mm 90 mm
Center blade 47 x 80 mm 62x76 mm 80x80 mm 80x80 mm



Sales Unit of blades: PR = pair

Lateral blades
06-1419 50 mm deep
06-1420 60 mm deep
06-1421 75 mm deep
06-1422 90 mm deep

Abdominal Retractors

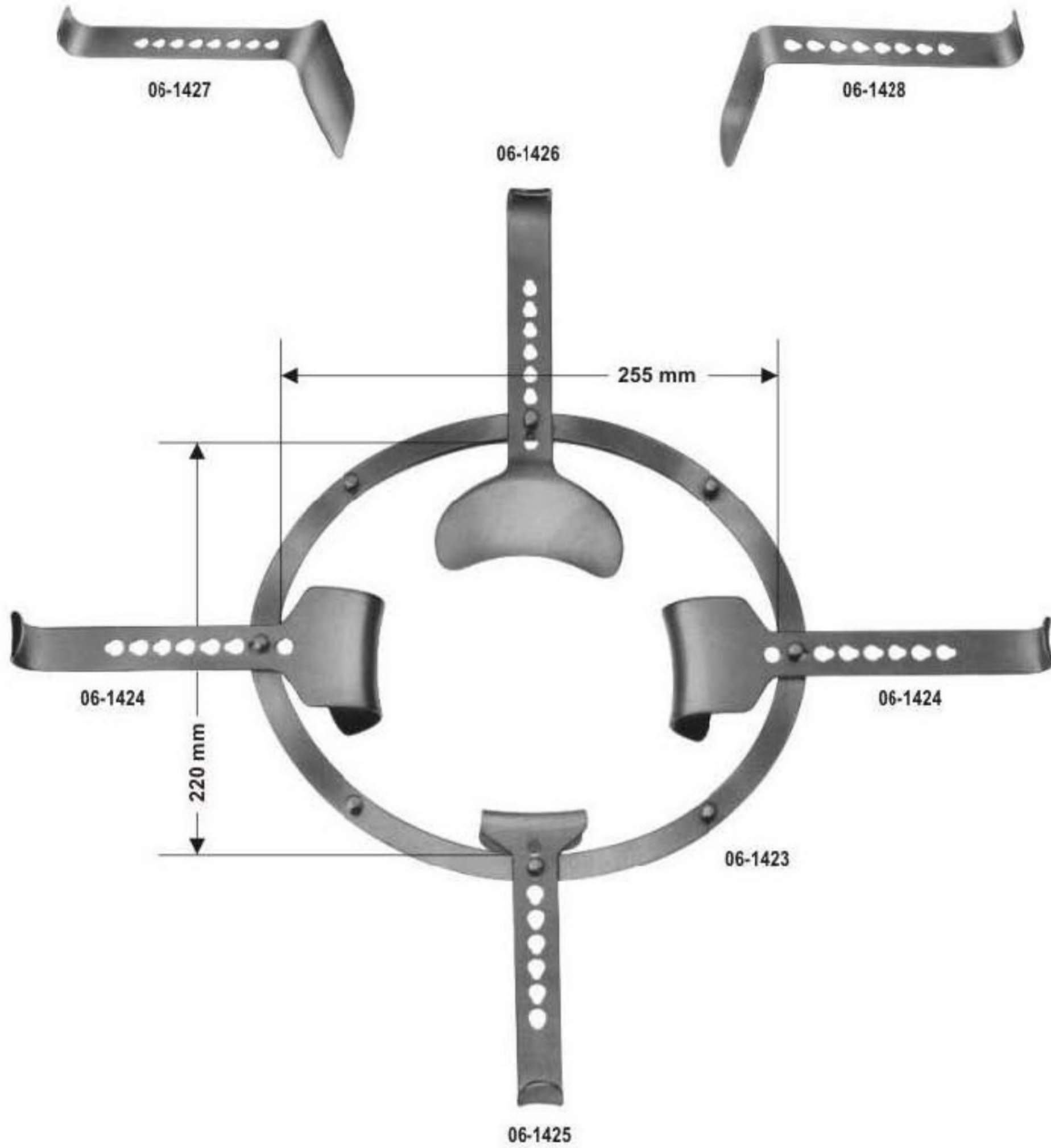

- SEMM
06-1423 - 06-1428
 consisting of:
06-1423 1 frame 225 x 220 mm
06-1424 2 blades 46 x 64 mm
06-1425 1 blade 53 x 54 mm
 (for bladder)
06-1426 1 blade 82 x 97 mm
 (for intestine)
06-1427 1 blade 98 x 51 mm
 (for intestine)
06-1428 1 blade, narrow
 107 x 36 mm

Abdominal Retractors

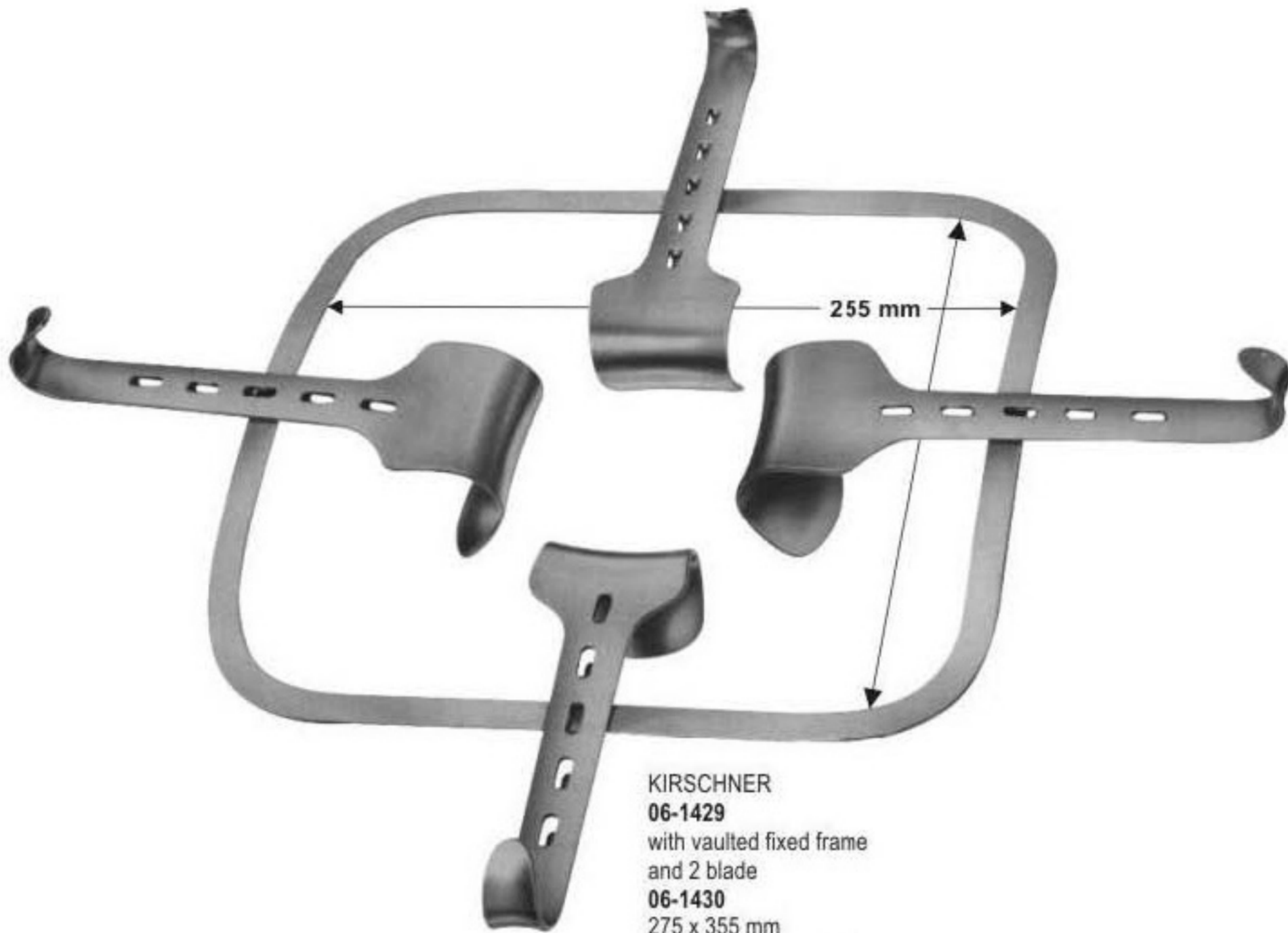

KIRSCHNER
06-1429
with vaulted fixed frame
and 2 blade
06-1430
275 x 355 mm
Frame only, over-sized
06-1431
295 x 275 mm
Frame only



KIRSCHNER
06-1432
64 x 80 mm



KIRSCHNER-BALFOUR
06-1433
80x 82 mm



KIRSCHNER
06-1434 - 06-1436
06-1434 90x 69mm
06-1435 92x 95mm
06-1436 78x 58mm



KIRSCHNER
06-1437 - 06-1439
06-1437 108x42mm
06-1438 91x 55mm
06-1439 121x 55mm

Abdominal- And Intestinal Spatulas



REVERDIN
06-1440
28.5 cm



HABERER
Malleable
06-1441
30.5 cm



06-1442 - 06-1445
06-1442 30 mm
06-1443 40 mm
06-1444 50 mm
Malleable
33 cm



TUFFIER
Malleable
06-1445
20 cm

Page 160-174

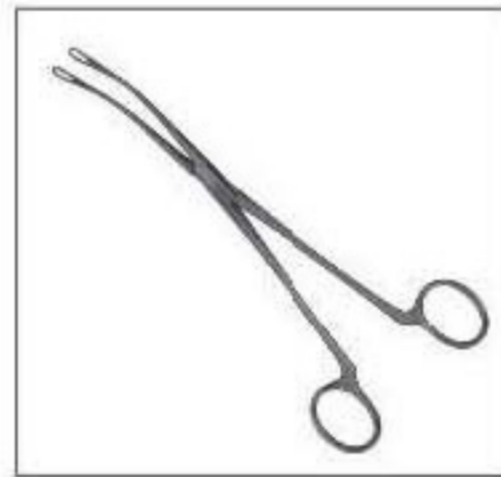

- Kidney Stone Forceps
- Gall Stone Forceps
- Nephrostomy Forceps
- Capsule Forceps
- Bladder Retractors
- Prostatic Retractors
- Gall Duct Dilators & Gall Stone Scoops
- Gall Duct Probes
- Genito-urinary Instruments



Kidney Stone Forceps



Fig. 1
07-1001
23 cm



Fig. 2
07-1002
21 cm



Fig. 3
07-1003
19 cm



Fig. 4
07-1004
18.5 cm



Fig. 5
07-1005
19 cm



RANDALL
07-1004 - 07-1006



Fig. 6
07-1006
19 cm

Gall Stone Forceps

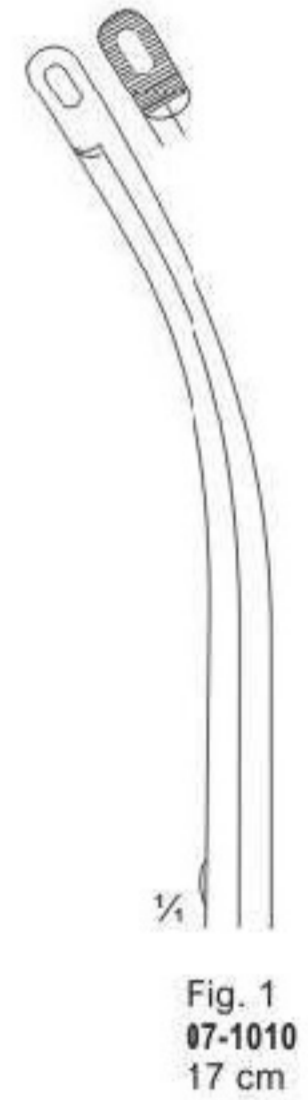
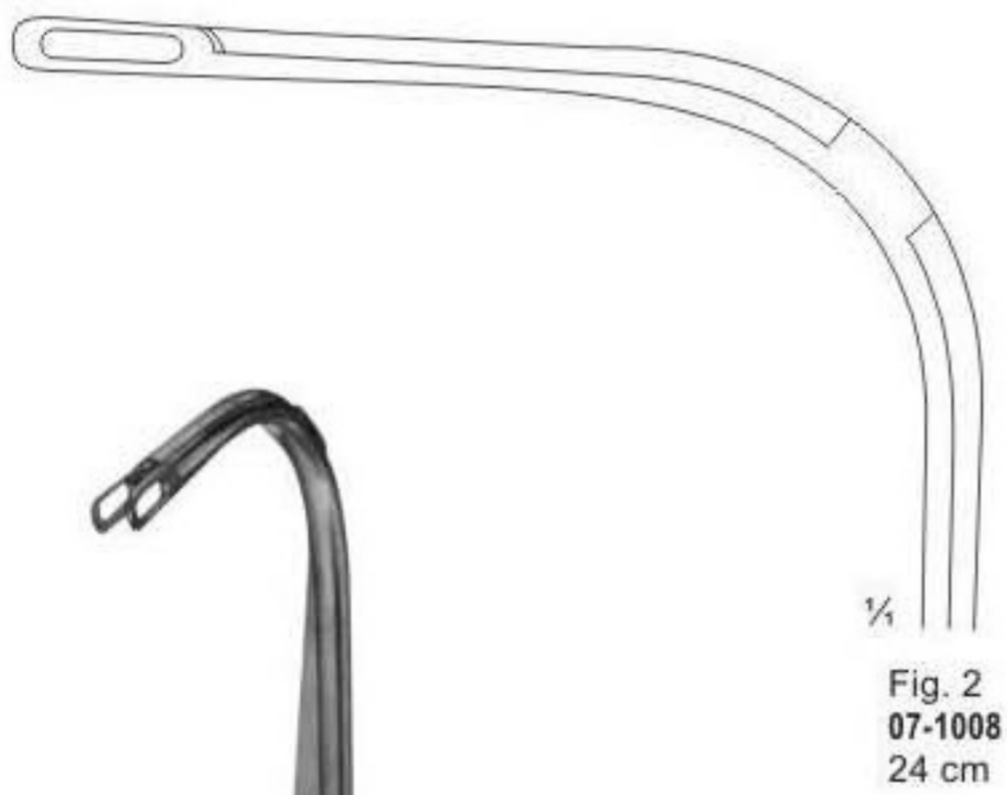
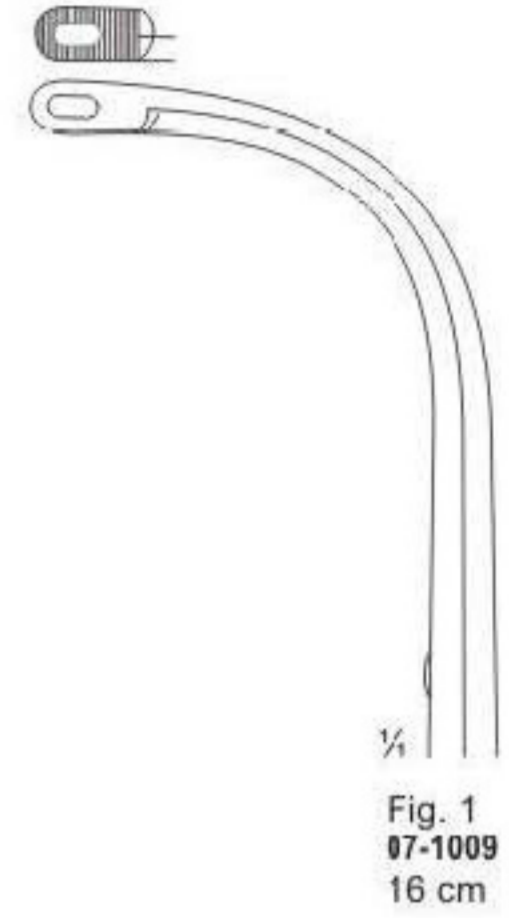
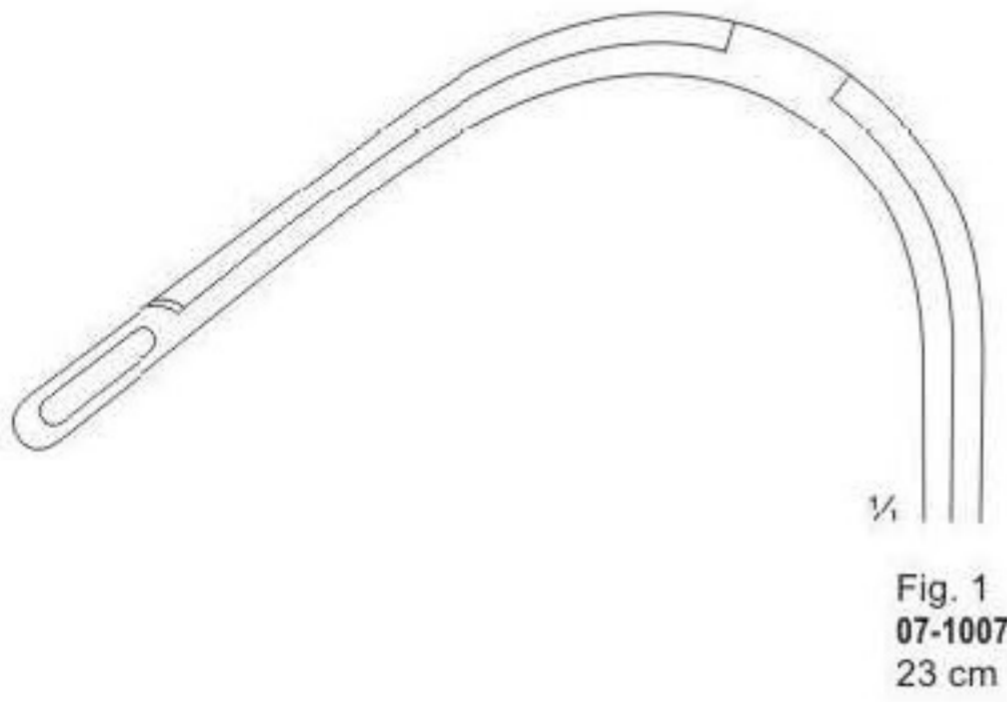

RANDALL
07-1007 - 07-1008



HEIMING
07-1009 - 07-1010

Nephrostomy Forceps



ELSÄSSER
07-1011 - 07-1012
21 cm

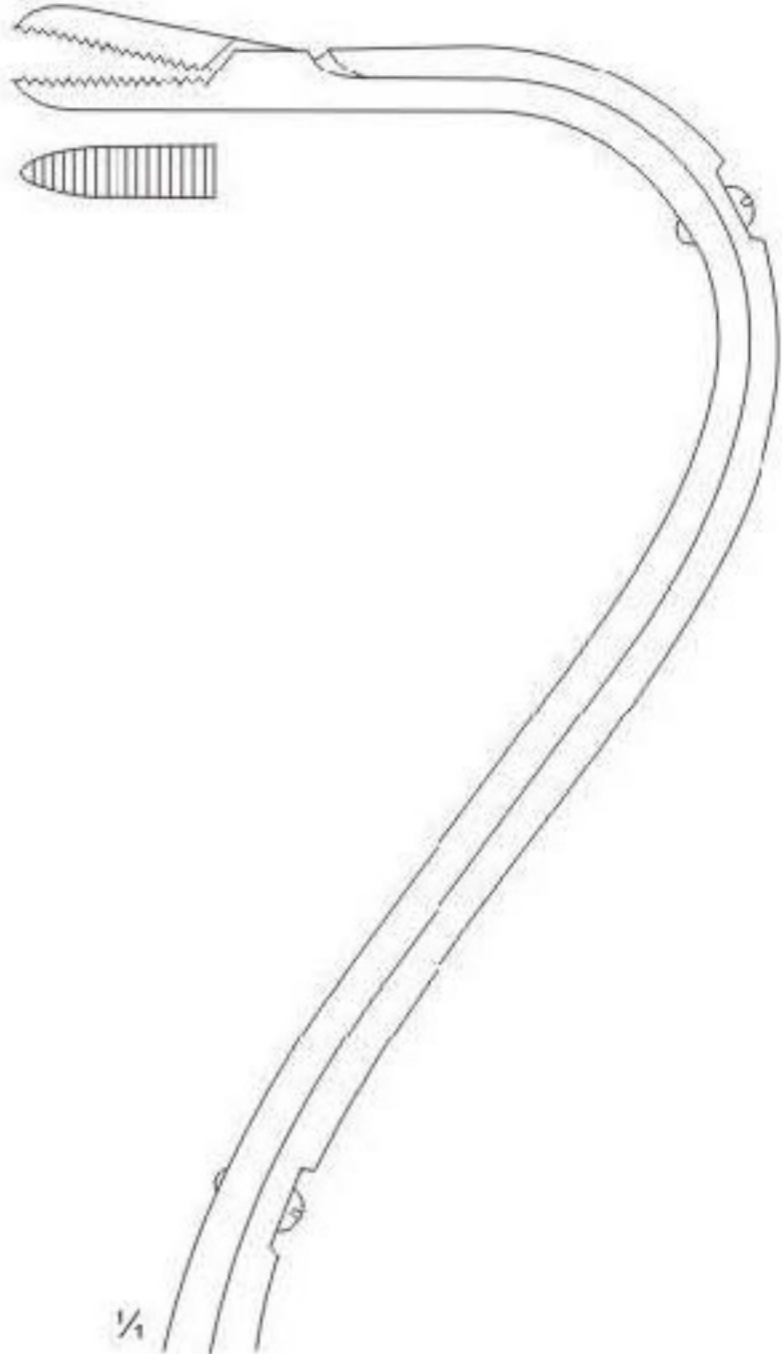

Fig. 1
07-1011

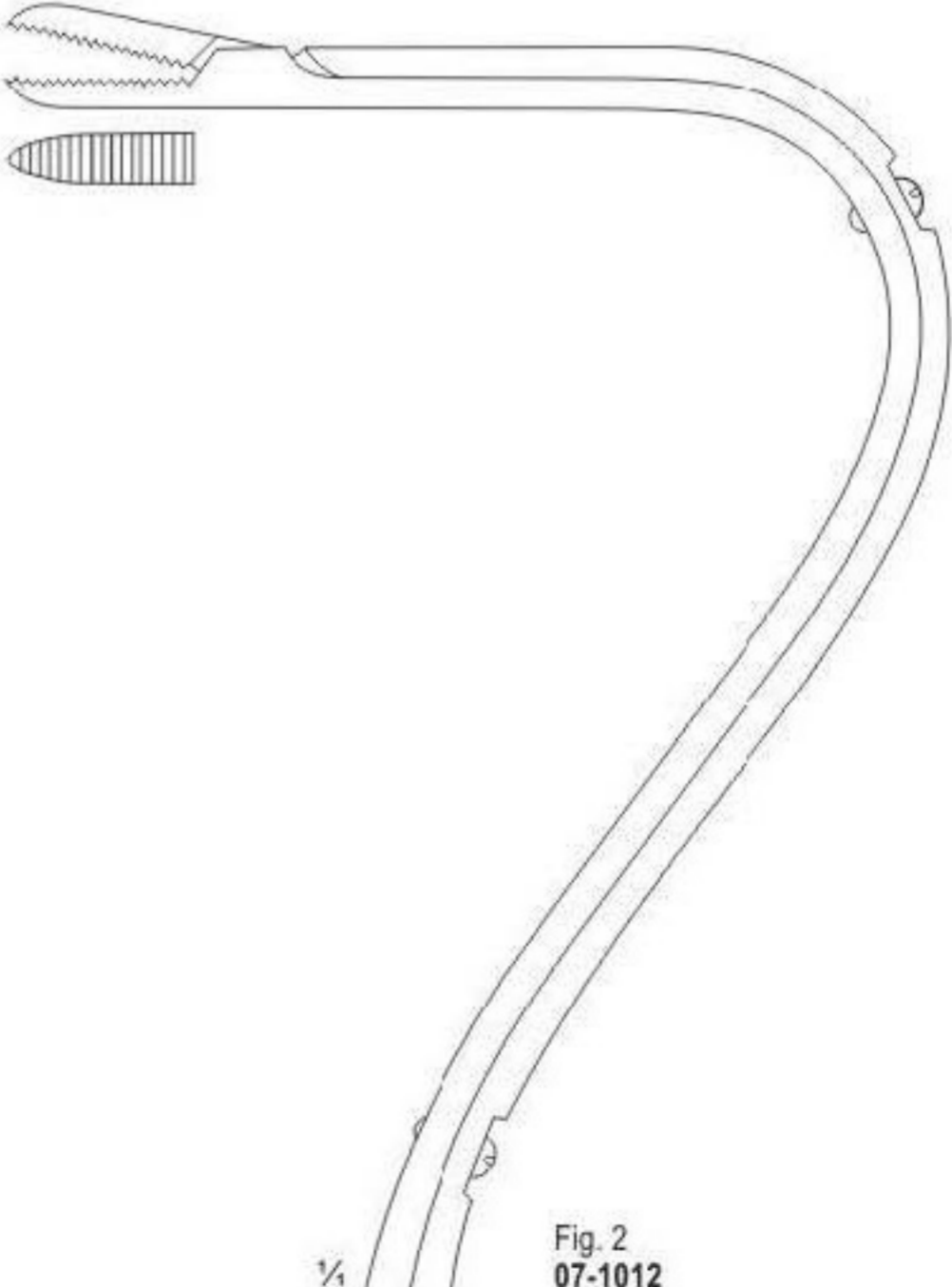
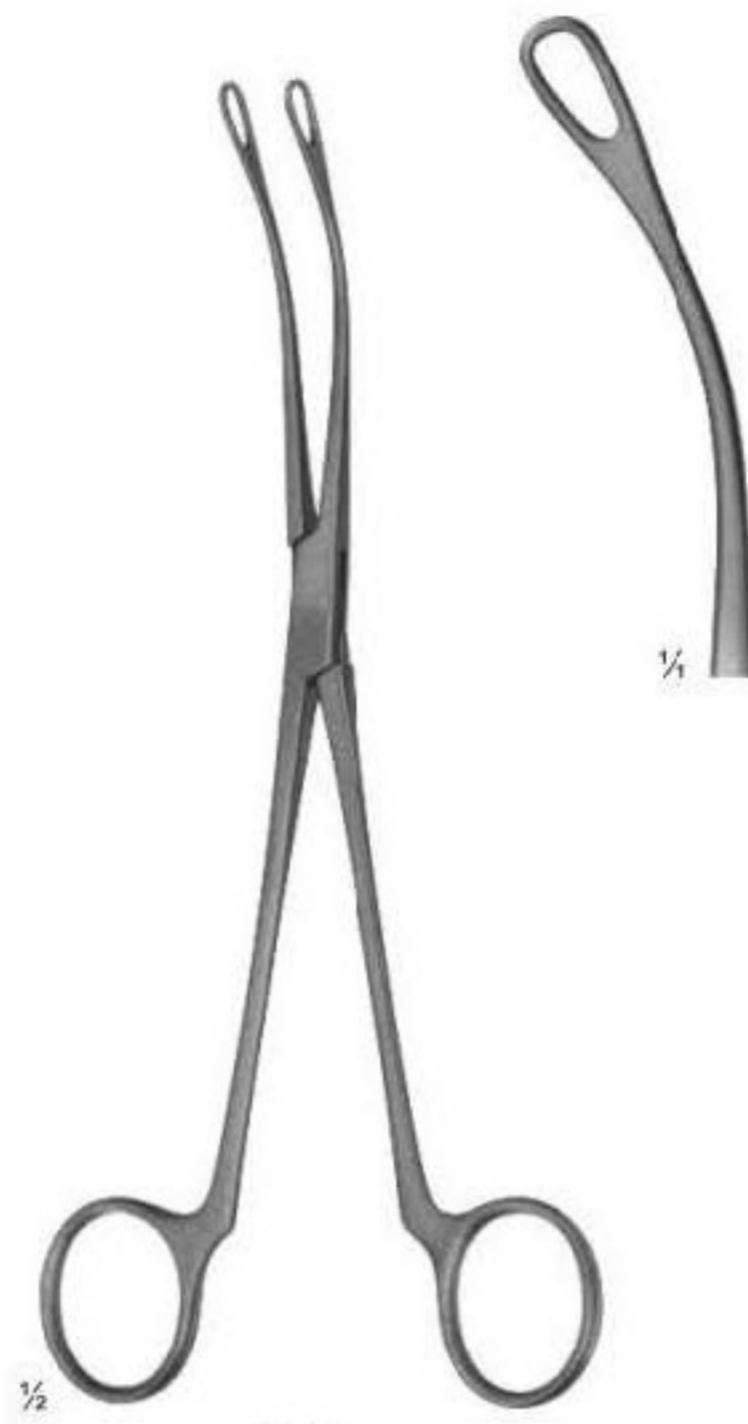

Fig. 2
07-1012

Gall Stone Forceps



BLAKE
07-1013
20.5 cm



BLAKE
07-1014
20.5 cm



MAYO-BLAKE
07-1015
21 cm



MAYO-BLAKE
07-1016
21 cm

Gall Stone Forceps

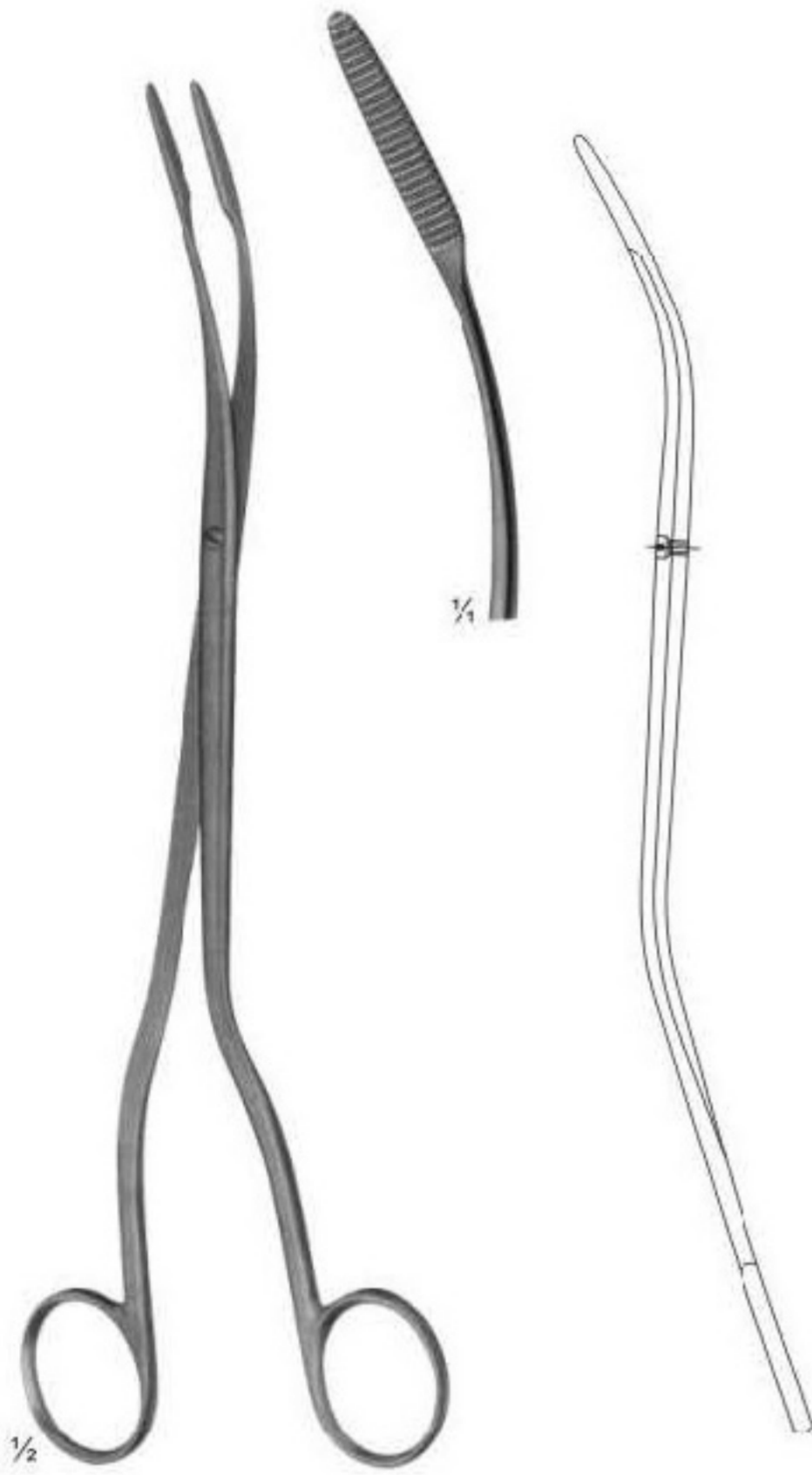

CZERNY
07-1017
24.5 cm

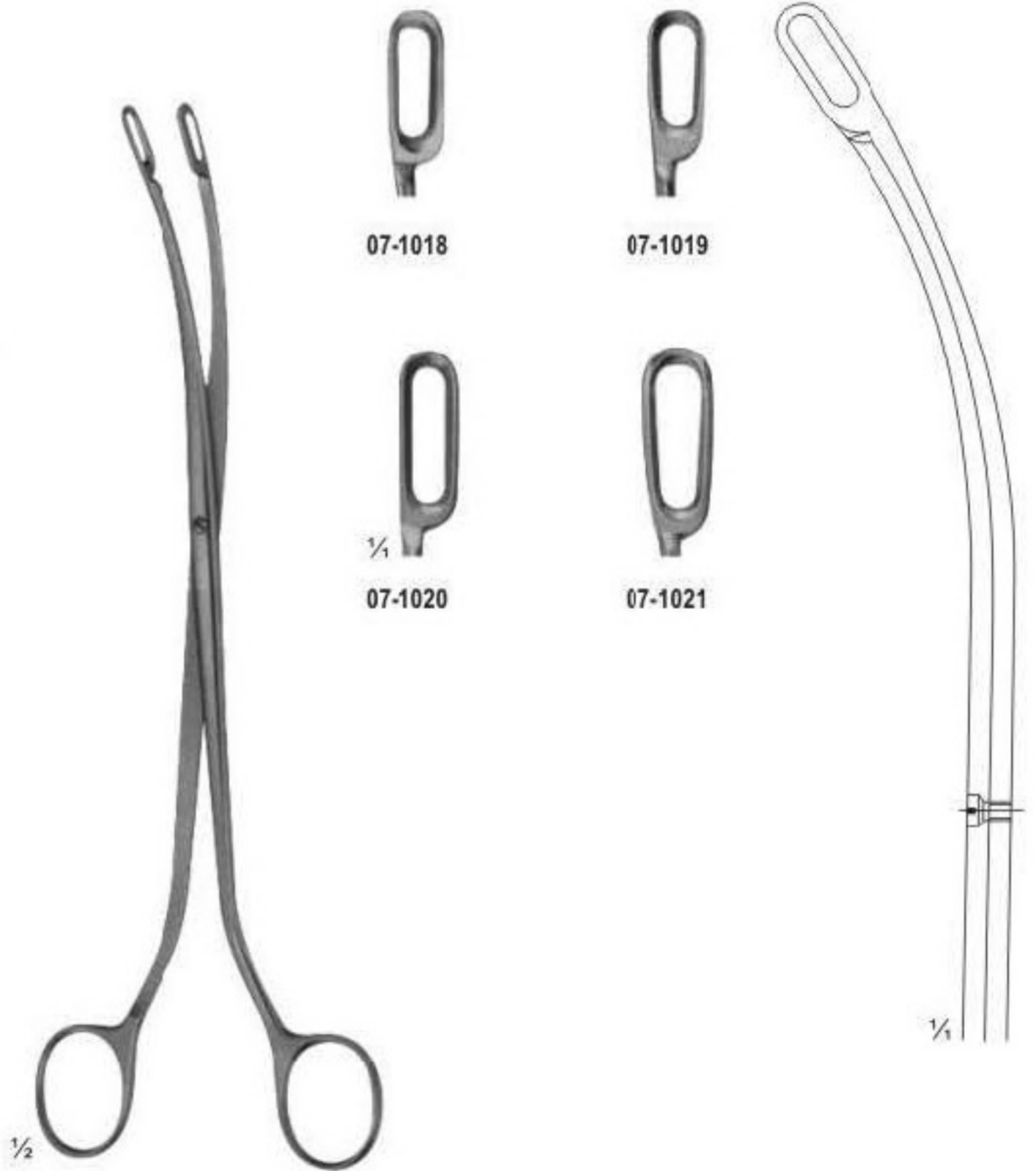

DESJARDINS
07-1018 - 07-1021
22.5 cm

Gall Stone, Capsule Forceps



DESJARDINS
Extremely delicate patterns
07-1022 - 07-1023



07-1022
24 cm



07-1023
22.5 cm



MILLIN
07-1024
23 cm

Gall Stone, Capsule Forceps

ATRAUMA



MILLIN
Lobe grasping forceps
07-1025
23.5 cm

ATRAUMA



MILLIN
Lobe grasping forceps
07-1026
24.5 cm



MILLIN
Ligature holding forceps
07-1027
24.5 cm

Kidney Stone Forceps



$\frac{1}{2}$
MILLIN
07-1030
Bladder neck spreader
28.5 cm



$\frac{1}{2}$
YOUNG
07-1028
20 cm



$\frac{1}{2}$
SPERMATIC
07-1029
14.5 cm



$\frac{1}{2}$
07-1031
Ureter forceps
24 cm

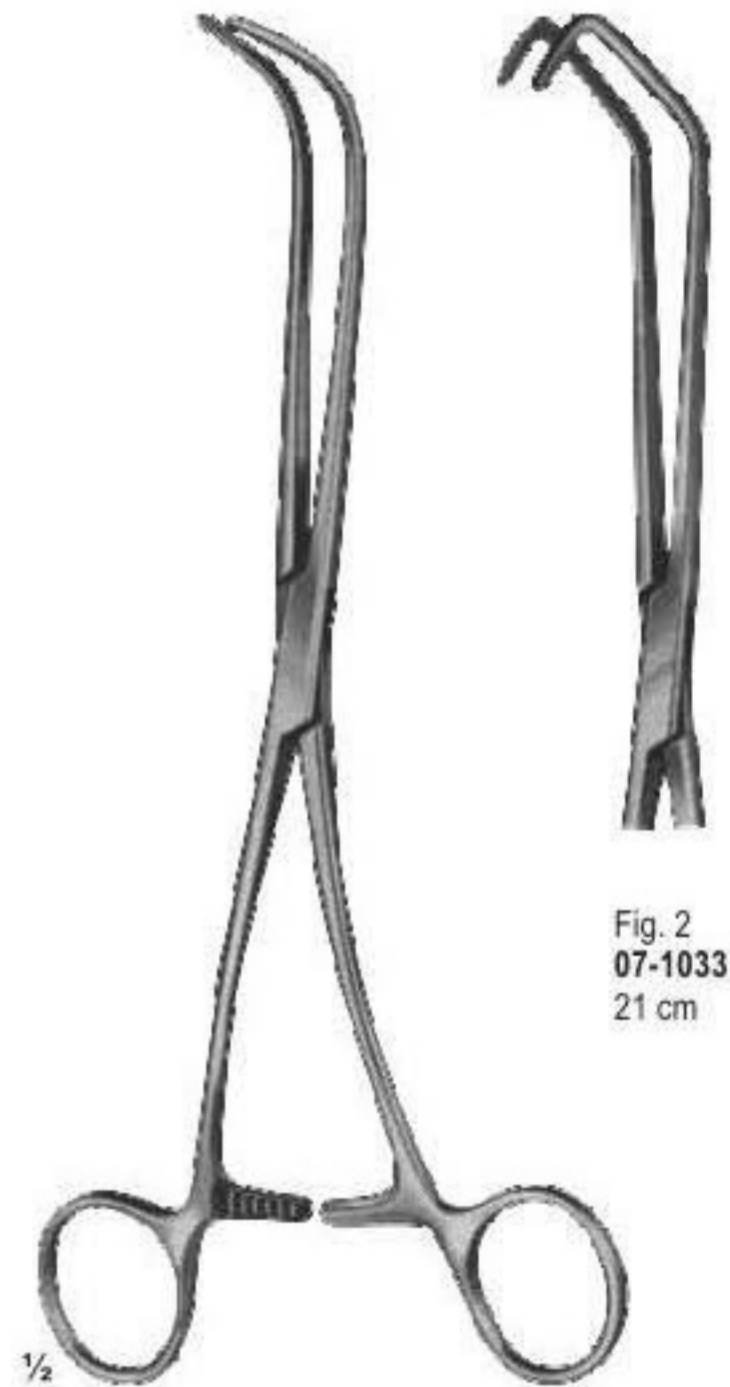

$\frac{1}{2}$
LURZ
Fig. 1
07-1032
21 cm

Fig. 2
07-1033
21 cm

Bladder Retractors



LEGUEU
07-1034
27 cm



KOCHER
07-1035
26 cm



KOCHER
07-1036
26 cm

Prostatic Retractors

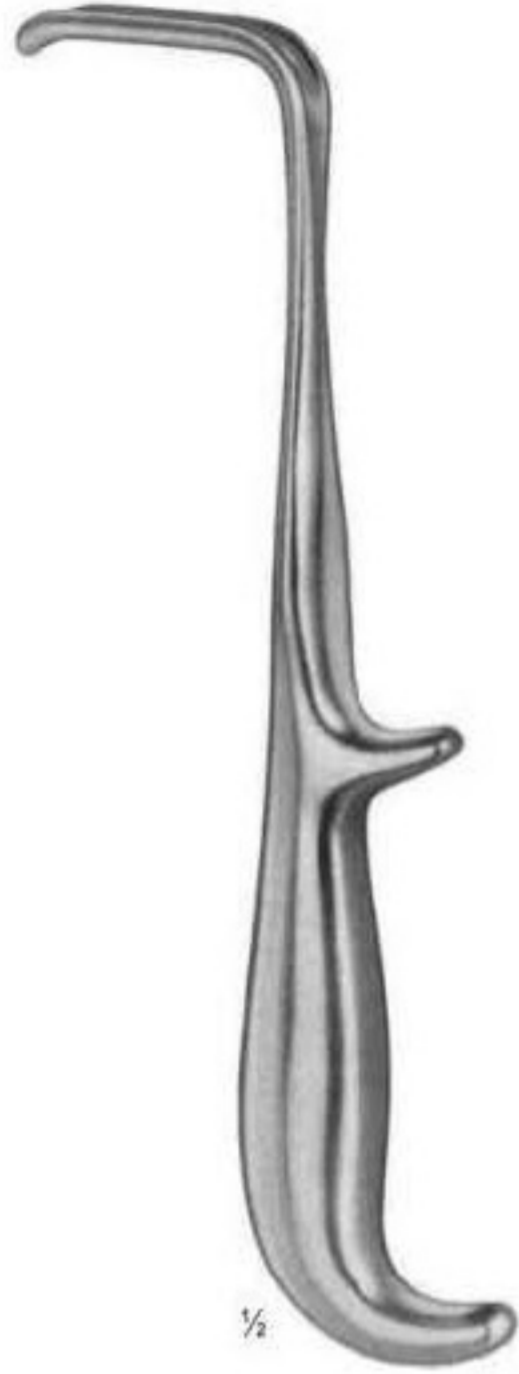

½

YOUNG
07-1037
21 cm



½

YOUNG
07-1038
22 cm



½

YOUNG
07-1039
21 cm



½

YOUNG
07-1040
22 cm



½

SPERMATIC
07-1041
16 cm

Bladder Retractors



JUDD-MASSON
07-1042
Spreading



LEGUEU
07-1043
Bladder retractor
Center blade
80 x 31 mm

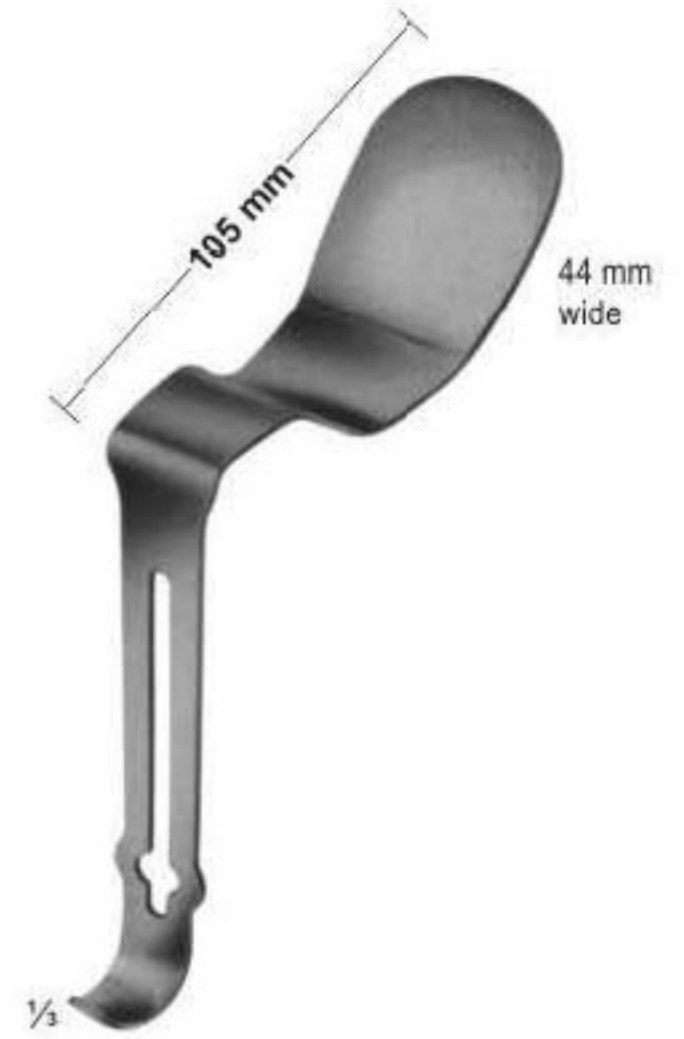

MILLIN
07-1044
Center bladder for
retro pubic prostatectomy



MILLIN
Bladder retractor
07-1045
105 X 45 mm



MILLIN
07-1046
Bladder retractor
with FIBER OPTIC

Bladder Retractors



JUDD-MASSON
07-1047
12 cm



JUDD-MASSON
07-1048
12 cm



$\frac{1}{2}$
MATHIEU
07-1049
Foreign body forceps
Length of shaft
19 cm

Gall Duct Dilators & Gall Stone Scoops



- 07-1050 8
- 07-1051 9
- 07-1052 10
- 07-1053 11
- 07-1054 12
- 07-1055 13
- 07-1056 14
- 07-1057 15
- 07-1058 16
- 07-1059 17
- 07-1060 18
- 07-1061 19
- 07-1062 20
- 07-1063 21
- 07-1064 22
- 07-1065 23
- 07-1066 24
- 07-1067 25
- 07-1068 26
- 07-1069 27
- 07-1070 28
- 07-1071 29
- 07-1072 30

DITTEL
Metall bougies and dilating sounds, stiff
07-1050 - 07-1072
34.5 cm

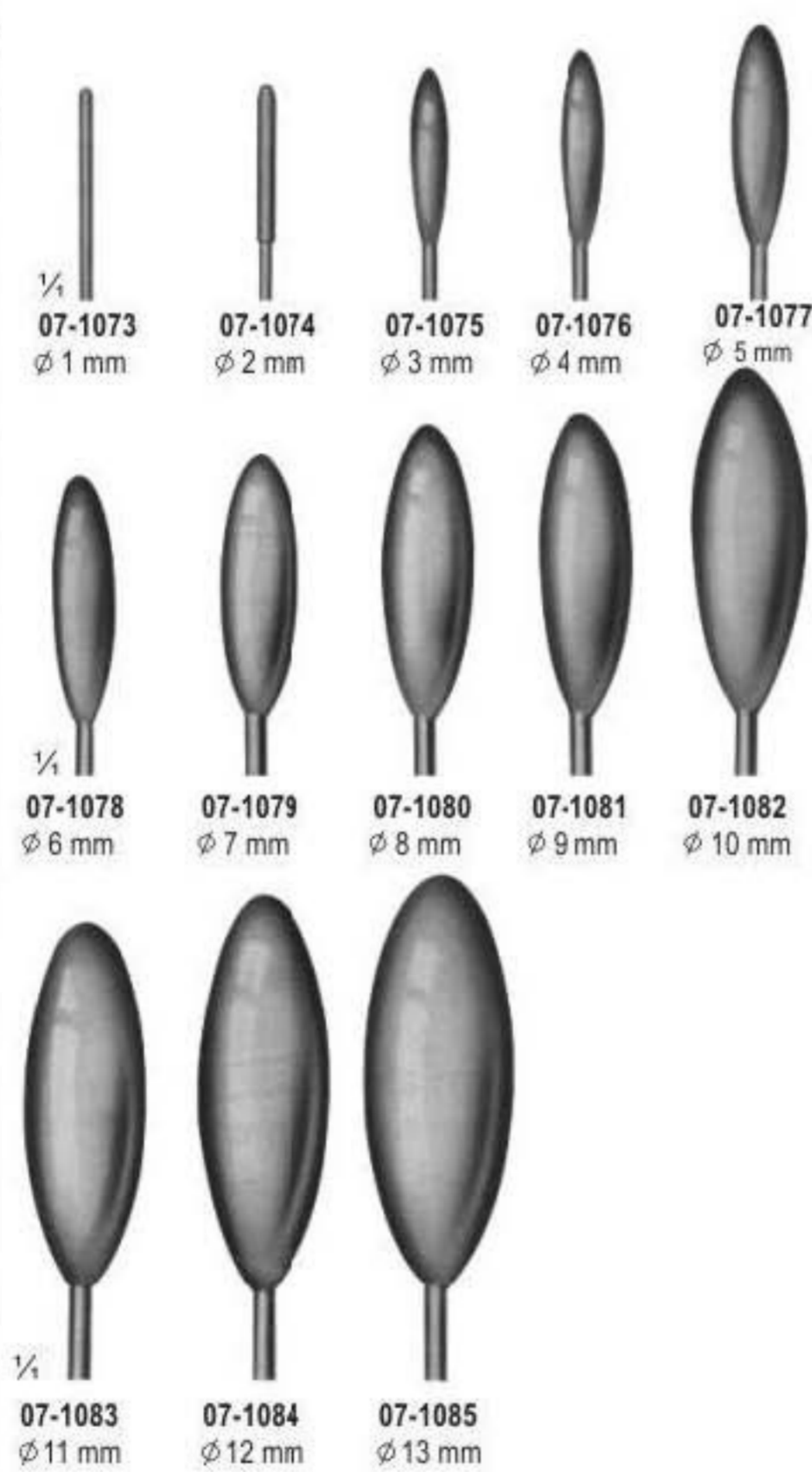

BAKES
Common bile duct dilators, malleable
07-1073 - 07-1085
32 cm

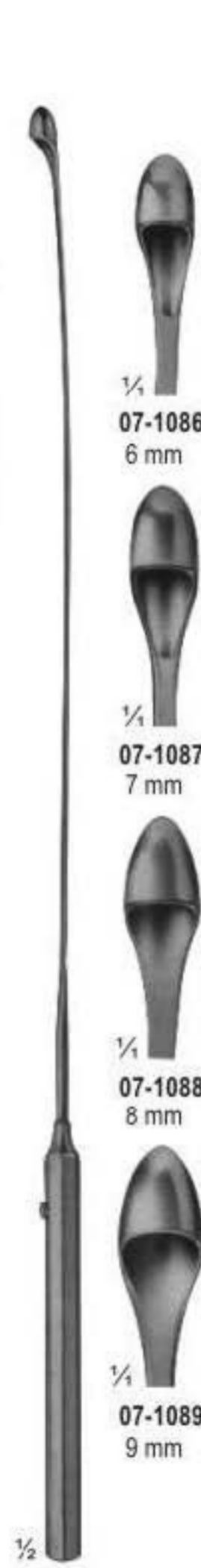

DESJARDINS
Probes and catch with flexible shaft
07-1086 - 07-1089
30 cm

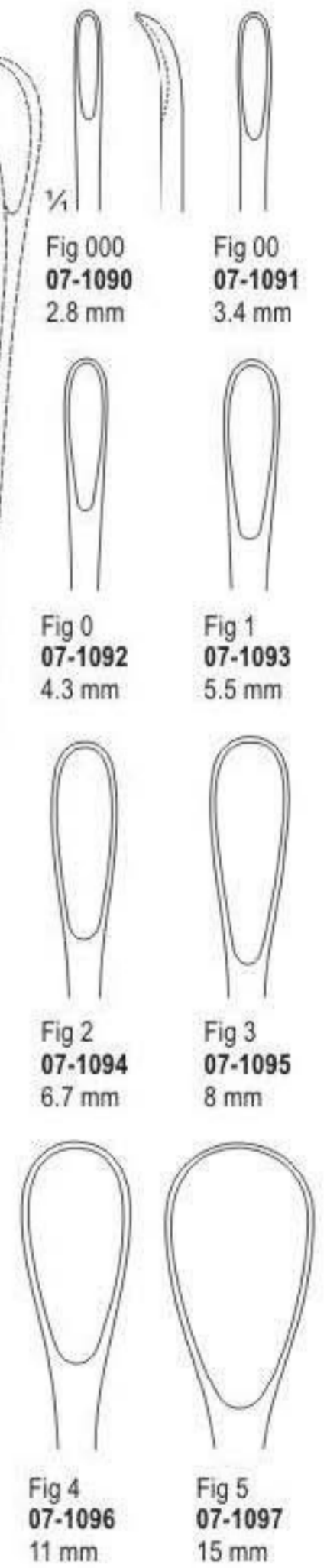
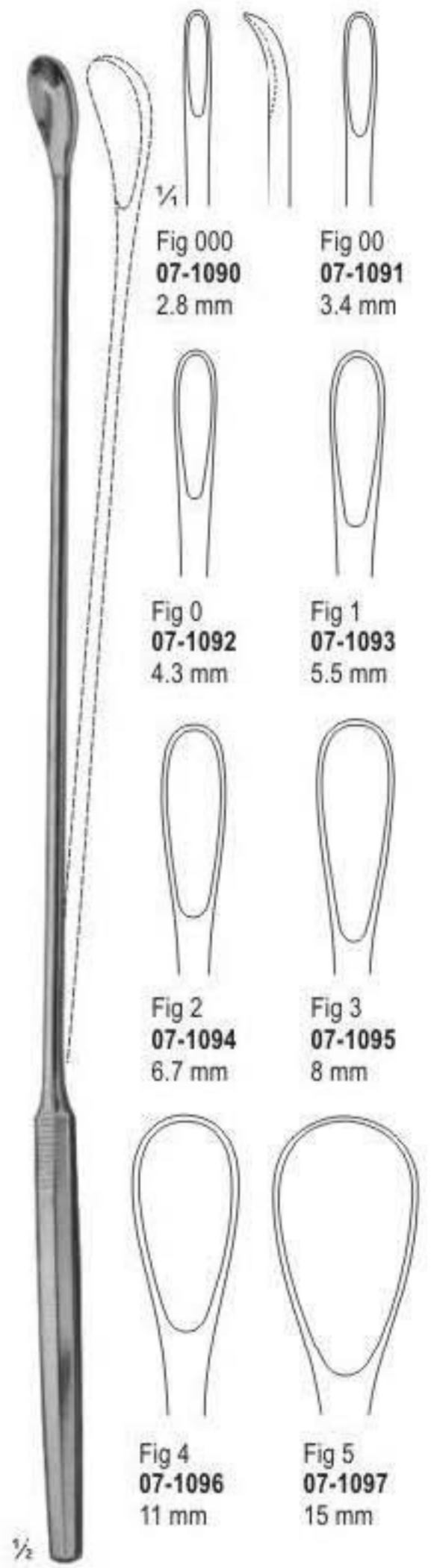

LUER-KORTE modif
with malleable shaft
07-1090 - 07-1097
31 cm

Gall Duct Probes

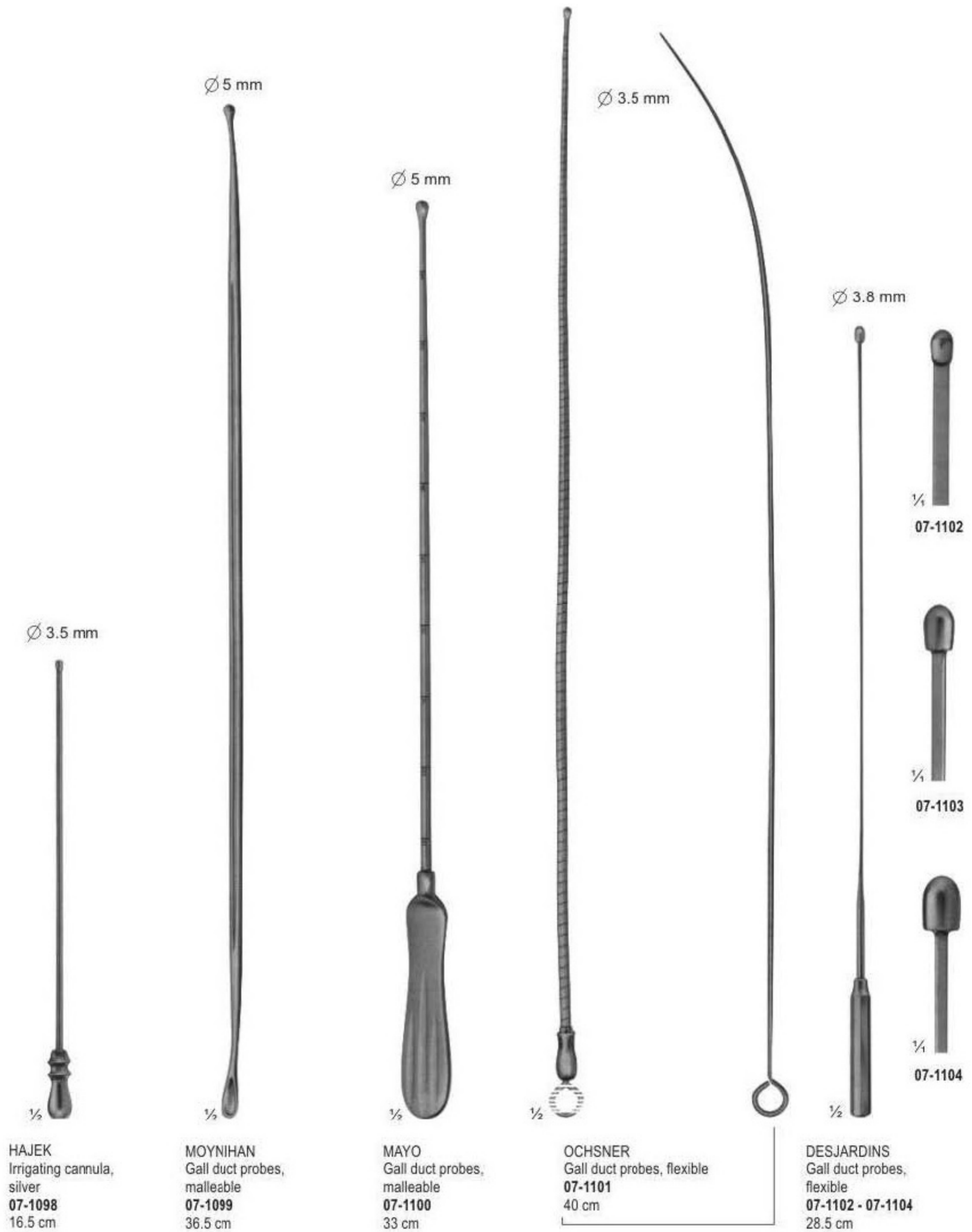

Genito-urinary Instruments



GUYON
Catheter guide
(introducer)
07-1105
36.5 cm

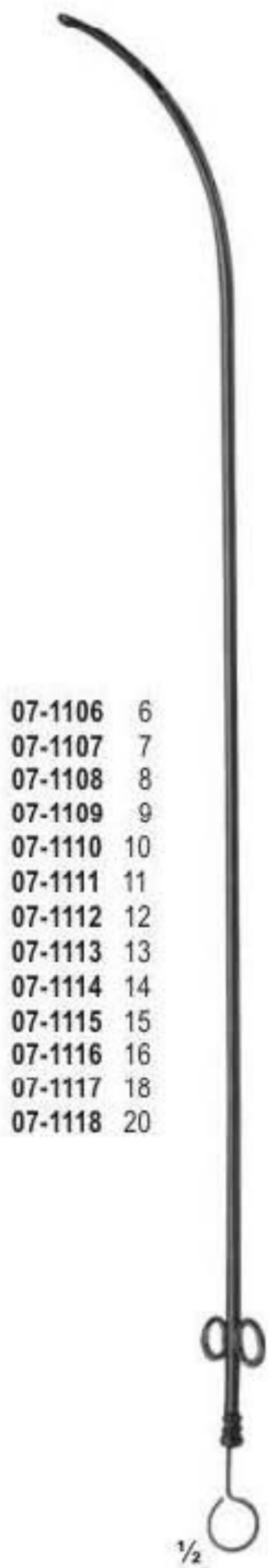

- 07-1106 6
- 07-1107 7
- 07-1108 8
- 07-1109 9
- 07-1110 10
- 07-1111 11
- 07-1112 12
- 07-1113 13
- 07-1114 14
- 07-1115 15
- 07-1116 16
- 07-1117 18
- 07-1118 20

Female catheters,
metal
07-1106 - 07-1118
16 cm



- 07-1119 8
- 07-1120 9
- 07-1121 10
- 07-1122 11
- 07-1123 12
- 07-1124 13
- 07-1125 14
- 15-225-15 15
- 15-226-16 16
- 15-227-17 17
- 15-228-18 18
- 15-229-19 19
- 15-230-20 20
- 15-231-21 21
- 15-232-22 22
- 15-233-23 23
- 15-234-24 24
- 15-235-25 25
- 15-236-26 26
- 15-237-27 27
- 15-238-28 28
- 15-239-29 29
- 15-240-30 30

Urethral bougies
and dilating sounds
15-218-08 - 15-240-30
34.5 cm

- 15-241-25 Ben. 24/Charr. 12
- 15-242-25 Ben. 25
- 15-243-25 Ben. 26/Charr. 13
- 15-244-25 Ben. 27
- 15-245-25 Ben. 28/Charr. 14
- 15-246-25 Ben. 29
- 15-247-25 Ben. 30/Charr. 15
- 15-248-25 Ben. 31
- 15-249-25 Ben. 32/Charr. 16
- 15-250-25 Ben. 33
- 15-251-25 Ben. 34/Charr. 17
- 15-252-25 Ben. 35
- 15-253-25 Ben. 36/Charr. 18
- 15-254-25 Ben. 37
- 15-255-25 Ben. 38/Charr. 19
- 15-256-25 Ben. 39
- 15-257-25 Ben. 40/Charr. 20
- 15-258-25 Ben. 41
- 15-259-25 Ben. 42/Charr. 21
- 15-260-25 Ben. 43
- 15-261-25 Ben. 44/Charr. 22
- 15-262-25 Ben. 45
- 15-263-25 Ben. 46/Charr. 23
- 15-264-25 Ben. 47
- 15-265-25 Ben. 48/Charr. 24
- 15-266-25 Ben. 49
- 15-267-25 Ben. 50/Charr. 25
- 15-268-25 Ben. 51
- 15-269-25 Ben. 52/Charr. 26
- 15-270-25 Ben. 53
- 15-271-25 Ben. 54/Charr. 27
- 15-272-25 Ben. 55
- 15-273-25 Ben. 56/Charr. 28
- 15-274-25 Ben. 57
- 15-275-25 Ben. 58/Charr. 29
- 15-276-25 Ben. 59
- 15-277-25 Ben. 60/Charr. 30

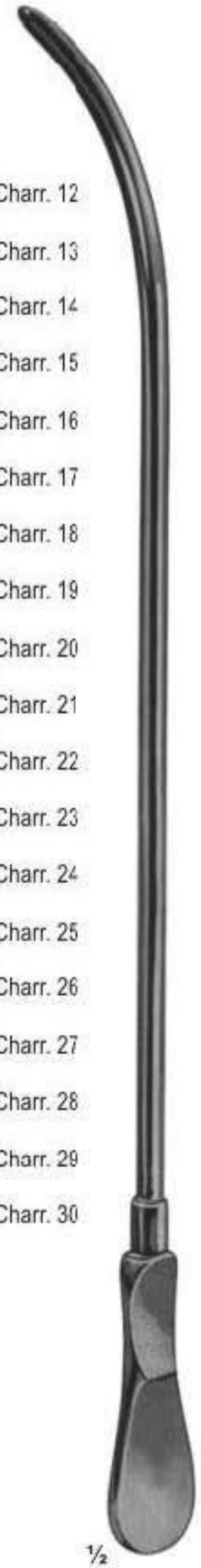

Urethral bougies
and dilating sounds
15-241-25 - 15-277-25
25.5 cm

Page 175-183

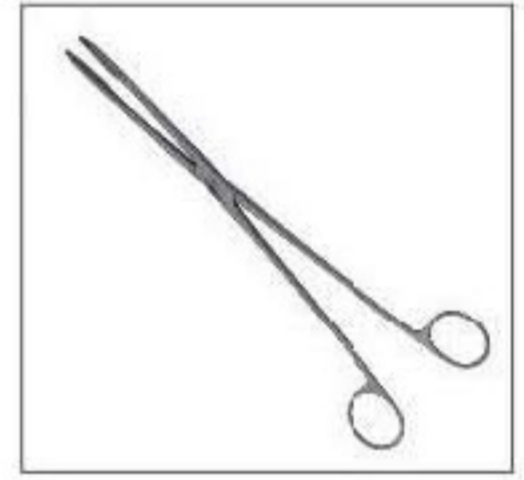
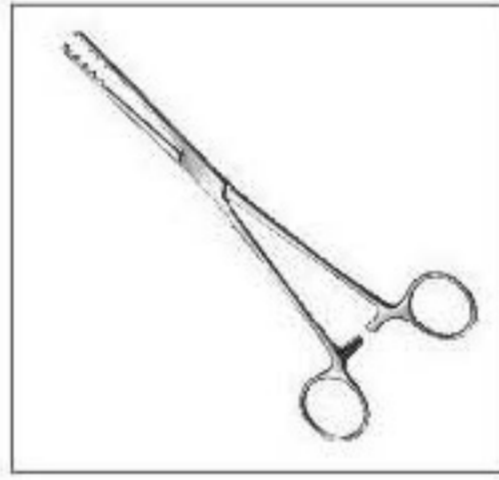
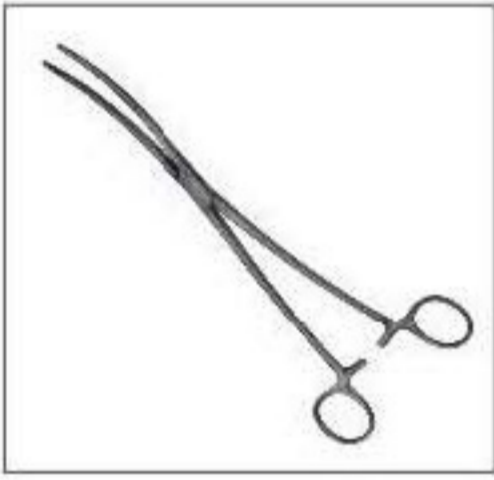

- Dressing Forceps
- Sponge & Dressing Forceps
- Sponge Forceps
- Uterine Dressing Forceps
- Tendon Seizing Forceps



Sponge Forceps

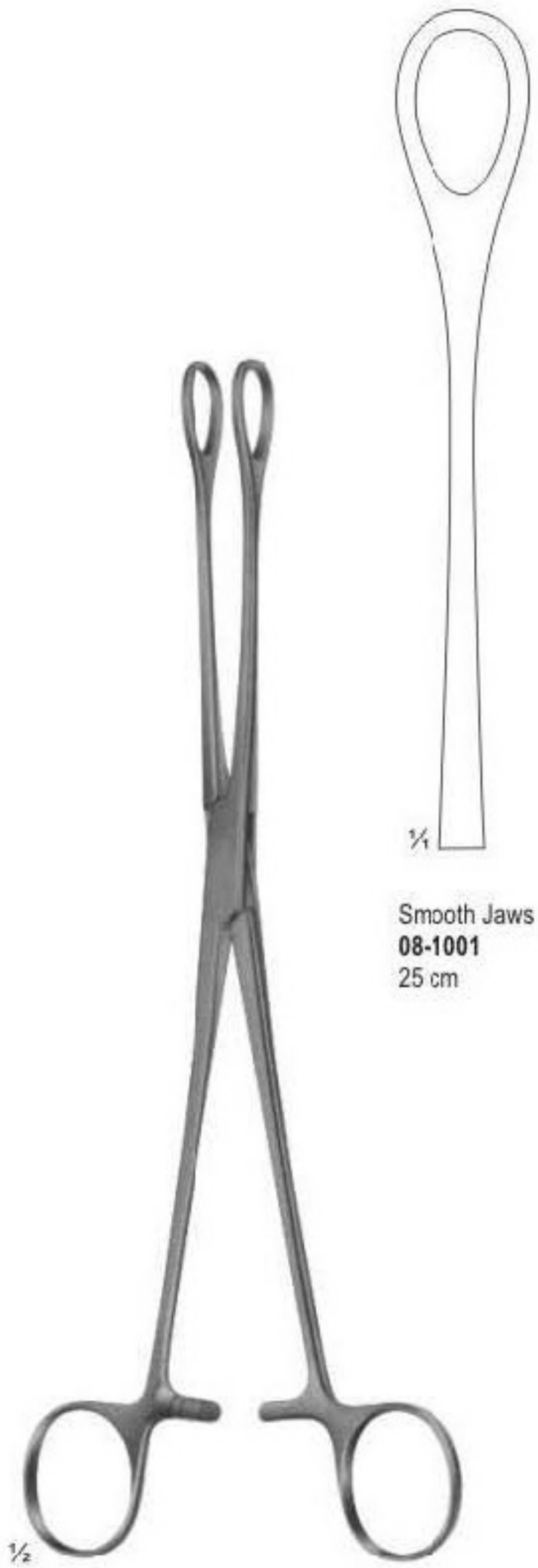

Smooth Jaws
08-1001
25 cm



Smooth Jaws
08-1002
25 cm



FÖRSTER
08-1003 - 08-1004

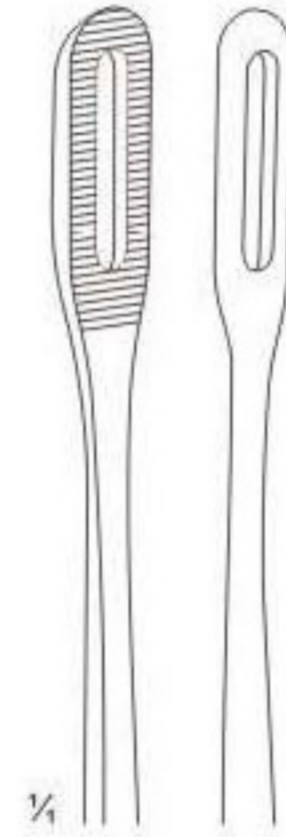

08-1003
25 cm

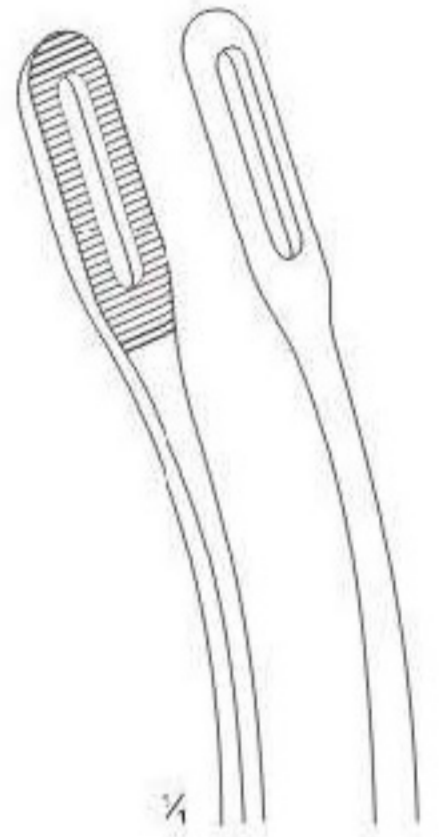

08-1004
25 cm

Sponge Forceps



BERGMANN
08-1005
24 cm



RAMPLEY
08-1006 - 08-1007



08-1006
18 cm



08-1007
25 cm

Dressing Forceps



ULRICH
08-1008
22.5 cm

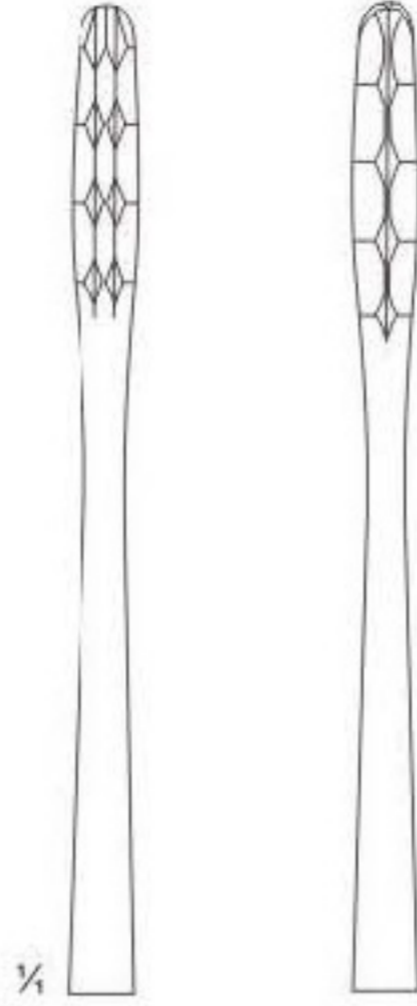

ULRICH
08-1009
22.5 cm

Dressing Forceps



ULRICH
08-1010
26.5 cm

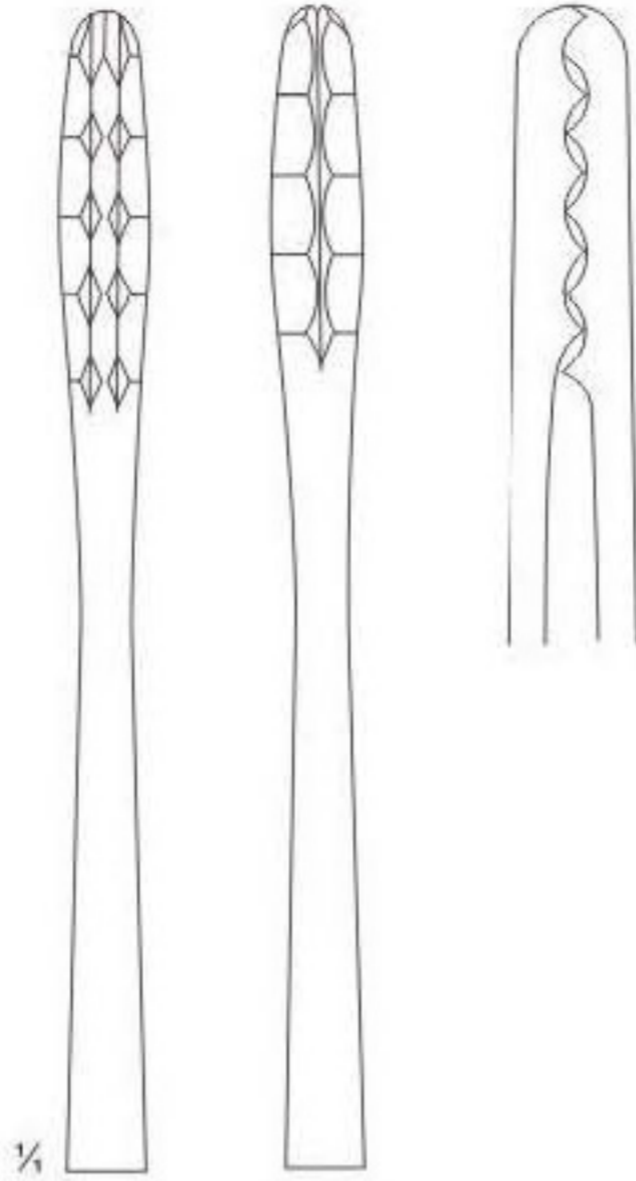

ULRICH
08-1011
26.5 cm

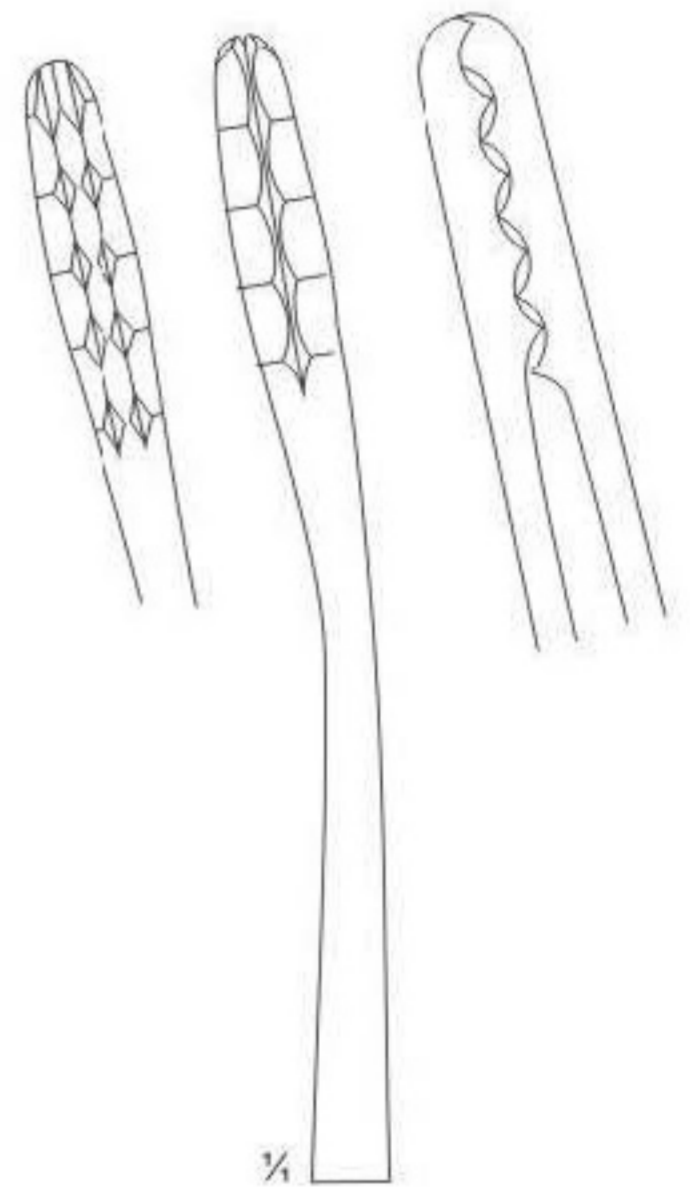

Dressing Forceps



FOERSTER-BALLENGER
08-1012 - 08-1017

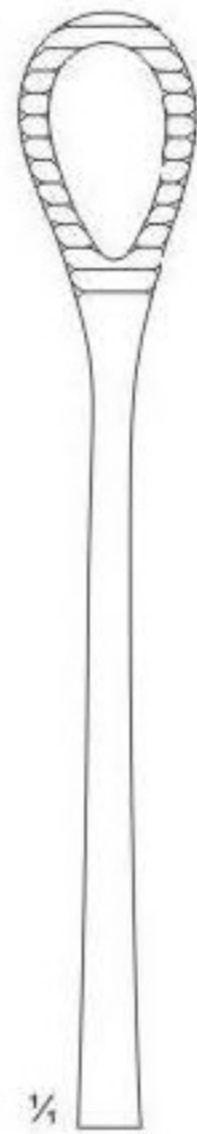

Serrated Jaws
08-1012 18 cm
08-1013 20.5 cm
08-1014 25 cm



Serrated Jaws
08-1015 18 cm
08-1016 20.5 cm
08-1017 25 cm

Sponge And Dressing Forceps

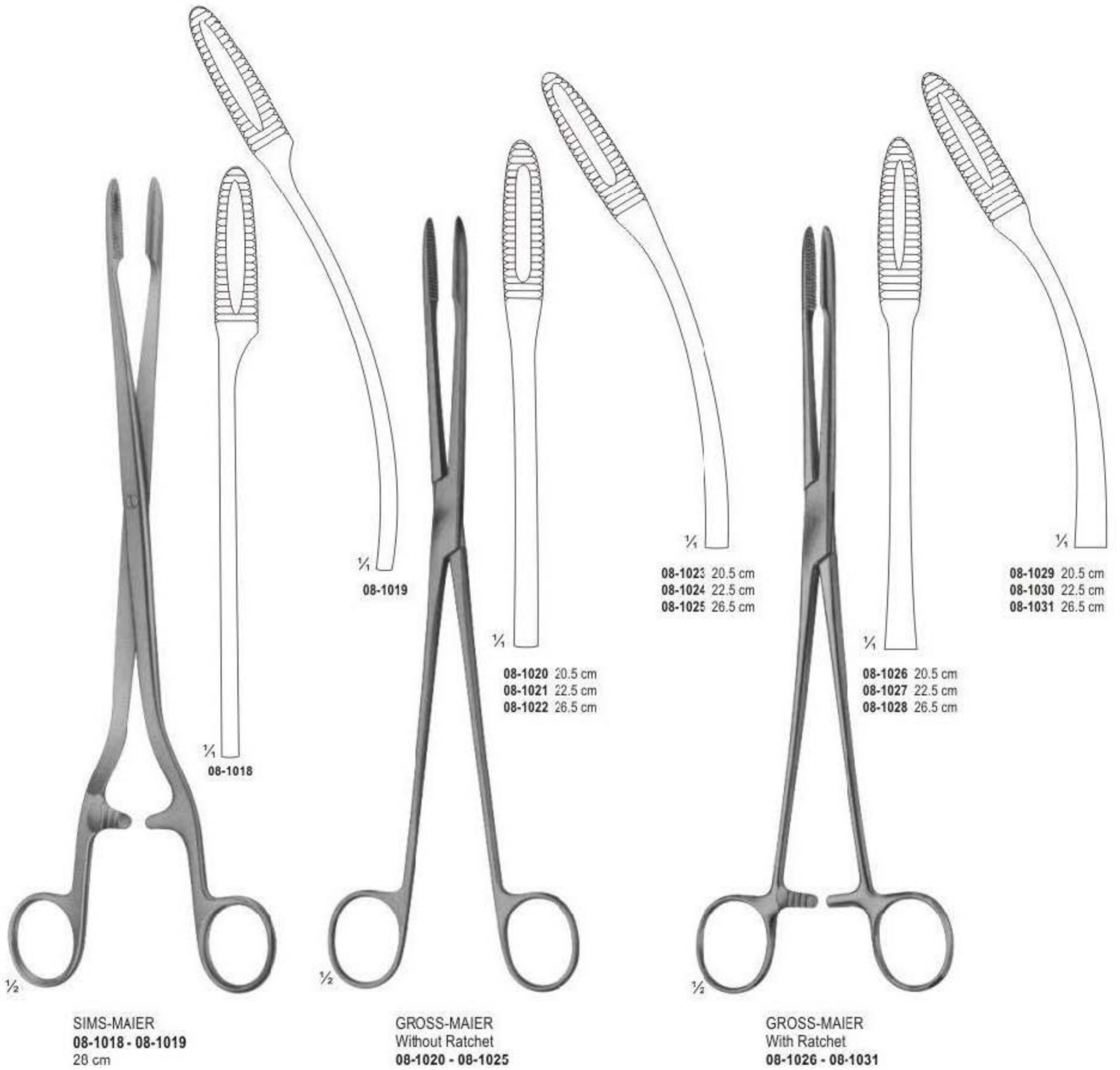

Sponge And Dressing Forceps

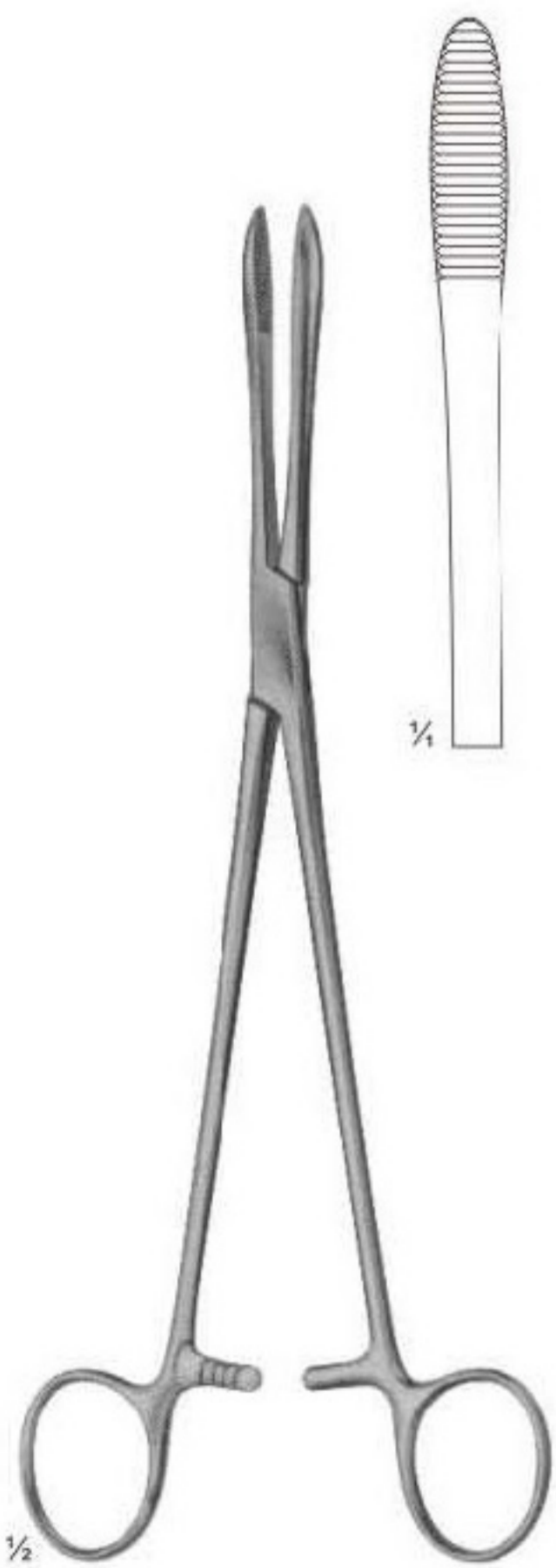

COLLIN
08-1032
24 cm

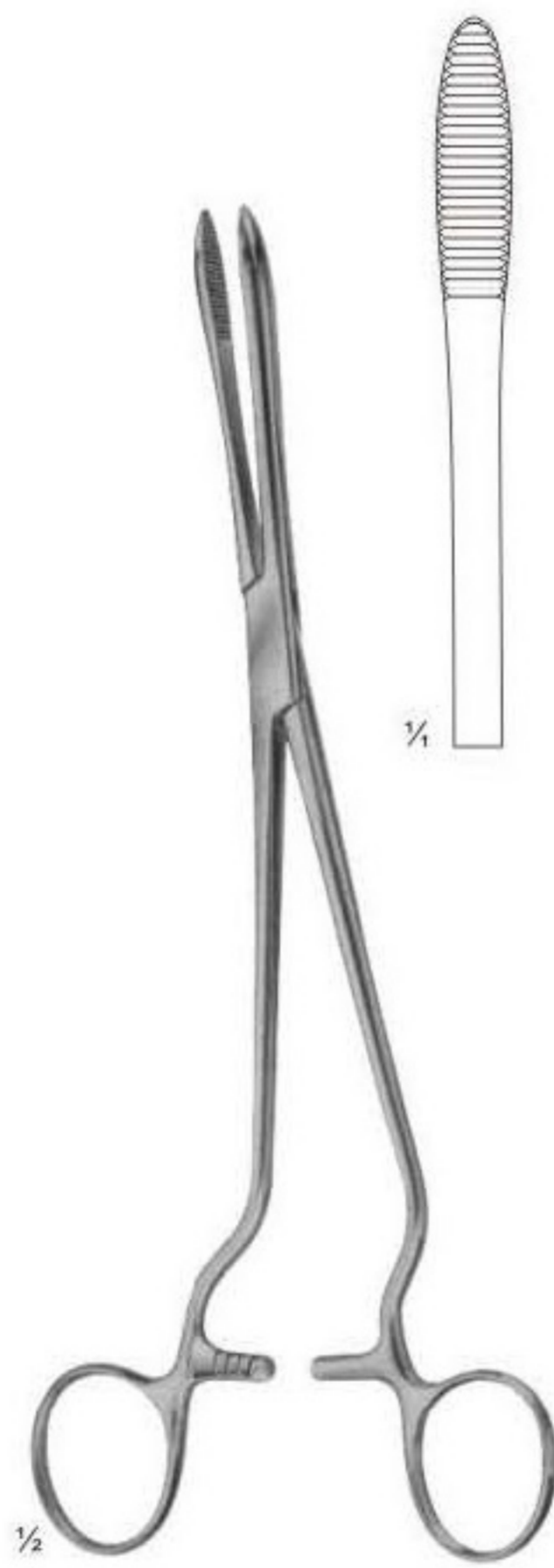

CHERON
08-1033
24 cm

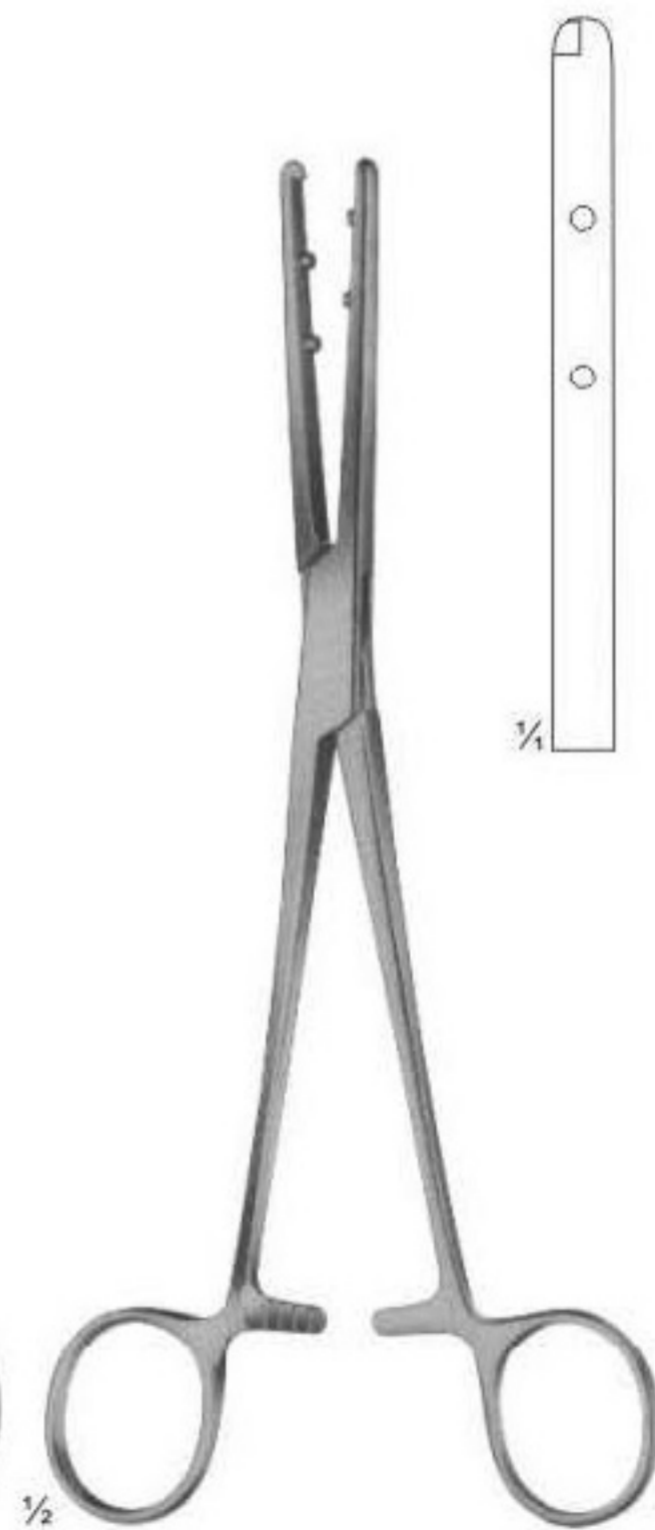

EMMET
08-1034
21 cm

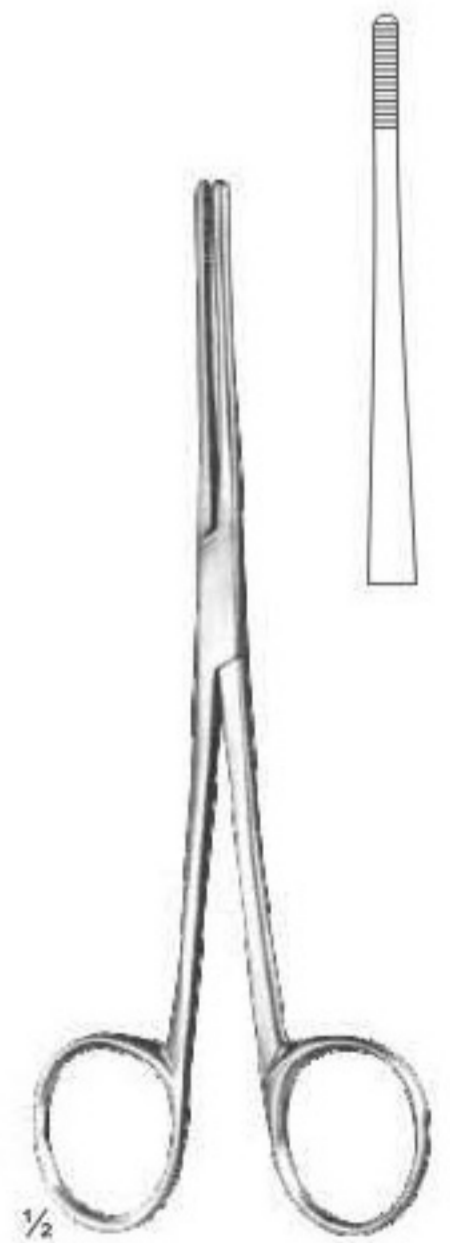

LISTER
08-1035 - 08-1037
08-1035 13 cm
08-1036 16 cm
08-1037 18.5 cm

Uterine Dressing Forceps



PELKMANN
08-1038
26 cm



PELKMANN
08-1039
26 cm



BOZEMANN
08-1040
25 cm



BOZEMANN
08-1041
25.5 cm

Tendon Seizing Forceps

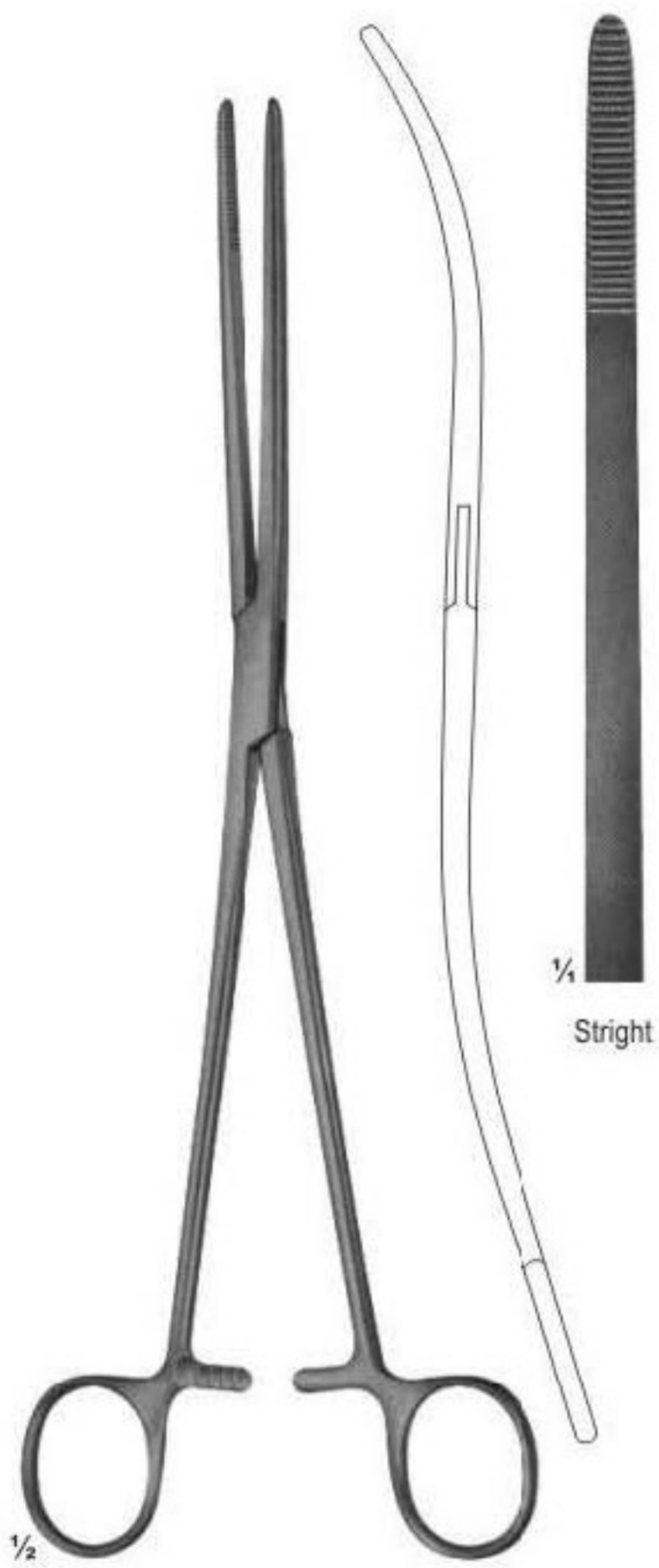

BOZEMANN
08-1042 - 08-1043
08-1042 26 cm
08-1043 25 cm

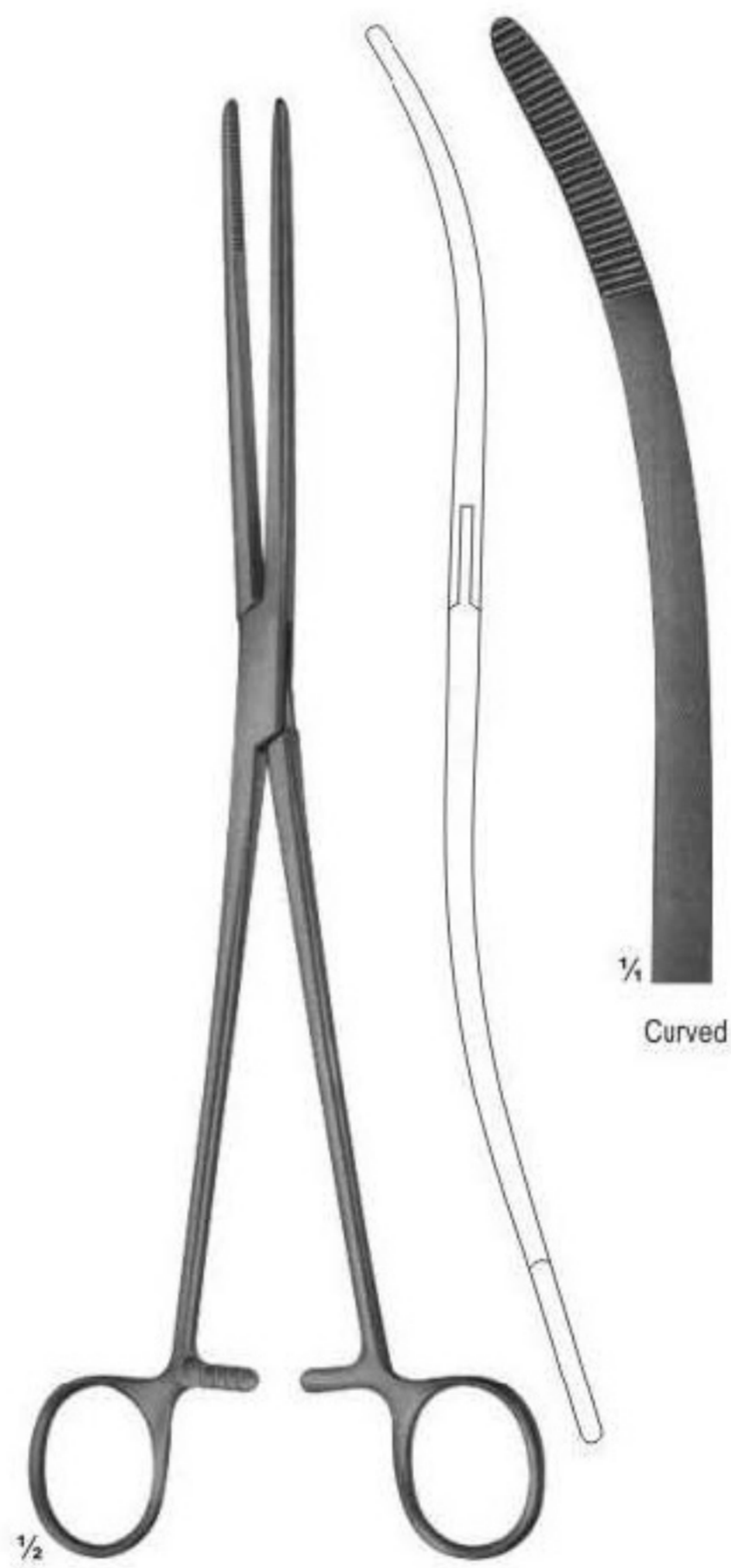

BOZEMANN
08-1044 - 08-1045
08-1044 26 cm
08-1045 25 cm



BOZEMANN-DOUGLAS
08-1046
26 cm

Page 184-214

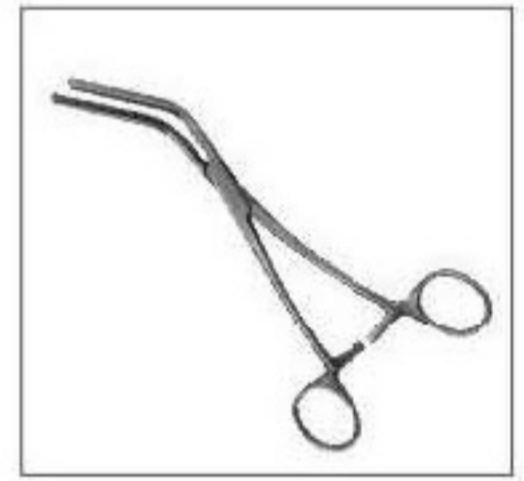
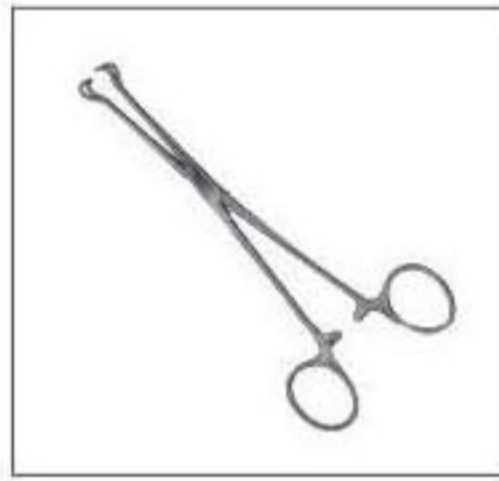

- Intestinal & Tissue Grasping Forceps
- Intestinal Clamps, Soft Elastic
- Sigmoid Anastomosis Forceps
- Gastro-intestinal Forceps, Twin
- Stomach Clamps
- Pylorus Clamps
- Intestinal Anastomosis Clamps
- Rectal Speculums
- Rectal Spreaders
- Anusscopes-sphincteroscopes
- Hemorrhoidal Ligator
- Biopsy Forceps & Swab Holders
- Biopsy Forceps For Rectum
- Sigmoid Anastomosis Forceps
- Multi-purpose Clamps



Intestinal Grasping Forceps

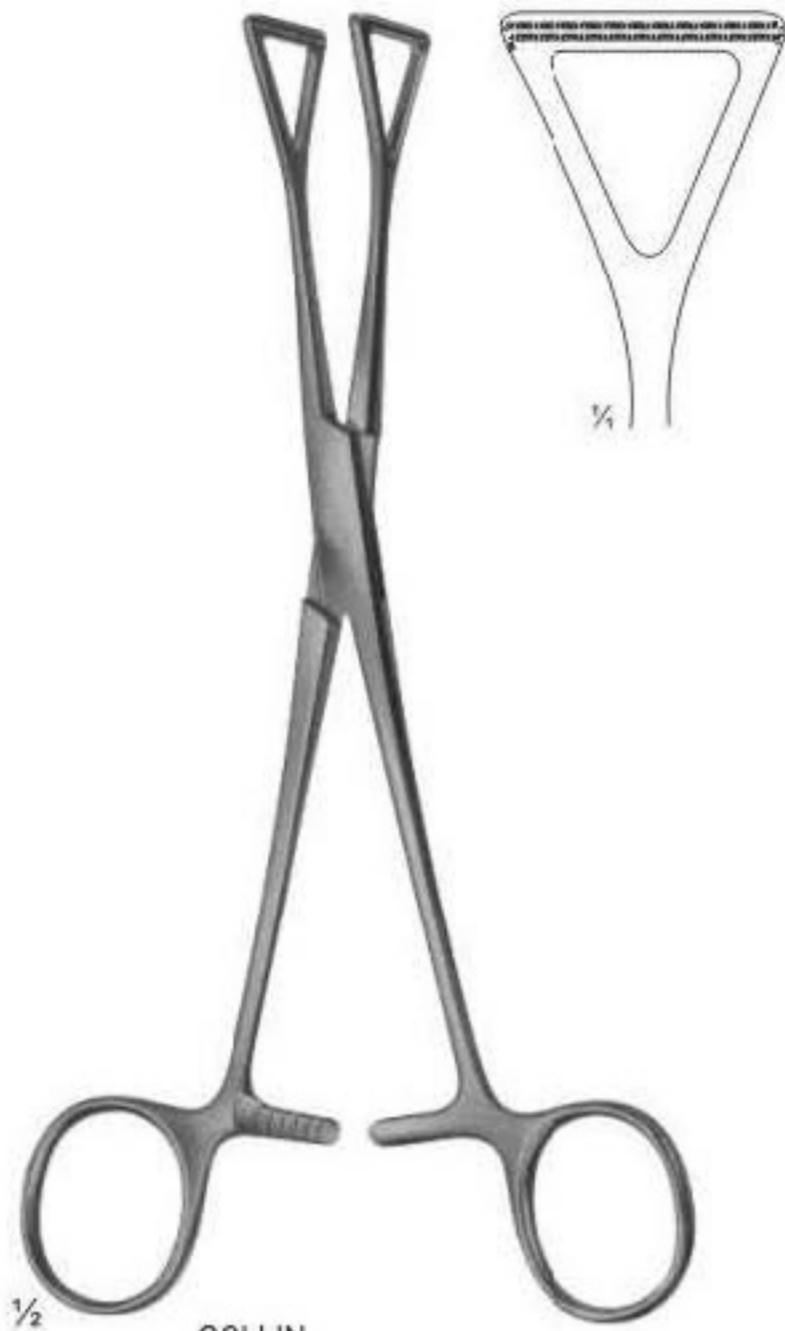

$\frac{1}{2}$
COLLIN
09-1001 - 09-1002
09-1001 19.5 cm
09-1002 23 cm



$\frac{1}{2}$
DUVAL-COLLIN
09-1003 - 09-1004
09-1003 19.5 cm
09-1004 20 cm



SCHEIBE
09-1005

ATRAUMA

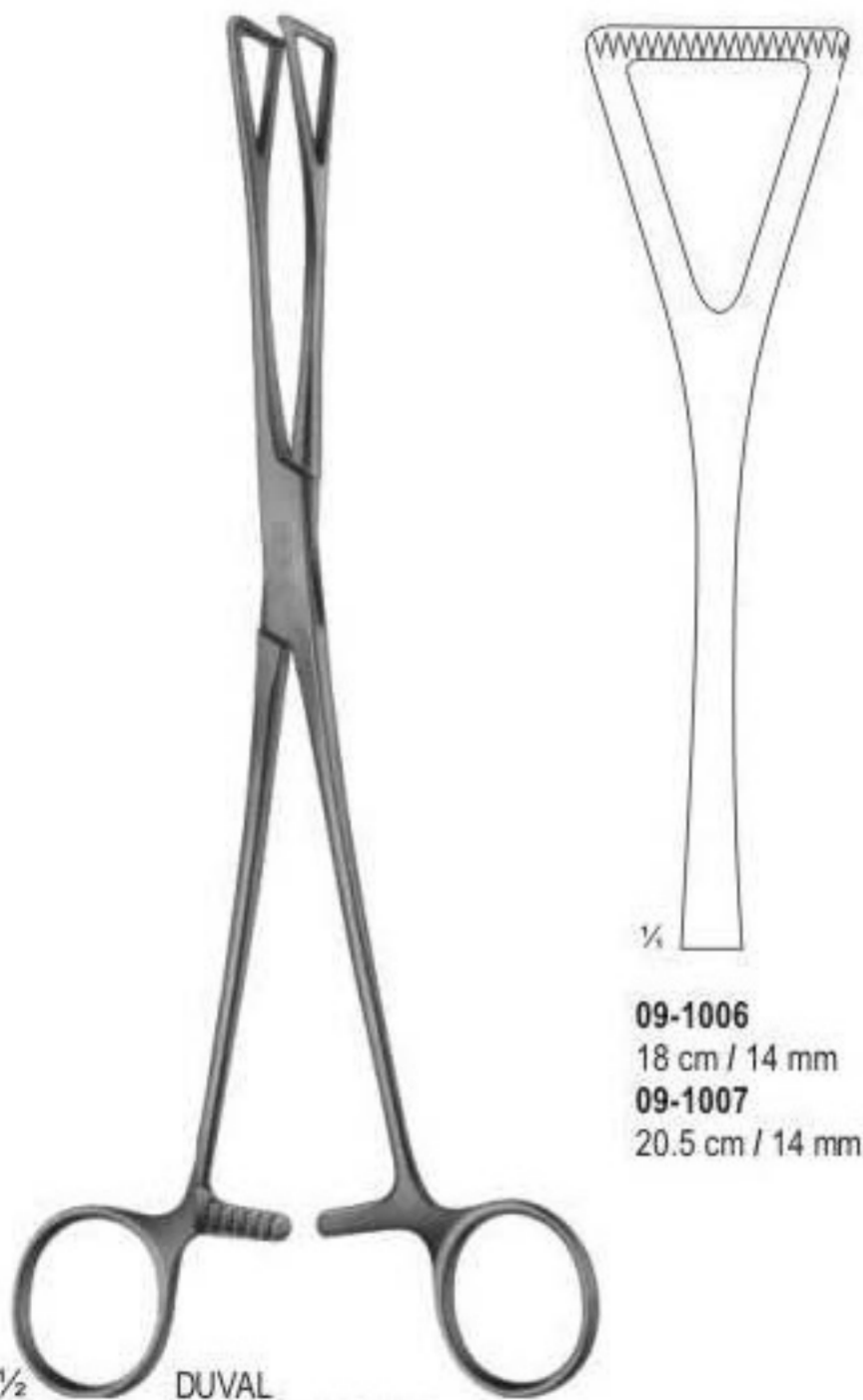

$\frac{1}{2}$
DUVAL
09-1006 - 09-1009

$\frac{1}{4}$
09-1006
18 cm / 14 mm
09-1007
20.5 cm / 14 mm

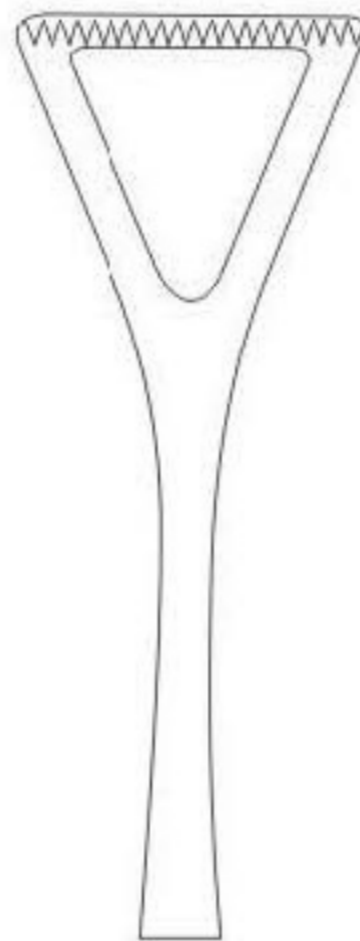

$\frac{1}{4}$
09-1008
20.5 cm / 25 mm
09-1009
23 cm / 25 mm

TC GOLD

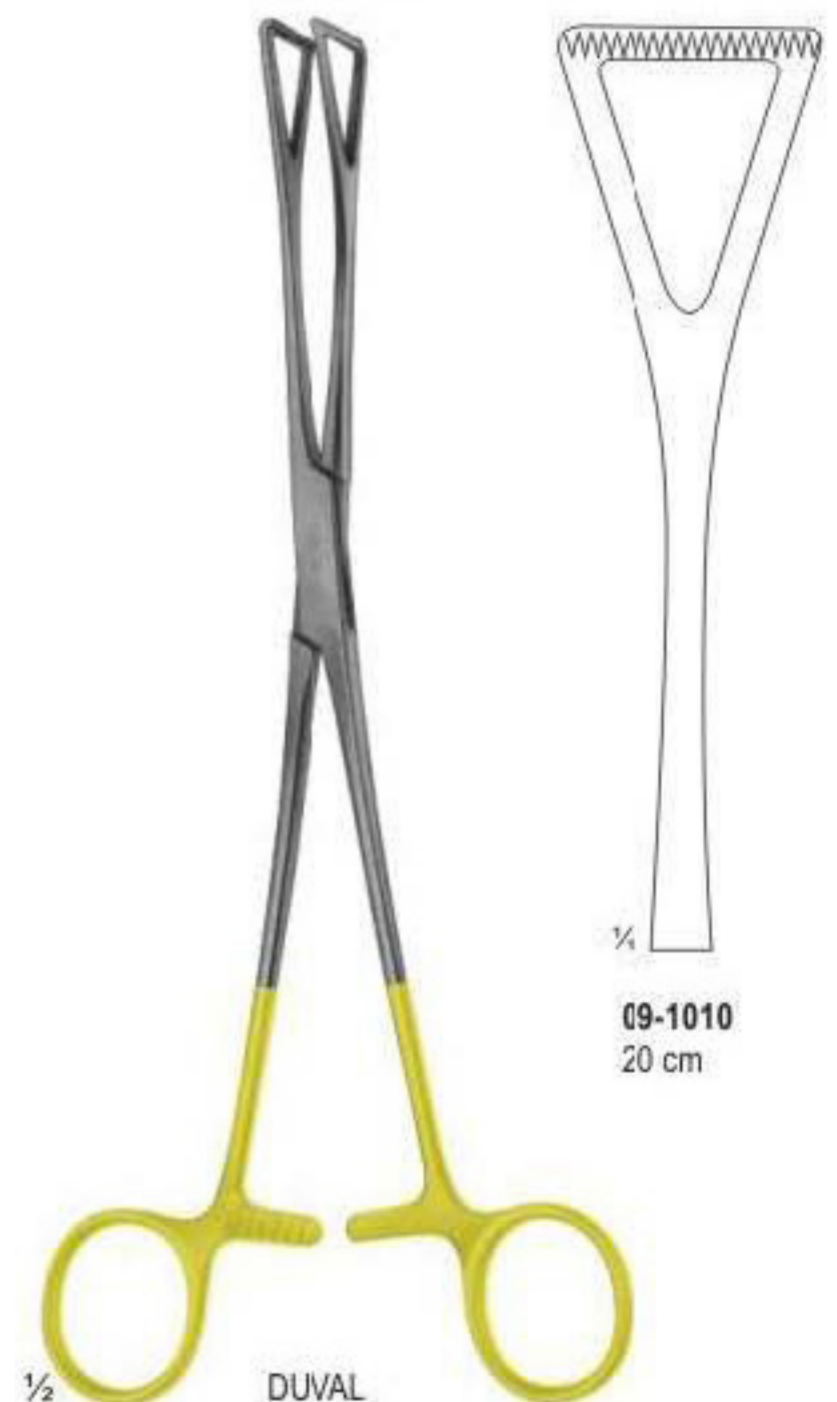

$\frac{1}{2}$
DUVAL
09-1010

$\frac{1}{4}$
09-1010
20 cm

Intestinal And Tissue Grasping Forceps

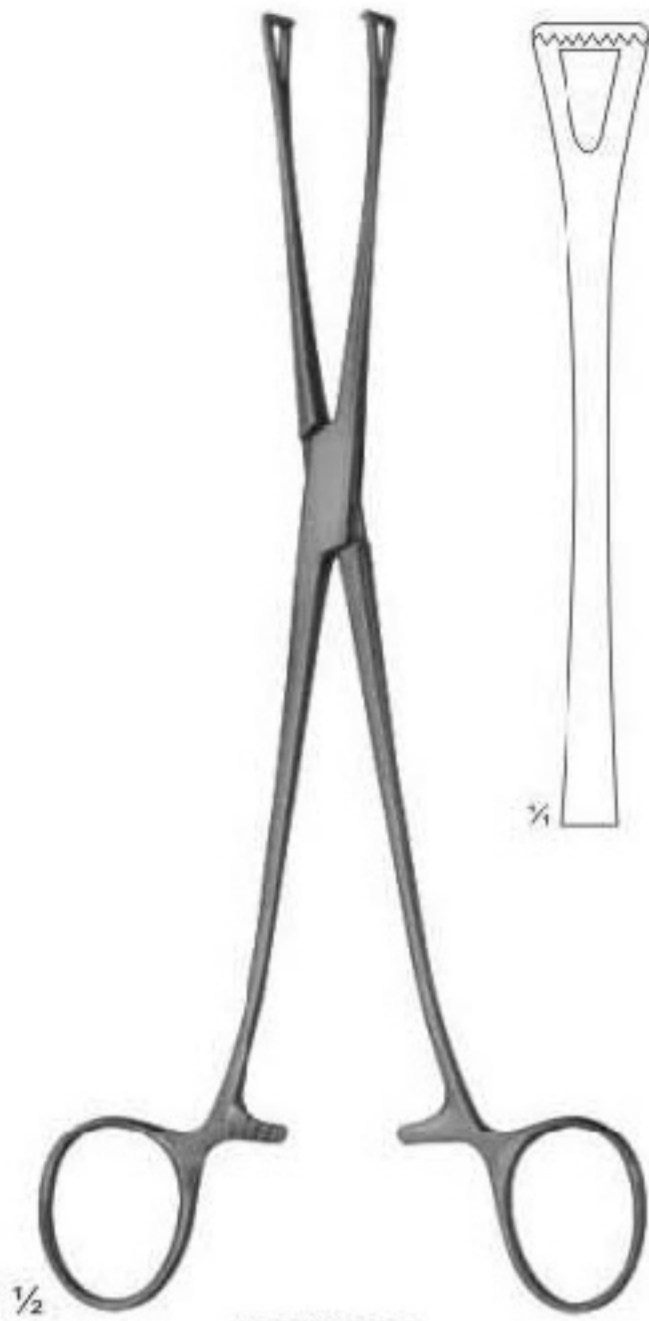

LOCKWOOD
09-1011
20 cm



WILLIAMS
09-1012
16 cm



LANE
09-1013 - 09-1014
09-1013 13 cm
09-1014 15.5 cm

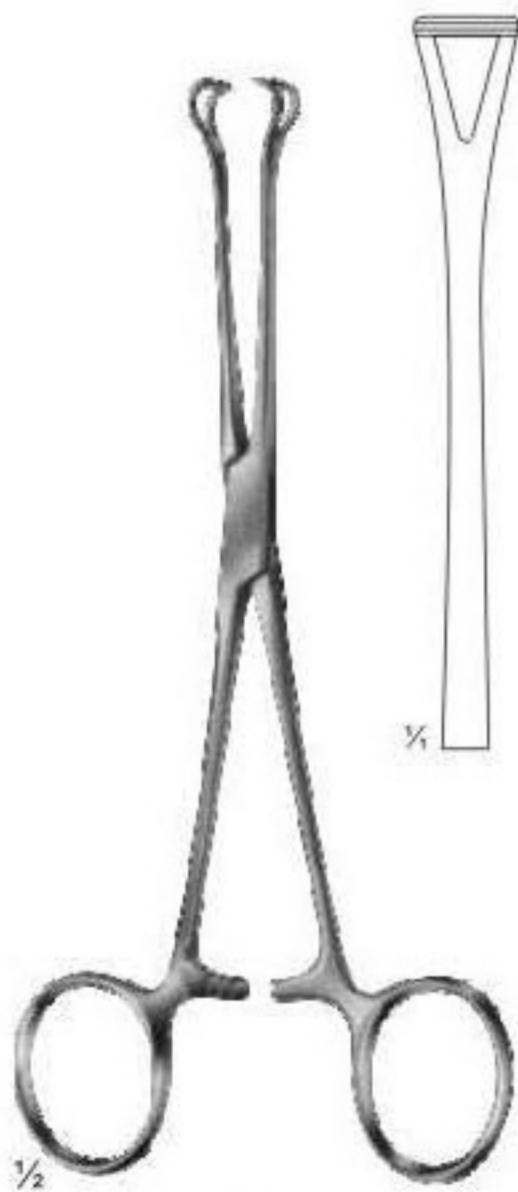

BABCOCK
09-1015 - 09-1018
09-1015 15.5 cm
09-1016 17.5 cm
09-1017 21 cm
09-1018 24 cm

ATRAUMA



BABCOCK
09-1019 - 09-1020
09-1019 16 cm
09-1020 20 cm

TC GOLD



BABCOCK
09-1021 - 09-1022
09-1021 16 cm
09-1022 20 cm

Intestinal And Tissue Grasping Forceps

ATRAUMA

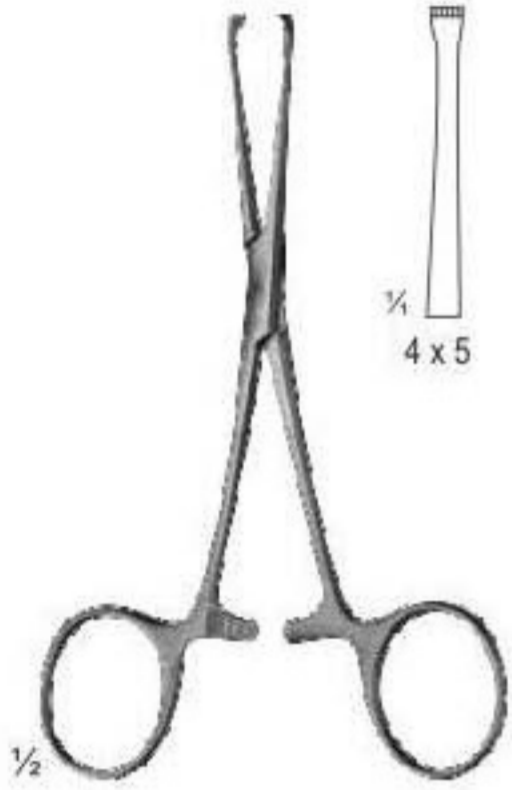

ALLIS (4 x 5 teeth)
09-1023 - 09-1024
09-1023 13 cm (BABY)
09-1024 15.5 cm

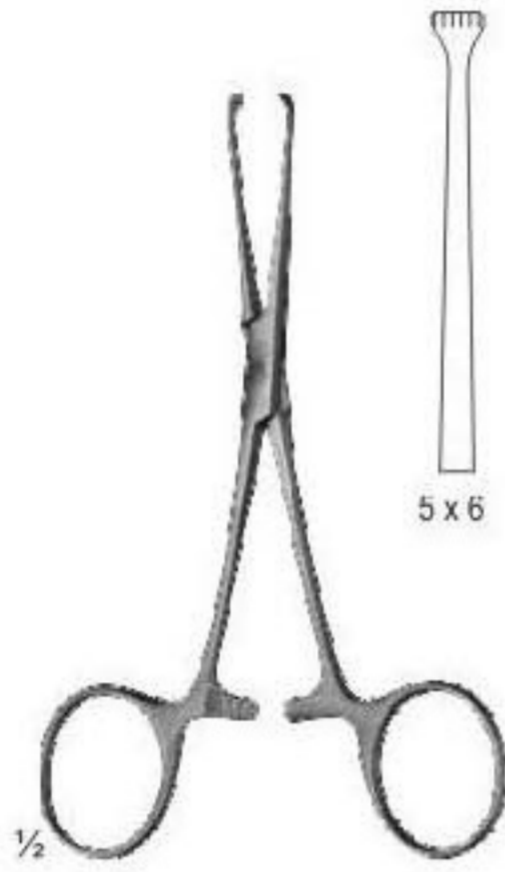

ALLIS (5 X 6 teeth)
09-1025 - 09-1028
09-1025 15.5 cm
09-1026 19 cm
09-1027 20 cm
09-1028 25.5 cm



ALLIS
09-1029 - 09-1033



09-1029
15.5 cm



09-1030
20 cm



09-1031
22 cm



09-1032
25.5 cm



09-1033
30 cm



BOYS-ALLIS (5 X 6 teeth)
09-1034
15.5 mm
sharp



ALLIS-ADAIR
(11 X 12 leeth)
09-1035
16 cm



THOMS-ADAIR
(6 X 7 teeth)
09-1036
20.5 cm

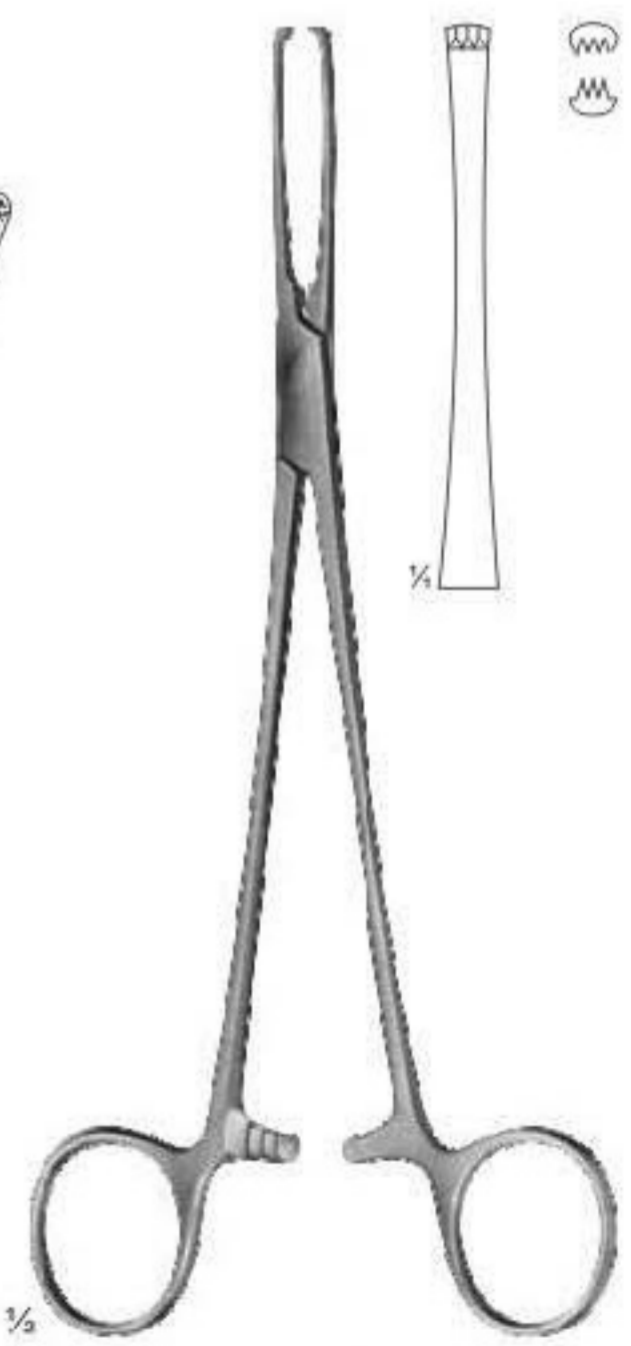

JUDD-ALLIS
(3 X 4 teeth)
09-1037 - 09-1038
09-1037 15.5 cm
09-1038 10 cm

Intestinal Clamps For Children



BAINBRIDGE
09-1039
15.5 cm

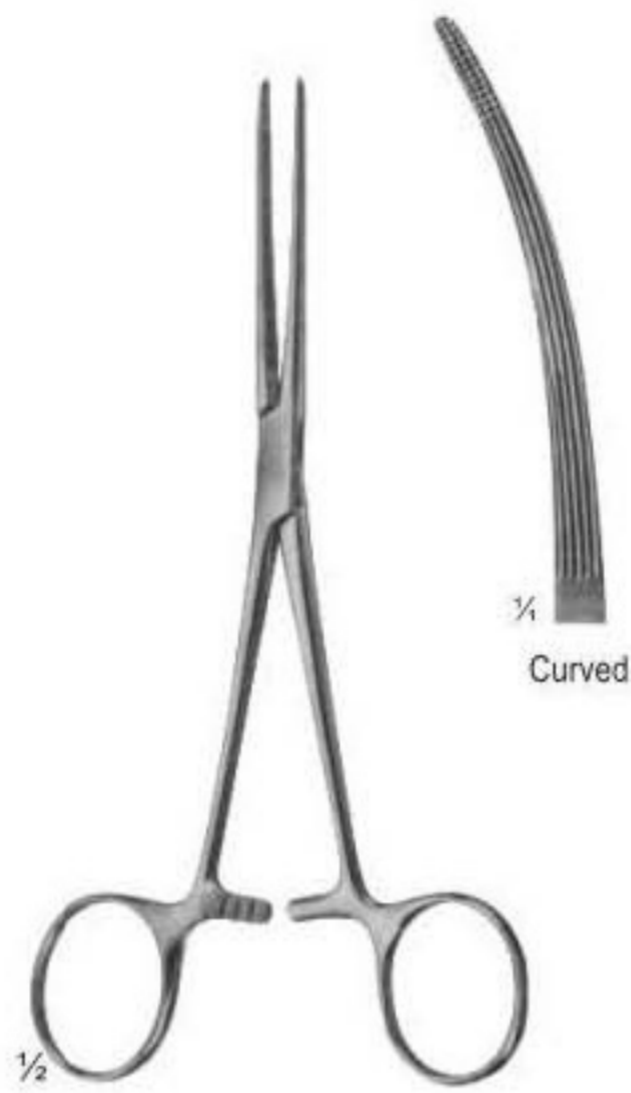

BAINBRIDGE
09-1040
15.5 cm

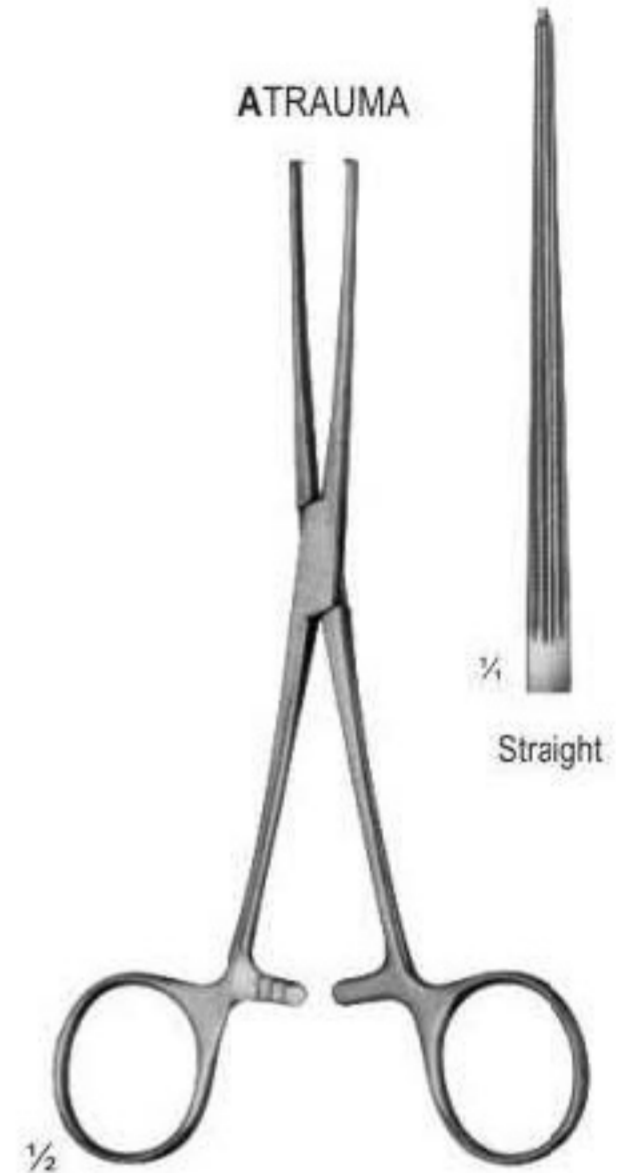

ALLEN
09-1041
15.5 cm

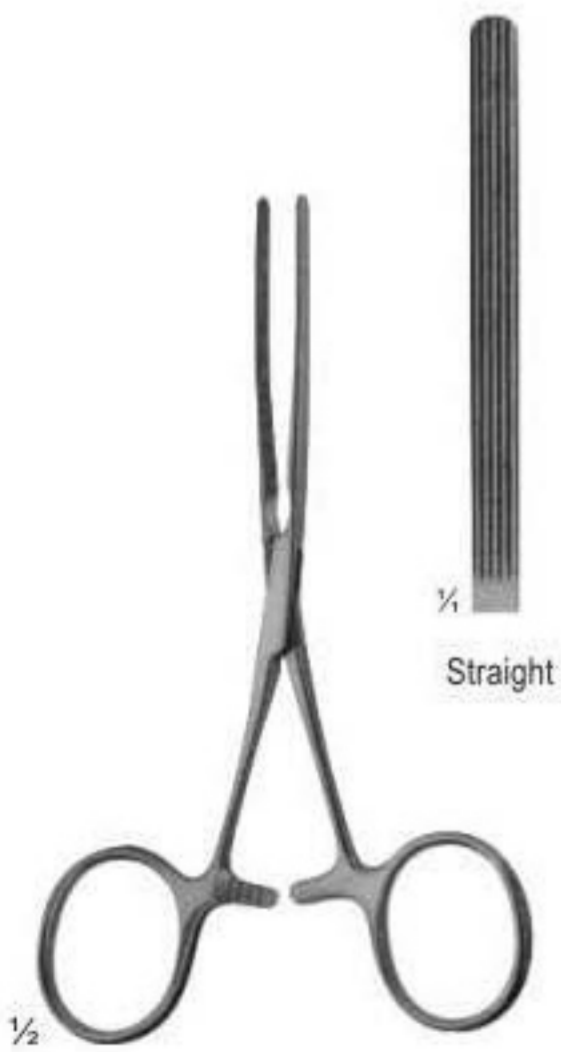

BABY-KOCHER
09-1042
very elastic blades
13 cm



BABY-KOCHER
09-1043
very elastic blades
13 cm

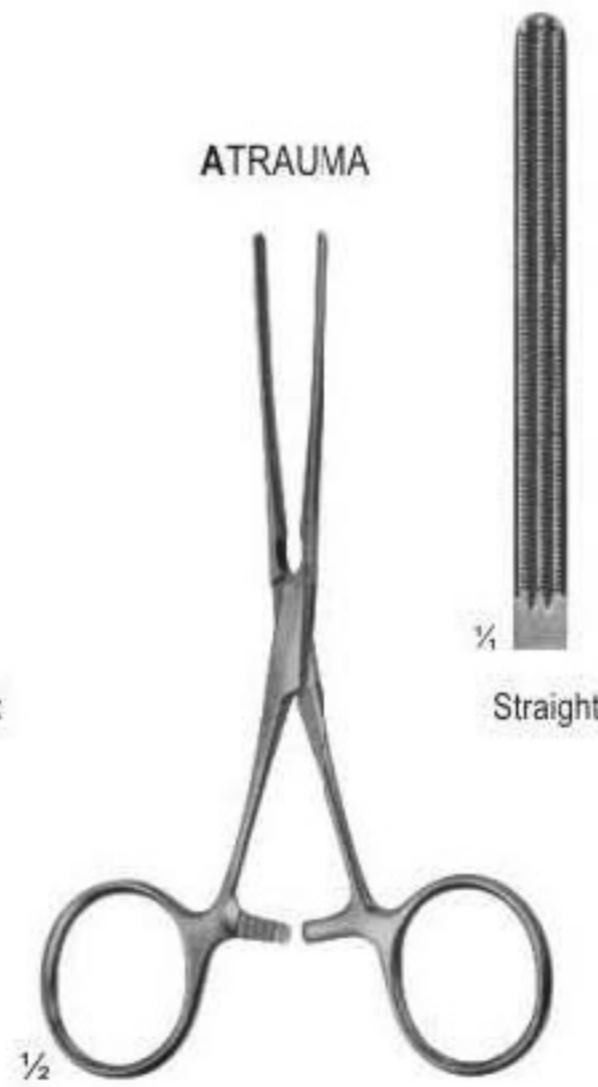

BABY-KOCHER
09-1044
with elastic blades
13 cm

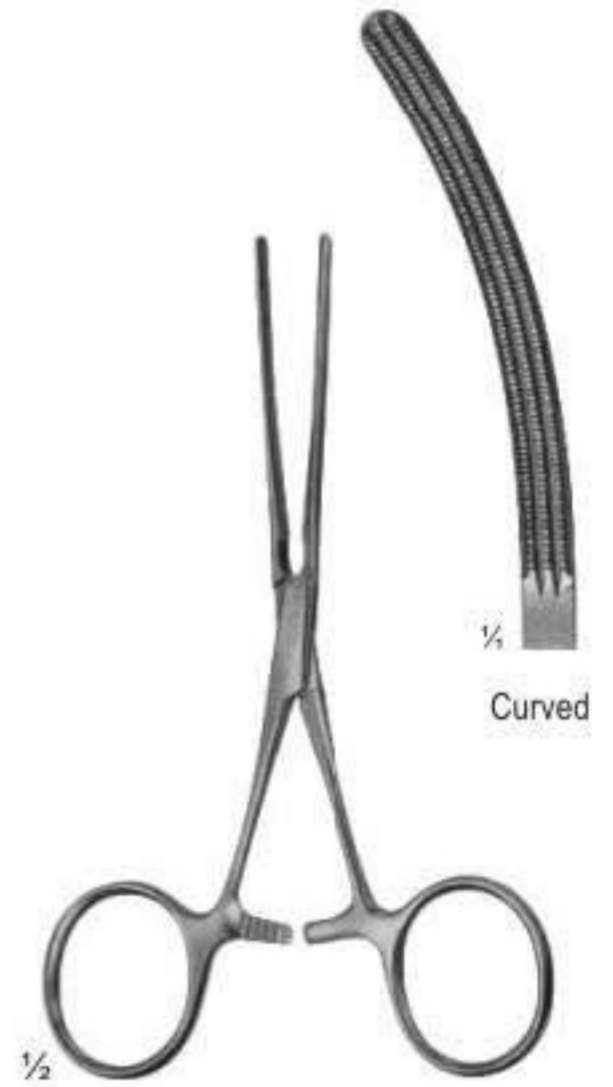

BABY-KOCHER
09-1045
with elastic blades
13 cm

Intestinal Clamps, Soft Elastic



Straight

KOCHER
09-1046 - 09-1047
with elastic blades
09-1046 21 cm
09-1047 23 cm



Curved

KOCHER
09-1048 - 09-1049
with elastic blades
09-1048 21 cm
09-1049 23 cm



Straight

DOYEN
09-1050
with elastic blades
21 cm



Curved

DOYEN
09-1051
with elastic blades
21 cm

Intestinal Clamps, Soft Elastic



Straight

**DOYEN
09-1052**
with elastic blades
23.5 cm



Curved

**DOYEN
09-1053**
with elastic blades
23.5 cm

ATRAUMA



Straight

**DOYEN
09-1054**
with elastic blades
23 cm



Curved

**DOYEN
09-1055**
with elastic blades
23 cm

Intestinal Clamps, Soft Elastic

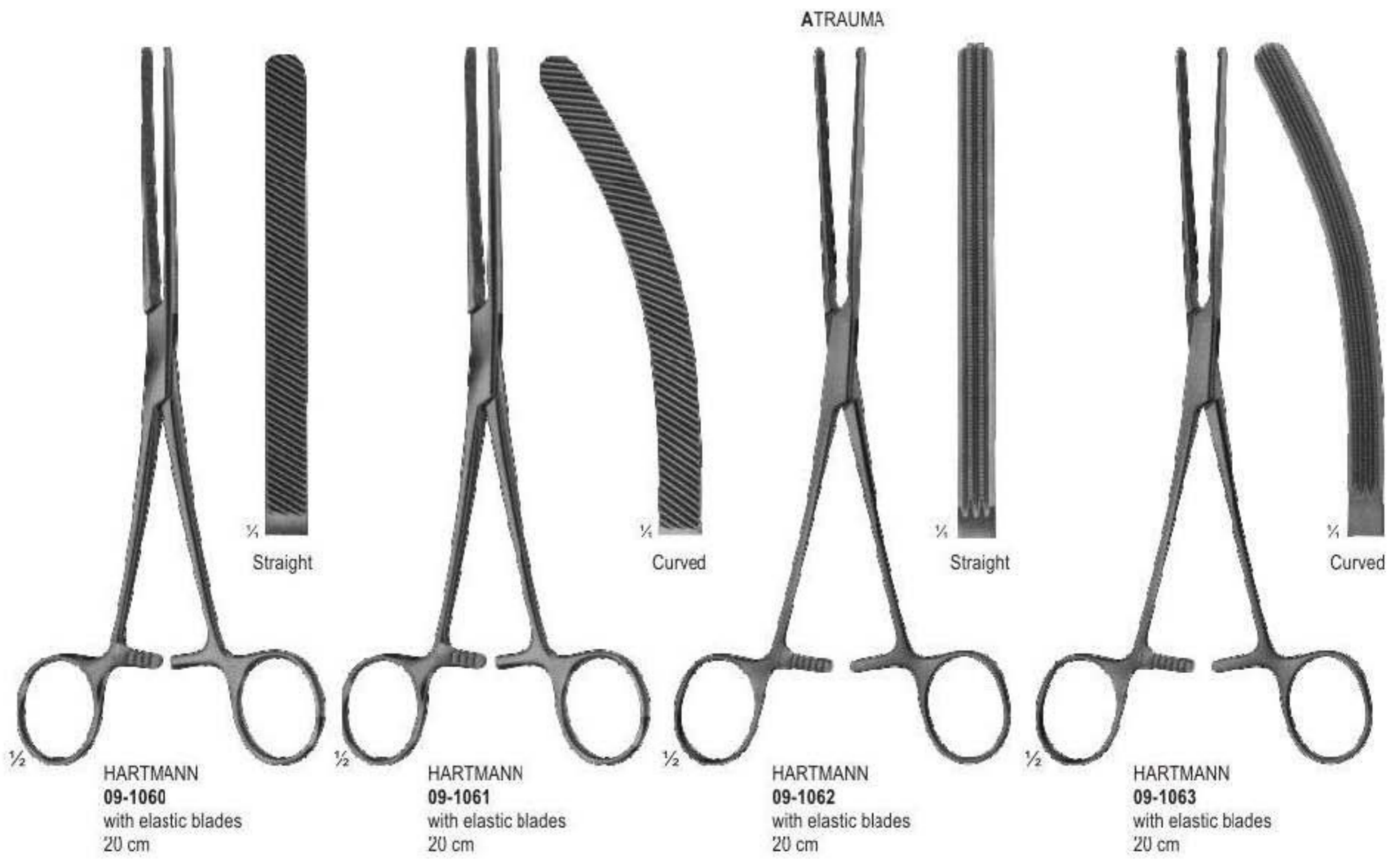
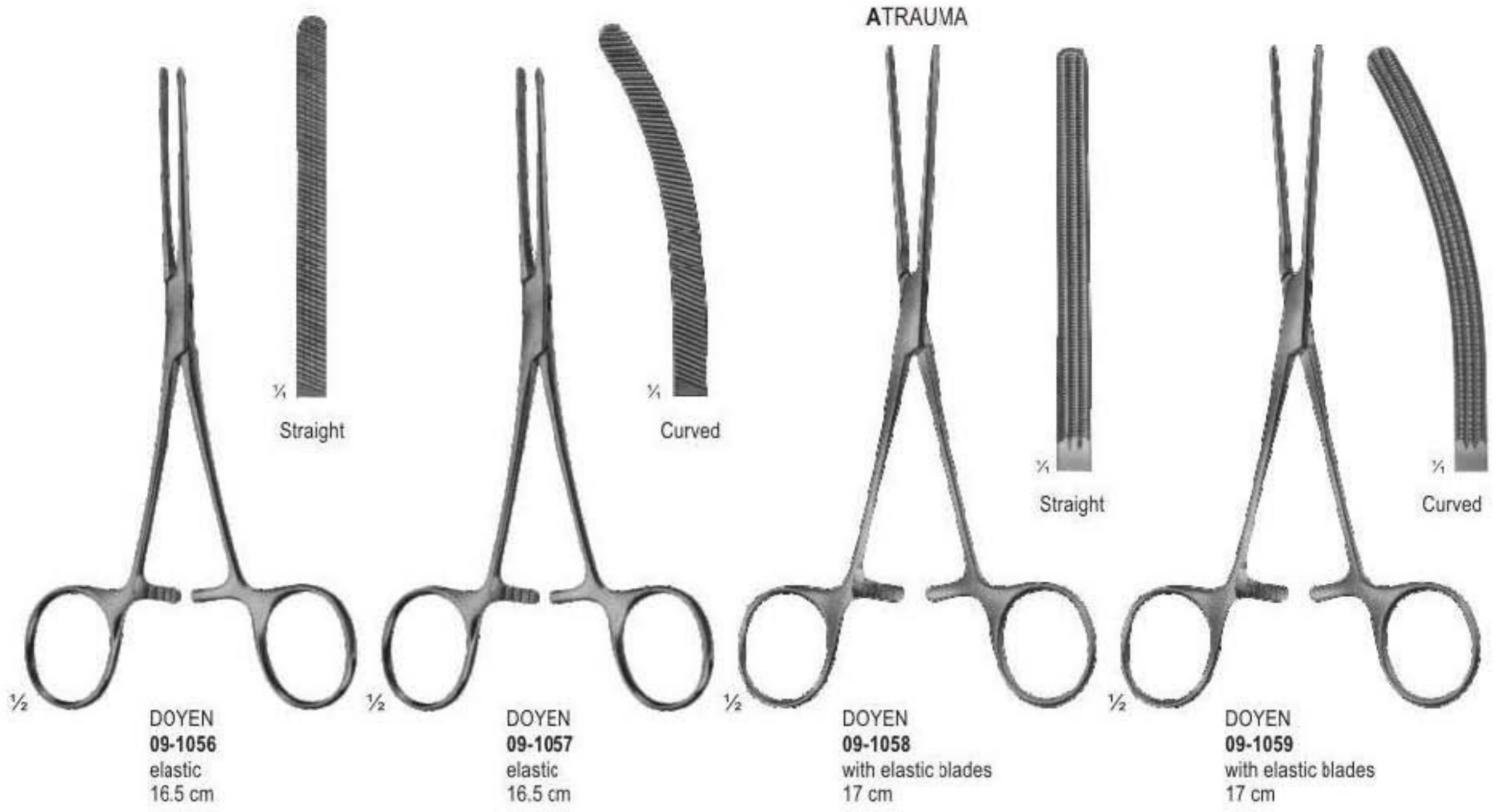

Intestinal Clamps, Soft Elastic



BRUNNER
09-1064
23 cm

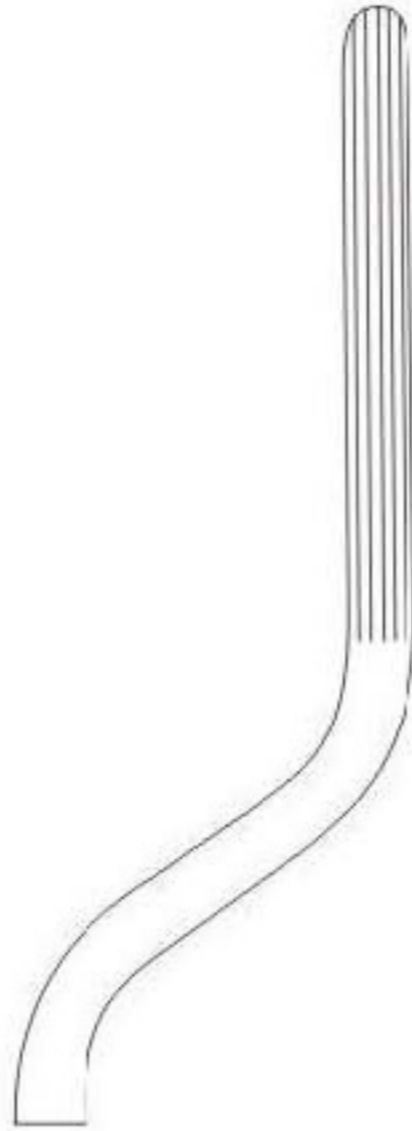

FEHLÄND
09-1065
24 cm



Straight

KOCHER
with very elastic blades
09-1066 - 09-1068
09-1066 22 cm
09-1067 25 cm
09-1068 28 cm



Curved

KOCHER
with very elastic blades
09-1069 - 09-1071
09-1069 22 cm
09-1070 25 cm
09-1071 28 cm

Intestinal Clamps



$\frac{1}{2}$
MAYO-ROBSON
09-1072
25 cm

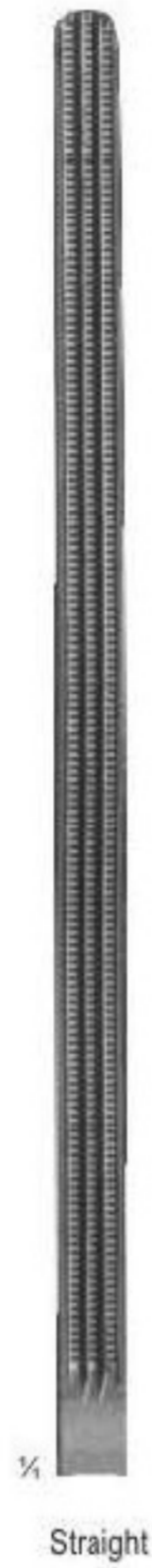

Straight



$\frac{1}{2}$
MAYO-ROBSON
09-1073
25 cm



Curved

Intestinal Clamps



MAYO-ROBSON
09-1074
hard elastic
25 cm



MAYO-ROBSON
09-1075
hard elastic
25 cm



Intestinal Clamps



NUSSBAUM
09-1076
with elastic blades
25 cm



NUSSBAUM
09-1077
with elastic blades
25 cm

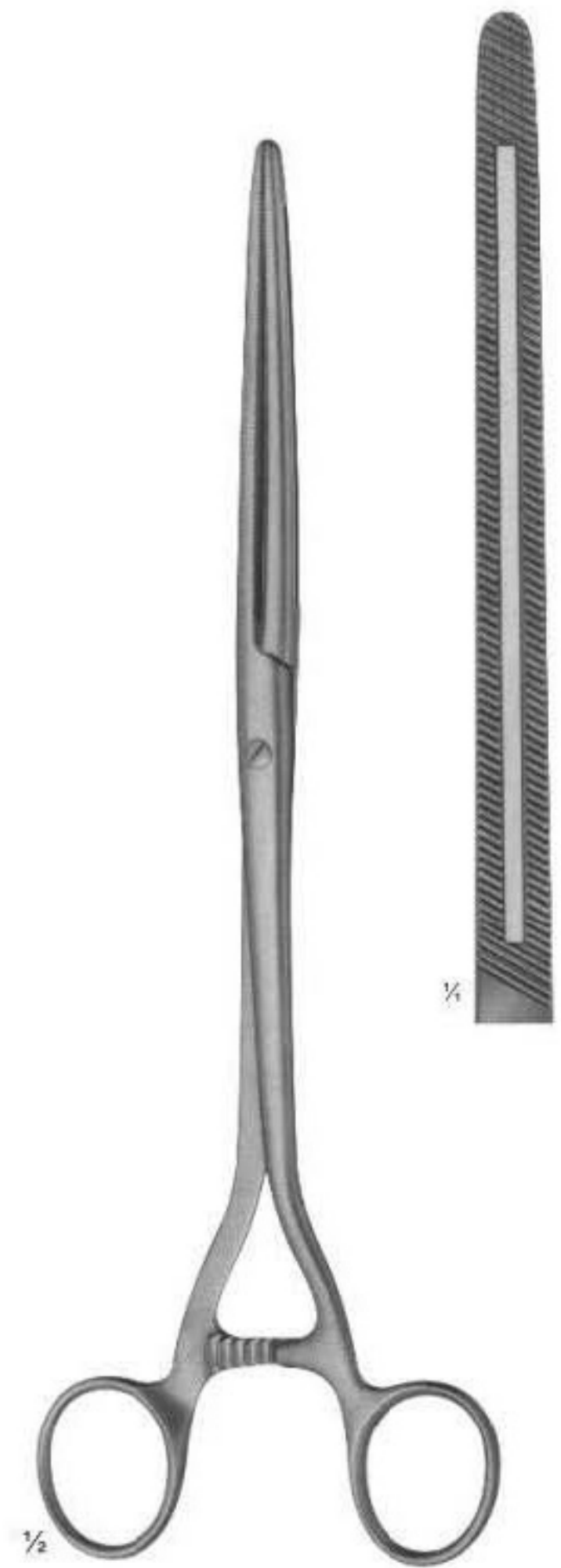

MOYNIHAN
09-1078
28 cm



Intestinal Clamps

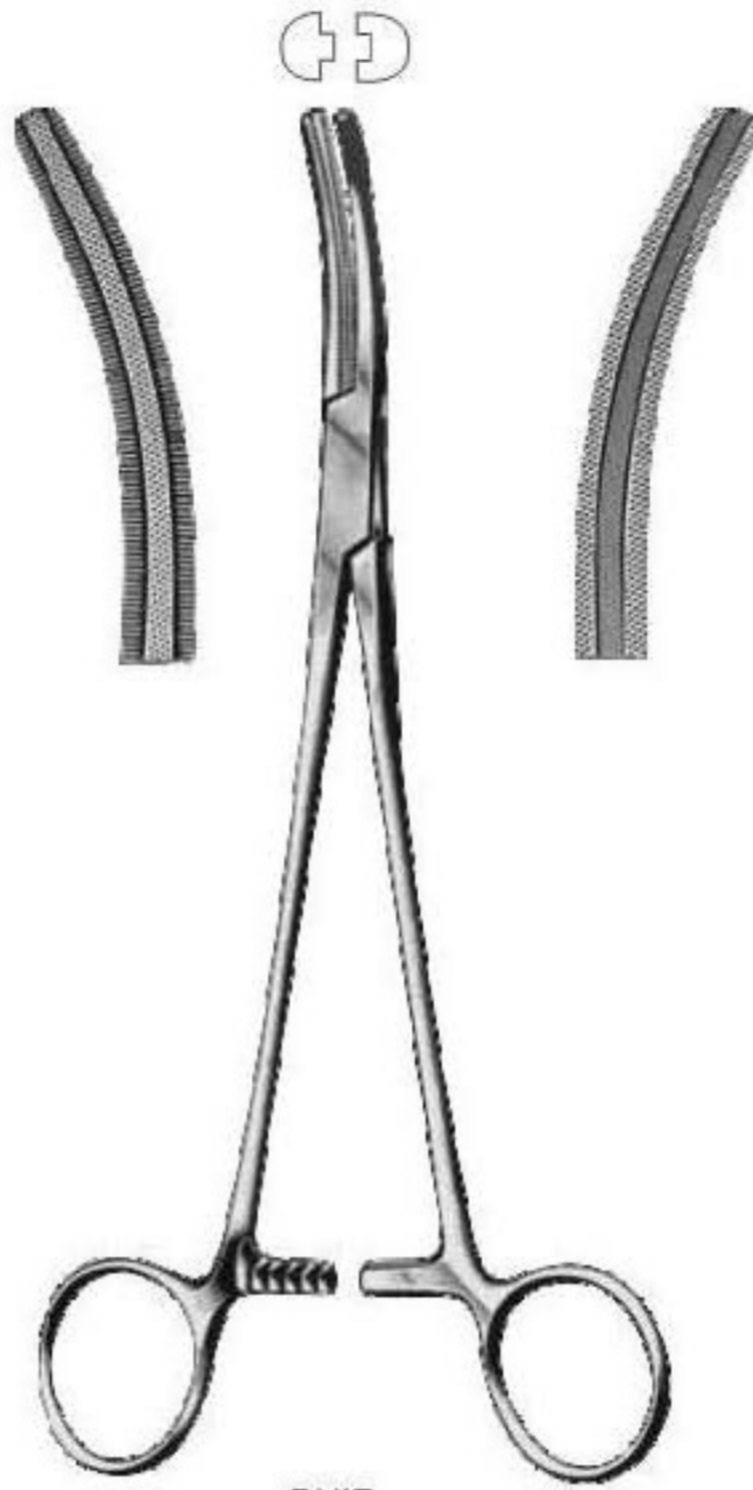

BUIE
09-1079
21 cm



FERGUSSON
09-1080

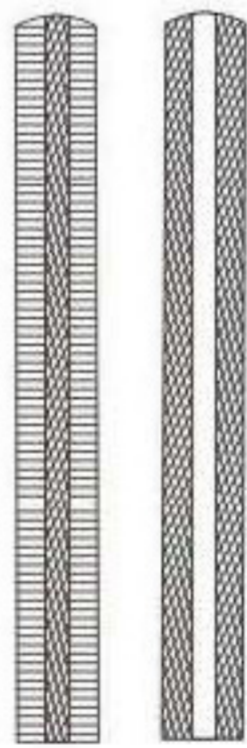

09-1080
20 cm



FERGUSSON
09-1081

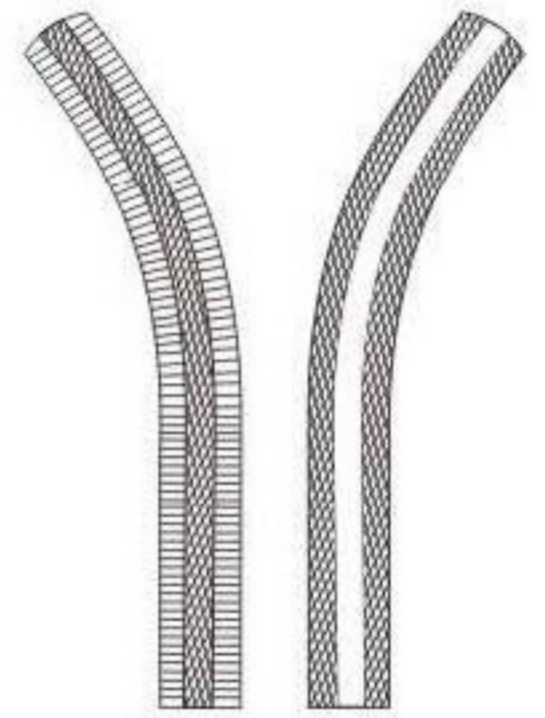

09-1081
20 cm

Intestinal Clamps

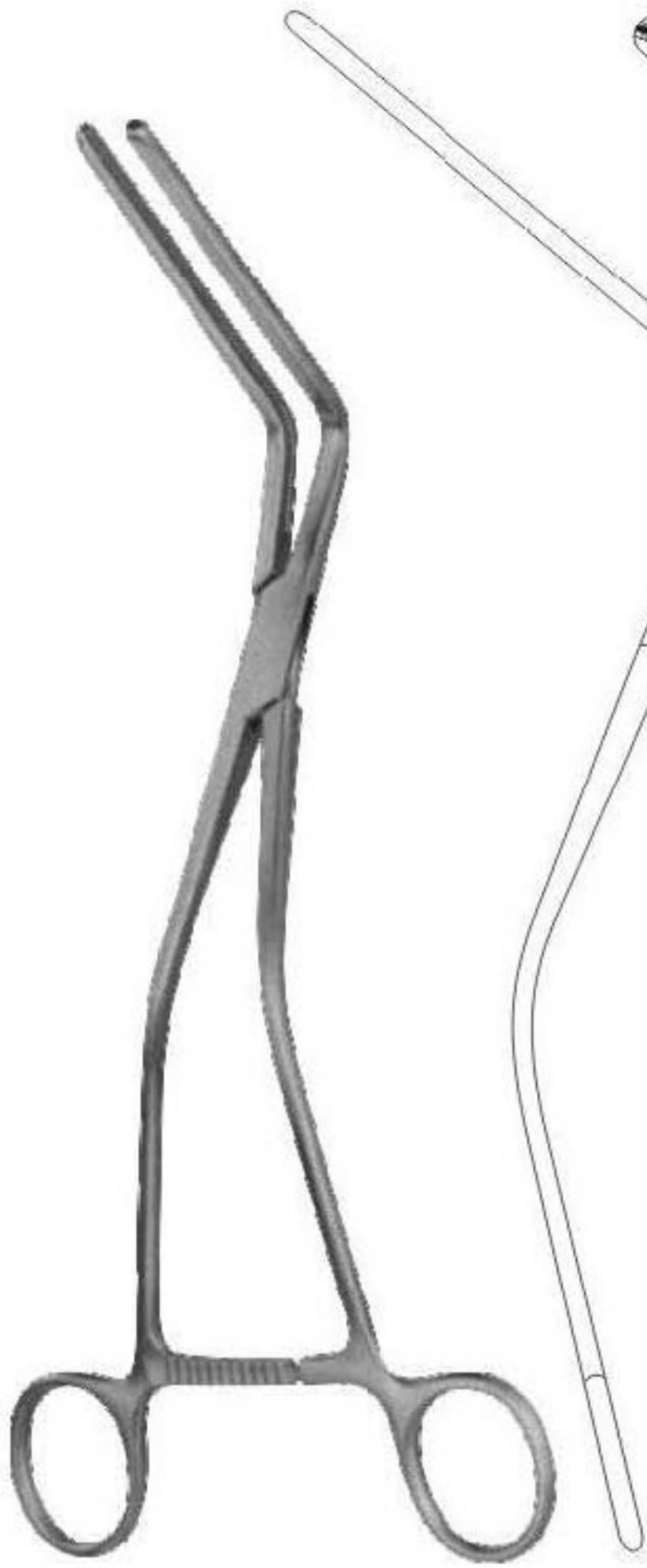

HAYES-DEBAKEY
09-1082 - 09-1083



09-1082
26 cm
55 mm

09-1083
28 cm
85 mm



FEHLAND-DEBAKEY
09-1084
24 cm

Intestinal Clamps

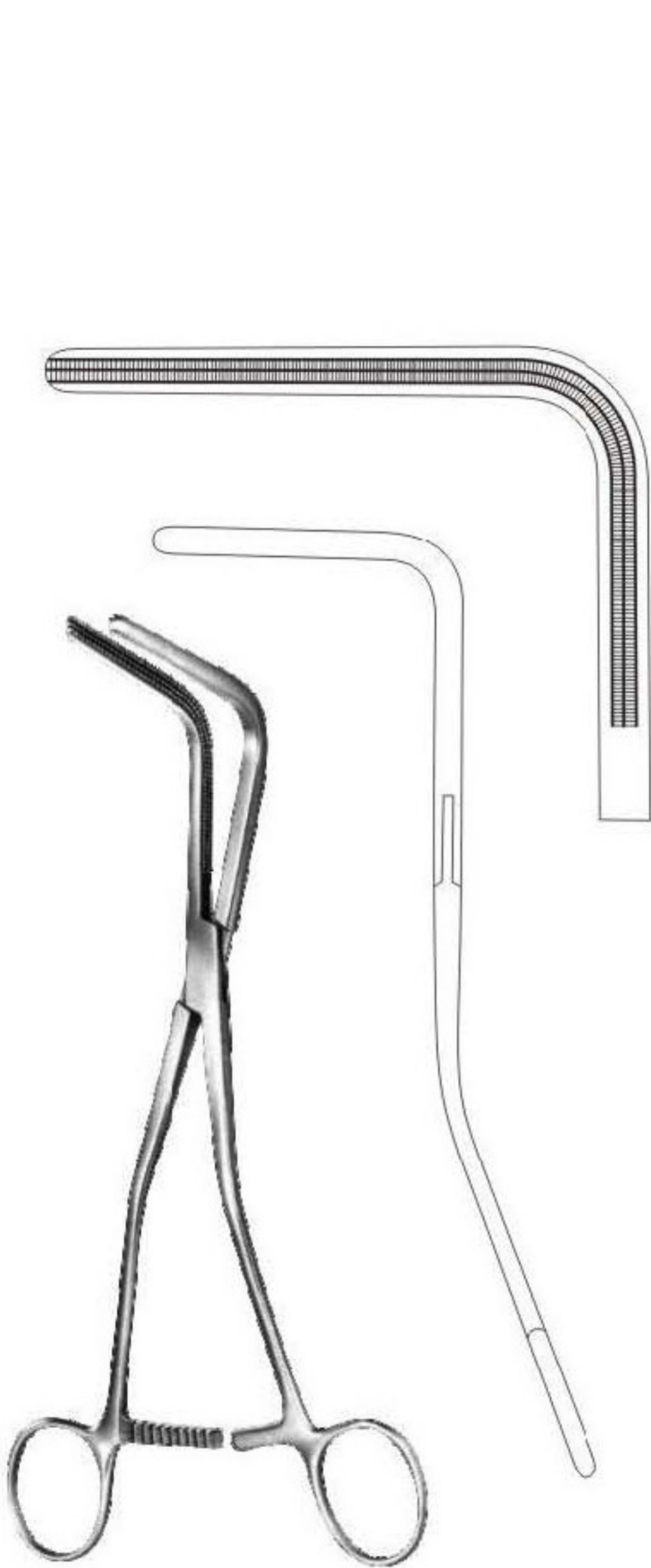

VEIDENHEIMER
09-1085
25 cm

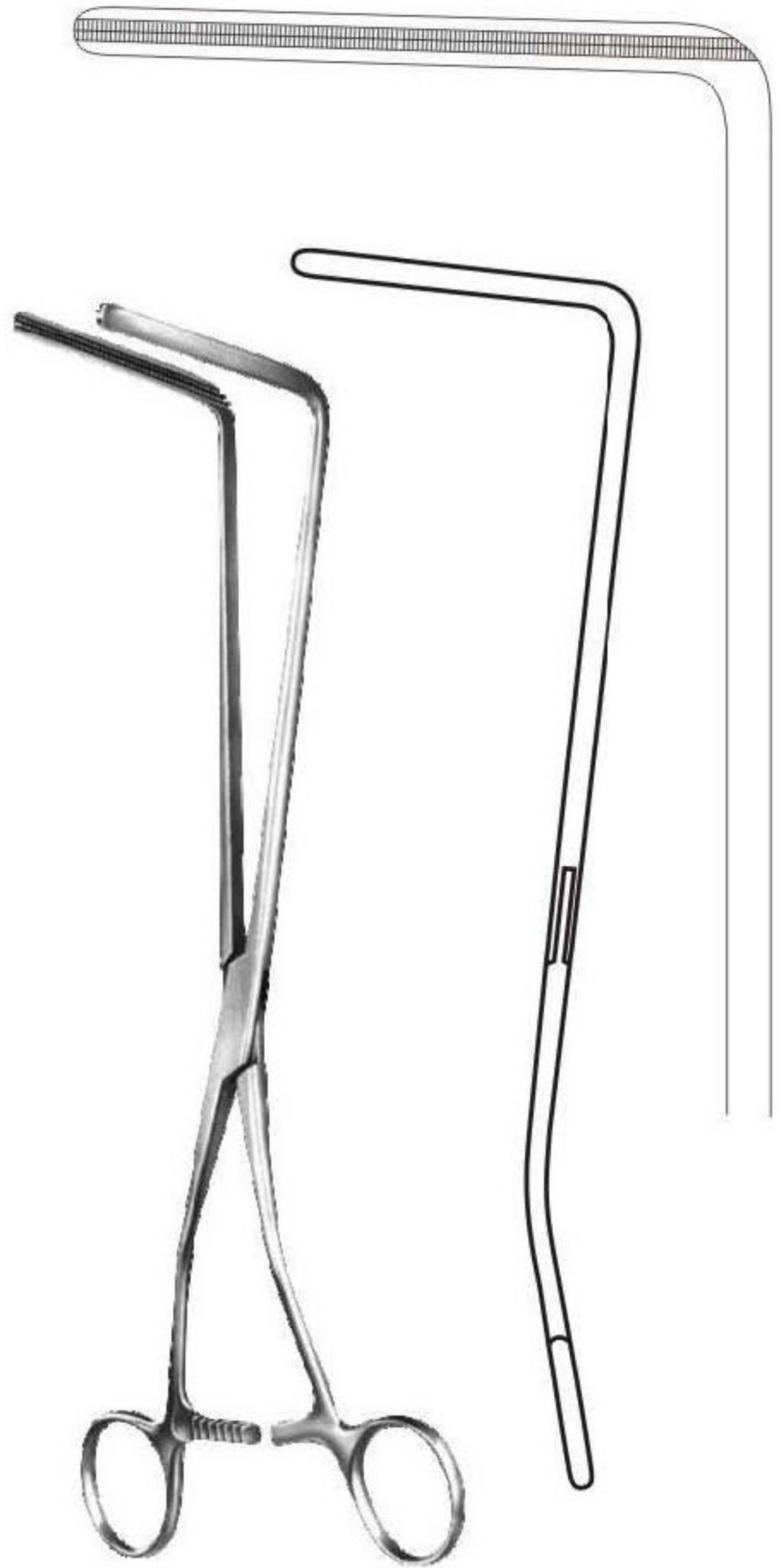

RESANO
09-1086
28 cm

Stomach Clamps

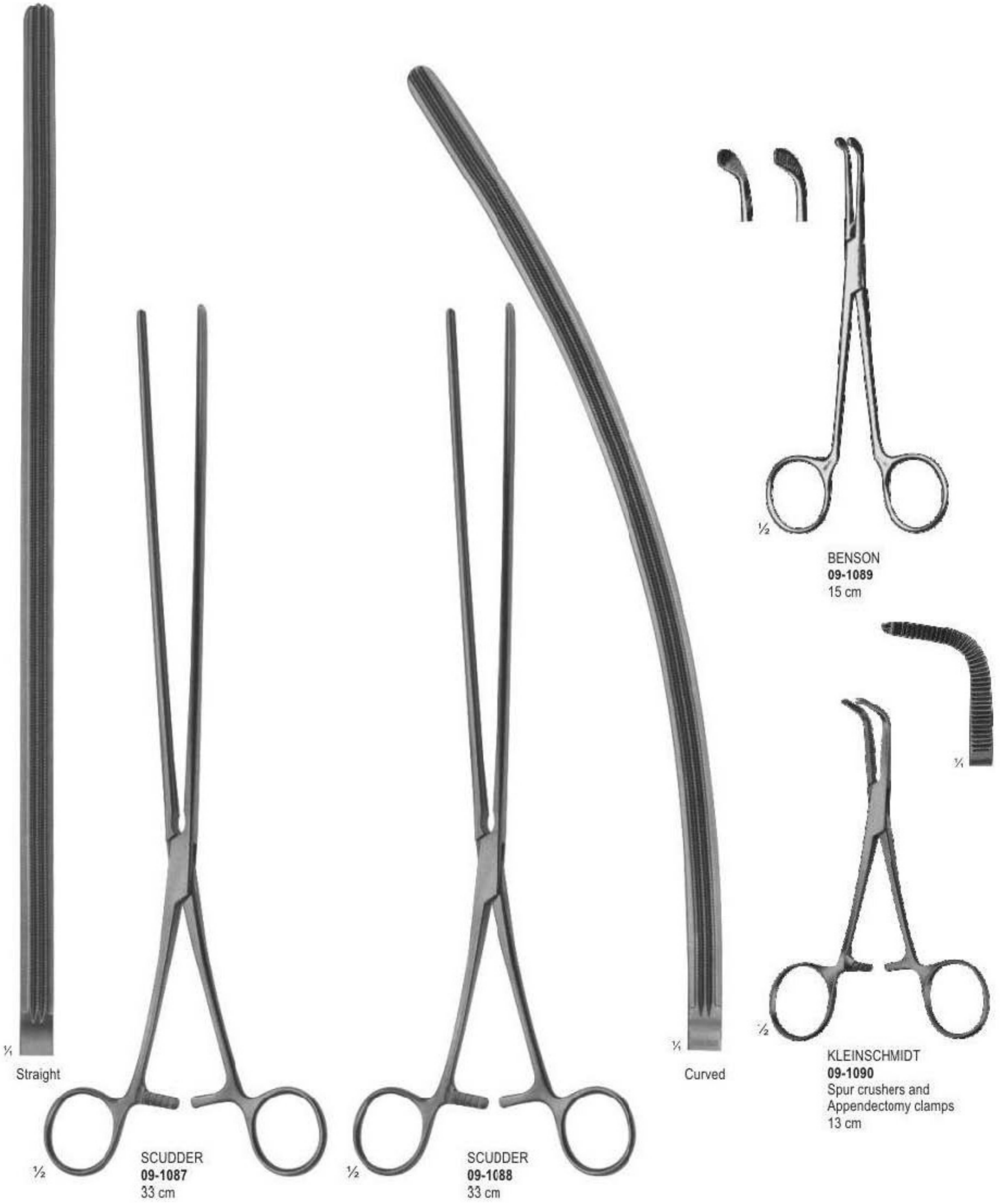

Intestinal And Pylorus Clamps



PAYR 09-1091
Intestinal clamp light pattern, for children
18 cm

PAYR 09-1092
20 cm

PAYR 09-1093
27.5 cm

PAYR 09-1094
Pylorus clamp
31.5 cm

Intestinal Anastomosis Clamps



DEMARTEL-
WOLFSON
09-1095 - 09-1097



09-1095
5 cm
Set of 3 clamps



09-1096
7.5 cm
Set of 3 clamps



09-1097
10 cm
Set of 3 clamps



DEMARTEL-
WOLFSON
09-1098
23 cm



DEMARTEL-
WOLFSON
09-1099
26 cm



DEMARTEL
WOLFSON
09-1100
8.5 cm



STONE
09-1101
15.5 cm



STONE-WATT
09-1102 - 09-1103
09-1102 7.5 cm
09-1103 10 cm

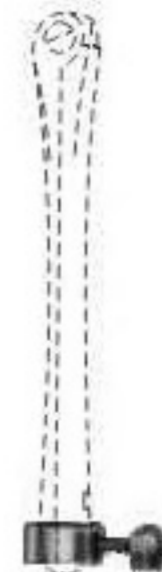

STONE-WATT
09-1104

Rectal Speculums



SCHULZE-BERGMANN
09-1105 - 09-1107
22 cm

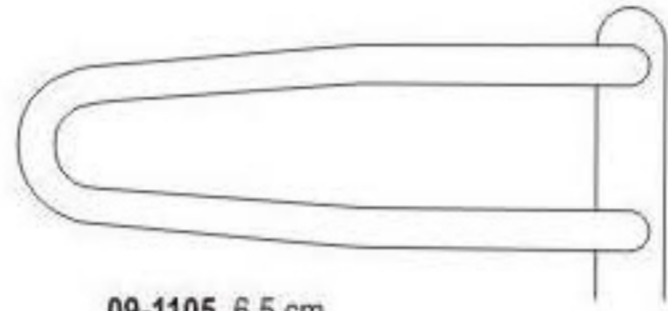

09-1105 6.5 cm

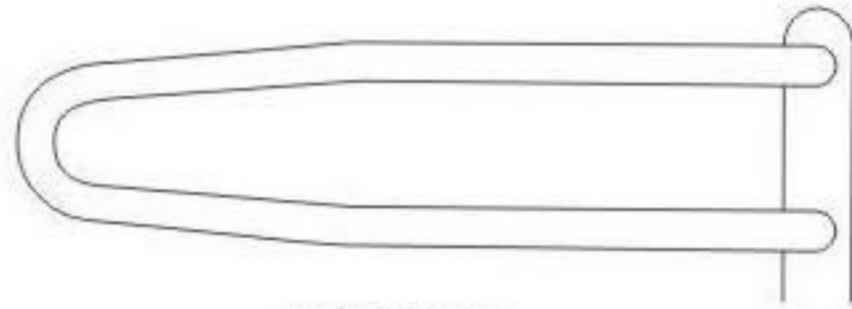

09-1106 8.5 cm

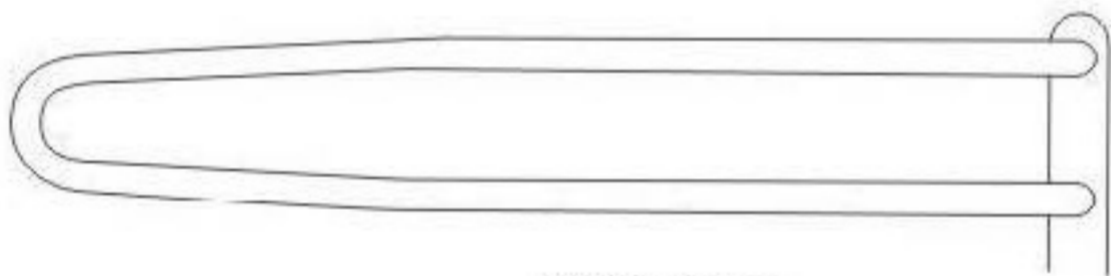

09-1107 12.5 cm

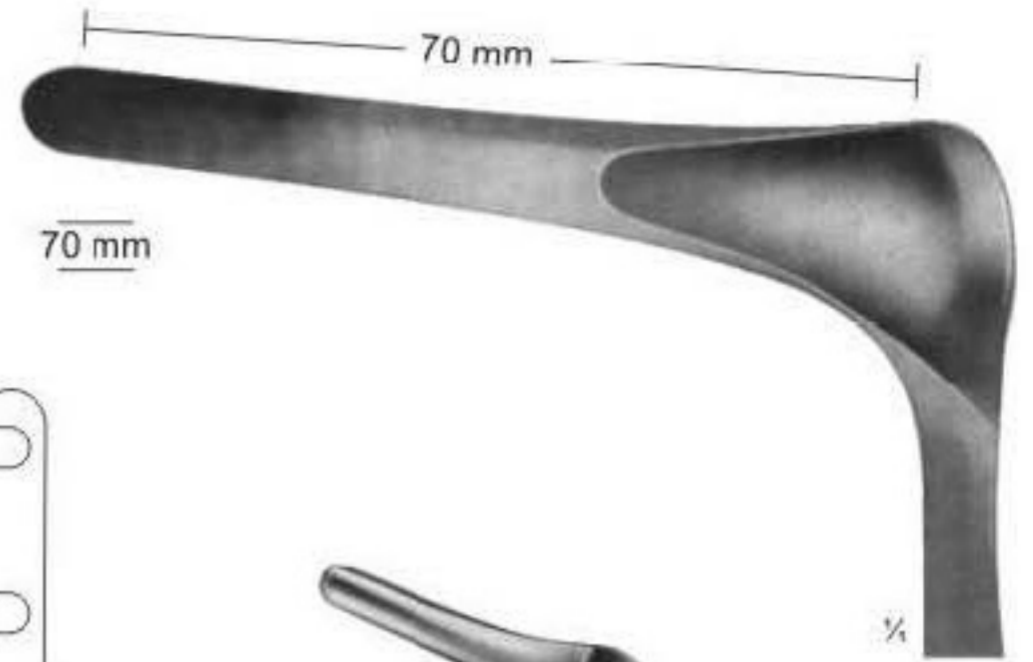

KILLIAN
09-1108
for children
14.5 cm



BODENYHAMMER
09-1109
15.5 cm



SIMS
09-1110
16 cm

Rectal Specula

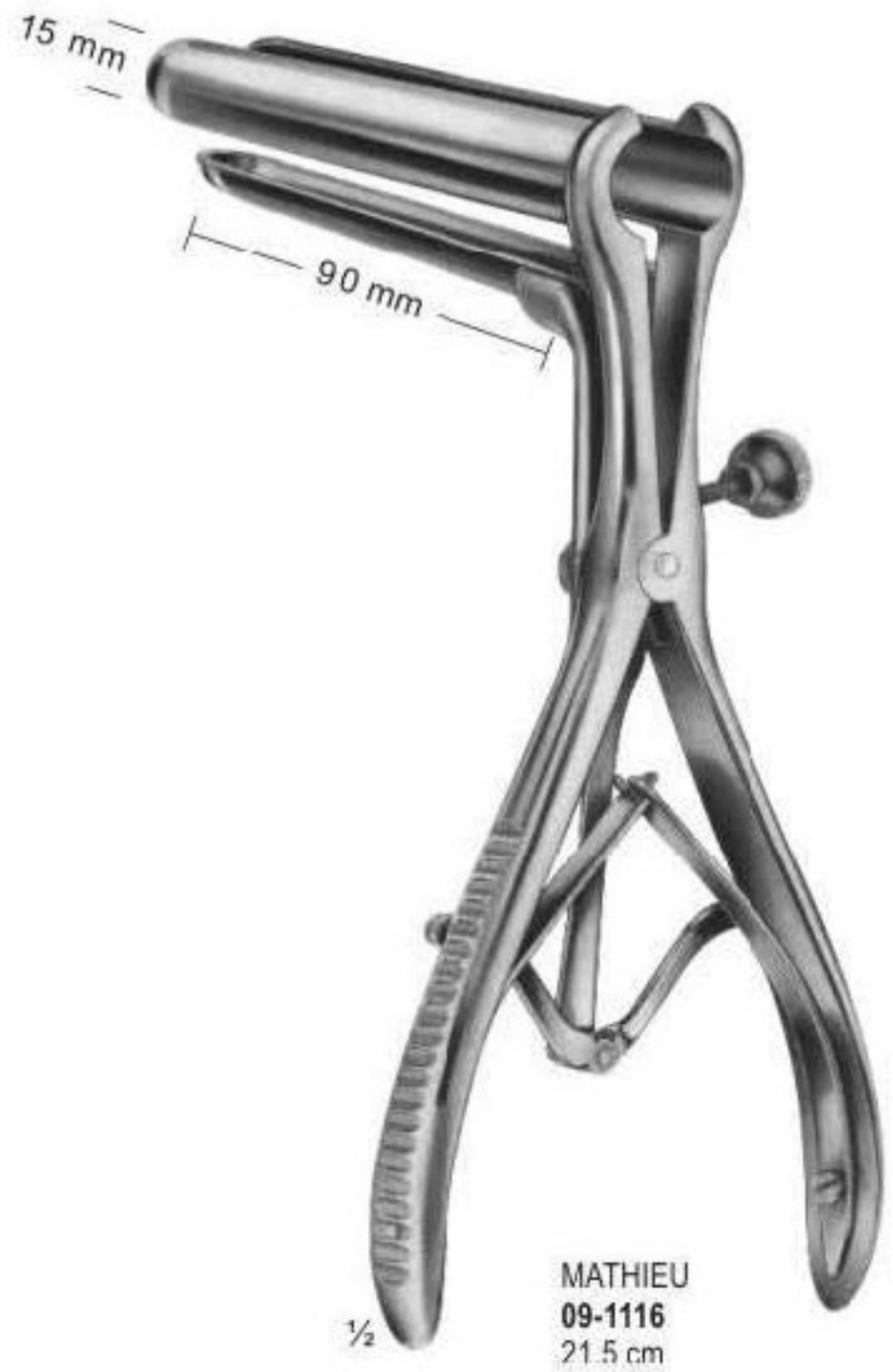
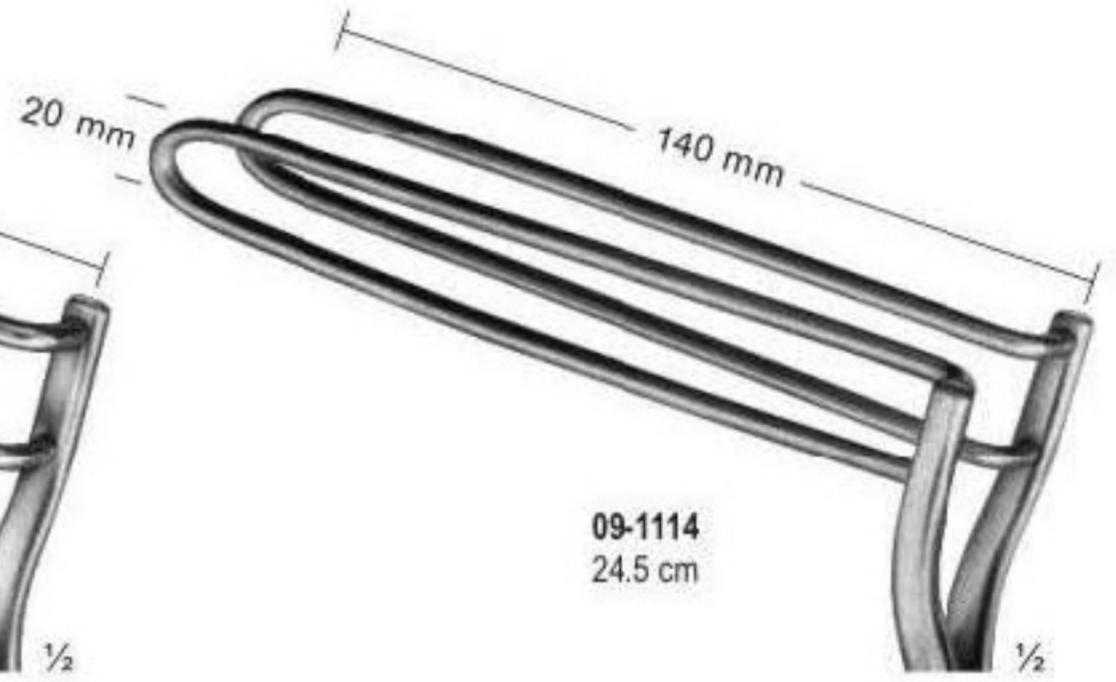
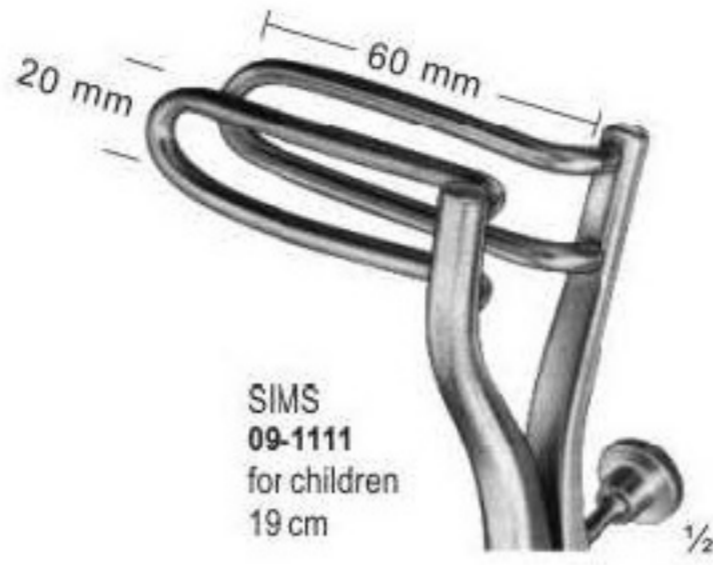

Intestinal And Pylorus Clamps



CZERNY
09-1117
22 cm



ROSCHKE
09-1118
with fibre optic



SMITH-BUIE
09-1119
15 cm



70 x 22 mm

BARR
09-1120
17 cm



BRINKERHOFF
09-1121 - 09-1123
09-1121 13 - 25 mm Ø / 89 mm
09-1122 13 - 25 mm Ø / 102 mm
09-1123 19 - 32 mm Ø / 114 mm

Rectal Spreaders

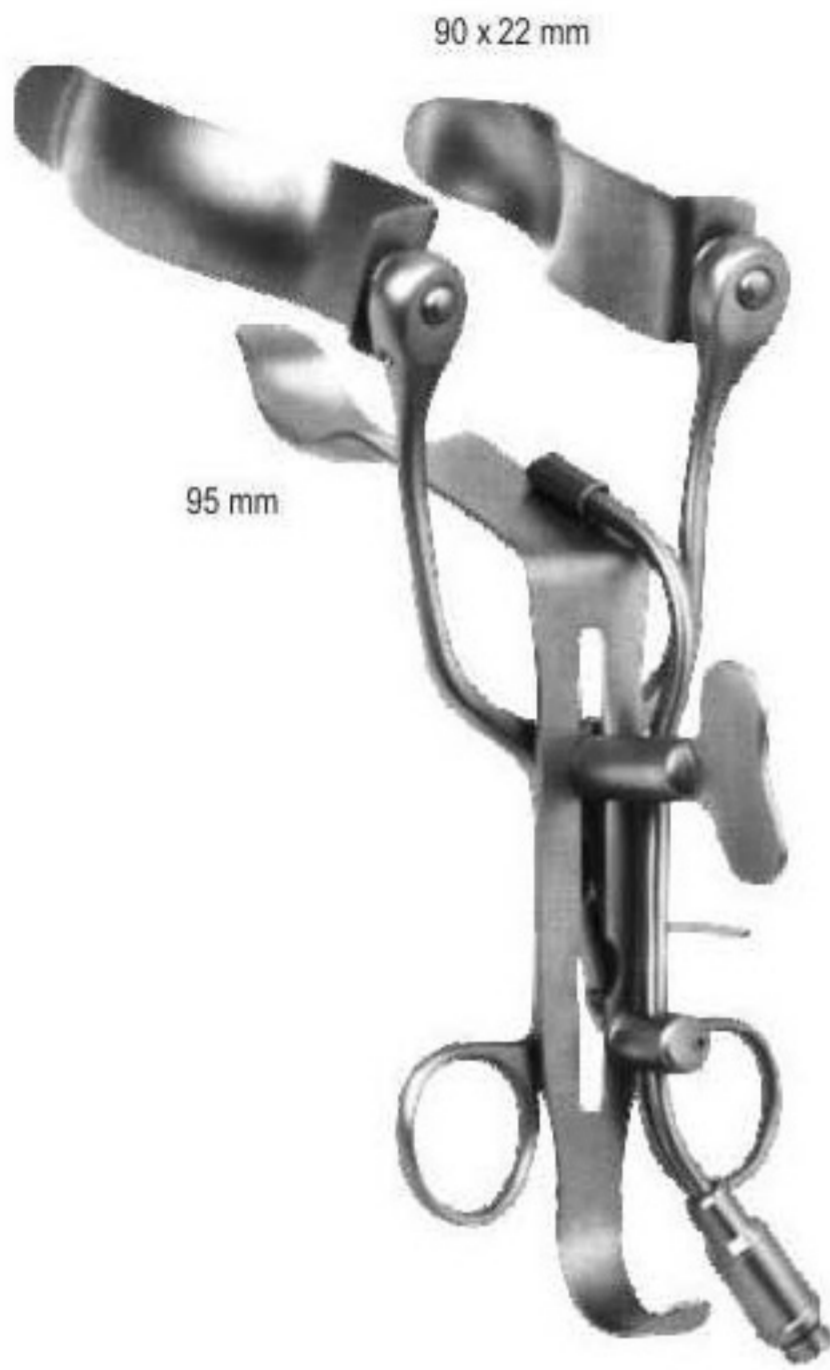

ALAN-PARKS
09-1124
15 cm

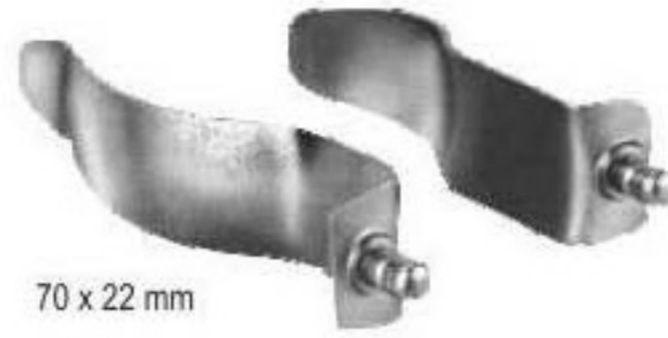

70 x 22 mm



FIBER OPTIC
09-1125



ALAN-PARKS
09-1126
15 cm

Anusopes-sphincteroscopes



KELLY
09-1127 - 09-1130
 09-1127 50 x 22 mm
 09-1128 100 x 22 mm
 09-1129 145 x 22 mm
 09-1130 200 x 22 mm



KELLY
09-1131 - 09-1132
 09-1131 50 x 21 mm
 09-1132 50 x 27 mm



BENSAUDE
09-1133 - 09-1134
 09-1133 70 x 19 mm
 09-1134 70 x 22 mm



HIRSCHMANN
09-1135 - 09-1137
 09-1135 65 x 16 mm
 09-1136 65 x 19 mm
 09-1137 65 x 22 mm



IVES-FANSLER
09-1138
 Anuscope
 14.5 cm

Hemorrhoidal Ligator



MCGIVNEY
09-1139
19 cm

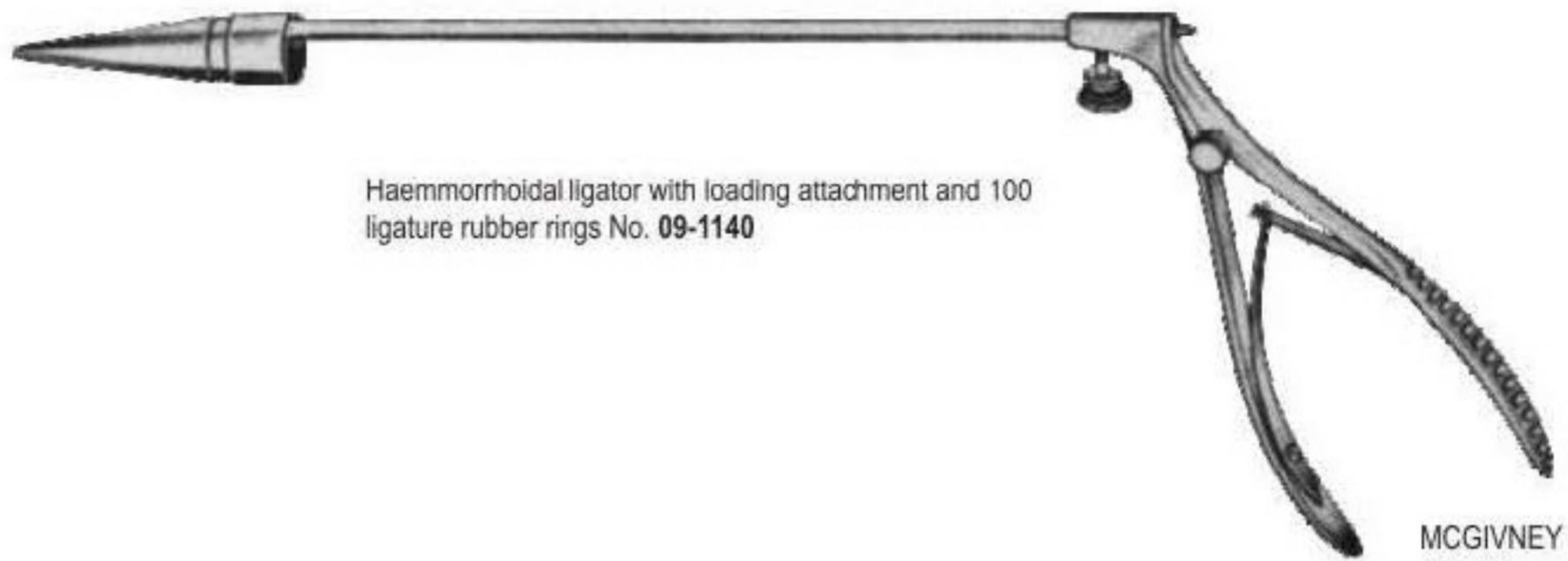

Haemorrhoidal ligator with loading attachment and 100 ligature rubber rings No. 09-1140

MCGIVNEY
09-1140

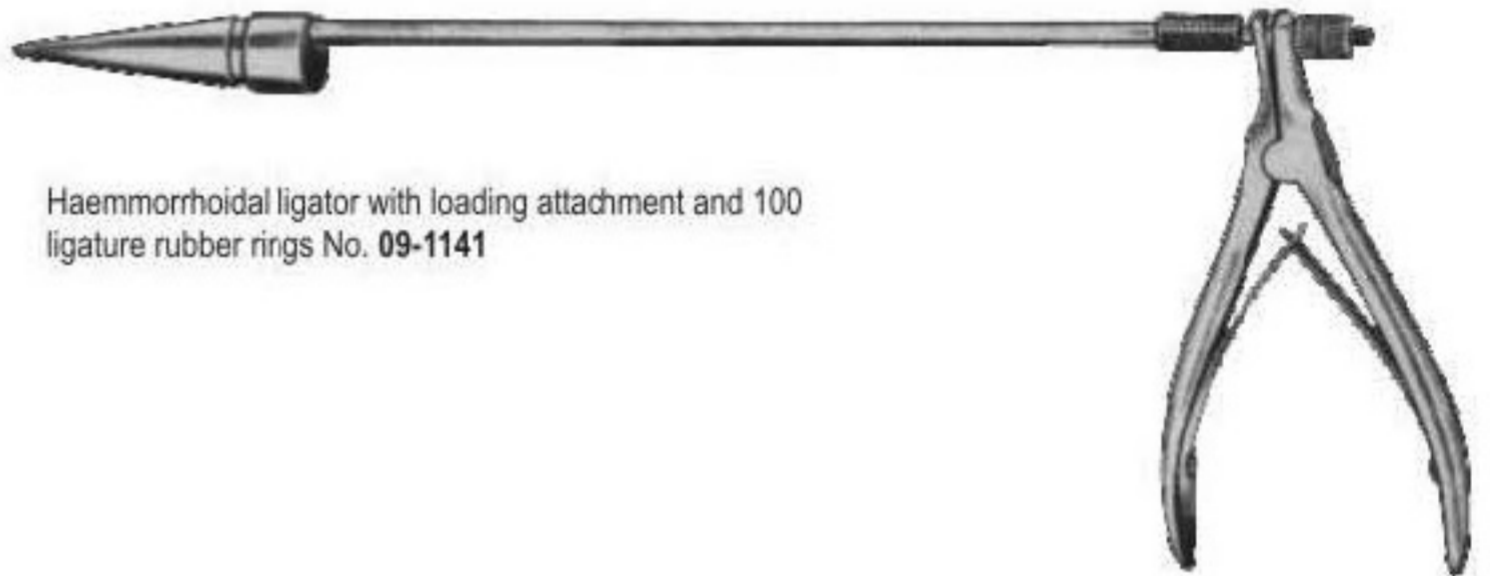

Haemorrhoidal ligator with loading attachment and 100 ligature rubber rings No. 09-1141

FORD-DIXON
09-1141

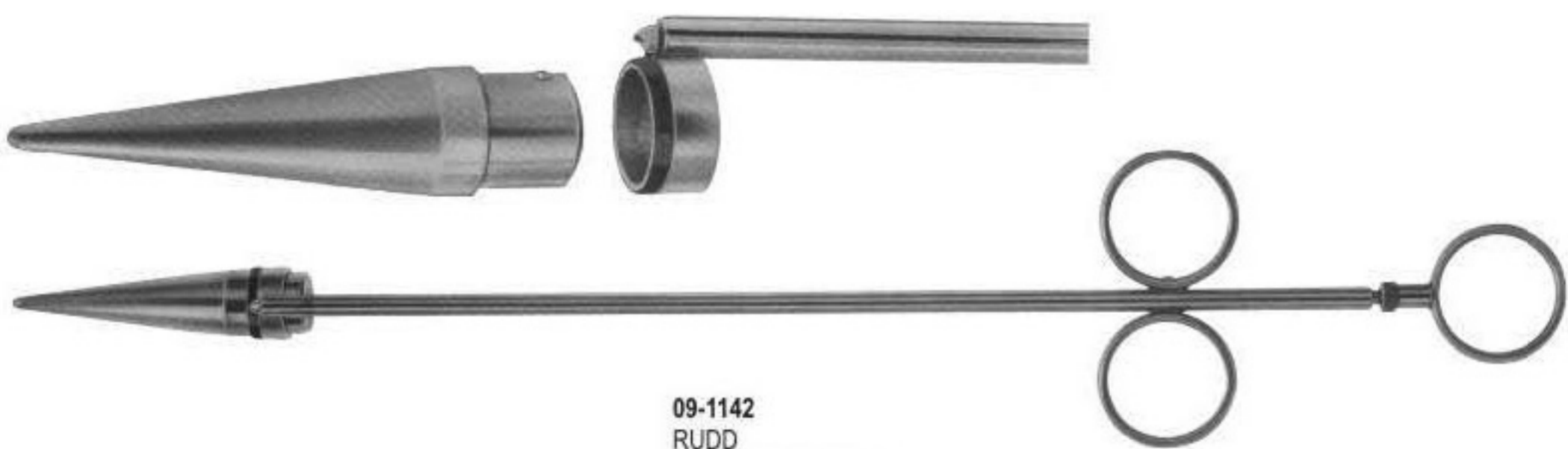

09-1142
RUDD
Haemorrhoidal ligator
with loading
attachment and 100
ligature rubber rings
31.5 cm



RUDD
09-1143
100 pieces

Biopsy Forceps and Swab Holders



BUIE
09-1144
16 cm



PRATT
09-1145 - 09-1147
21.5 cm



Fig. 1
09-1145



Fig. 2
09-1146

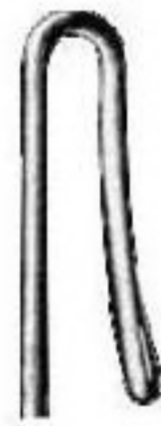

Fig. 3
09-1147



09-1148
12 pieces / 12 piezas



WESTON
09-1149
30 cm



NORWOOD
09-1150
30 cm



BUIE
09-1151
30 cm



09-1152
38 cm



09-1153
38 cm



KATZENSTEIN
09-1154
9 cm

Biopsy Forceps For Rectum

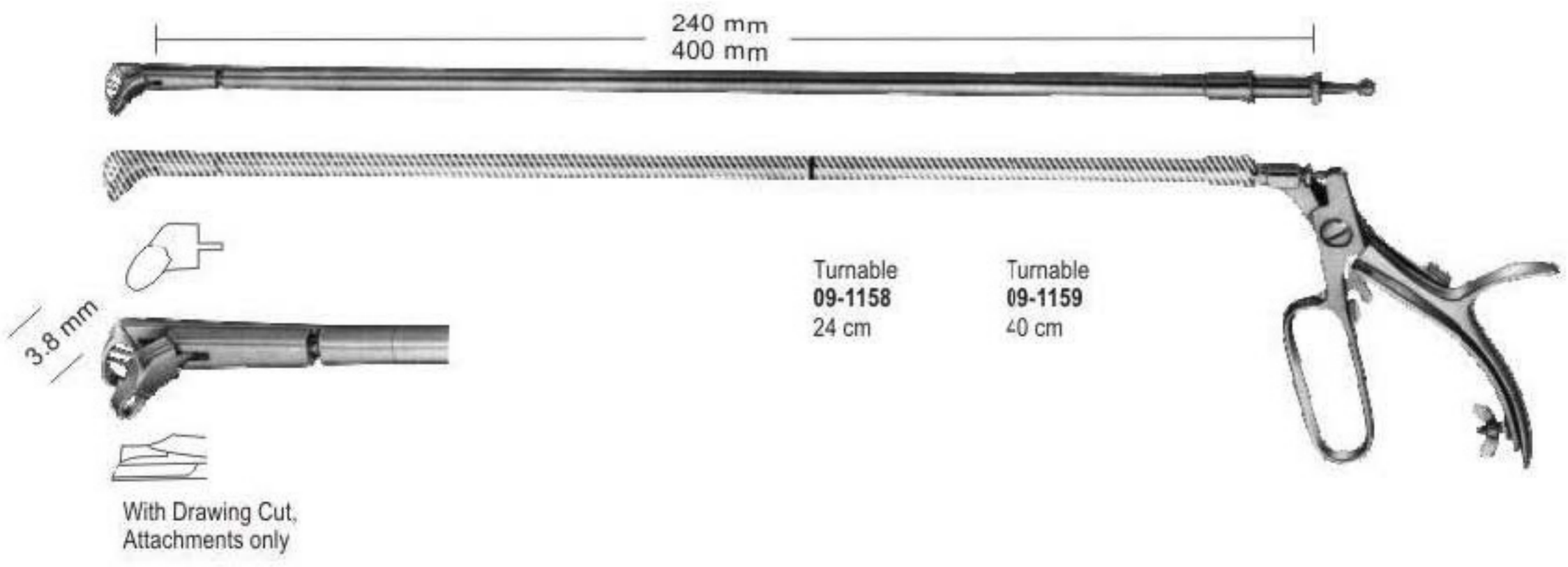
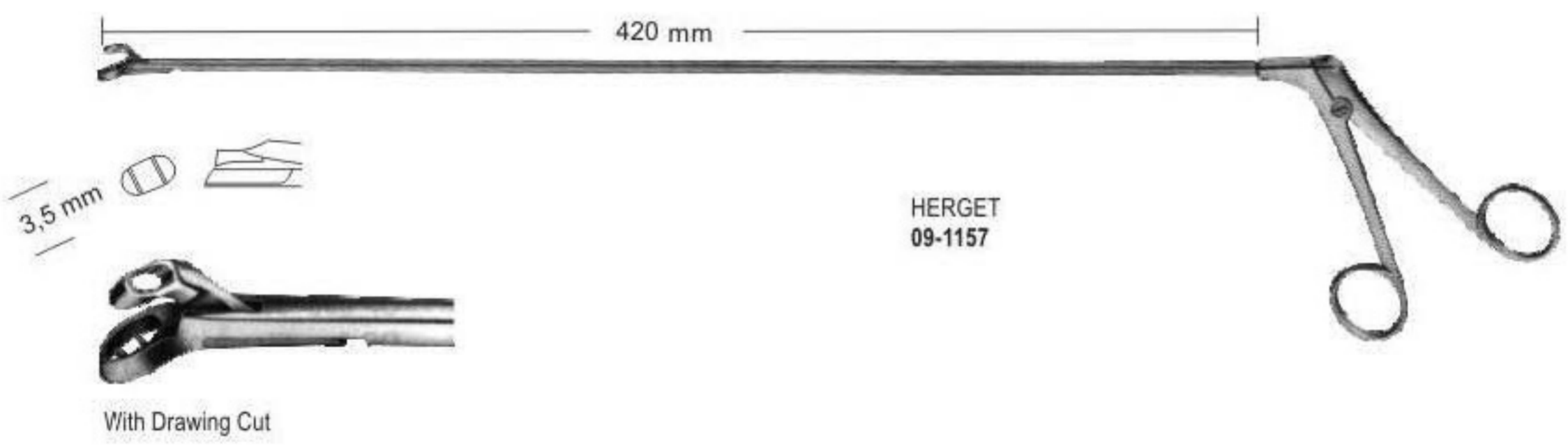
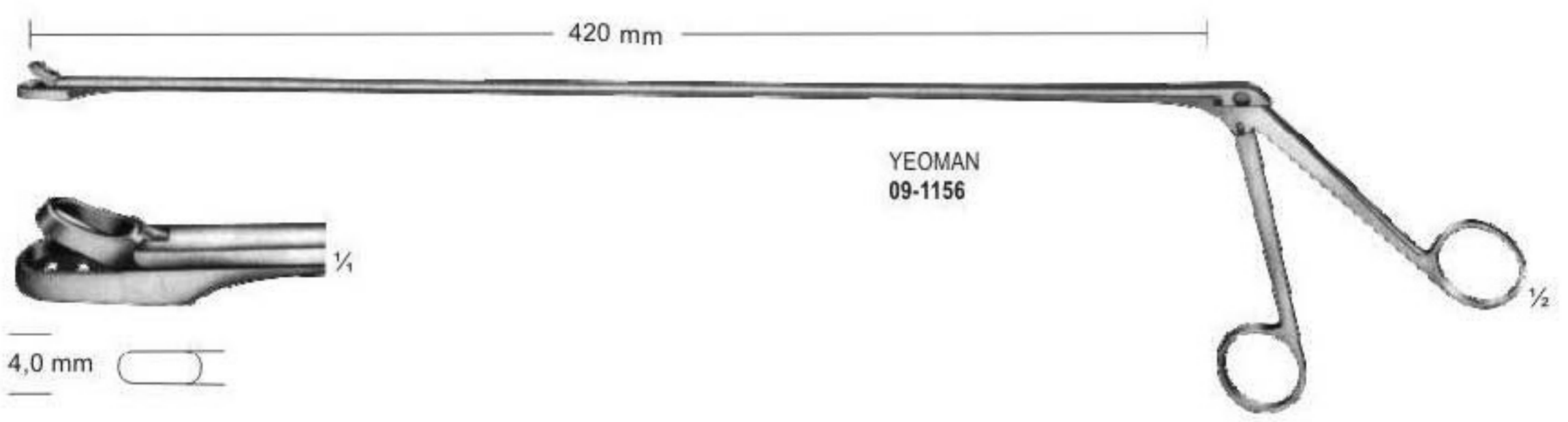
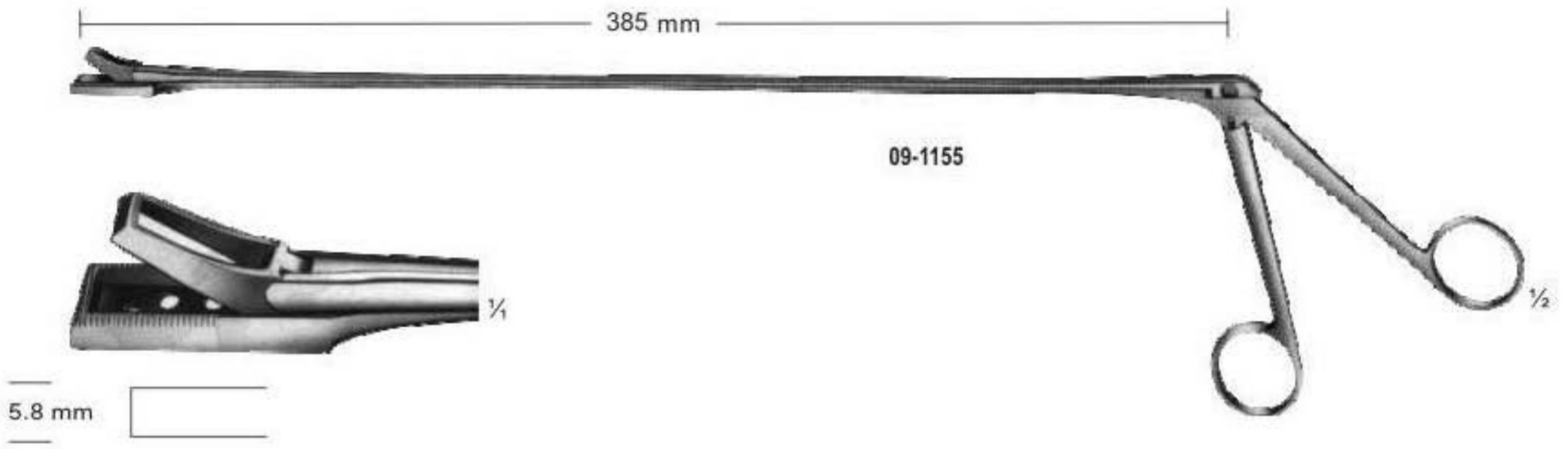

Biopsy Forceps and Swab Holders



3.5 mm

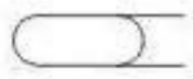

09-1160

3.5 mm



09-1161

4 mm



09-1162

4 mm



09-1163



09-1160 - 09-1163
Handle for 265 - 266 - 267 - 268

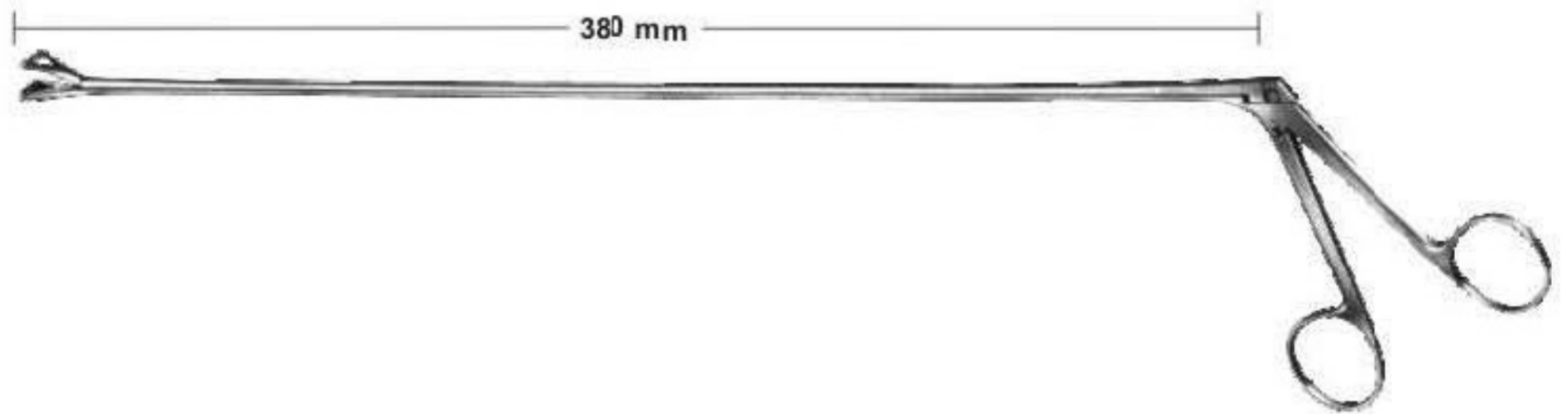

MAULBREITE
JAW WIDTH
09-1164
38 cm
15 mm

Sigmoid Anastomosis Forceps



PARKER-KERR
09-1165
anastomosis forceps
for colon resection
18 cm

DICK
pressure clamps
09-1166 - 09-1169
09-1166 18 cm
09-1167 25.5 cm
09-1168 26.5 cm
09-1169 27.5 cm

LLOYD-DAVIS
09-1170
31.5 cm

Sigmoid Anastomosis Forceps

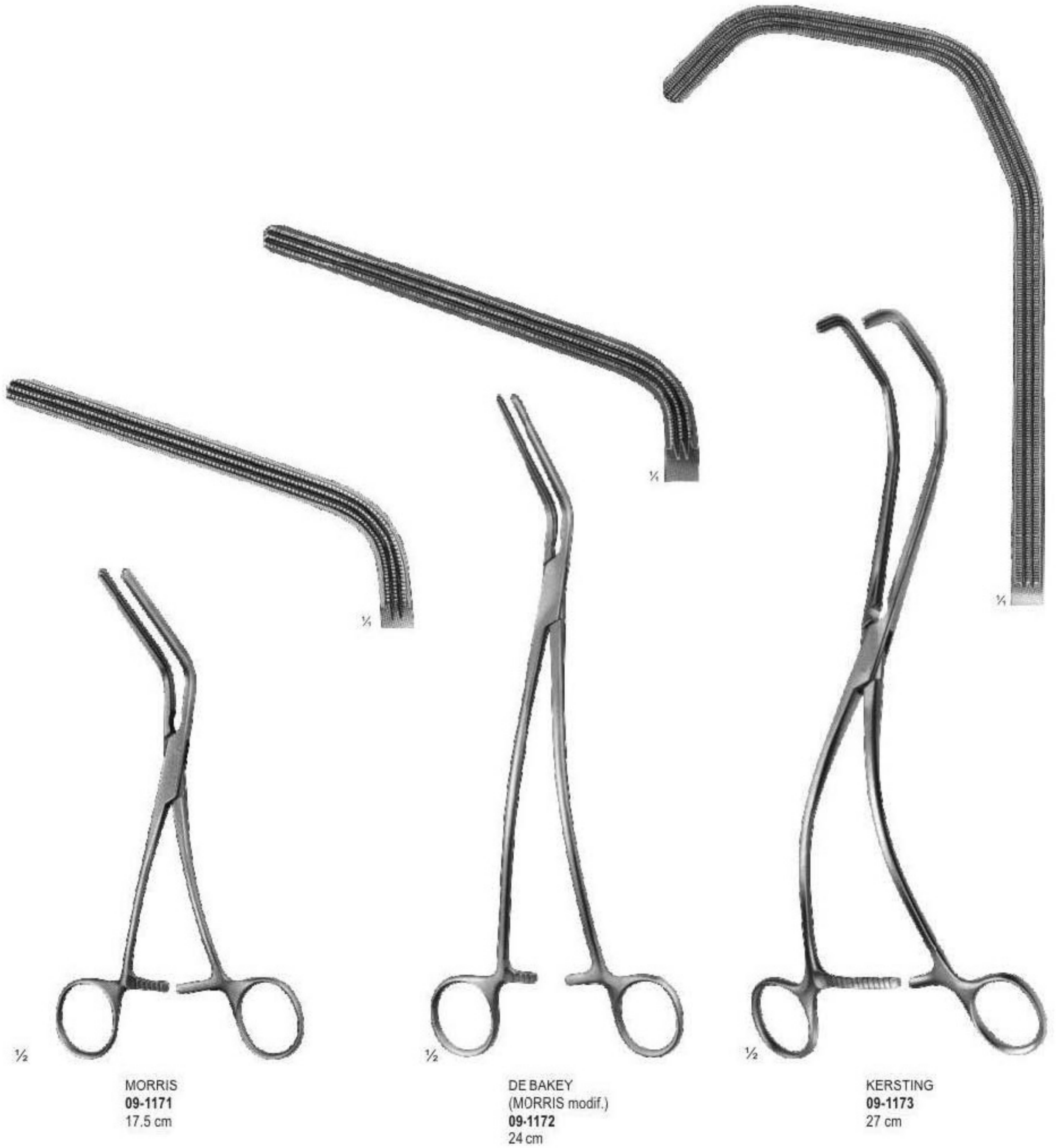

Gastro-intestinal Forceps, Twin



Multi-purpose Clamps

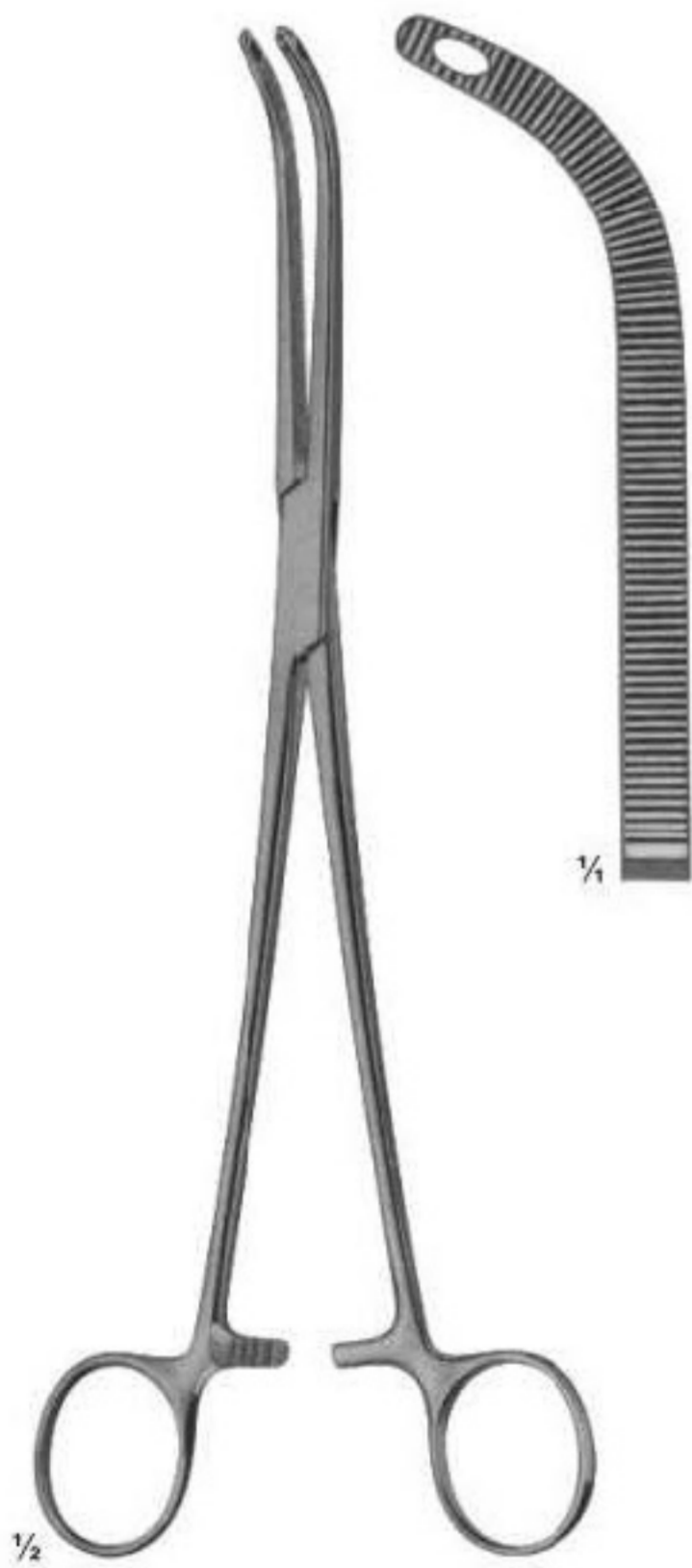

FINOCHIETTO
09-1176
24.5 cm



SEMB
09-1177 - 09-1178
24.4 cm

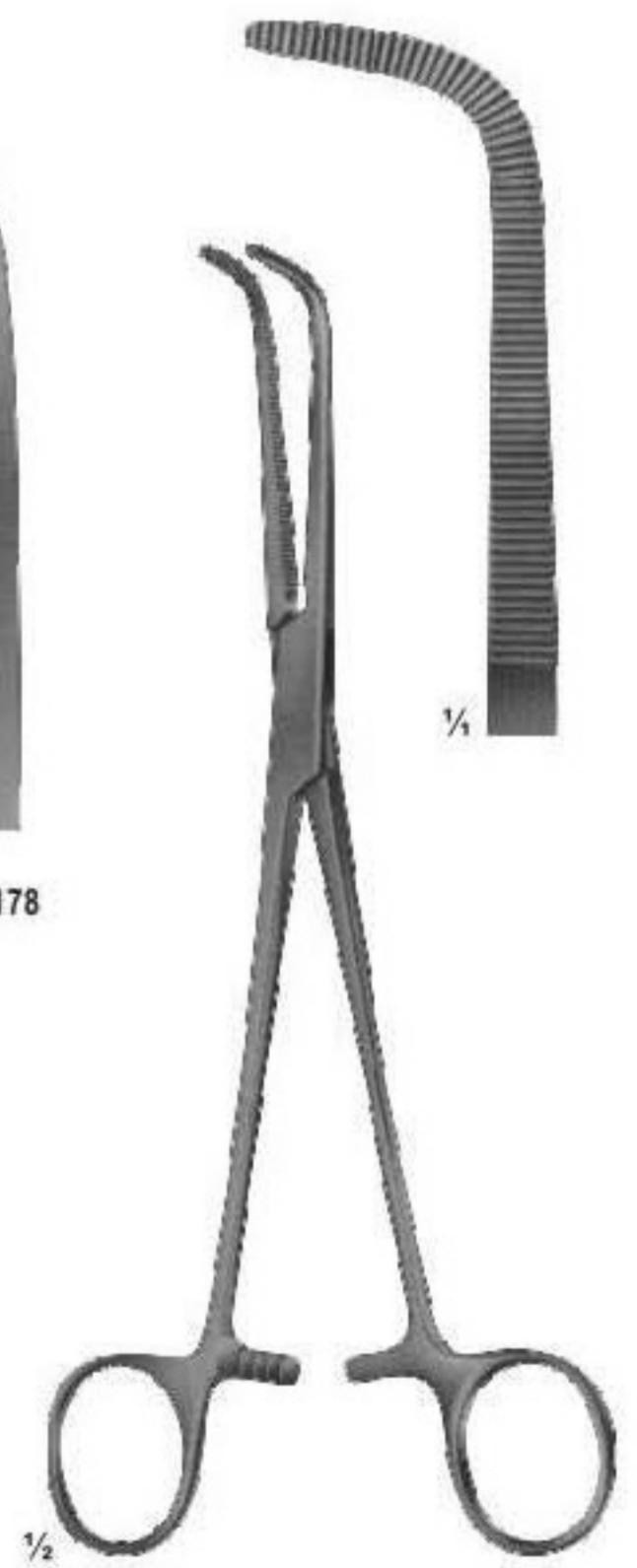

WIKSTROEM
09-1179
20.5 cm

Multi-purpose Clamps

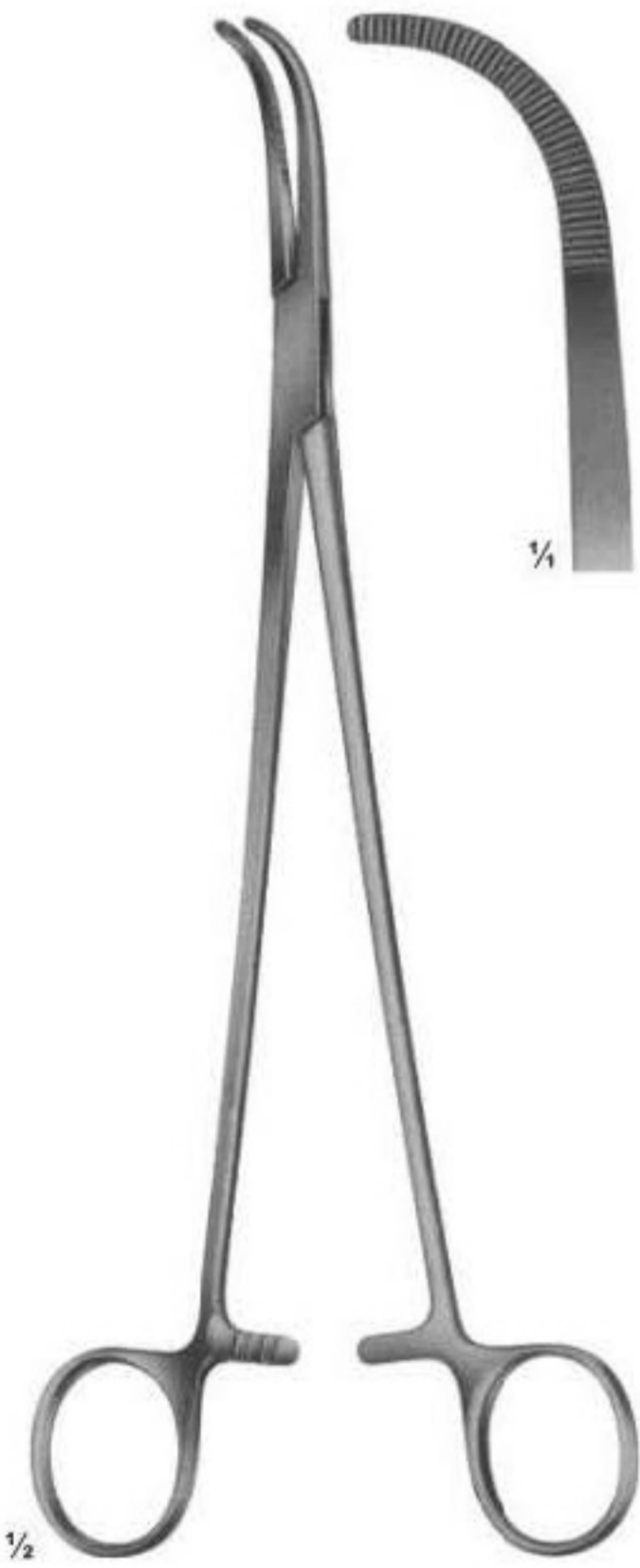

MIXTER
09-1180
23 cm



MIXTER
09-1181 - 09-1183
09-1181 22 cm
09-1182 25 cm

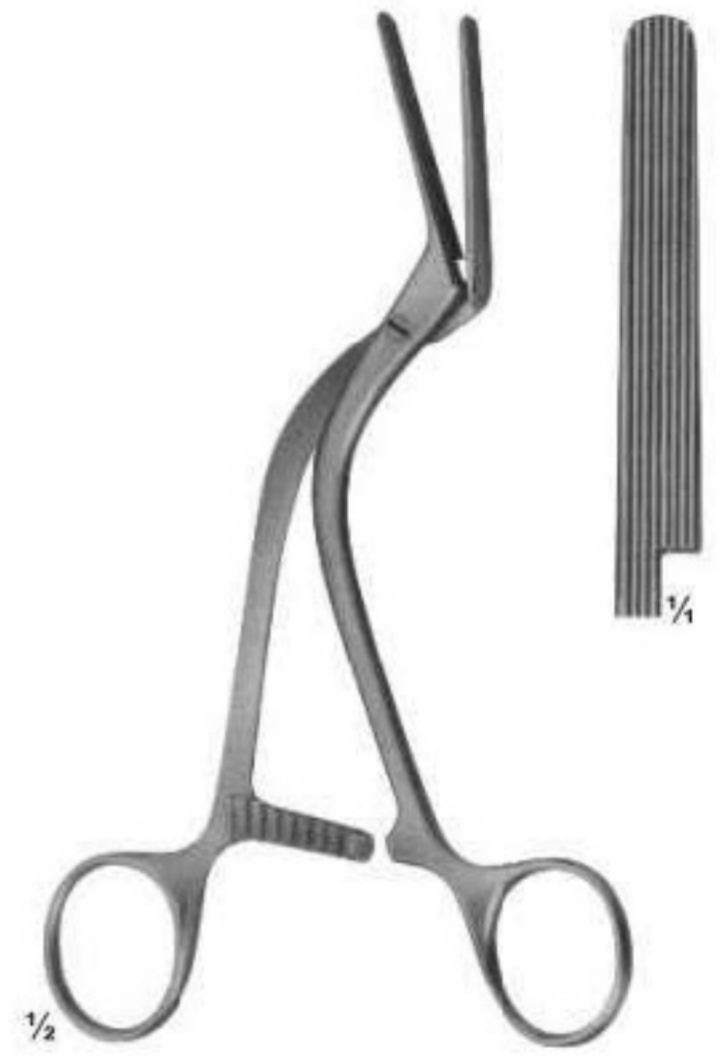

HOPFNER
09-1184
16 cm

Page 215-254



- Muller Vessel Clips & Bulldog Clamps
- Haemostatic Forceps
- Organ Grasping Forceps
- Dressing, Sponge Holding, Organ & Tissue Grasping Forceps
- Delicate Haemostatic Forceps
- Dissecting & Ligature Forceps
- Special Pattern, Tonsil Forceps
- Towel Clamps
- Tendon Seizing Forceps
- Vaginal Clamps & Compression Forceps
- Vaginal Clamps
- Peritoneum Forceps
- Tubing Clamps



Muller Vessel Clips And Bulldog Clamps
Closing Force



18-1046
Straight



80g
50g



18-1048
Curved tips



80g
50g



18-1050
Muller
Knee-bent



80g
50g



18-1062
38 mm



18-1063
48 mm



18-1064
56 mm



18-1065
63 mm



18-1066
75 mm

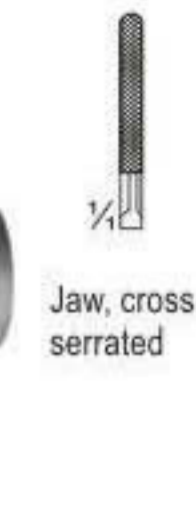

18-1067
80 mm



18-1068
90 mm

Jaw, cross
serrated



18-1052
35 mm



18-1053
35 mm



18-1054
45 mm



18-1055
45 mm



DIEFFENBACH

18-1056
38 mm



DIEFFENBACH

18-1057
48 mm



DIEFFENBACH

18-1058
38 mm



DIEFFENBACH

18-1059
48 mm



DIEFFENBACH

18-1060
58 mm



DIEFFENBACH

18-1061
58 mm



JOHNS-HOPKINS

18-1062 - 18-1068
91 mm

- 18-1062** 38 mm
- 18-1063** 48 mm
- 18-1064** 56 mm
- 18-1065** 63 mm
- 18-1066** 75 mm
- 18-1067** 80 mm
- 18-1068** 90 mm

DE BAKEY



18-1070
Length
50 mm
Jaws
27 mm

DE BAKEY



18-1071
Length
48 mm
Jaws
27 mm



GLOVER
18-1072
Length
57 mm
Jaws
35 mm



DE BAKEY
18-1073
Length 73 mm
Jaws 38 mm



DE BAKEY
18-1074
Length 99 mm
Jaws 63 mm



DE BAKEY
18-1075
Length 95 mm
Jaws 54 mm



DE BAKEY

18-1076
L. 80 mm



DE BAKEY

18-1077
L. 90 mm



DE BAKEY

18-1078
L. 105 mm



DE BAKEY

18-1079
L. 124 mm



DE BAKEY

18-1080
L. 78 mm



DE BAKEY

18-1081
L. 86 mm



DE BAKEY

18-1082
L. 97 mm

18-1083
L. 114 mm

18-1084
L. 68 mm

18-1085
L. 96 mm

18-1086
L. 117 mm

18-1087
L. 65 mm

18-1088
L. 91 mm

18-1089
L. 110 mm

Haemostatic Forceps

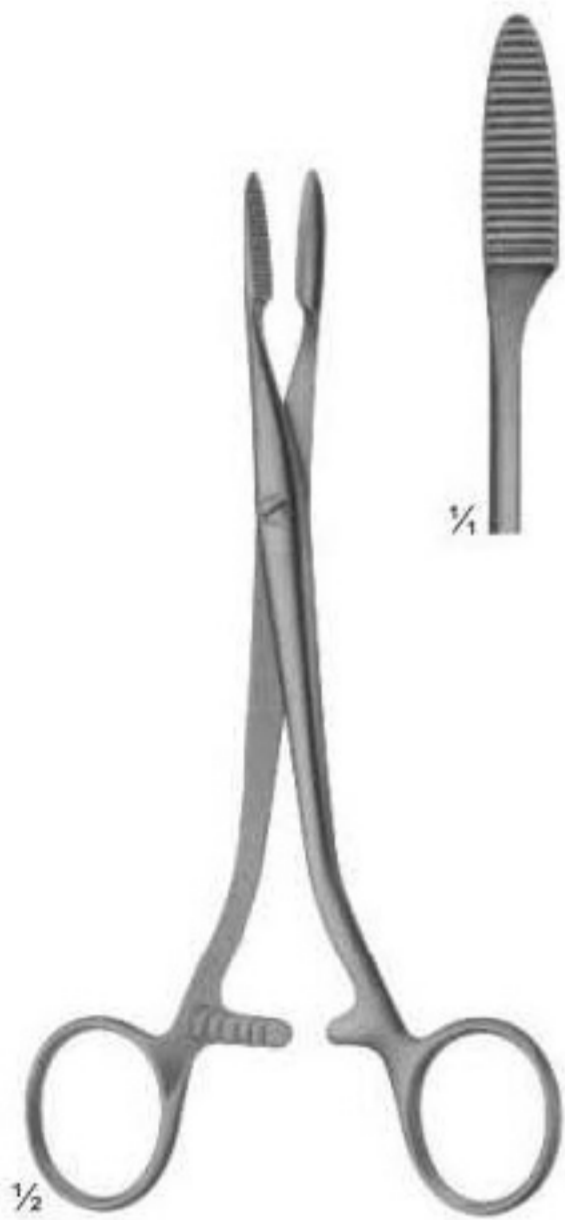

PEAN
10-1001 16 cm
10-1002 18 cm

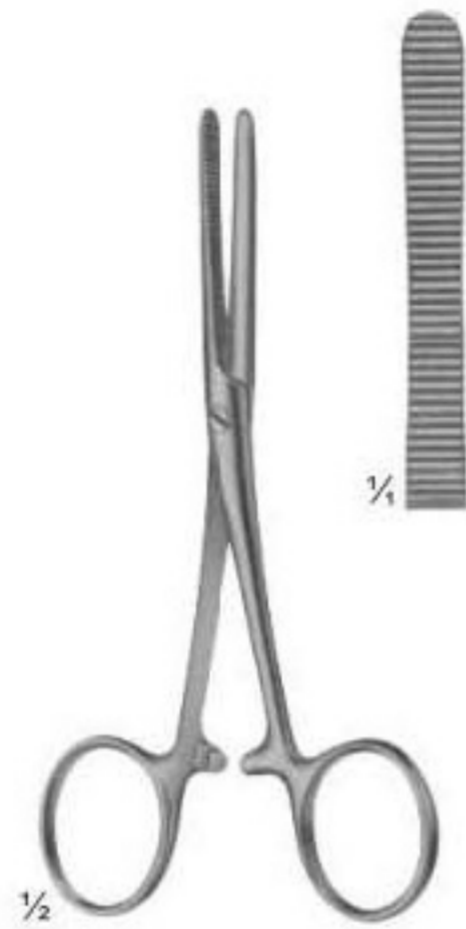

PEAN
10-1003 12.5 cm

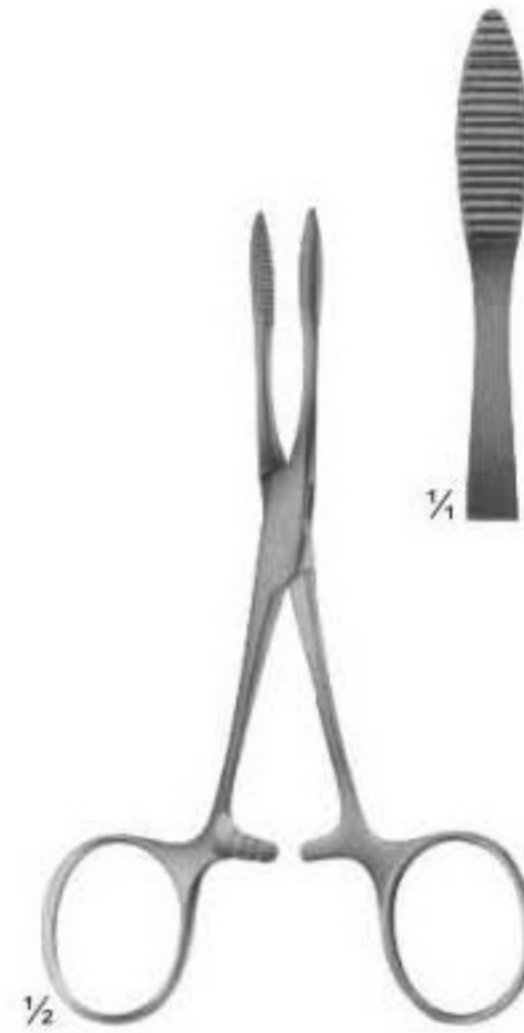

PEAN
10-1004 12.5 cm
10-1005 14 cm

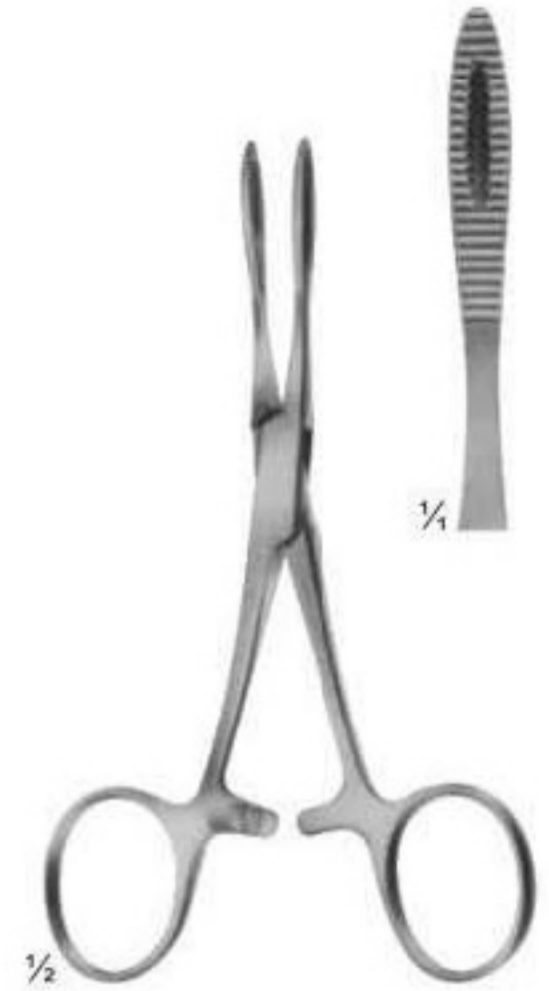

KRONLEIN
10-1006 13 cm



SPENCER-WELLS
10-1007 - 10-1013
10-1007 13 cm
10-1008 14 cm
10-1009 15 cm
10-1010 18 cm
10-1011 20 cm
10-1012 25 cm
10-1013 30 cm

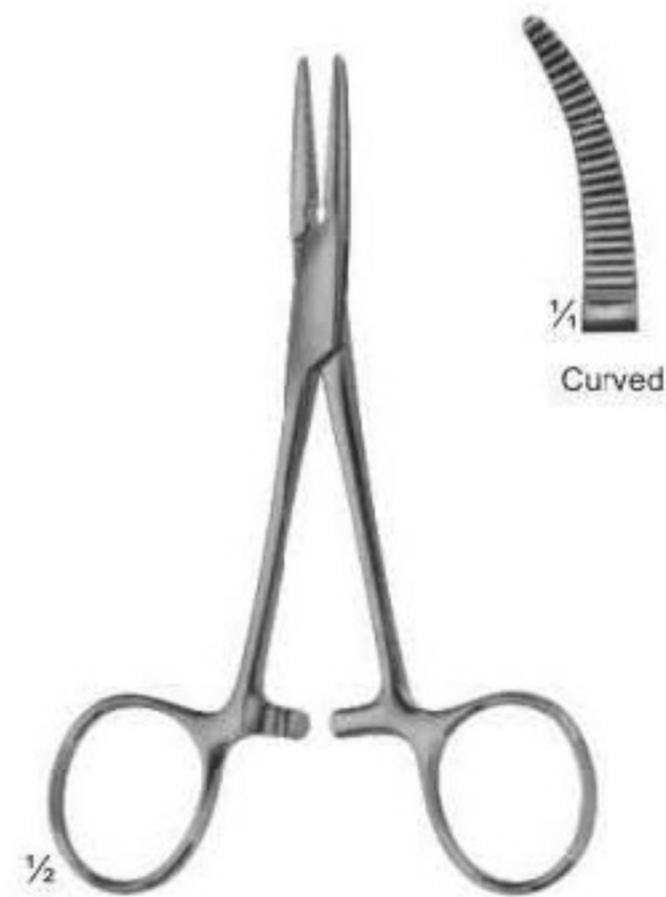

SPENCER-WELLS
10-1014 - 10-1020
10-1014 13 cm
10-1015 14 cm
10-1016 15 cm
10-1017 18 cm
10-1018 20 cm
10-1019 25 cm
10-1020 30 cm

Haemostatic Forceps, Organ Grasping Forceps



CHAPUT
10-1021
2 X 3 teeth, sharp
12.5 cm

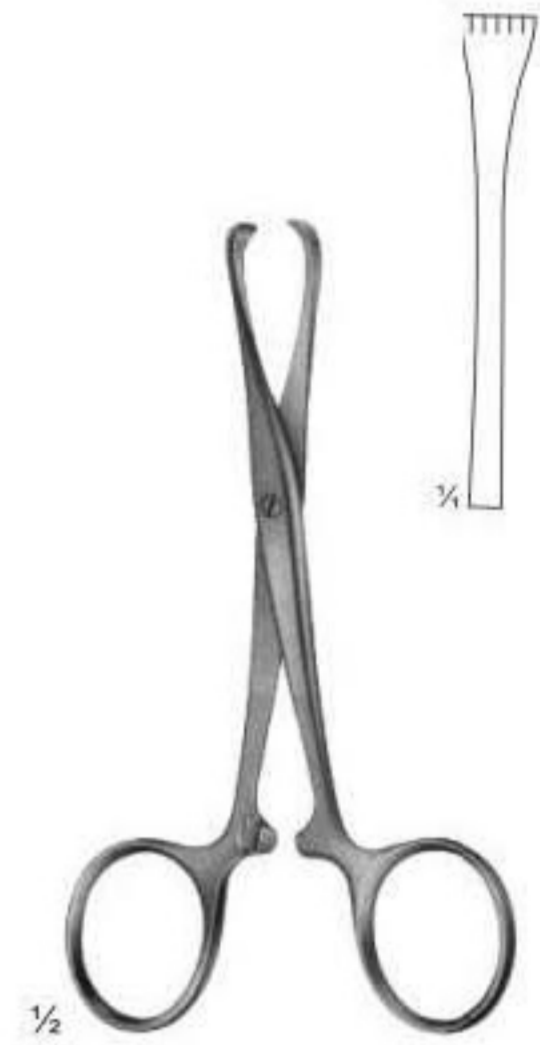

TUFFIER
10-1022
5 X 6 teeth, sharp
12.5 cm

ATRAUMA



10-1023 - 10-1024



10-1023
25 cm



10-1024
27 cm

Dressing, Sponge Holding, Organ And Tissue Grasping Forceps

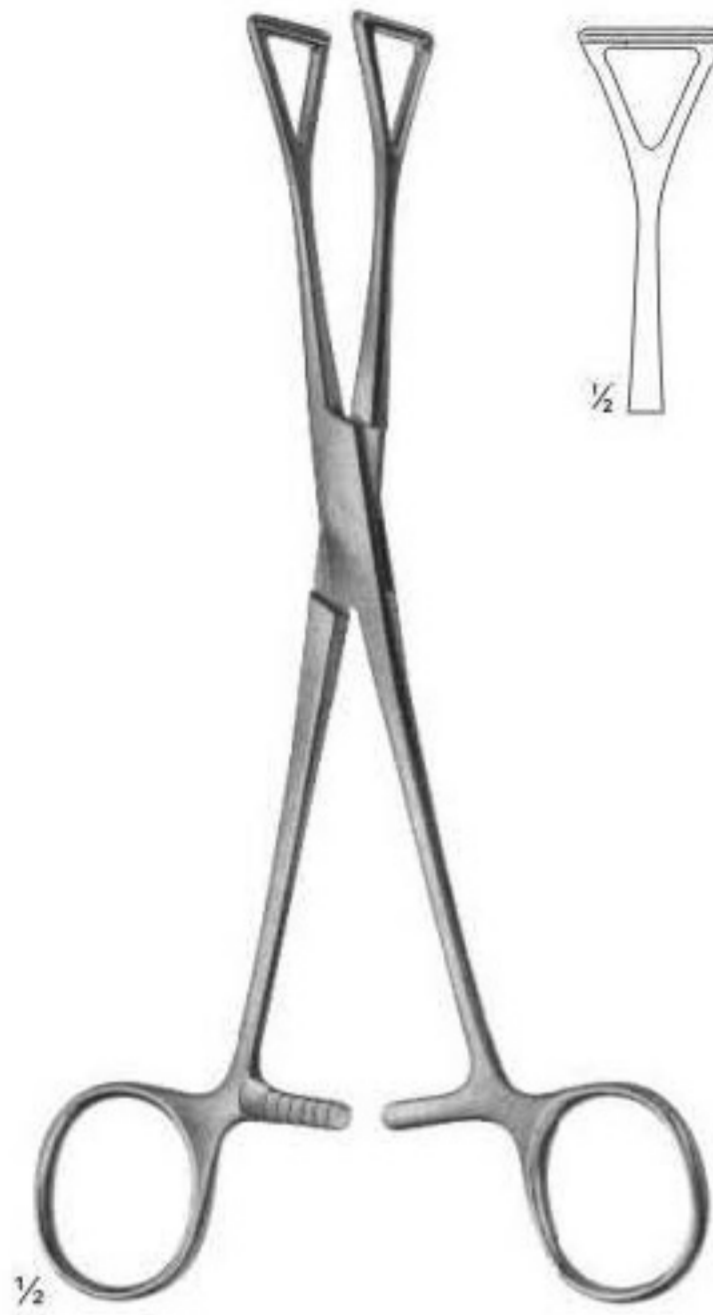

COLLIN
10-1025 20 cm
10-1026 23 cm



PRATT
10-1027
15 cm



MARTEL-REES
10-1028
13.5 cm

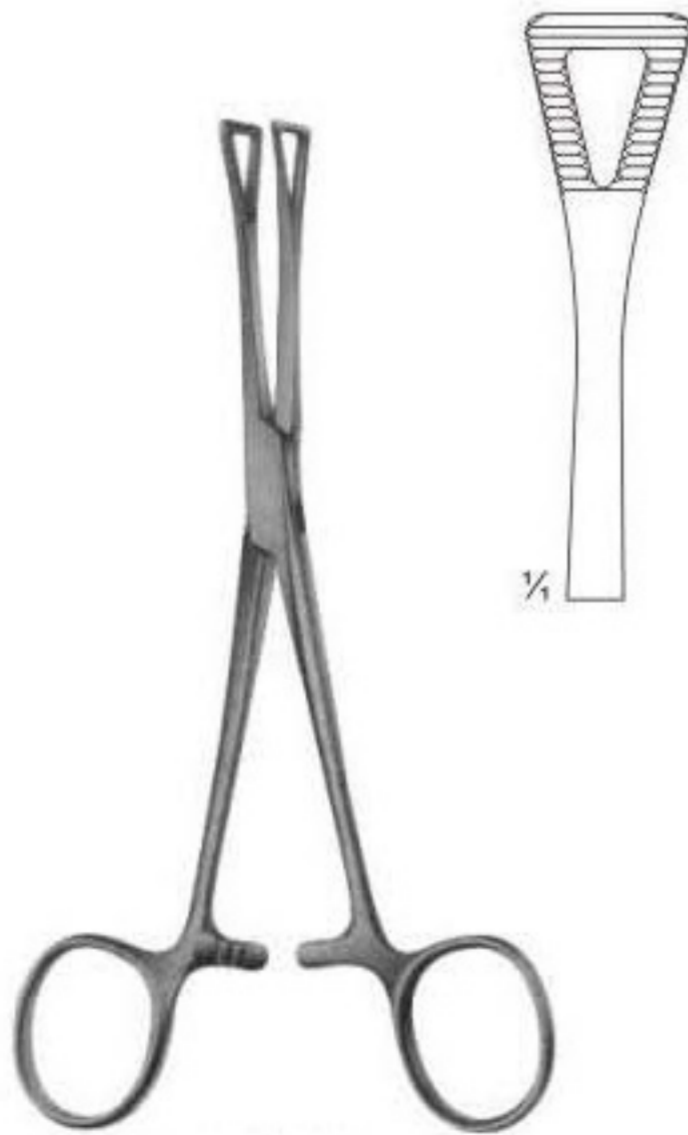

PENNINGTON
10-1029 15.5 cm
10-1030 21 cm



COLLIN
10-1031 16 cm
10-1032 17 cm

Delicate Haemostatic Forceps



CARREL
10-1033
8.5 cm

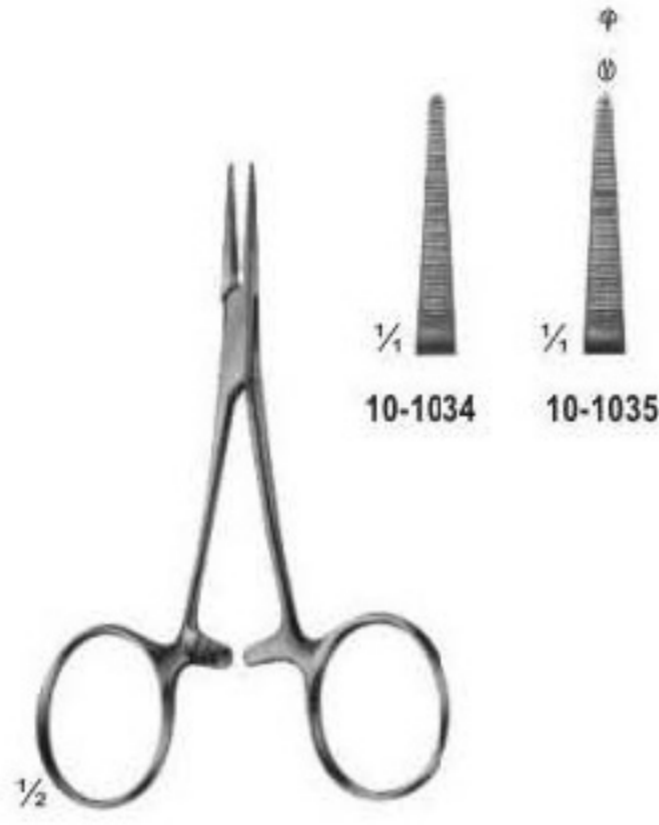

BABY-MOSQUITO
(HARTMANN)
10-1034 - 10-1035
10 cm



BABY-MOSQUITO
(HARTMANN)
10-1036 - 10-1037
10 cm



MICRO-HALSTED
10-1038 12.5 cm
10-1039 14 cm

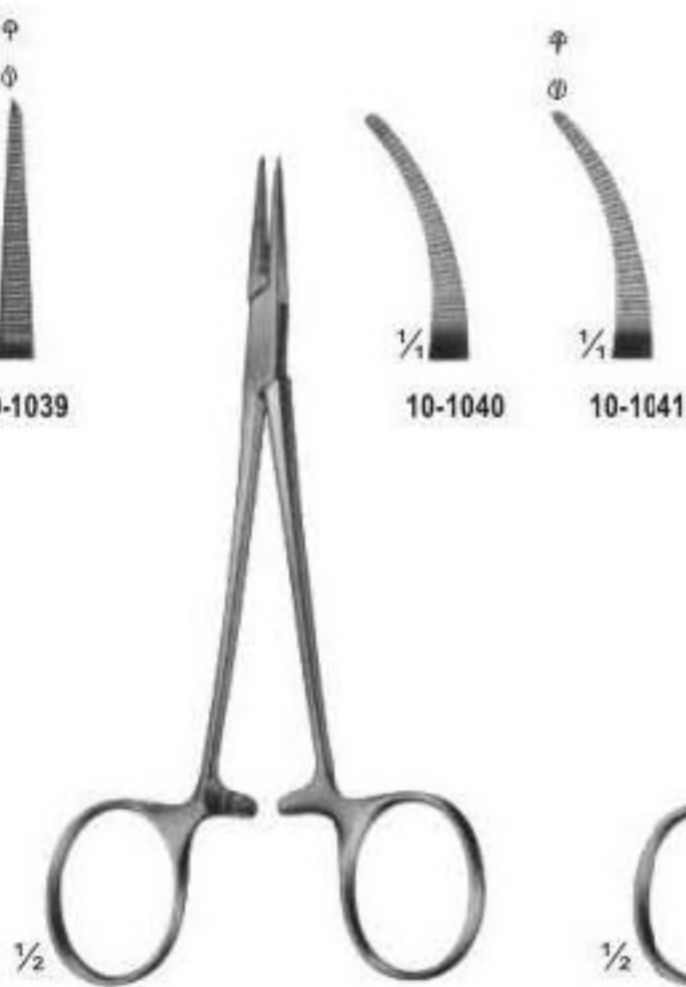

MICRO-HALSTED
10-1040 12.5 cm
10-1041 14 cm



HALSTED-MOSQUITO
10-1042 12.5 cm
10-1043 14 cm

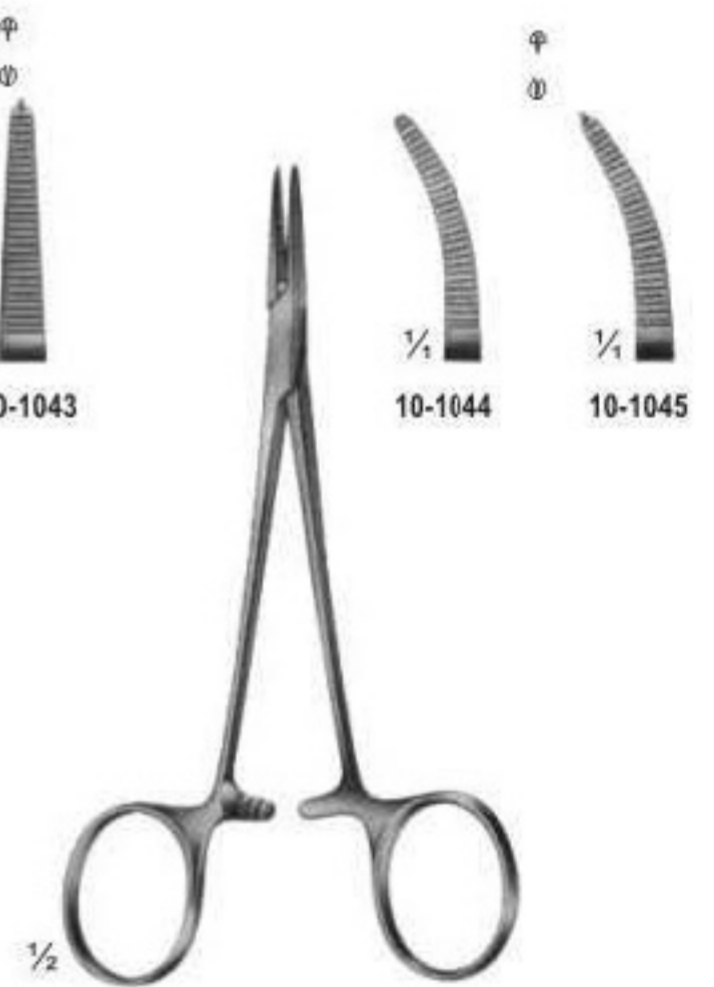

HALSTED-MOSQUITO
10-1044 12.5 cm
10-1045 14 cm

Delicate- and Ligature Forceps



MICRO-ADSON
10-1046 12 cm
10-1047 14 cm



BABY-ADSON
10-1048 12 cm
10-1049 14 cm



BABY-OVERHOLT
10-1050
13 cm



BABY-MIXTER
10-1051
13 cm

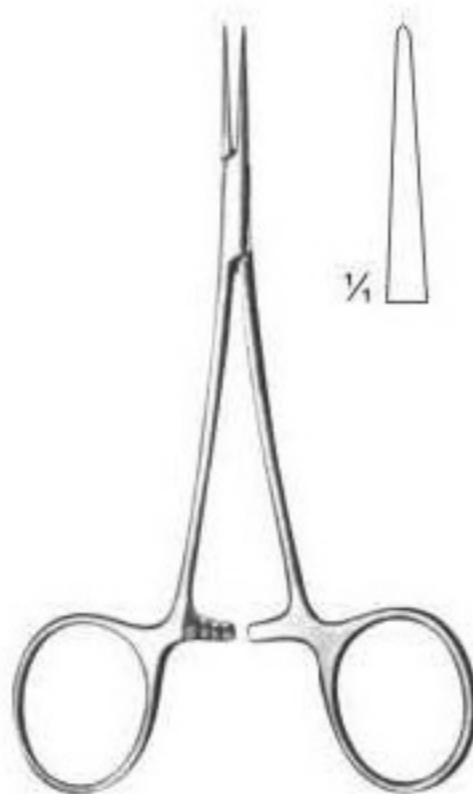

LIGTURE-FORCEP
10-1052
12.5 cm

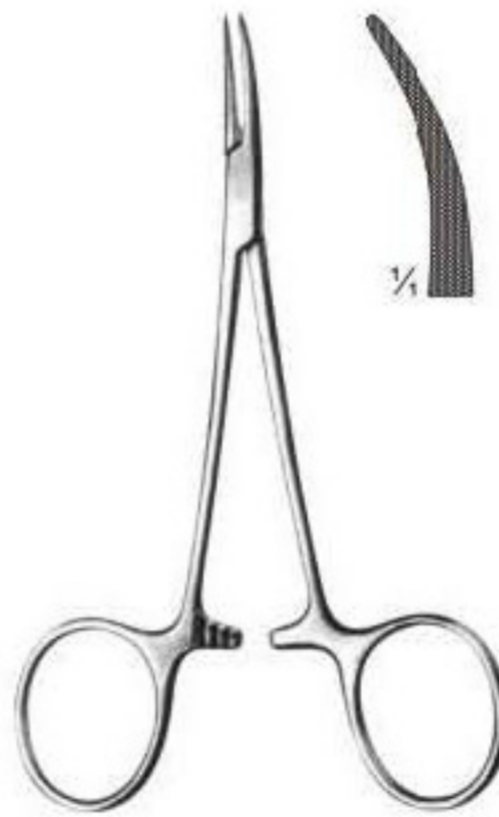

LIGTURE-FORCEP
10-1053
12.5 cm



OVERHOLT-MINI
10-1054
15 cm

Delicate Haemostatic Forceps

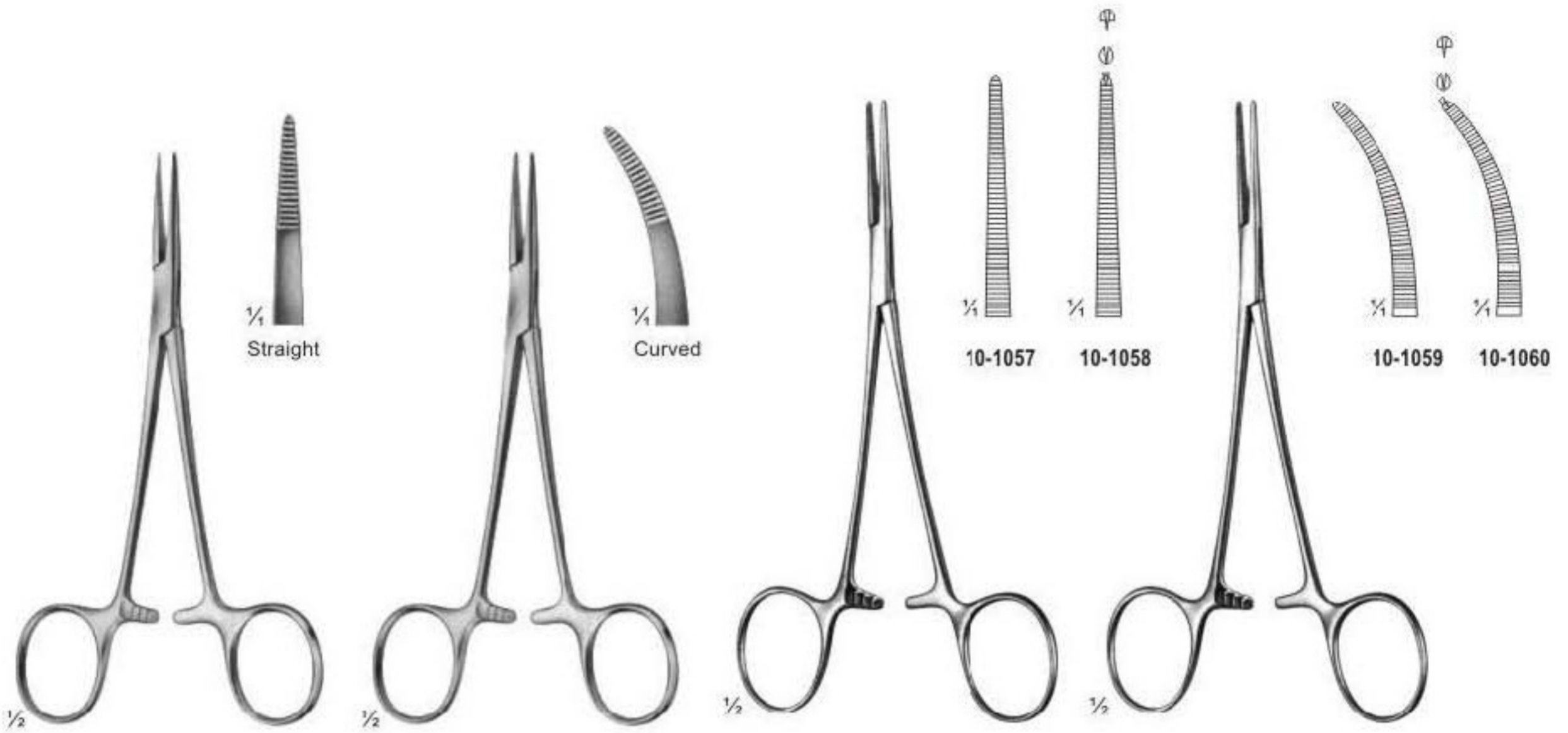

PROVIDENCE-HOSPITAL
10-1055
14 cm

PROVIDENCE-HOSPITAL
10-1056
14 cm

LERICHE
10-1057 15.5 cm
10-1058 15 cm

LERICHE
10-1059 15.5 cm
10-1060 15 cm

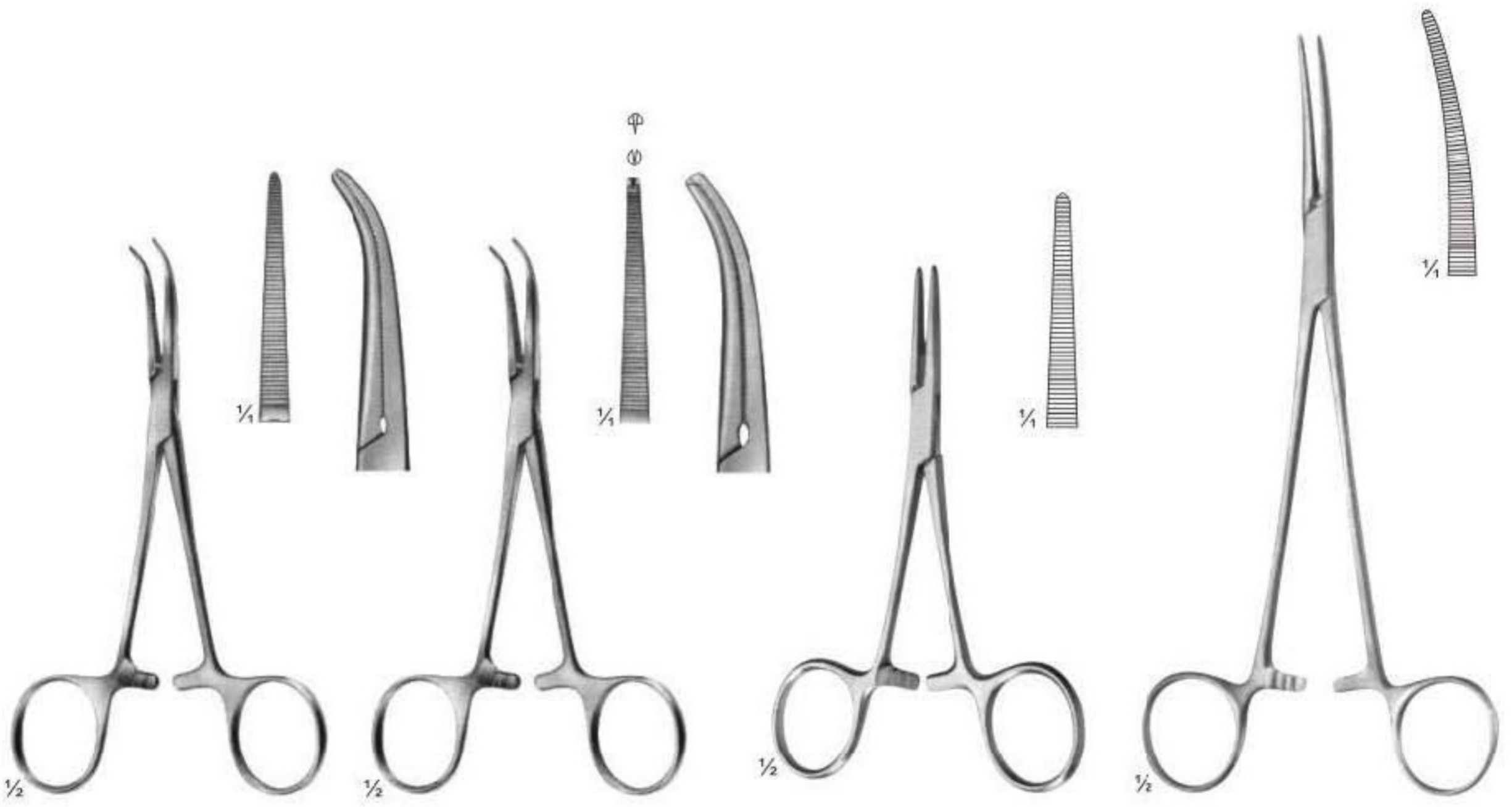

DANDY
10-1061 12 cm
10-1062 14 cm

DANDY
10-1063 12 cm
10-1064 14 cm

DUNHILL
10-1065
12.5 cm

DUNHILL
10-1066
18.5 cm

Delicate Haemostatic Forceps



KELLY
10-1067
14 cm

KELLY
10-1068
14 cm

KELLY-RANKIN
10-1069
16 cm

KELLY-RANKIN
10-1070
16 cm

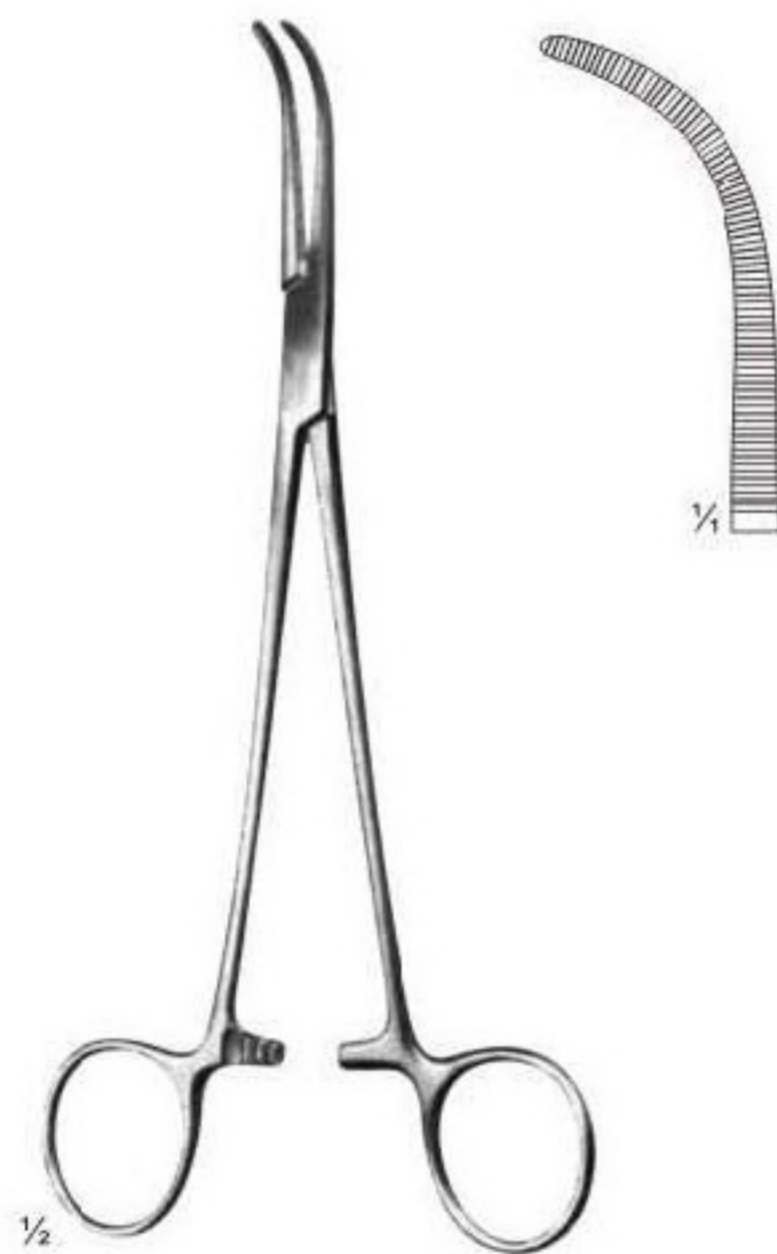

OBWEGESER
10-1071
19 cm



LOVELACE
10-1072
19 cm

Delicate Haemostatic Forceps

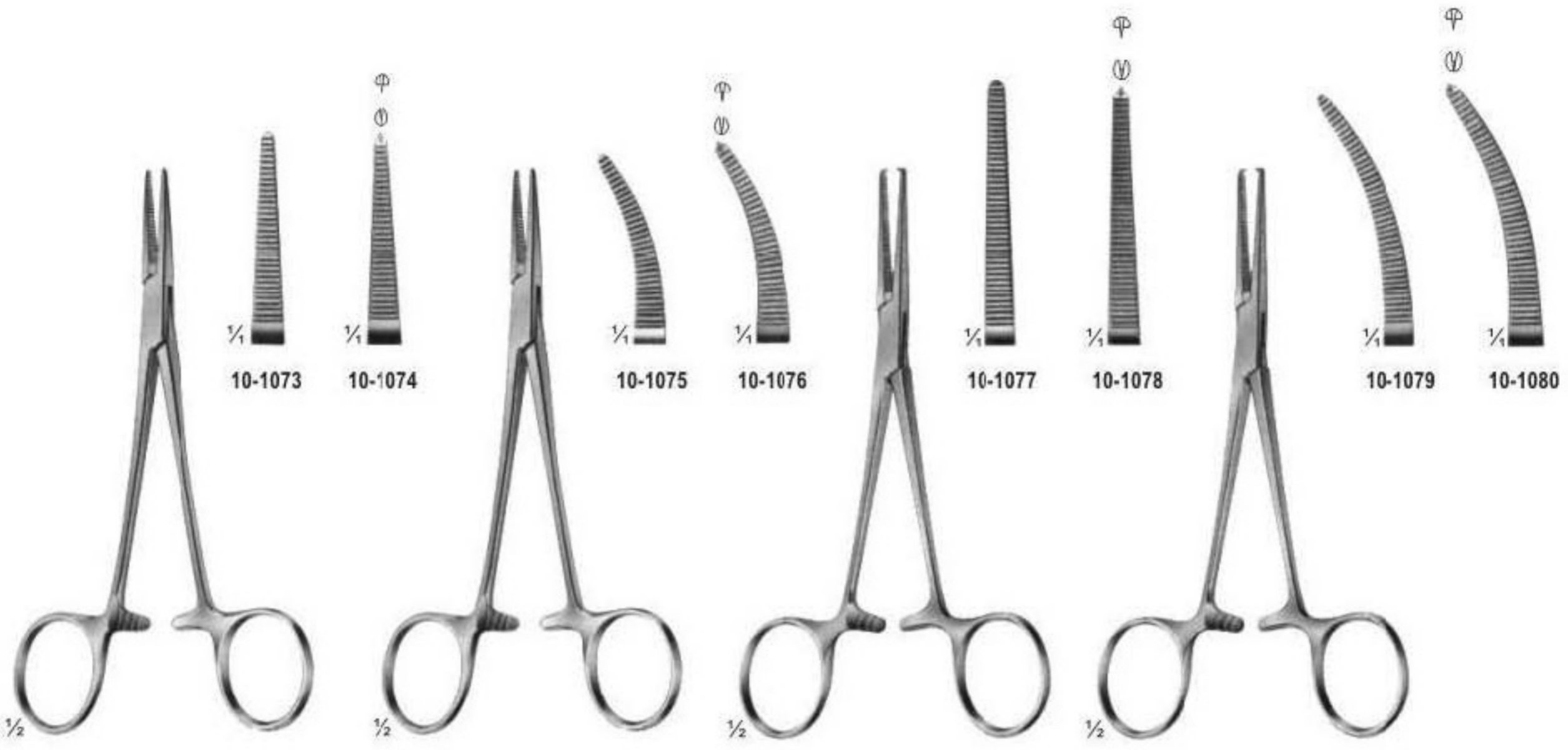

BABY-CRILE
10-1073 - 10-1074
14 cm

BABY-CRILE
10-1075 - 10-1076
14 cm

CRILE
10-1077 - 10-1078
14 cm

CRILE
10-1079 - 10-1080
14 cm

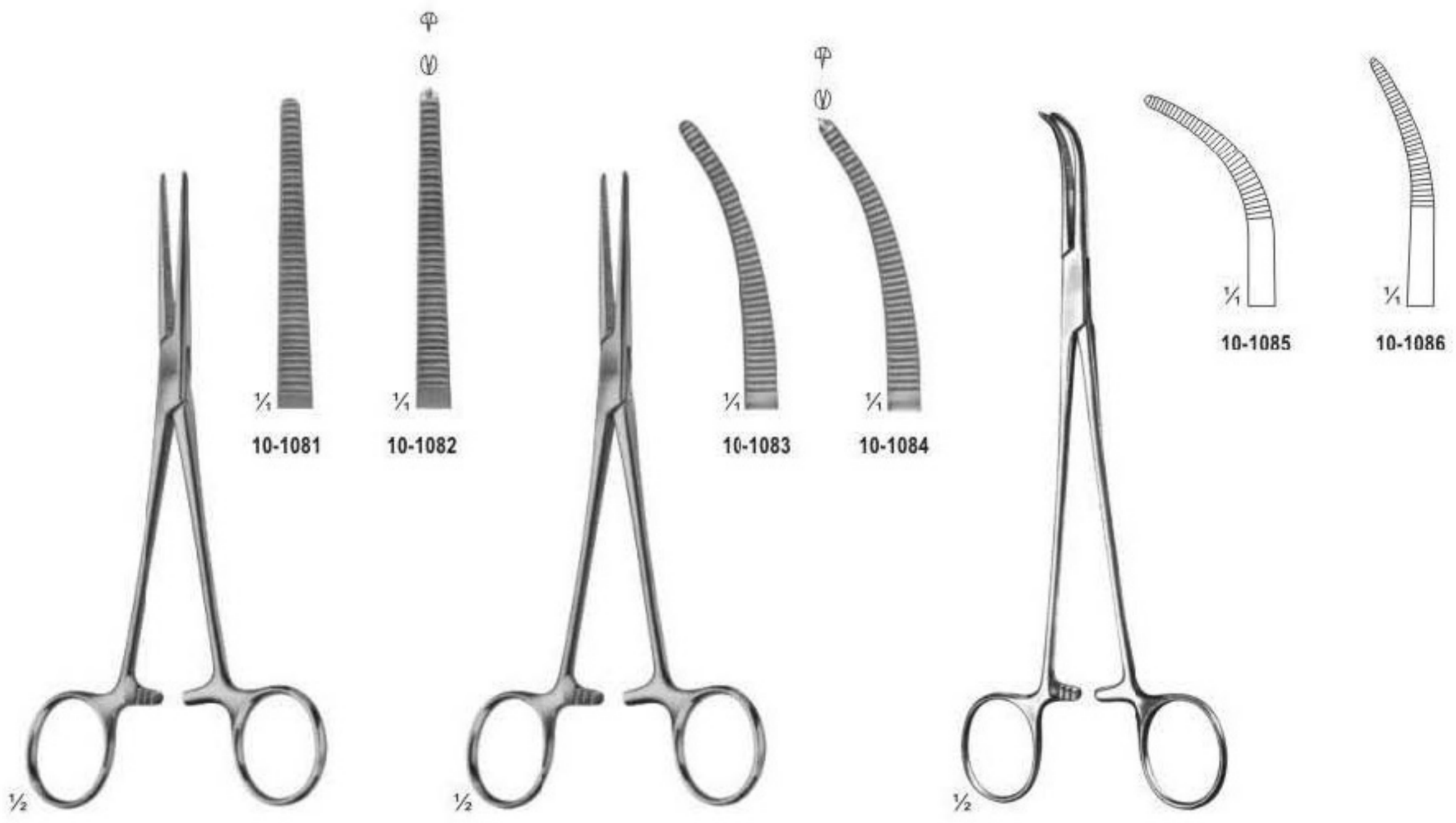

CRILE-RANKIN
10-1081 - 10-1082
16 cm

CRILE-RANKIN
10-1083 - 10-1084
16 cm

SCHNIDT
10-1085 18 cm
10-1086 19 cm

Delicate Haemostatic Forceps



HALSTED-MOSQUITO
10-1087 18 cm
10-1088 21 cm

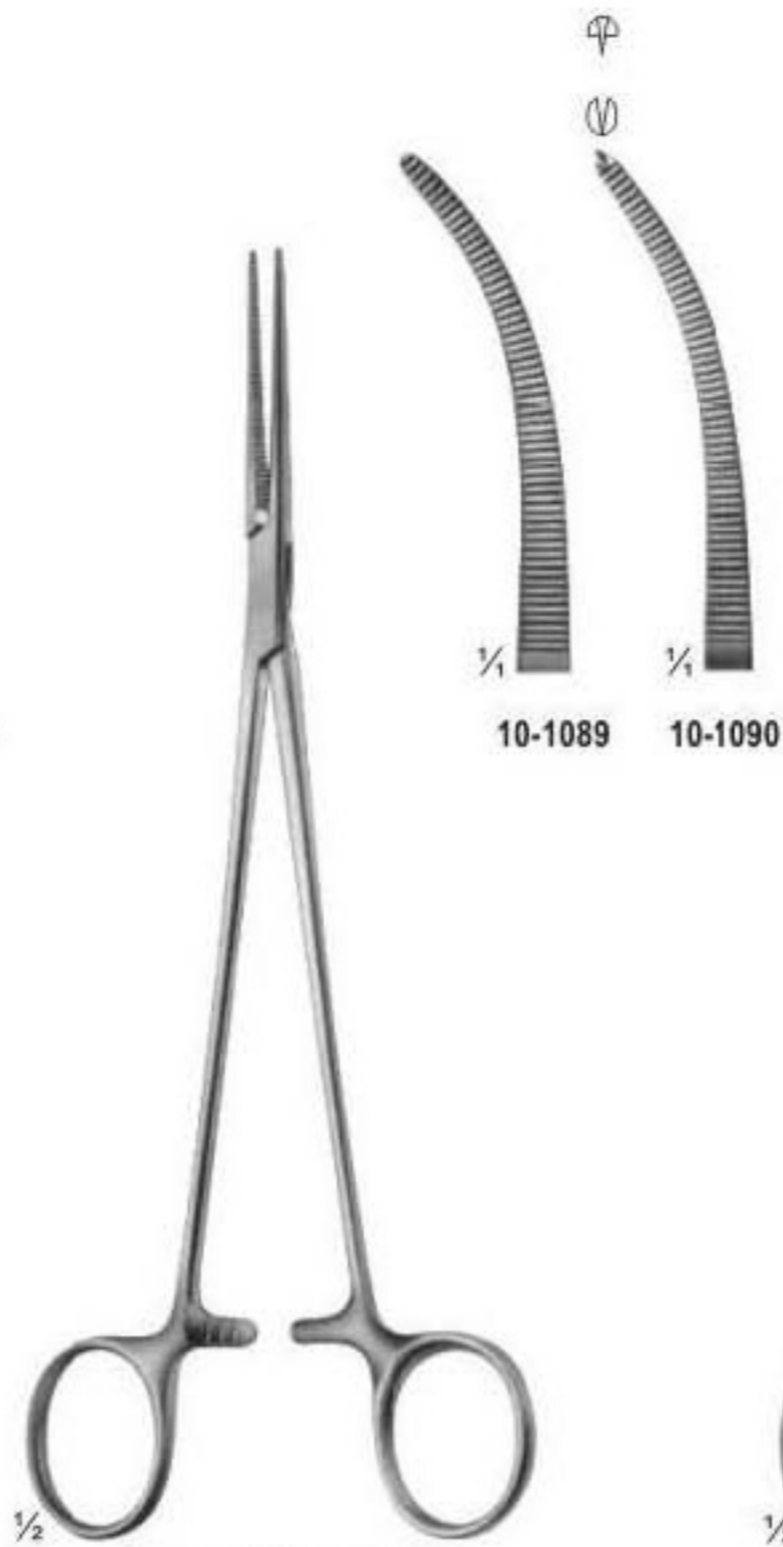

HALSTED-MOSQUITO
10-1089 18 cm
10-1090 21 cm

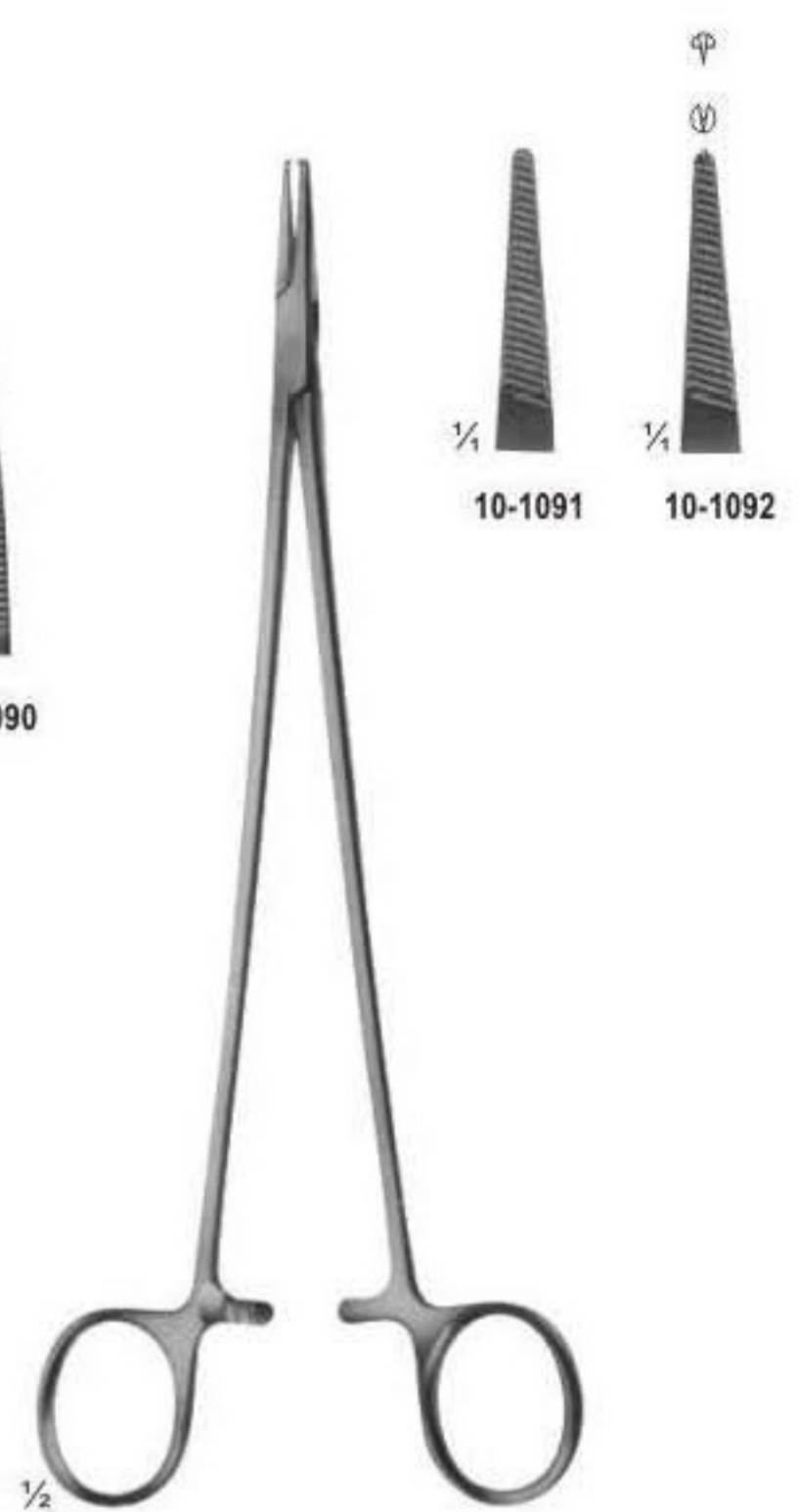

HALSTED
10-1091 - 10-1092
21.5 cm



MARTIN-FUCHSIG
10-1093
20 cm



ROCHESTER-CARMALT
10-1094 17 cm
10-1095 20 cm



ROCHESTER-CARMALT
10-1096 16cm
10-1097 20 cm

Delicate Haemostatic Forceps



BENGOLEA
10-1098 - 10-1101



1/4
Straight
10-1098
20 cm
10-1099
26 cm



1/4
Straight
10-1100
20 cm
10-1101
26 cm



1/2
BENGOLEA
10-1102 - 10-1105



1/4
Curved
10-1102
20 cm
10-1103
26 cm



1/4
Curved
10-1104
20 cm
10-1105
26 cm

Haemostatic Forceps

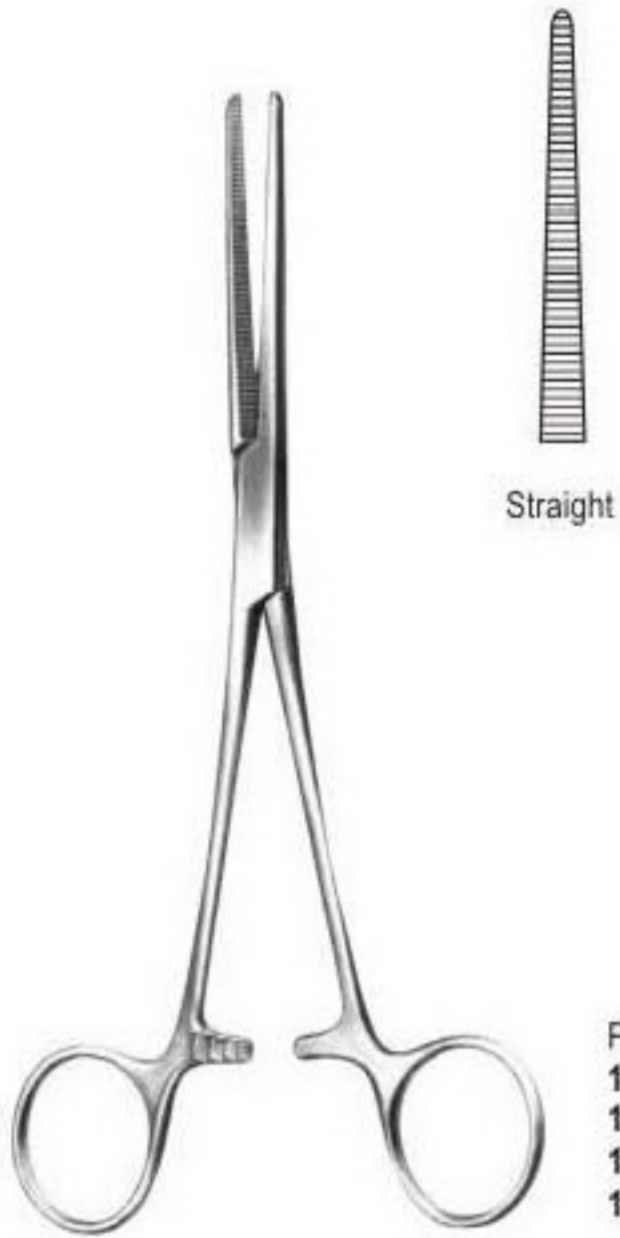

PEAN
10-1106 - 10-1108
10-1106 13 cm
10-1107 14 cm
10-1108 17 cm

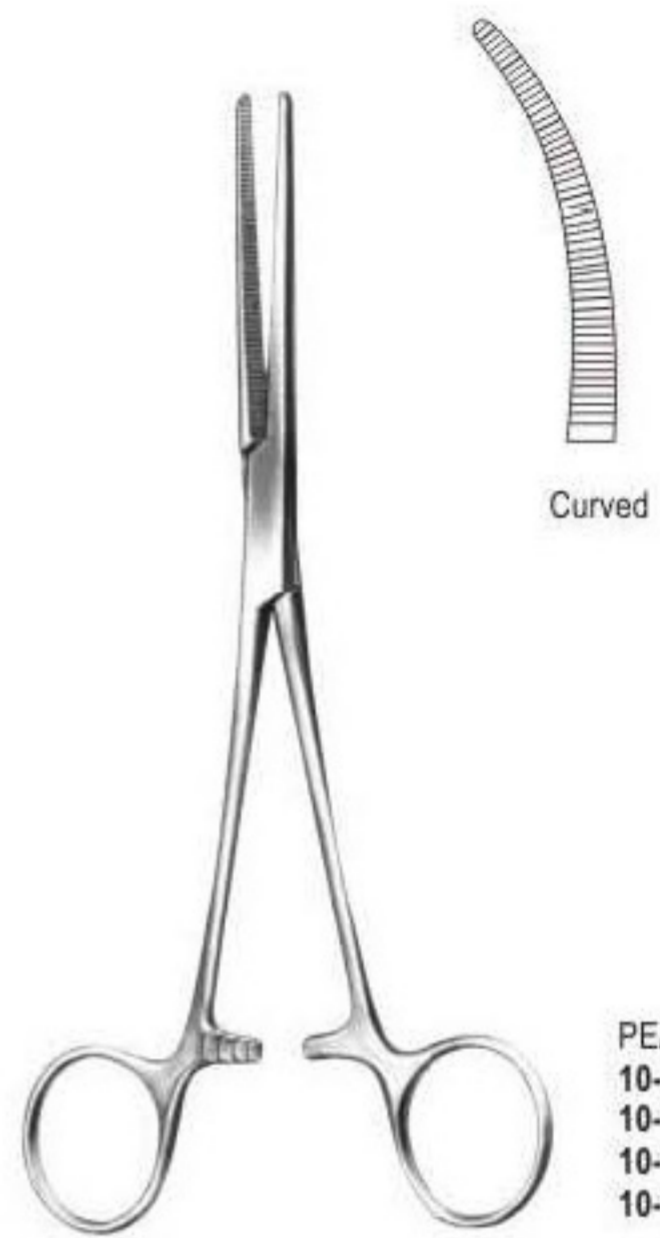

PEAN
10-1109 - 10-1111
10-1109 13 cm
10-1110 14 cm
10-1111 17 cm

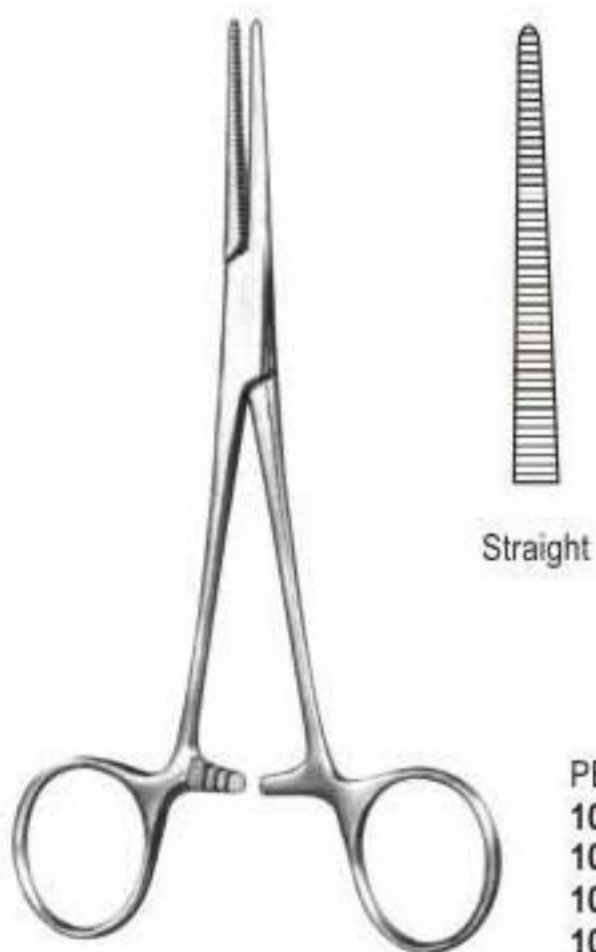

PEAN-Delicate
10-1112 - 10-1114
10-1112 14 cm
10-1113 16 cm
10-1114 18 cm

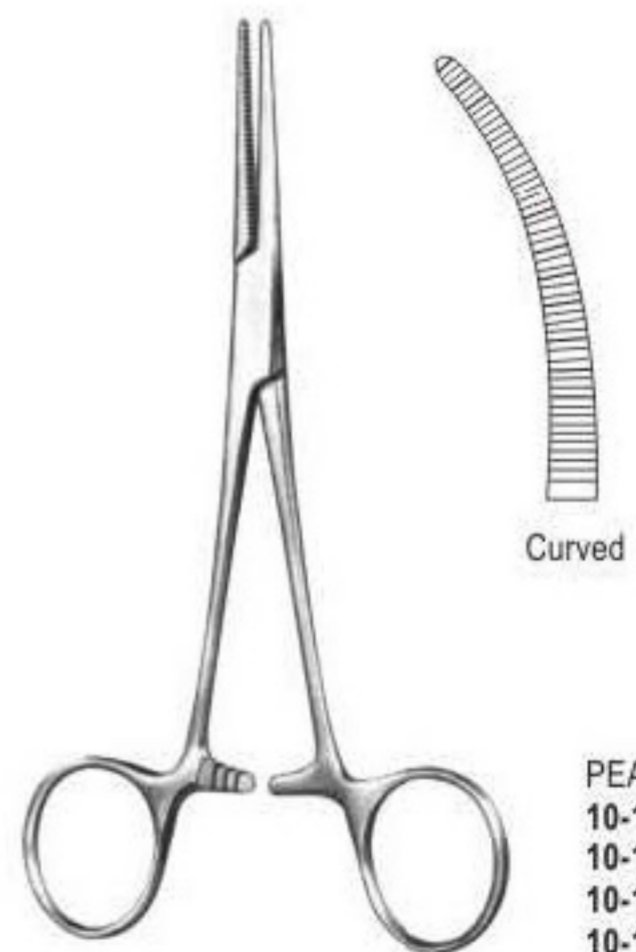

PEAN-Delicate
10-1115 - 10-1117
10-1115 14 cm
10-1116 16 cm
10-1117 18 cm

Haemostatic Forceps

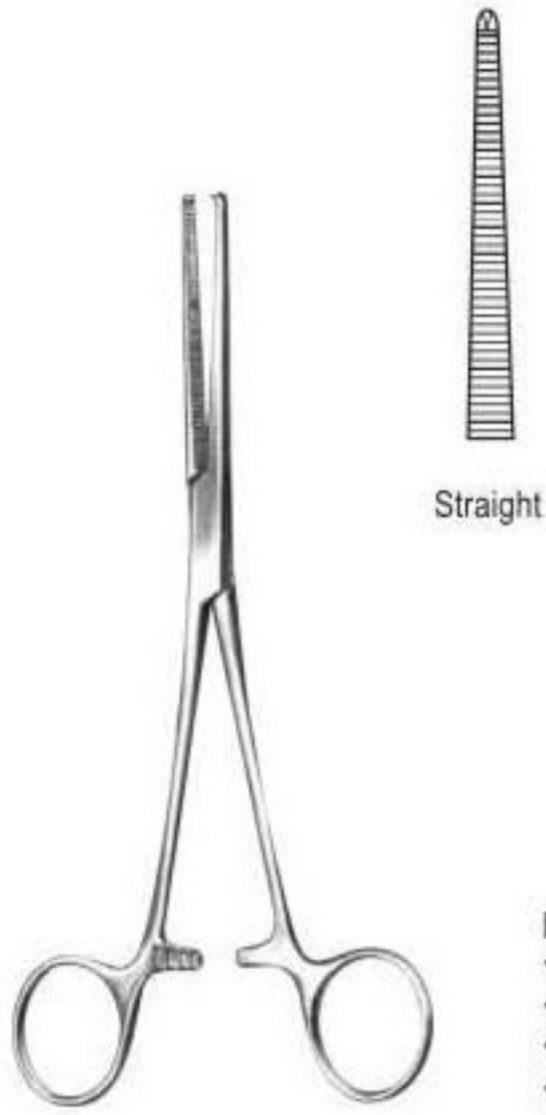

KOCHER
10-1118 - 10-1120
10-1118 13 cm
10-1119 14 cm
10-1120 16 cm

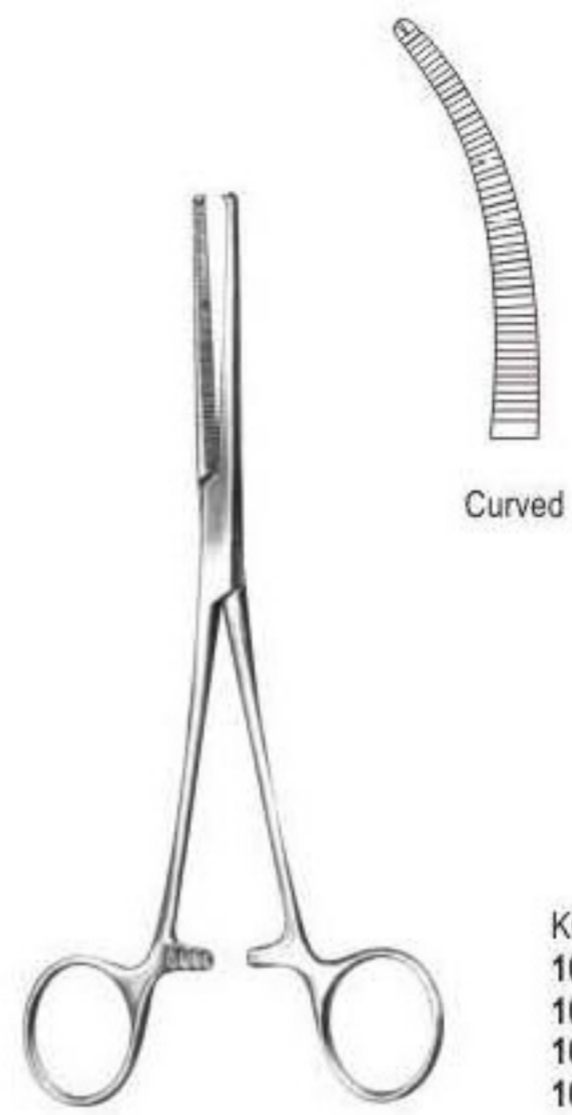

KOCHER
10-1121 - 10-1123
10-1121 13 cm
10-1122 14 cm
10-1123 16 cm

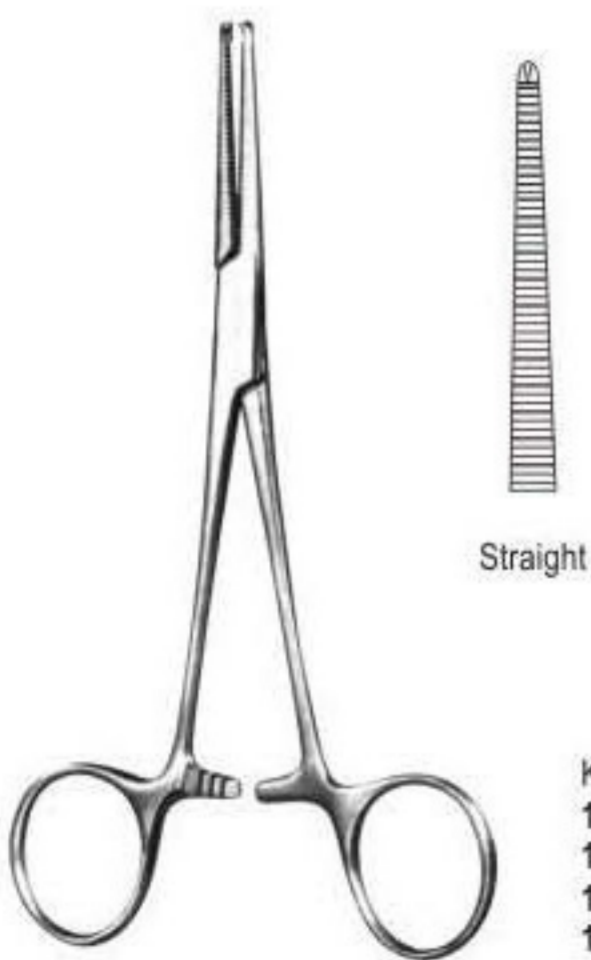

KOCHER-Delicate
10-1124 - 10-1126
10-1124 14.5 cm
10-1125 16 cm
10-1126 18 cm

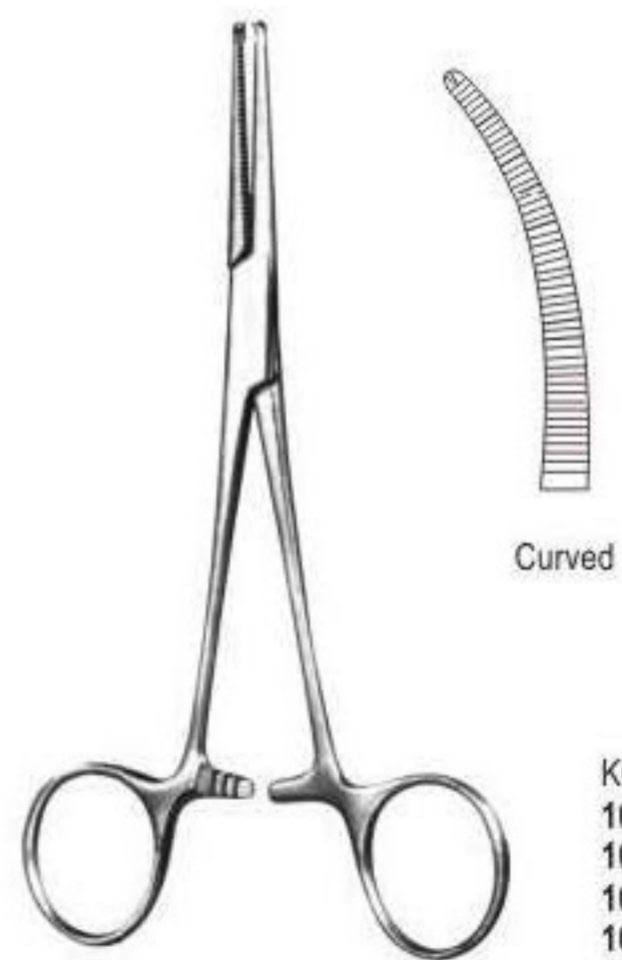

KOCHER-Delicate
10-1127 - 10-1129
10-1127 14.5 cm
10-1128 16 cm
10-1129 18 cm

Haemostatic Forceps



Straight

- PEAN (ROCHESTER)**
10-1130 - 10-1137
 10-1130 14 cm
 10-1131 16 cm
 10-1132 18 cm
 10-1133 20 cm
 10-1134 22 cm
 10-1135 24 cm
 10-1136 26 cm
 10-1137 30 cm



Curved

- PEAN (ROCHESTER)**
10-1138 - 10-1145
 10-1138 14 cm
 10-1139 16 cm
 10-1140 18 cm
 10-1141 20 cm
 10-1142 22 cm
 10-1143 24 cm
 10-1144 26 cm
 10-1145 30 cm

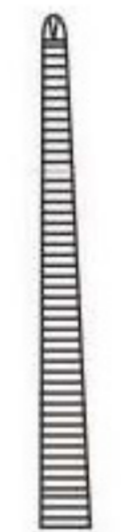
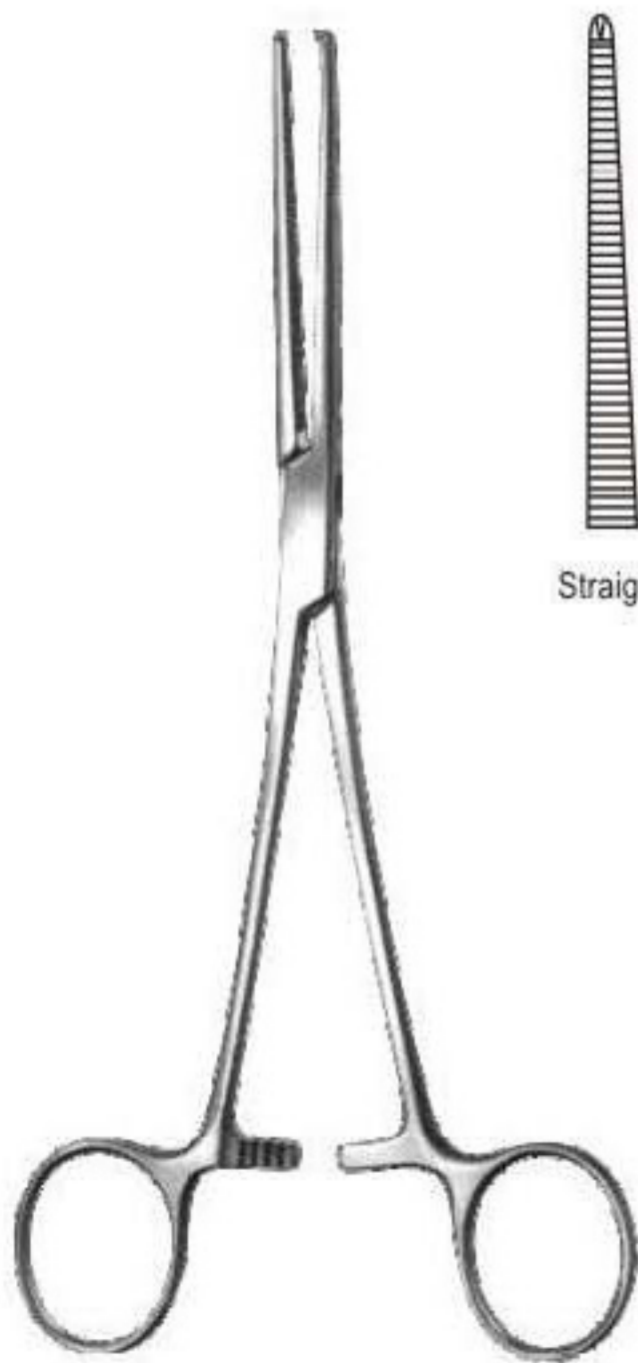

Straight

- KOCHER (OCHSNER)**
10-1146 - 10-1153
 10-1146 14 cm
 10-1147 16 cm
 10-1148 18 cm
 10-1149 20 cm
 10-1150 22 cm
 10-1151 24 cm
 10-1152 26 cm
 10-1153 31 cm



Curved

- KOCHER (OCHSNER)**
10-1154 - 10-1161
 10-1154 14 cm
 10-1155 16 cm
 10-1156 18 cm
 10-1157 20 cm
 10-1158 22 cm
 10-1159 24 cm
 10-1160 26 cm
 10-1161 31 cm

Delicate Haemostatic Forceps



1/4
Straight

1/2

ADSON
10-1162
18.5 cm



1/4
Curved

1/2

ADSON
10-1163
19 cm



10-1164
14.5 cm



10-1165
18 cm

ADSON (BABY)
10-1164 - 10-1165

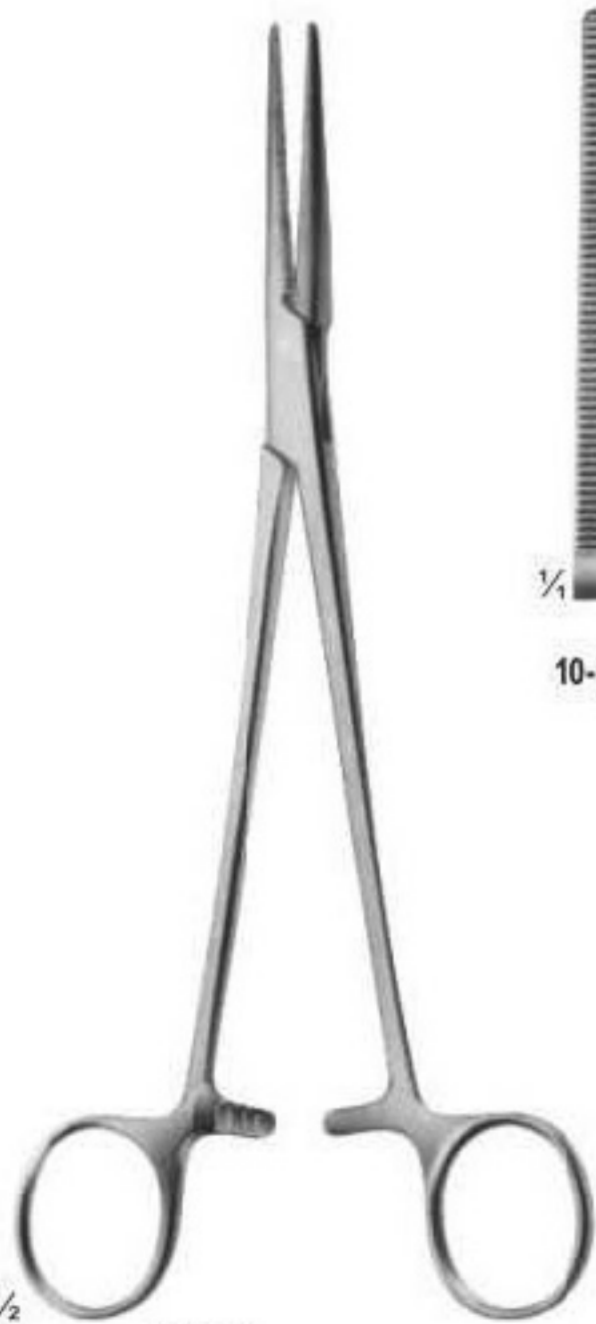

1/4
10-1166



1/4
10-1167



1/4
10-1163



1/4
10-1169



1/4
10-1170

1/2

HEISS
10-1166 - 10-1170
20 cm



1/4

1/2

HEISS
10-1171
19.5 cm

Haemostatic Forceps



OVERHOLT-MARTIN
10-1172 - 10-1176



Fig. 1
10-1172
18.5 cm



Fig. 2
10-1173
20.5 cm

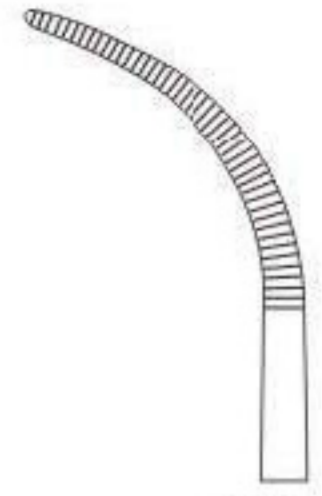

Fig. 3
10-1174
21 cm

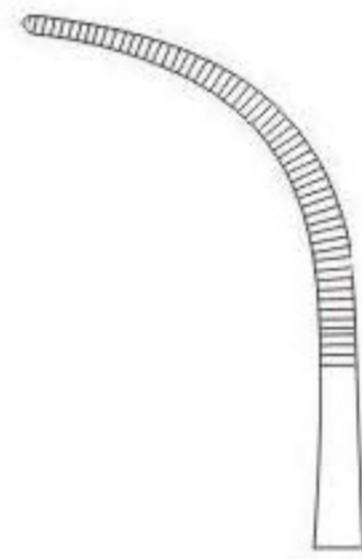

Fig. 4
10-1175
21.5 cm

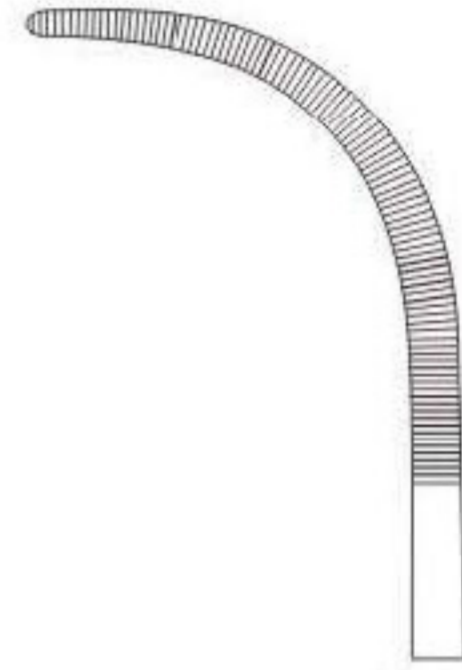

Fig. 5
10-1176
24.5 cm



MIXTER-BABY
10-1177
18.5 cm



OVERHOLT-MIXTER
10-1178
18.5 cm



OVERHOLT-MIXTER
10-1179
20.5 cm

Haemostatic Forceps



$\frac{1}{2}$
MIXTER-O'SHAUGHNESSY
10-1180
19 cm



MIXTER
10-1181 - 10-1182



10-1181
16 cm

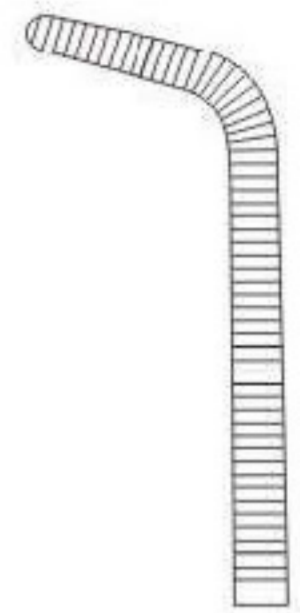

10-1182
17.5 cm



MIXTER
10-1183
22.5 cm



MIXTER
10-1184
23 cm

Haemostatic Forceps



MIXTER
10-1185 - 10-1187

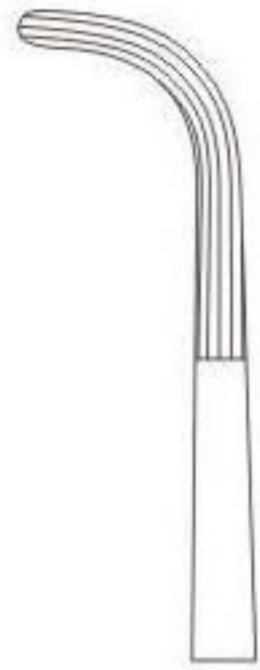

10-1185
22.5 cm

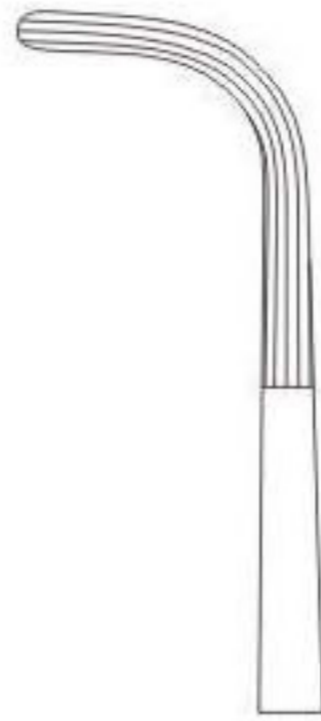

10-1186
26 cm

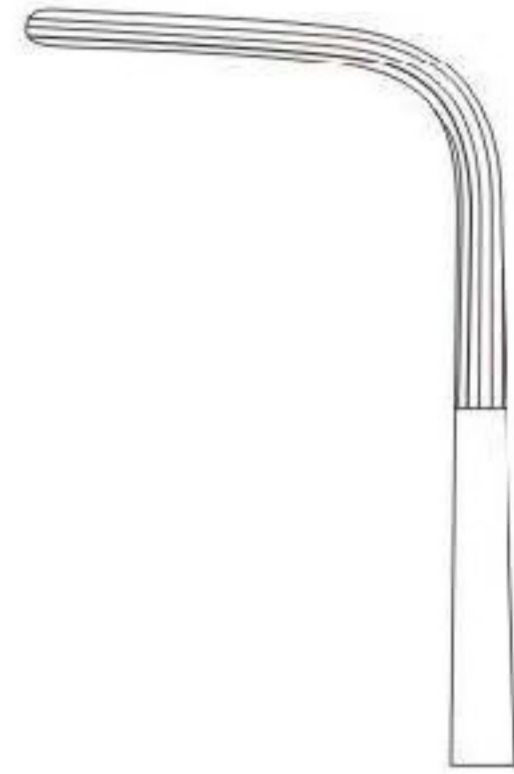

10-1187
28 cm



1/2

MIXTER
10-1188 - 10-1189
10-1188 22 cm
10-1189 25 cm



1/4



MCQUIGG-MIXTER
10-1190
23.5 cm

Haemostatic Forceps



MINI-GEMINI
10-1191 - 10-1194



10-1191
18 cm



10-1192
23 cm



10-1193
25 cm



10-1194
28 cm



OVERHOLT-MINI
10-1195
20 cm



GEMINI
10-1096 - 10-1202



10-1196
13 cm



10-1197
16 cm



10-1198
18 cm



10-1199
21 cm



10-1200
23 cm



10-1201
25 cm



10-1202
28 cm

Dissecting- And Ligature Forceps

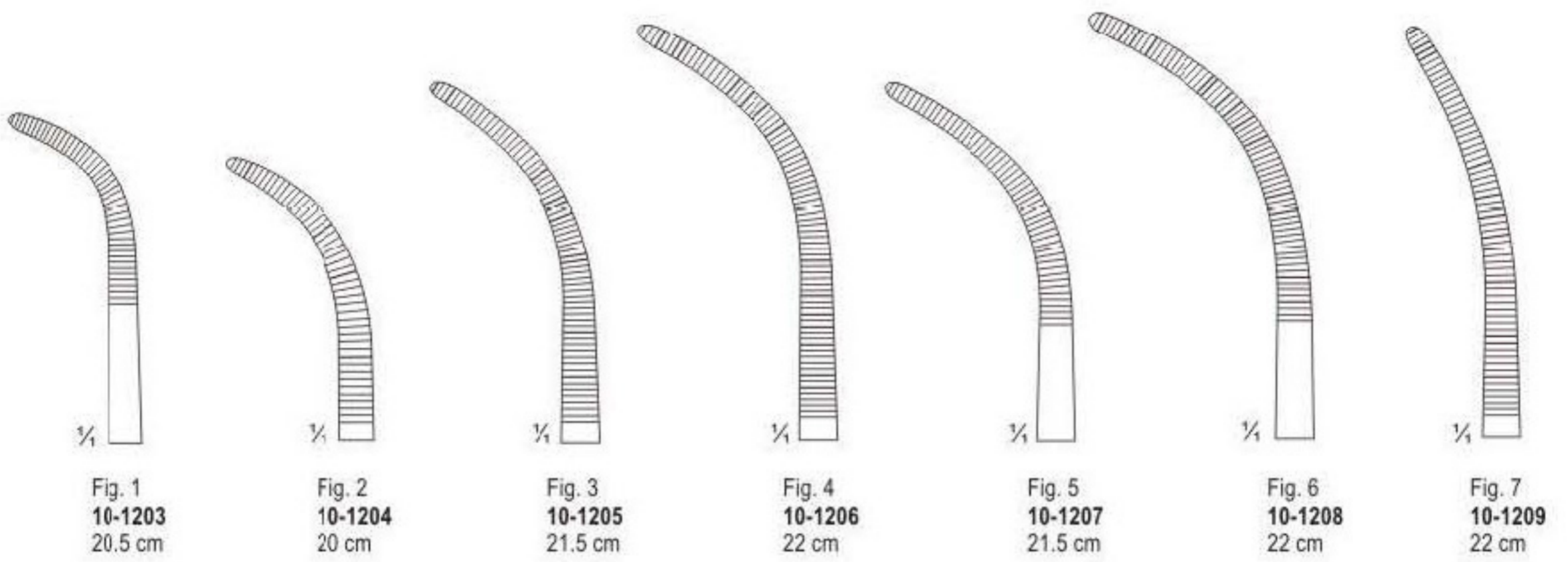

OVERHOLT-GEISSENDOERFER
10-1203 - 10-1216

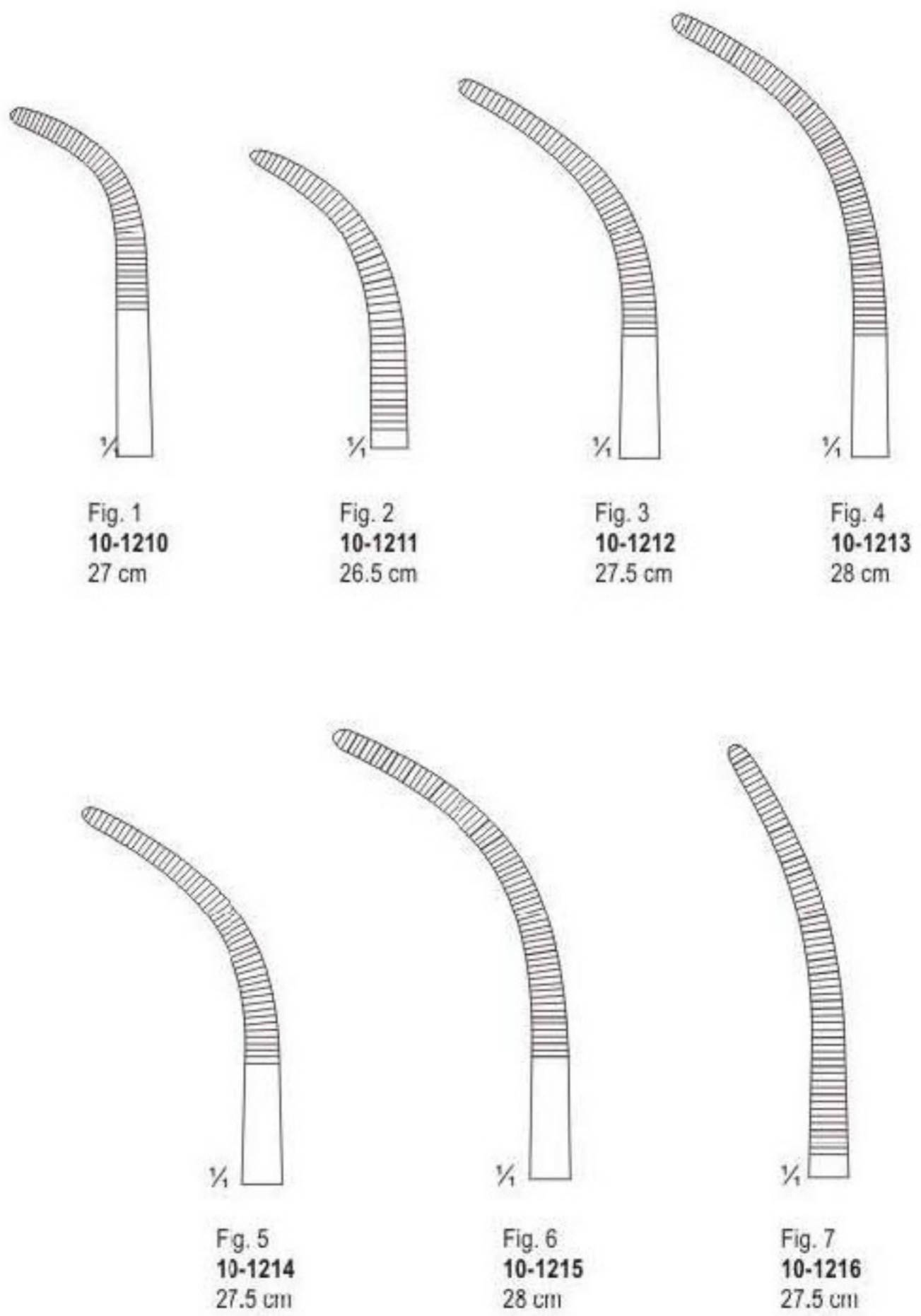

Haemostatic Forceps



OVERHOLT
10-1217 - 10-1219

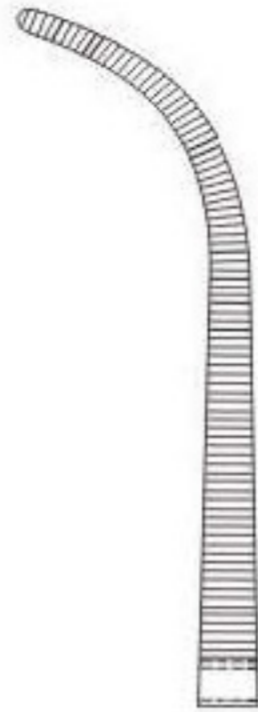

10-1217
29.5 cm

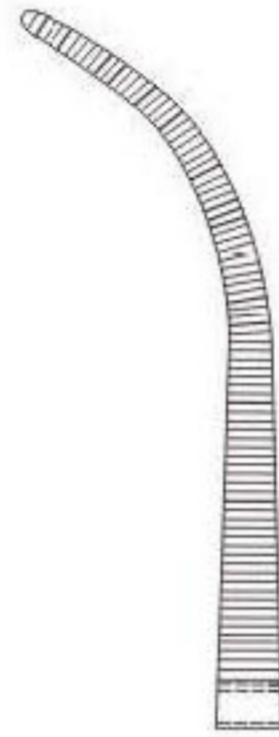

10-1218
29.5 cm

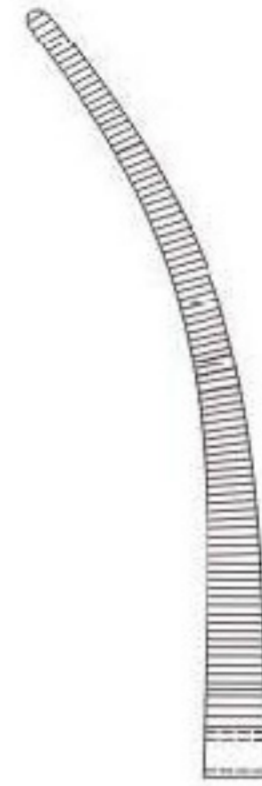

10-1219
30 cm



OVERHOLT-DELICATE
10-1220 - 10-1224

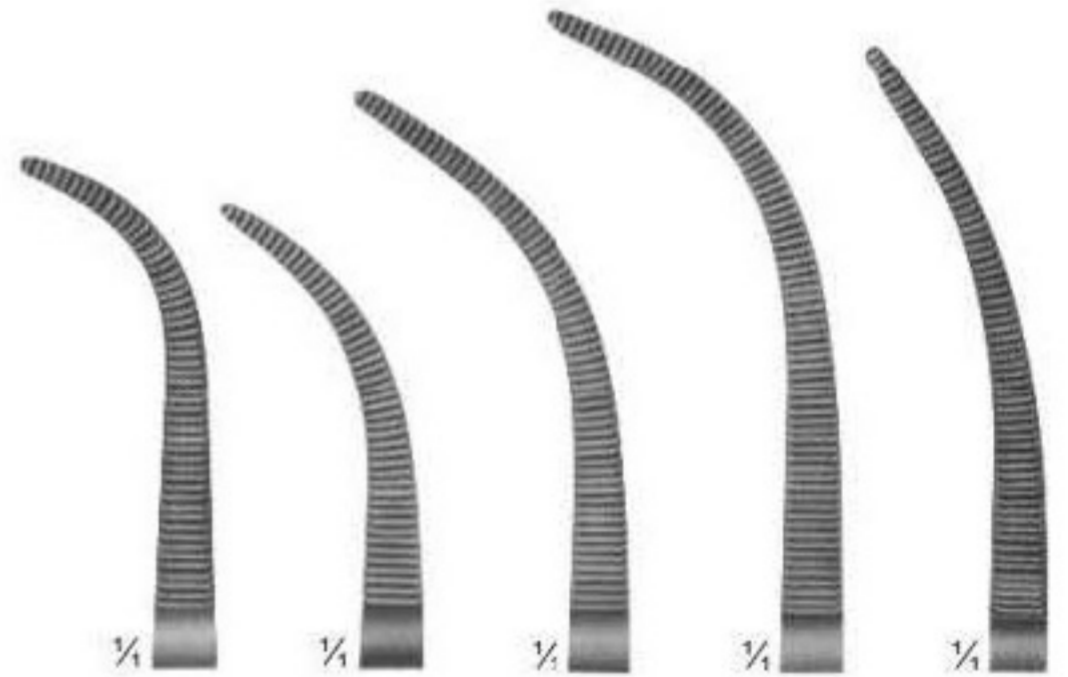

Fig. 0
10-1220
21.5 cm

Fig. 1
10-1221
22 cm

Fig. 2
10-1222
22.5 cm

Fig. 3
10-1223
23 cm

Fig. 6
10-1224
22.5 cm

Haemostatic Forceps, Special Pattern, Tonsil Forceps



CRAFOORD
10-1225 - 10-1226



$\frac{1}{4}$
10-1225
18 cm



$\frac{1}{4}$
10-1226
24 cm



CRAFOORD-SELLORS
10-1227 - 10-1229
24 cm



$\frac{1}{4}$
10-1227

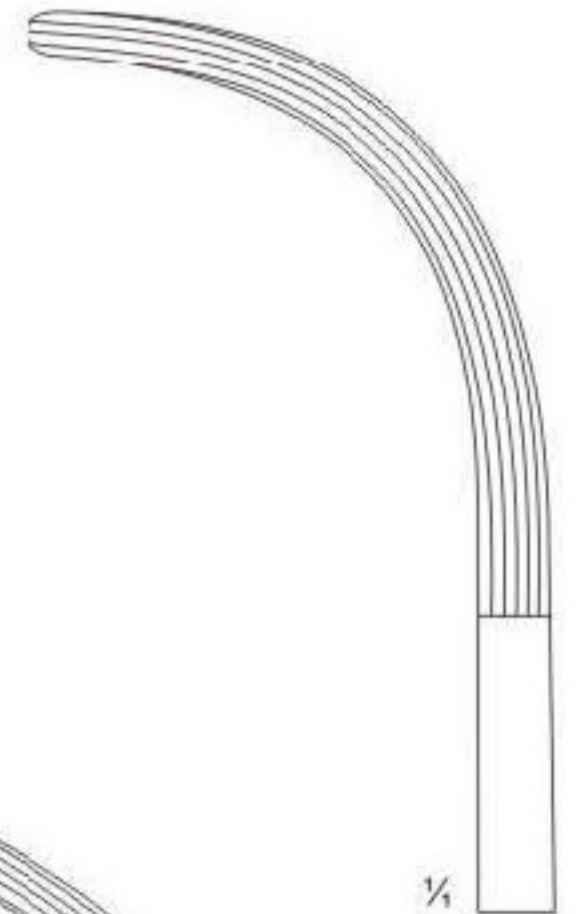

$\frac{1}{4}$
10-1228

$\frac{1}{4}$
10-1229

Haemostatic Forceps, Special Pattern, Tonsil Forceps

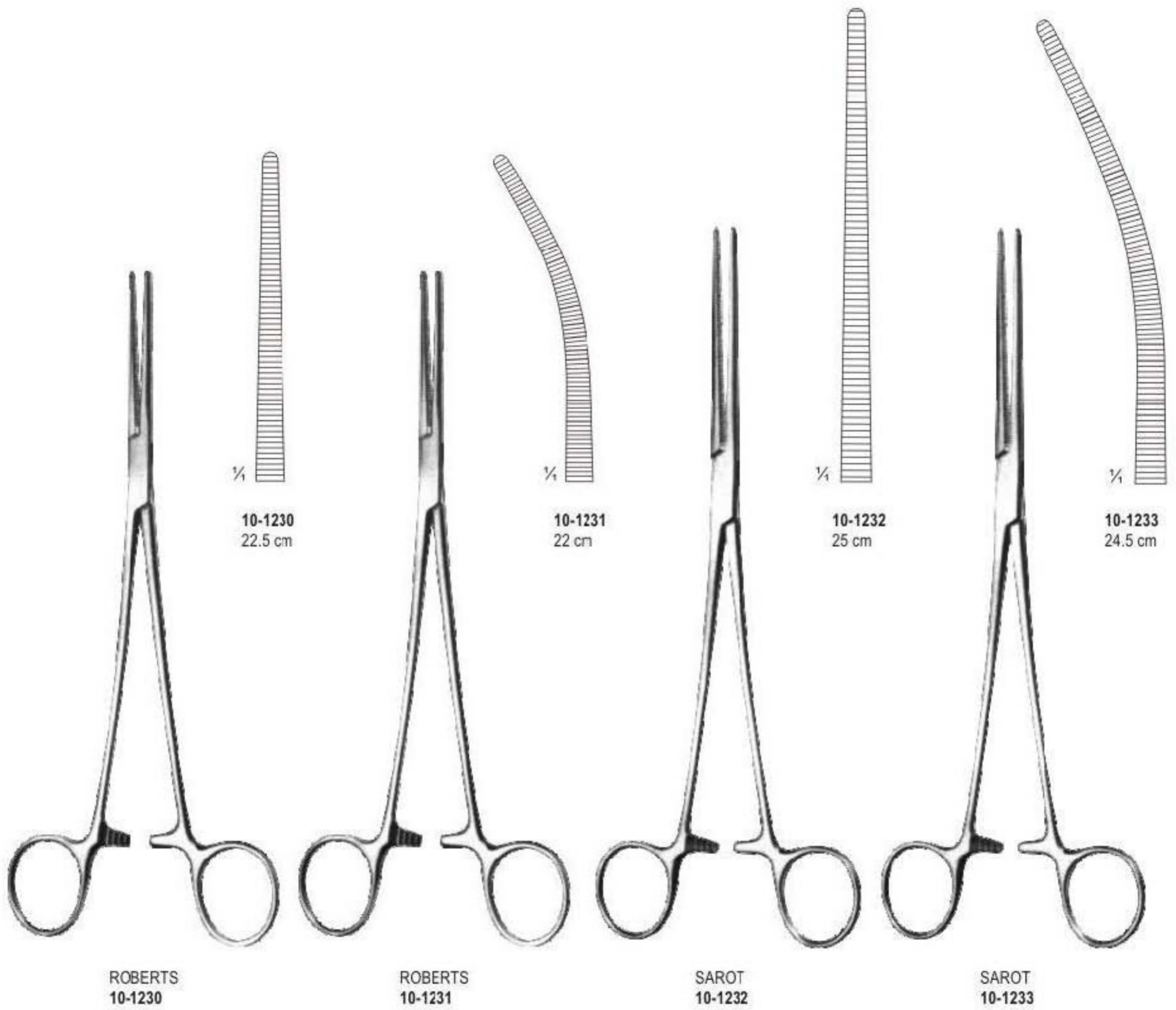

Dissecting- And Ligature Forceps



RUMEL
10-1234 - 10-1238
24 cm



1/4

10-1234



1/4

10-1235



1/4

10-1236



1/4

10-1237



1/4

10-1238



ZENKER
10-1239 - 10-1240
10-1239 30 cm
10-1240 29 cm



1/4



1/4

LAWRENCE
10-1241
27 cm



NEGUS
10-1242 - 10-1243
19 cm



1/4

10-1242



1/4

10-1243

Dissecting- And Ligature Forceps



MEEKER
10-1244
28 cm



KELLY
10-1245 - 10-1253



Fig. 1
10-1245
19 cm

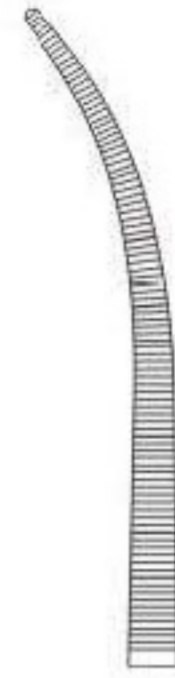

Fig. 1
10-1246
22.5 cm



Fig. 1
10-1247
24 cm



Fig. 2
10-1248
19 cm

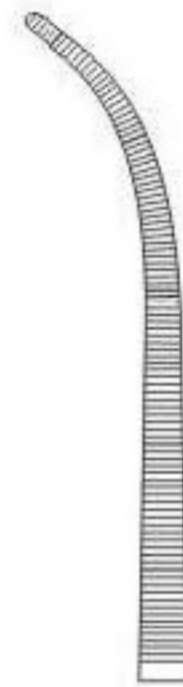

Fig. 2
10-1249
22 cm

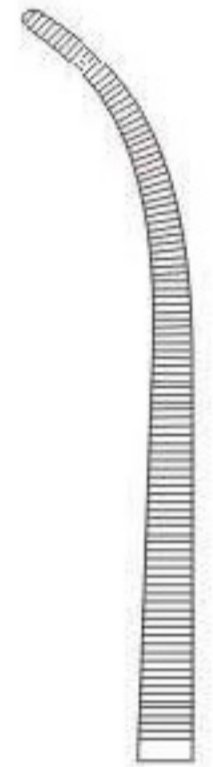

Fig. 2
10-1250
23.5 cm



Fig. 3
10-1251
18.5 cm

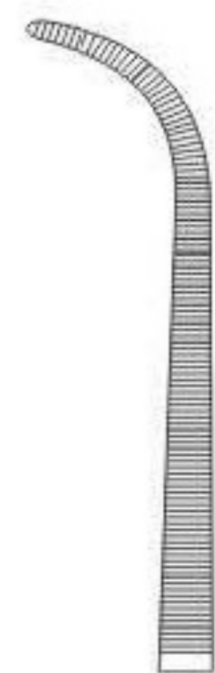

Fig. 3
10-1252
21.5 cm

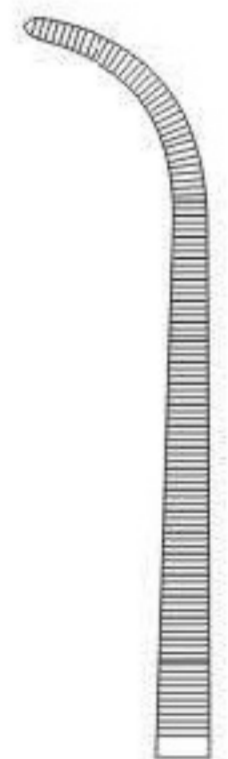

Fig. 3
10-1253
23.5 cm

Dissecting- And Ligature Forceps



FINOCHIETTO
10-1254
24.5 cm



FINOCHIETTO
10-1255
24.5 cm



LAHEY (SWEET)
10-1256 - 10-1257
10-1256 19 cm
10-1257 23 cm



DESJARDINS
10-1258
21 cm



LOWER
10-1259
18 cm



NISSEN
10-1260
18 cm

Haemostatic Forceps, Special Pattern, Tonsil Forceps

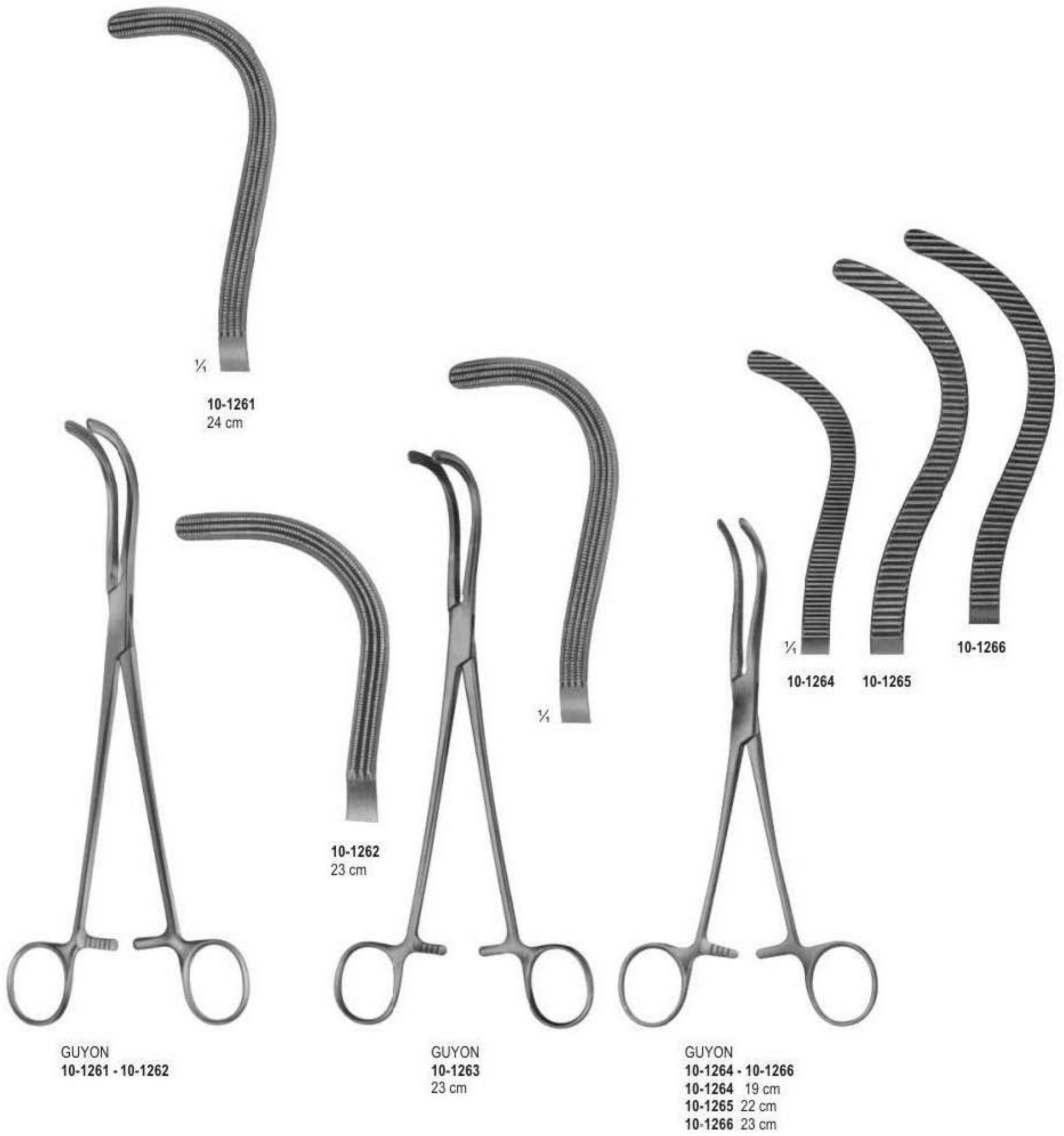

Haemostatic Forceps, Special Pattern, Tonsil Forceps



GRAY
10-1267 - 10-1268
22 cm



¼
10-1267



¼
10-1268



GRAY
10-1269 - 10-1270
22 cm



¼
10-1269



¼
10-1270



NEGUS
10-1271 - 10-1272
19 cm



¼
10-1271



¼
10-1272



MOYNIHAN
10-1273 - 10-1274



¼
10-1273
23 cm



¼
10-1274
24 cm

Haemostatic Forceps, Special Pattern, Tonsil Forceps



YASARGIL
10-1275 - 10-1276
19.5 cm



STILLE
10-1277
22 cm

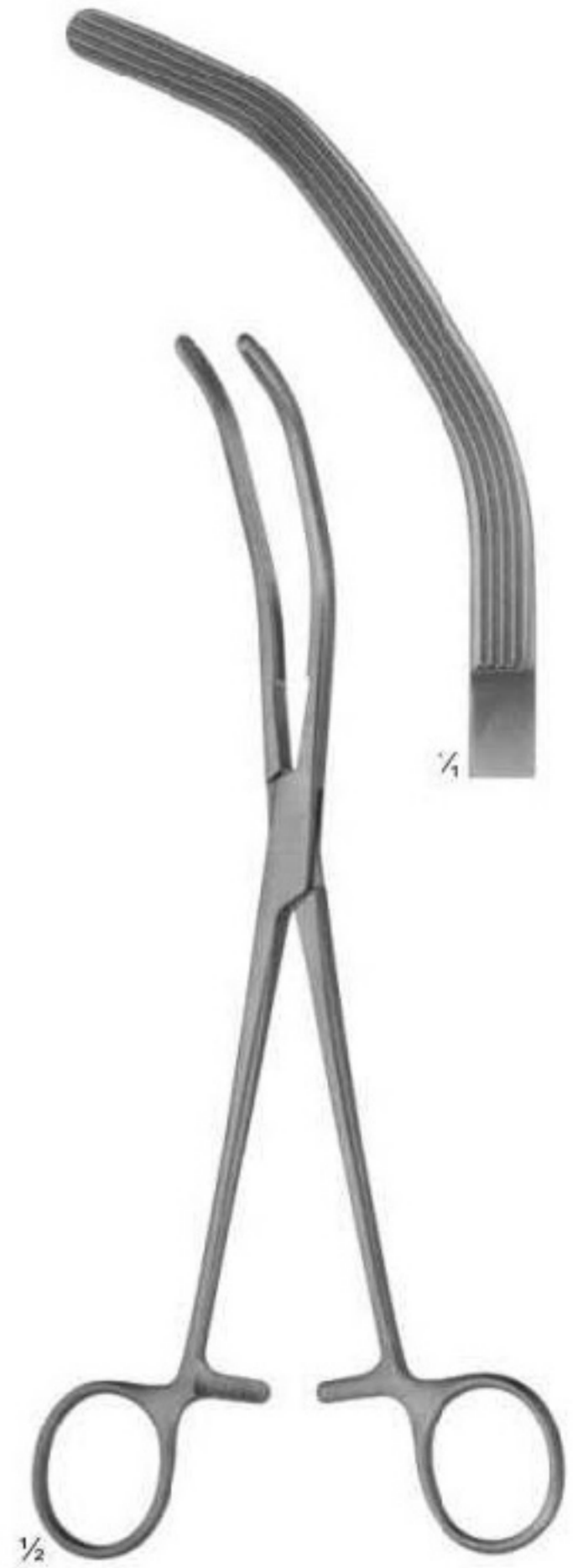

HERRICK
10-1278
22.5 cm

Towel Clamps



ROEIN
with holders for tubing
up to 13 mm
10-1279
13.5 cm



10-1280
with clip for tubing
up to 15 mm
11 cm

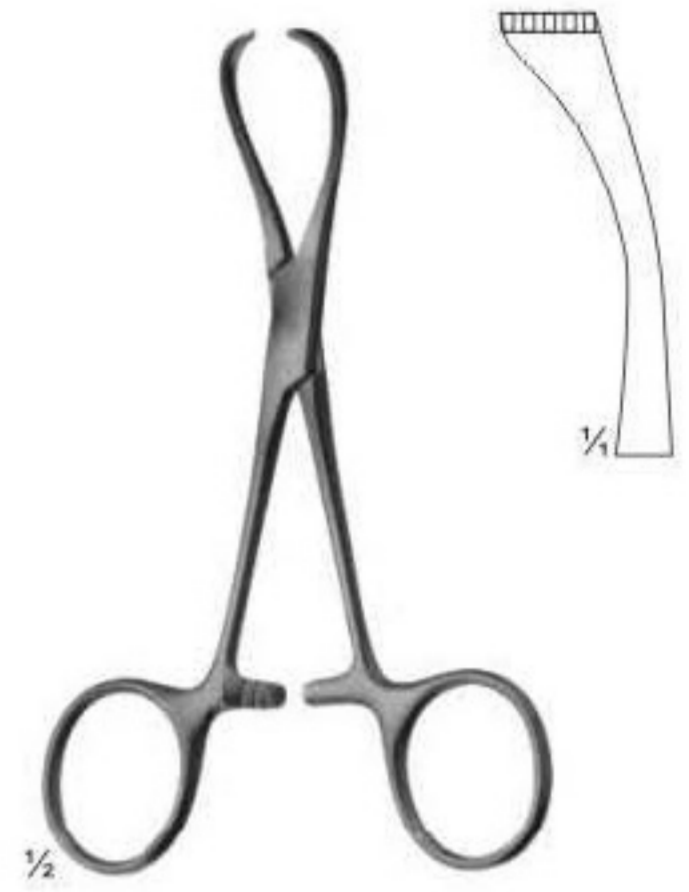

LORNA
non perforating
10-1281
13 cm

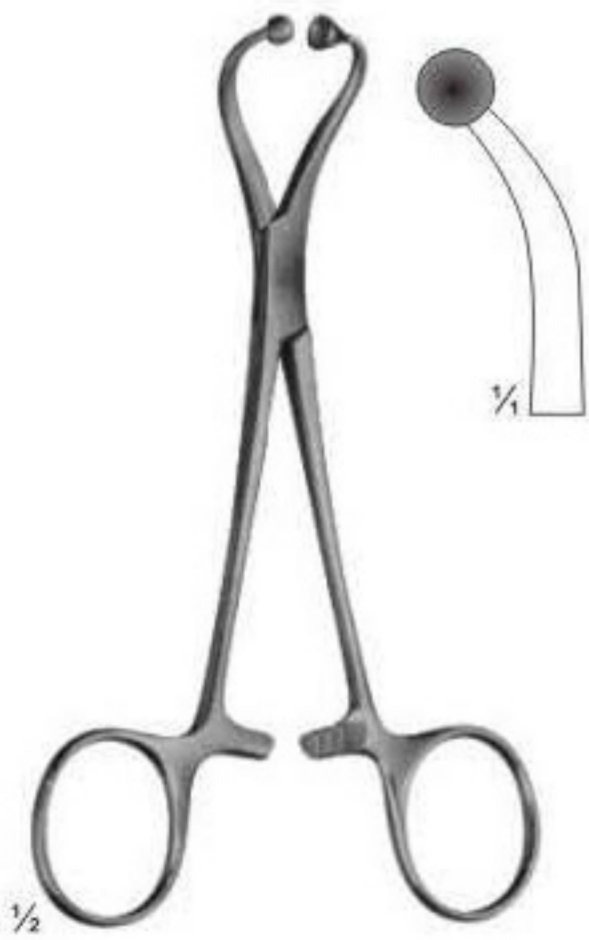

for paper cloths
10-1282
14 cm



BUNT
10-1283
10.5 cm



MAYO
10-1284
14 cm

Towel Clamps

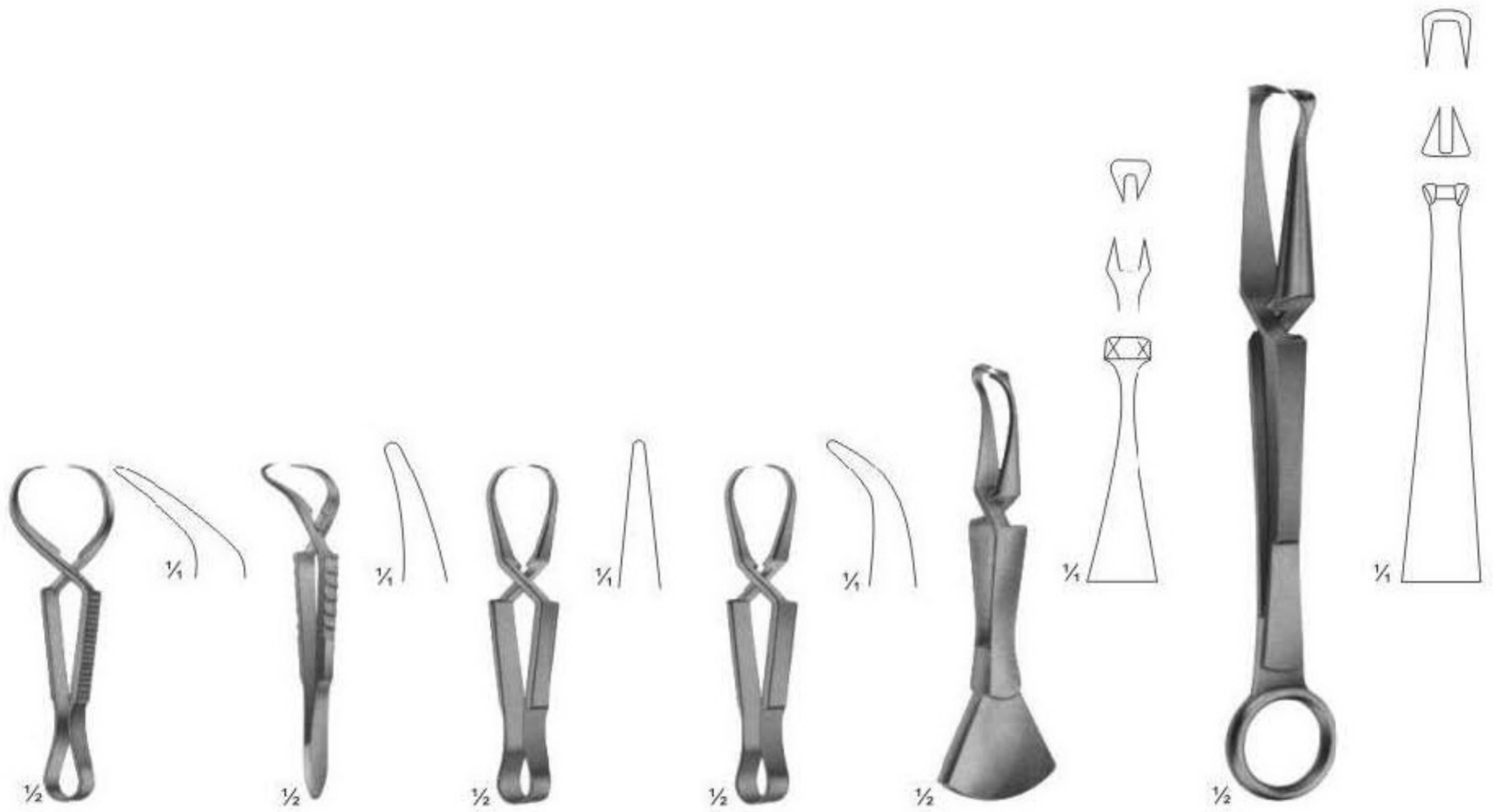

**JONES
10-1285
8.5 cm**

**ENGL. MOD
10-1286
8.5 cm**

**SCHAEDEL
10-1287
8.5 cm**

**SCHAEDEL
10-1288
8.5 cm**

**DOYEN
10-1289
11 cm**

**DOYEN
10-1290
18 cm**

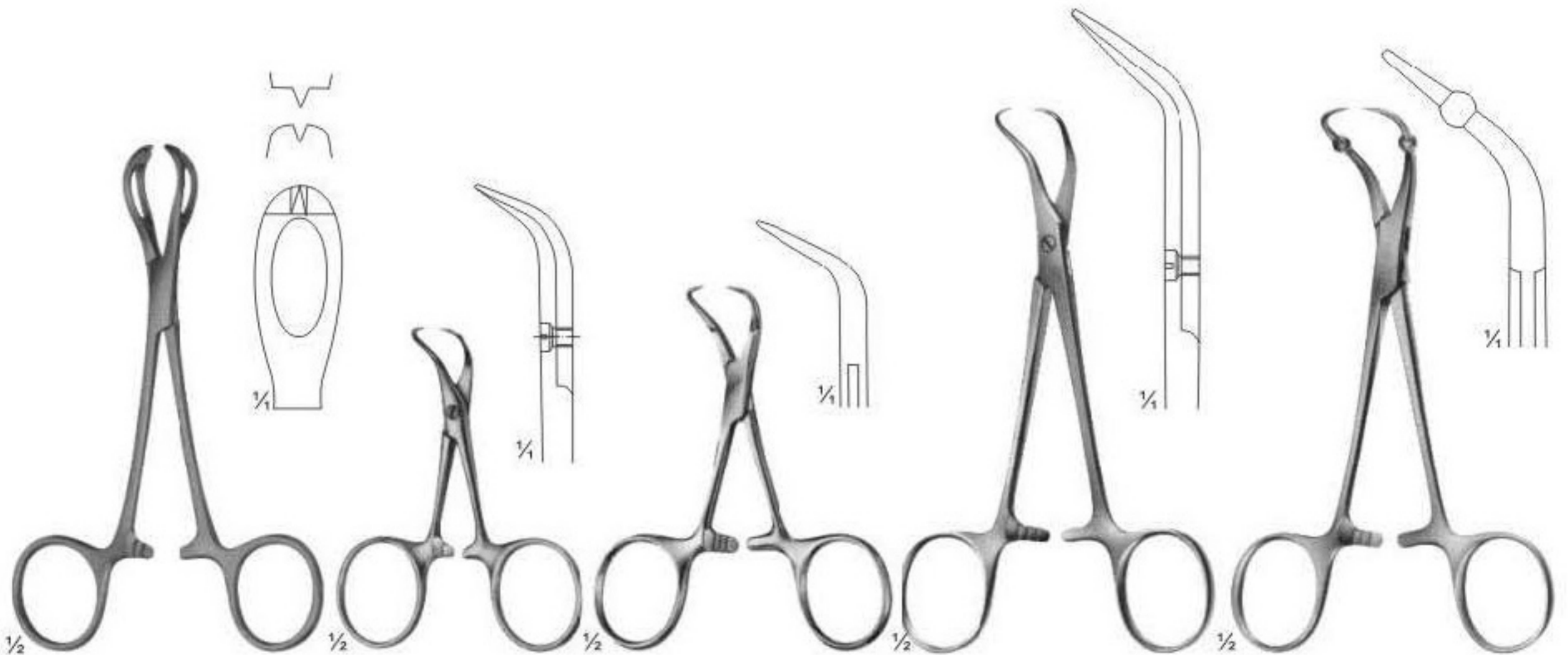

**LANE
10-1291 - 10-1293
10-1291 13 cm
10-1292 15.5 cm
10-1293 19.5 cm**

**BACKHAUS
10-1294 - 10-1295
10-1294 8 cm
10-1295 10.5 cm**

**BACKHAUS
10-1296 - 10-1298
10-1296 9 cm
10-1297 11 cm
10-1298 13.5 cm**

**BACKHAUS-KOCHER
10-1299
13.5 cm**

**ROEDER
10-1300
13.5 cm**

Tendon Seizing Forceps



10-1301



10-1302

HERZ
10-1301 - 10-1302
15.5 cm



10-1303



JACKSON
4 x 5 teeth
10-1303
15 cm

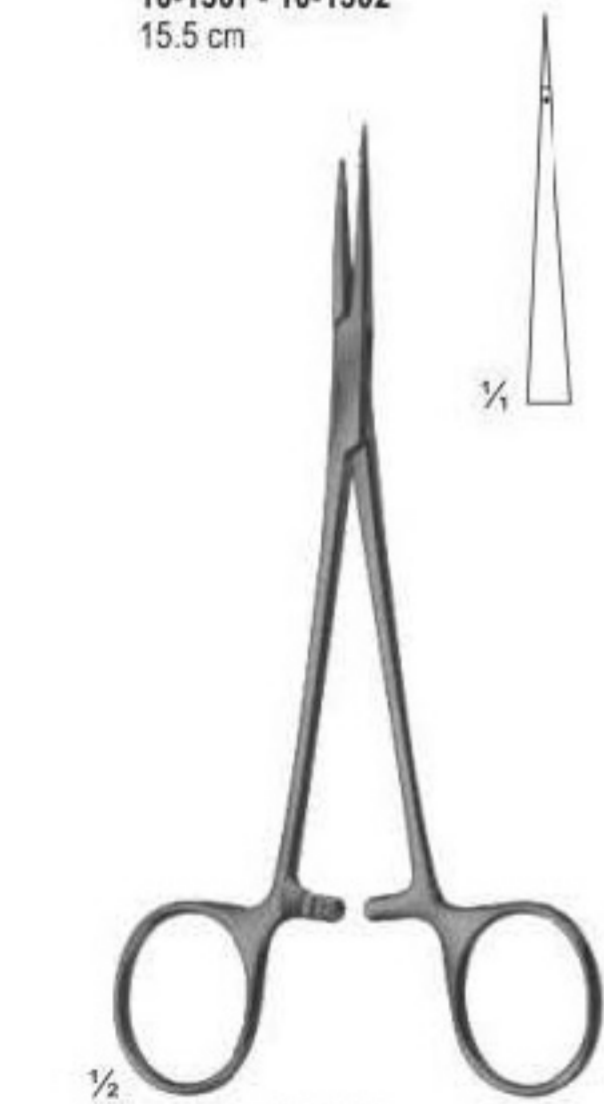

10-1304
15 cm

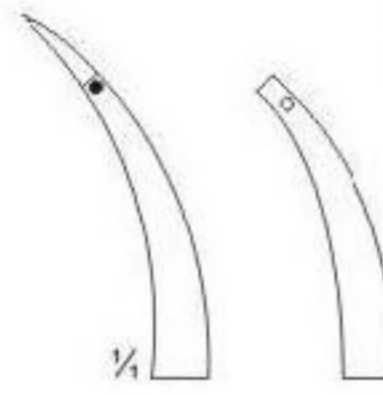

10-1305
15 cm

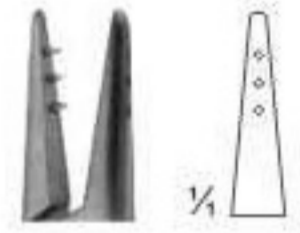

10-1306
12 cm

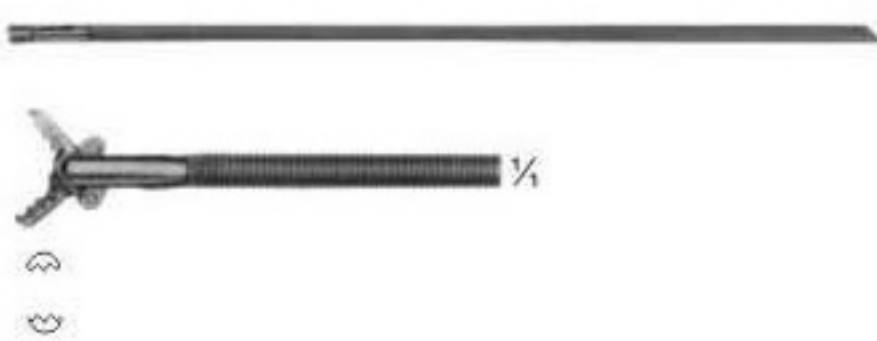

JAGER
Tendon-and cross ligament
passing forceps
flexible shaft
10-1307
27.5 cm

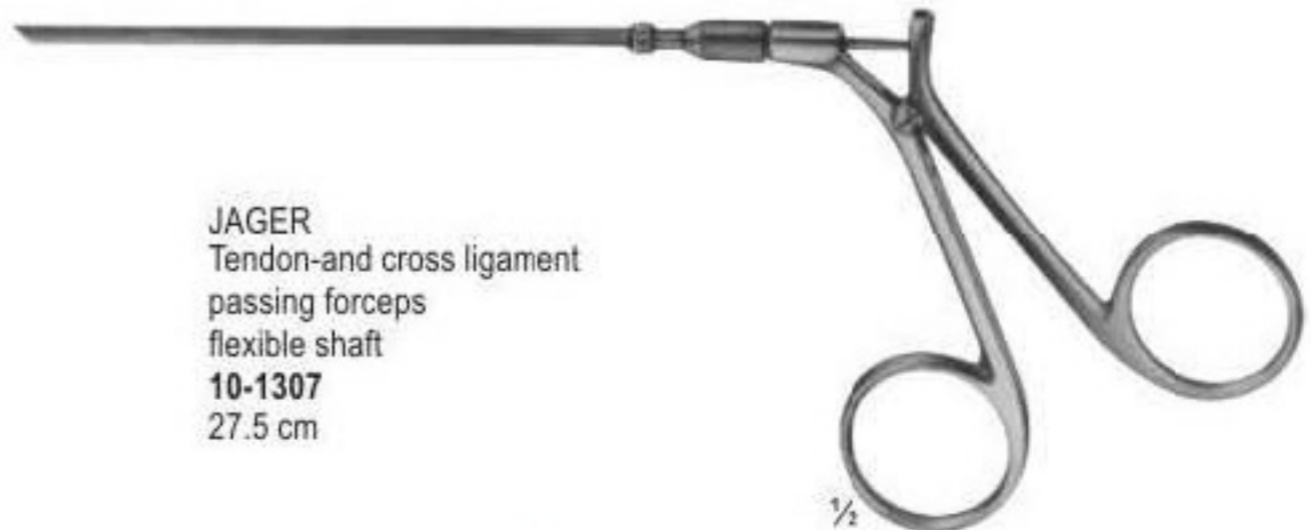

Hysterectomy Forceps, Vaginal Clamps And Compression Forceps



1/2
WERTHEIM
Hysterectomy Forceps
10-1308
25.5 cm



1/2
WERTHEIM
10-1310
22.5 cm

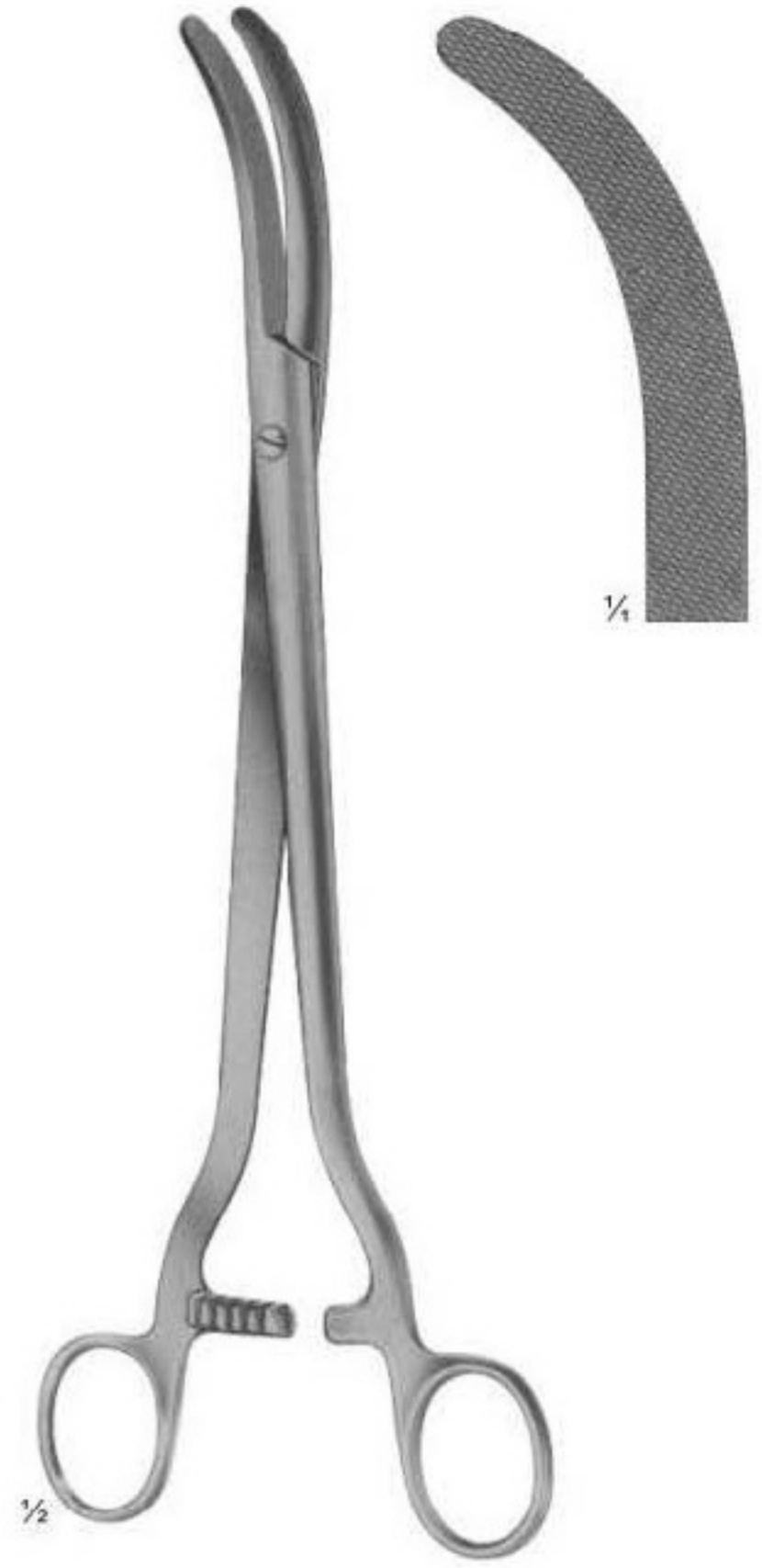

1/2
WERTHEIM
Parametrium Clamp
10-1309
26 cm

Hysterectomy Forceps, Vaginal Clamps And Compression Forceps

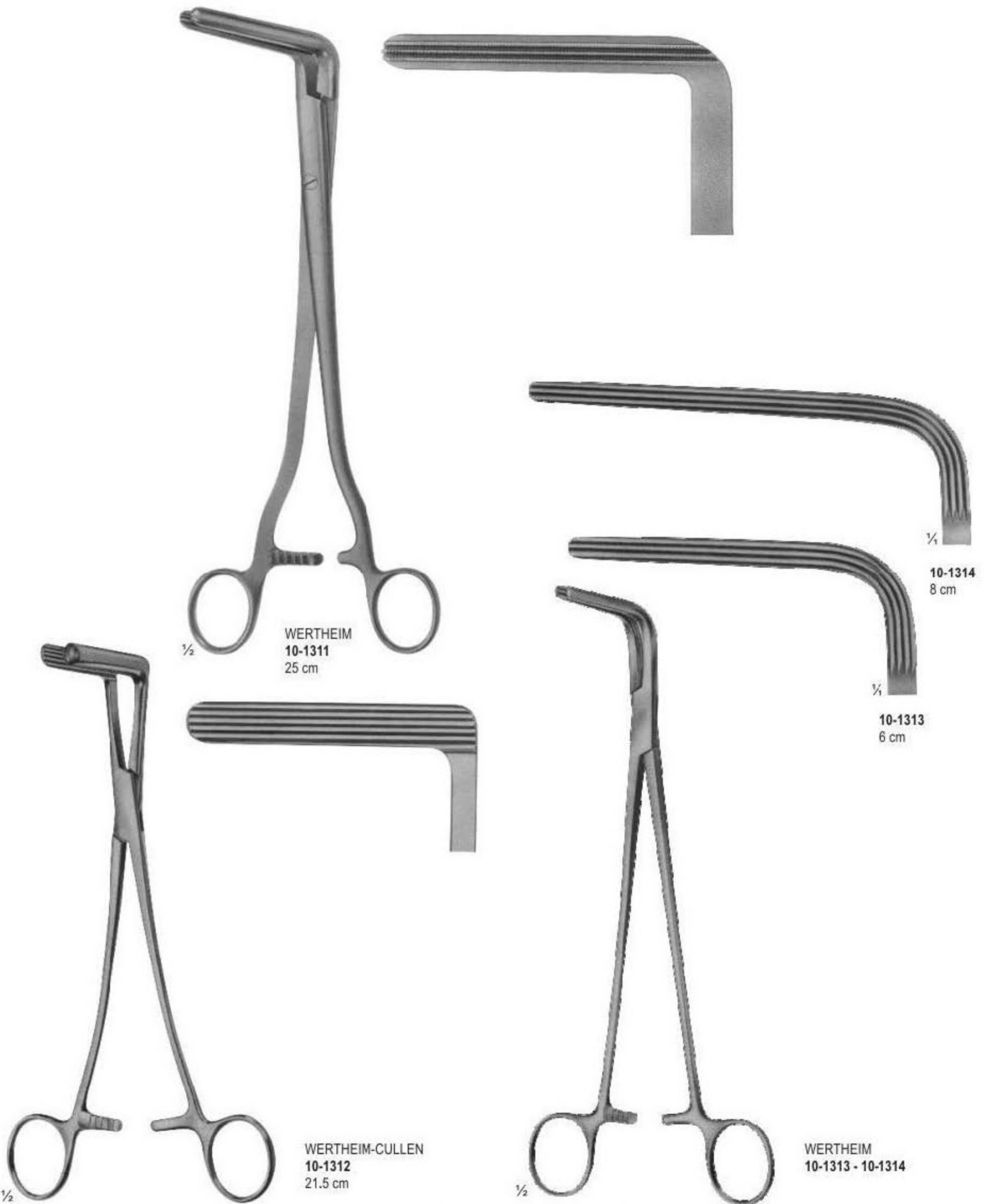

Hysterectomy Forceps



WERTHEIM
10-1315
23.5 cm



WERTHEIM
10-1316
23.5 cm

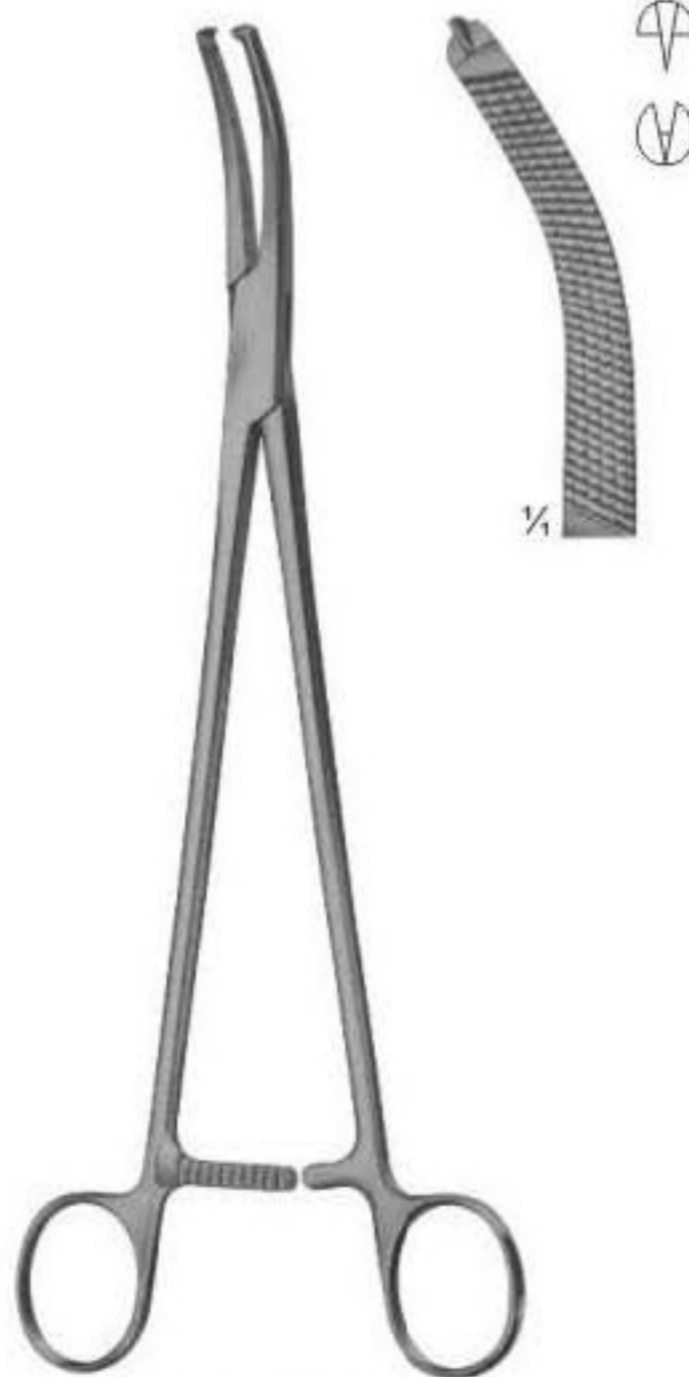

WERTHEIM
10-1317
24.5 cm

Hysterectomy Forceps And Vaginal Clamps



Fig. 1
10-1318
19.5 cm



Fig. 1
10-1319
21.5 cm



Fig. 1
10-1320
24 cm

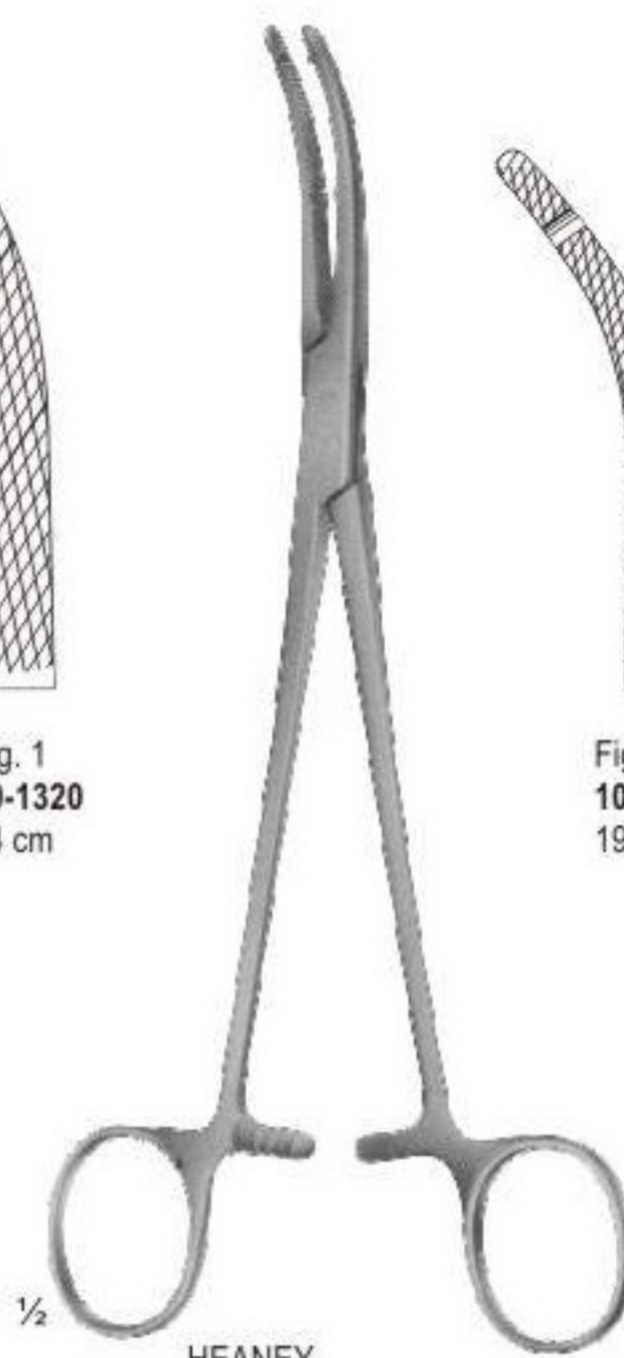

Fig. 2
10-1321
19.5 cm



Fig. 2
10-1322
21.5 cm



Fig. 2
10-1323
24 cm

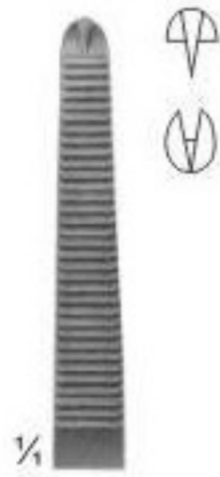

PHANEUF
10-1324 - 10-1325
10-1324 21 cm
10-1325 20 cm



PHANEUF
10-1326 - 10-1327
10-1326 21 cm
10-1327 20 cm

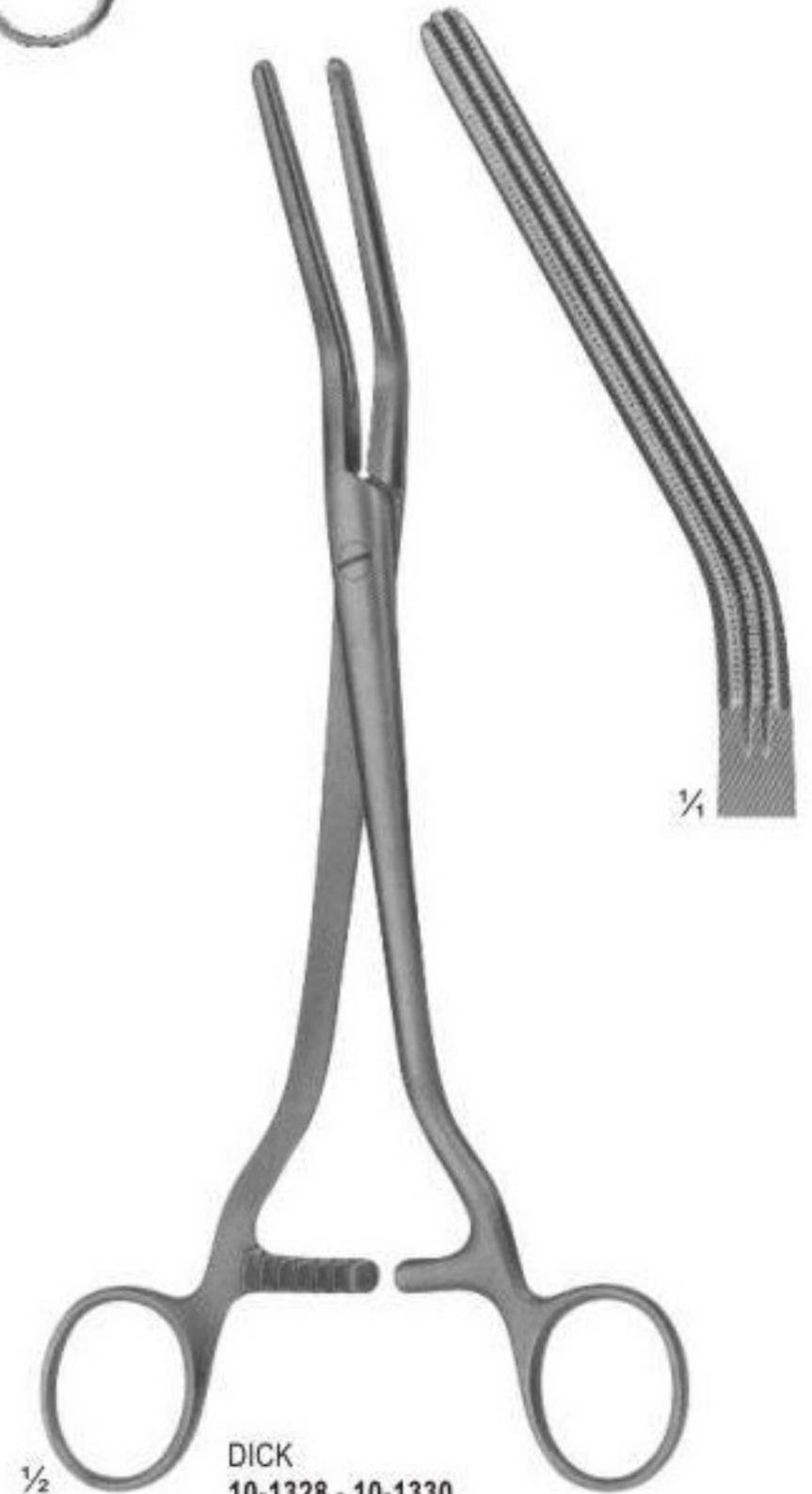

DICK
10-1328 - 10-1330
10-1328 25.5 cm
10-1329 26.5 cm
10-1330 27.5 cm

Hysterectomy Forceps And Vaginal Clamps



ROGERS
10-1331 - 10-1334

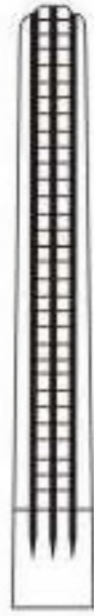

Fig. 1
10-1331
21.5 cm



Fig. 2
10-1332
21 cm



Fig. 3
10-1333
21.5 cm



Fig. 4
10-1334
20.5 cm



ROGERS
10-1335 - 10-1337



Fig. 1
10-1335
25.5 cm

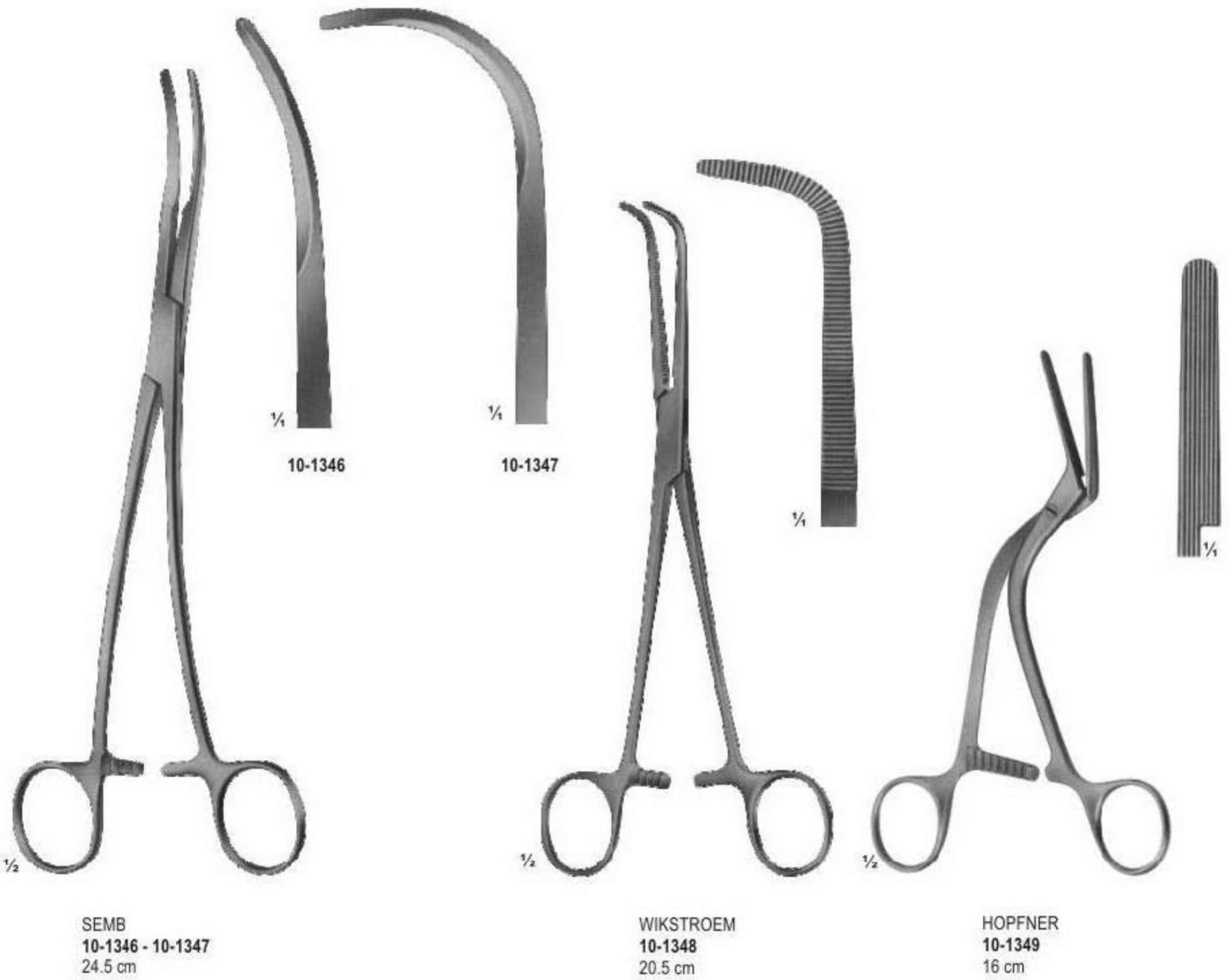

Fig. 2
10-1336
25 cm

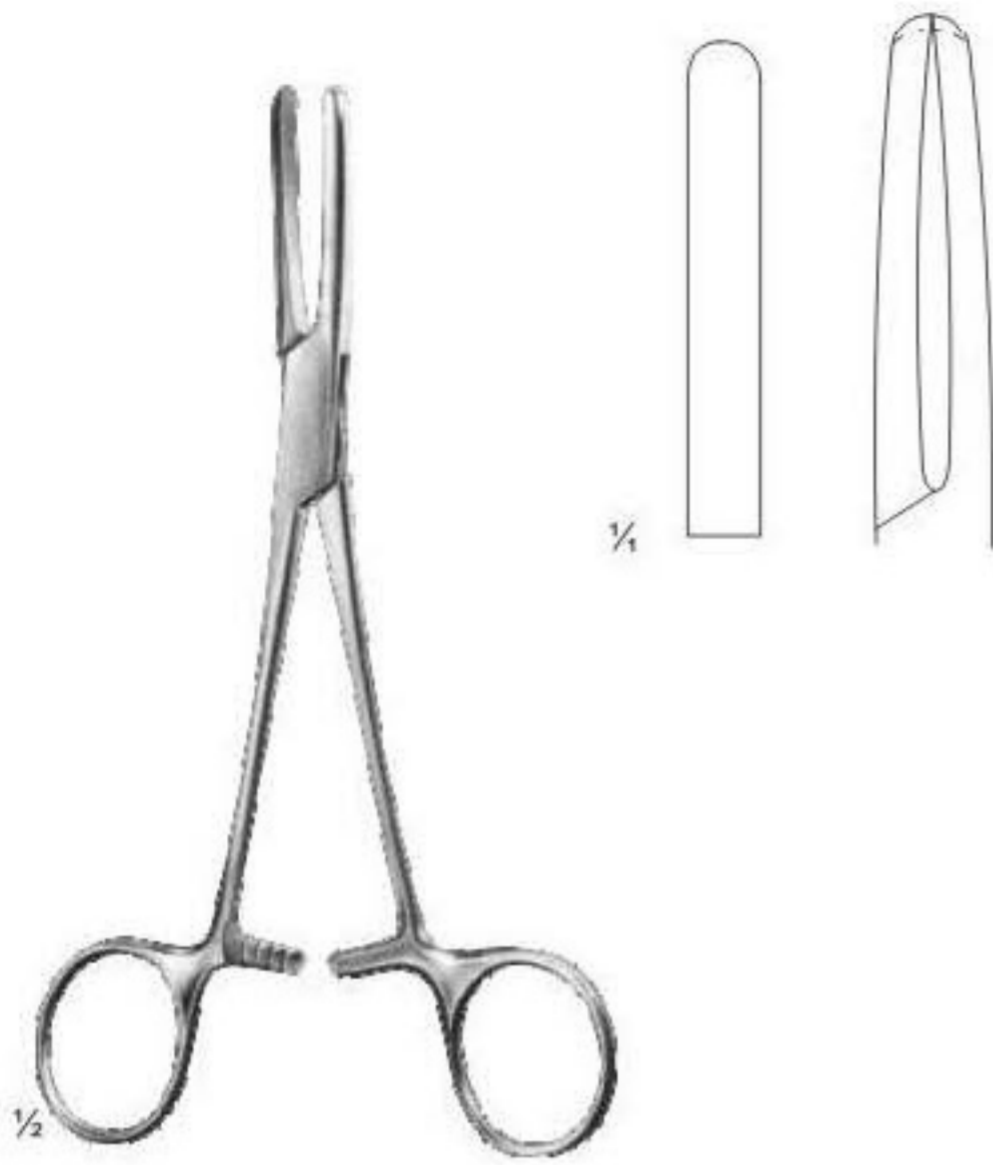

Fig. 3
10-1337
24.5 cm

Hysterectomy Forceps And Vaginal Clamps



Tubing Clamps



10-1350
16.5 cm



10-1351
14 cm

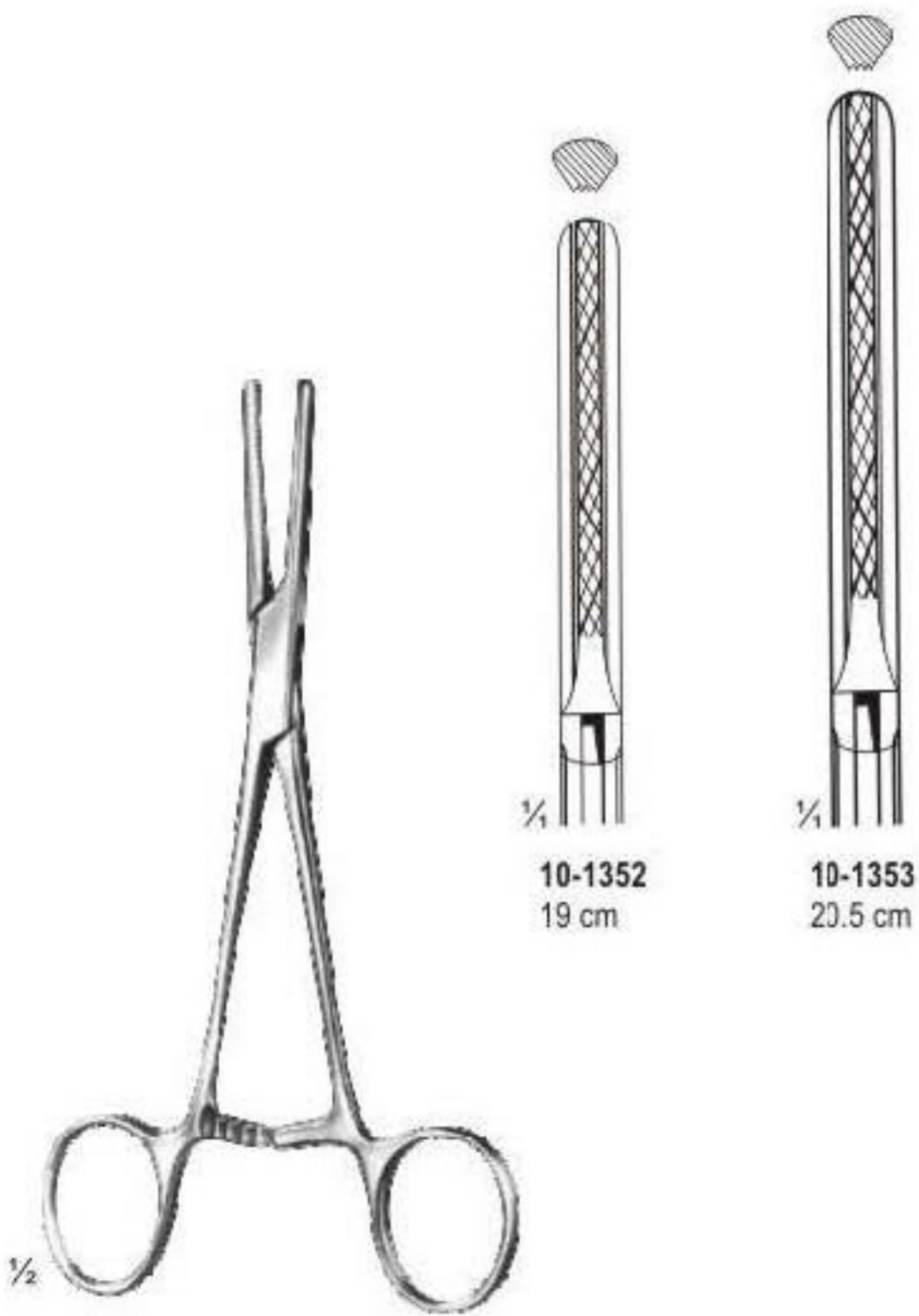

10-1352
19 cm

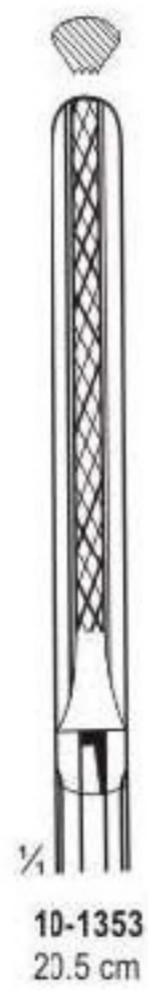

10-1353
20.5 cm

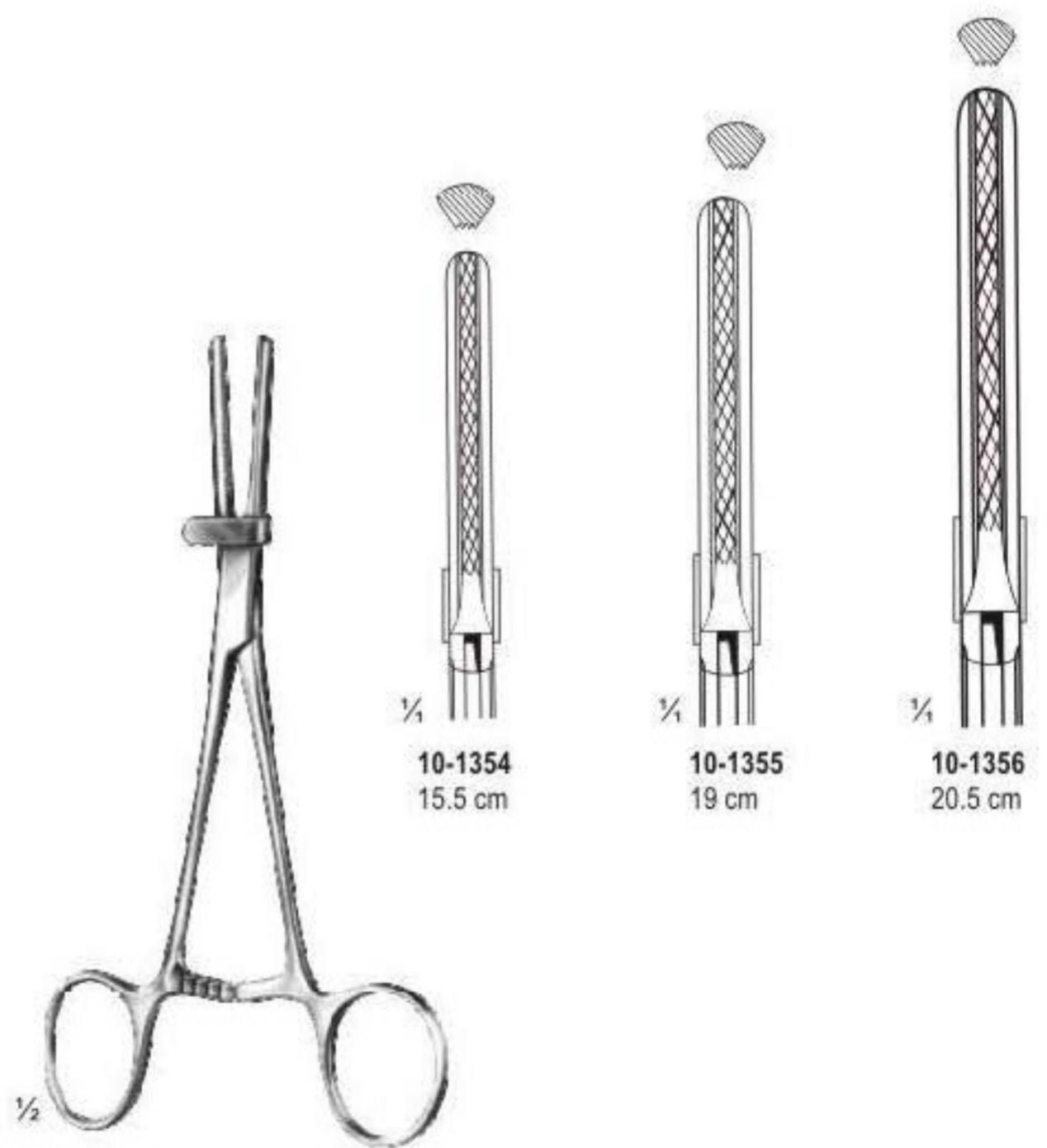

10-1354
15.5 cm

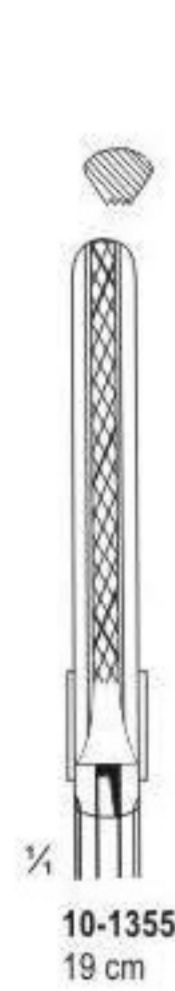

10-1355
19 cm

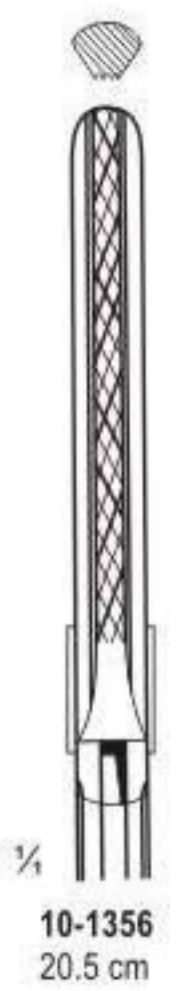

10-1356
20.5 cm

10-1352 - 10-1353

10-1354 - 10-1356

Page 255-261



- Obstetrics-pelvimeters
- Obstetrics-forceps
- Obstetrics-placenta & Ovum Cranioclast, Basiotribe Forceps
- Polypus & Forceps Haemorrhoidal Forceps
- Polypus & Ovum Forceps
- Polypus Scoops, Umbilical Cord Clamps



Obstetrics-pelvimeters



1/3

MARTÍN
11-1001
graduated in centimeters



1/3

COLLIN
11-1002
graduated in centimeters



1/3

COLLIN
11-1003
graduated in centimeters



The additional straight arm can be replaced. The pelvimeter with straight arm is used for localisation of the portio vaginalis uteri and of vaginal metastasis.



1/3

BREISKY
11-1004
graduated in centimeters



1/2

DE LEE
11-1005
graduated in centimeters and inches

for internal measurements between symphysis and promontory

Obstetrics-forceps



1/3
SIMPSON-BRAUN
11-1006
30 cm



SIMPSON-BRAUN
11-1007 - 11-1008
11-1007 33 cm
11-1008 36 cm



NAGELE
11-1009 - 11-1010
11-1009 36 cm
11-1010 40 cm



WRIGLEY
11-1011 - 11-1012
11-1011 23 cm
11-1012 28 cm



PIPER
11-1013
44.5 cm



KIELLAND
11-1014
41 cm



KIELLAND-LUIKART
11-1015
40 cm

Obstetrics-placenta And Ovum Forceps



Fig: 1
11-1016

Fig: 2
11-1017

Fig: 3
11-1018

Fig: 1
11-1019

Fig: 2
11-1020

Fig: 3
11-1021

WINTER
11-1016 - 11-1018
29 cm

WINTER
11-1019 - 11-1021
29 cm

LEWKOWIZ
11-1022
24.5 cm

Obstetrics-placenta And Ovum Cranioclast, Basiotribe Forceps



BRAUN
Cranioclast
11-1023
42 cm

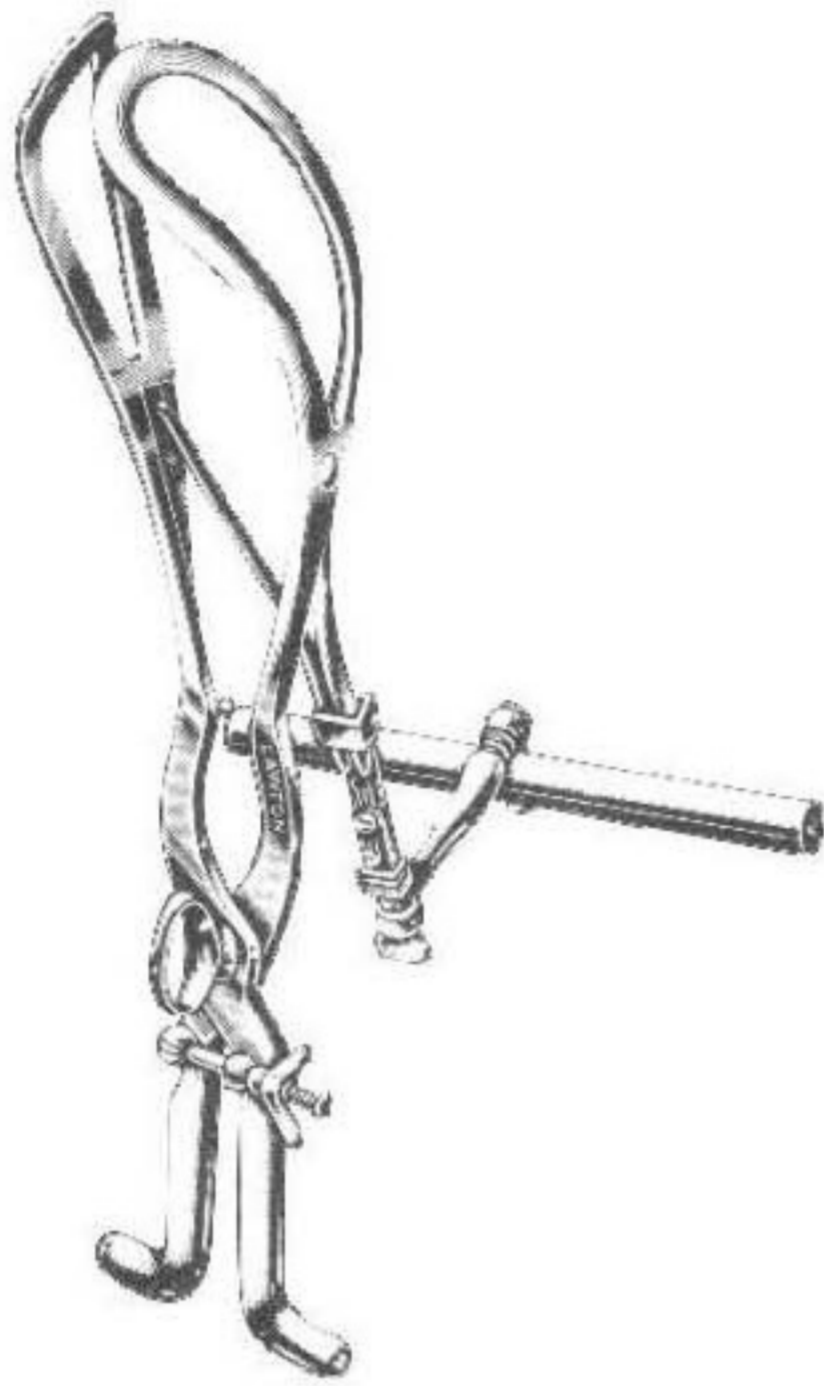

TARNIER
11-1024
40 cm

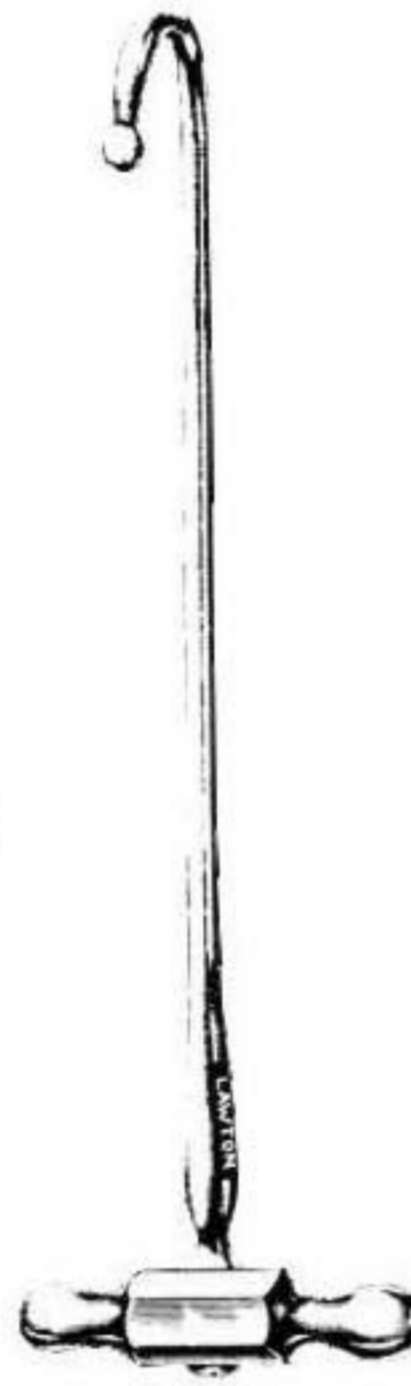

BRAUN
11-1025
31 cm



SMELLIE
11-1026
30.5 cm



BOER
11-1027
29 cm



SMELLIE
Perforator
11-1028
27 cm

Polypus And Ovum Forceps Haemorrhoidal Forceps



LUER
11-1029 - 11-1030
11-1029 22 cm
11-1030 24.5 cm

DOYEN
11-1031
18.5 cm

BUMM
11-1032
28 cm

Placenta And Ovum Forceps



**GREEN-ARMYTAGE
11-1033**
Caesarean section haemostatic
forceps, for edges of the transverse
incision in the lower segment
22 cm

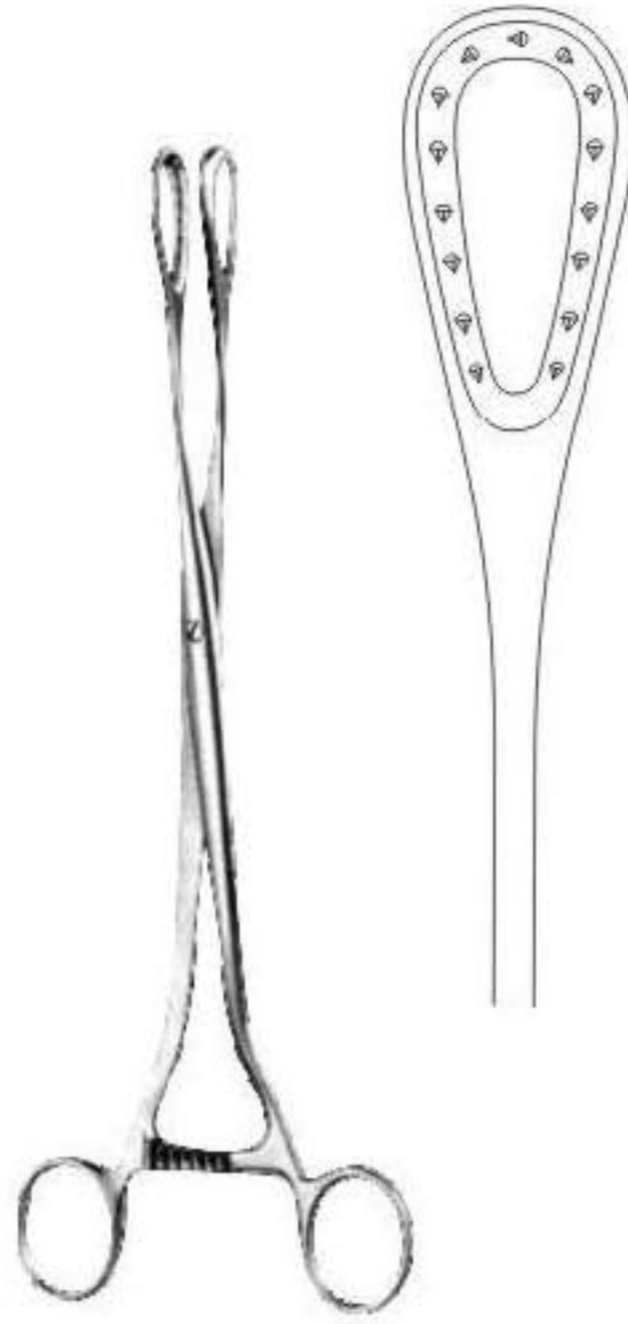

**SANGER
11-1034**
27.5 cm

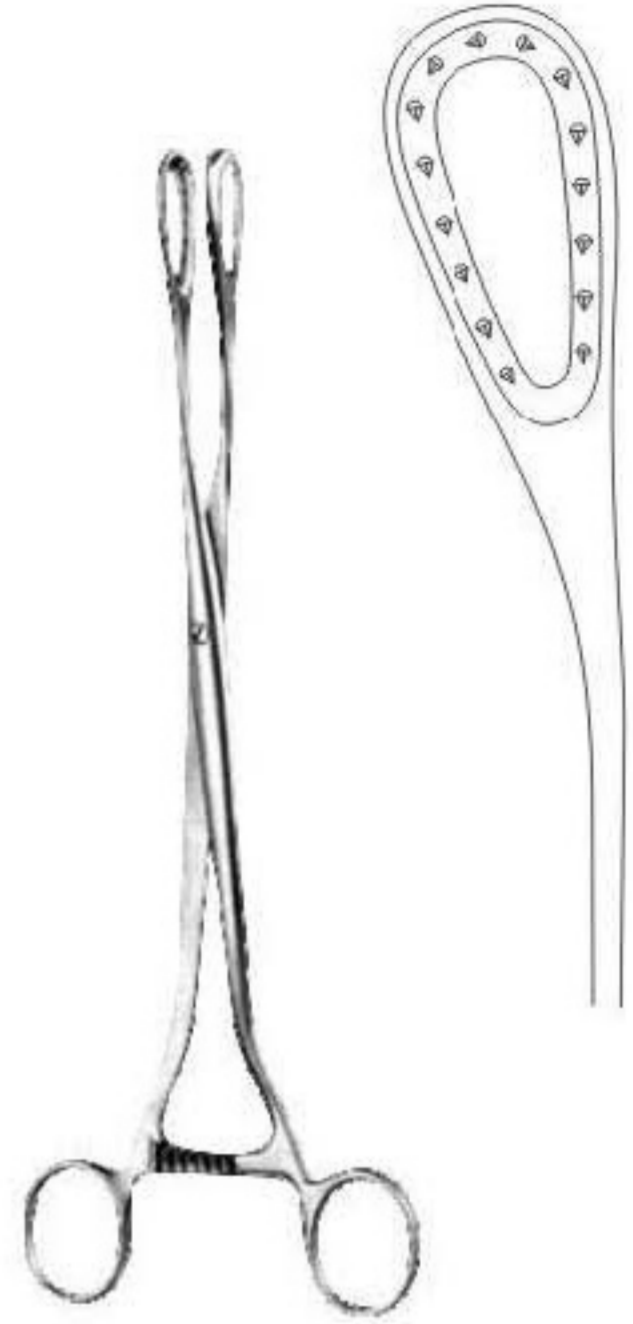

**SANGER
11-1035 - 11-1036**
11-1035 27 cm
11-1036 29 cm



**GAUSS
11-1037**
Scalpel Flap
forceps
26 cm



**WILLETT
11-1038**
Scalpel Flap
forceps
18.5 cm



**SELLHEIM
11-1039**
32 cm

Placenta Scoops, Umbilical Cord Clamps

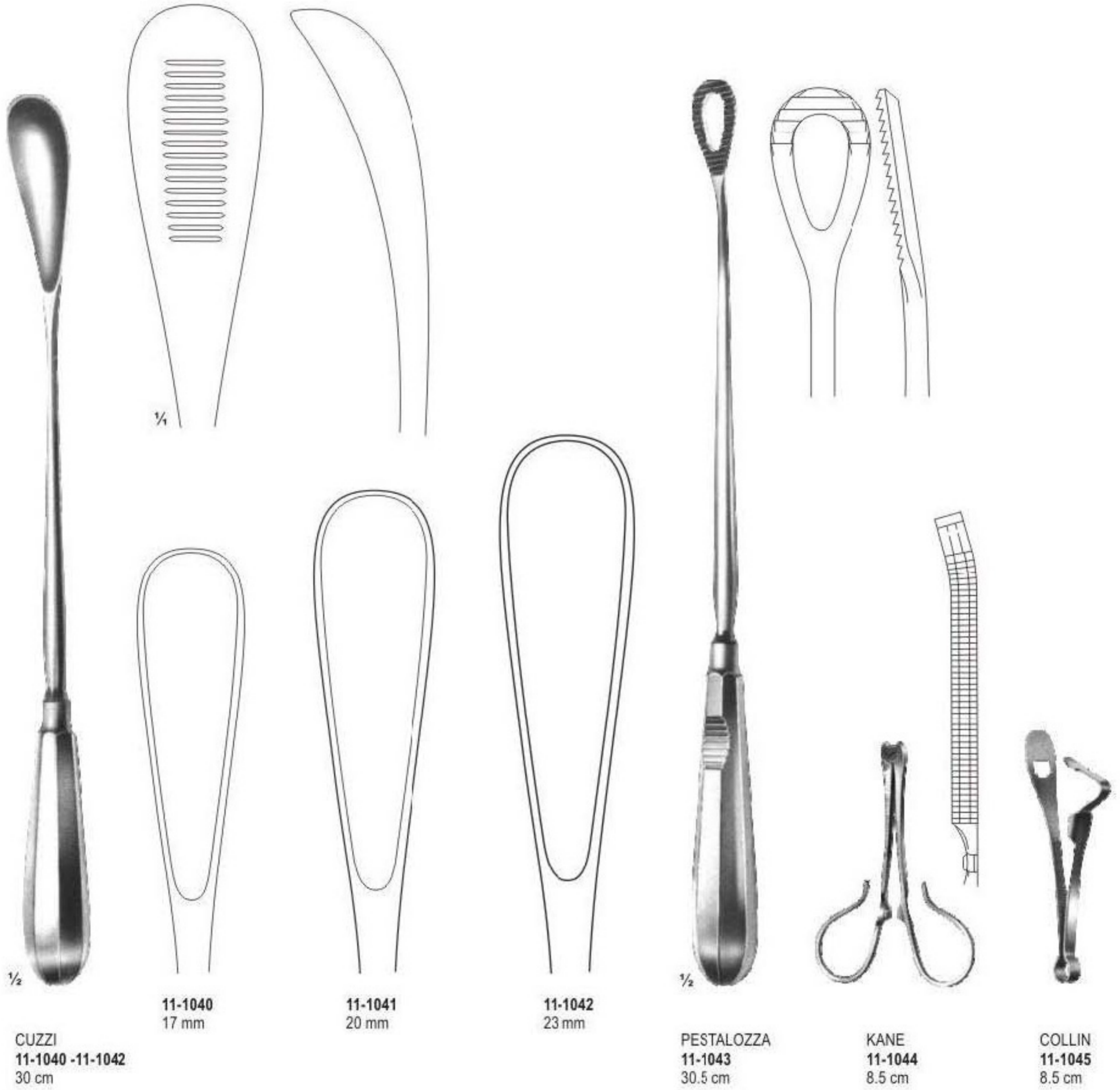

Page 262-268



- Plaster Instruments
- Plaster Scissors
- Scalpels, Tenotomes
- Plaster Shears
- Plaster Spreader, Plaster Breakers



Plaster Instruments



HOPKINS
12-1001
20 cm



ESMARCH
12-1002
18 cm



ENGEL
12-1003
16 cm



UNIVERSAL
12-1004 - 12-1012

- | | |
|----------------------|----------------------------|
| 12-1004 black | 12-1008 yellow |
| 12-1005 red | 12-1009 white |
| 12-1006 blue | 12-1010 orange |
| 12-1007 green | 12-1011 lavender |
| | 12-1012 bright pink |



UNIVERSAL
12-1013 - 12-1021

- | | |
|----------------------|----------------------------|
| 12-1013 black | 12-1017 yellow |
| 12-1014 red | 12-1018 white |
| 12-1015 blue | 12-1019 orange |
| 12-1016 green | 12-1020 lavender |
| | 12-1021 bright pink |

Plaster Scissors

For small plaster dressings



12-1022
16 cm



ESMARCH
12-1023 - 12-1024
12-1023 20 cm
12-1024 23 cm



BERGMANN
12-1025
23 cm

Plaster Scissors



BRUNS
12-1026
23.5 cm



also to be used as
bandage scissors

BRUNS
12-1027
23.5 cm



also to be used as
bandage scissors

SEUTIN
12-1028
23 cm

Plaster Scissors



1/2

LISTER
12-1029
23.5 cm

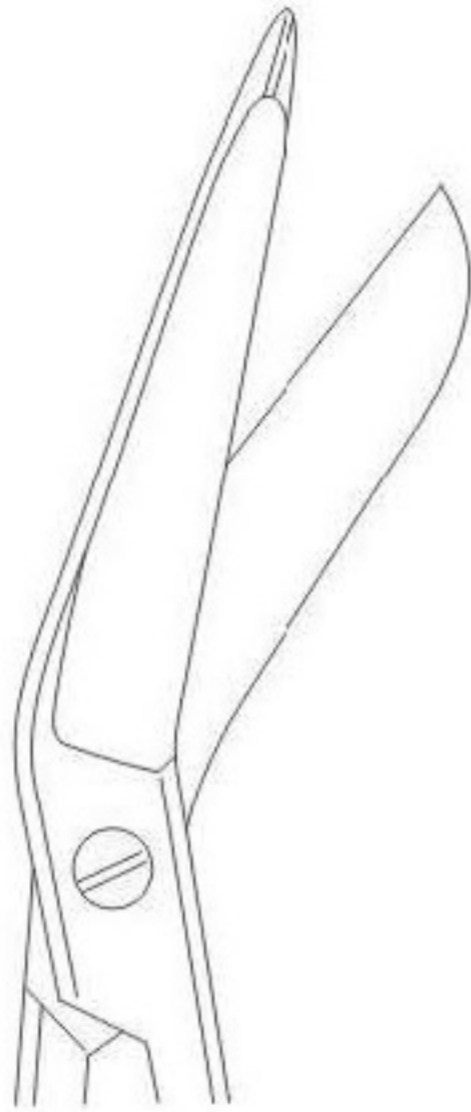

1/2

BRUNS
12-1030
23.5 cm

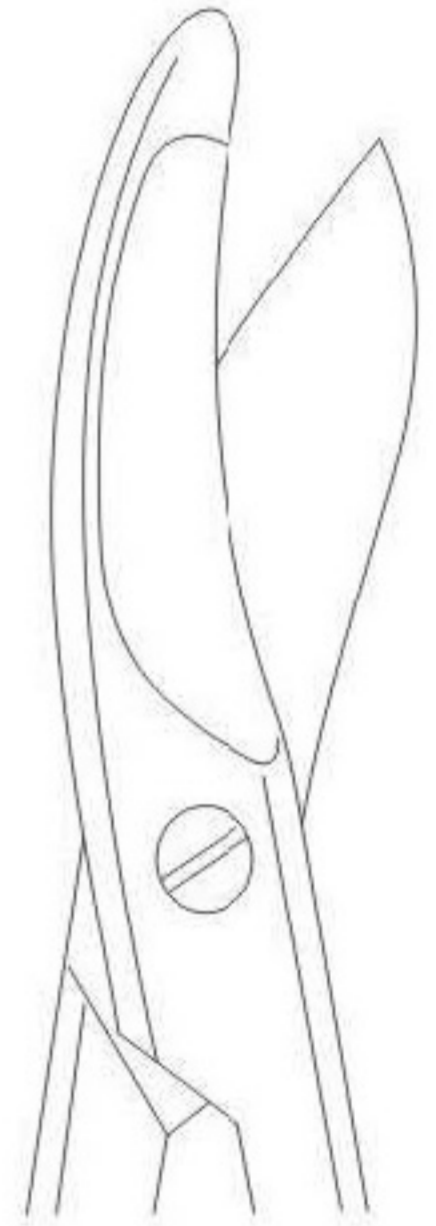

Plaster Shears



STILLE-AESFULAP
12-1031
26 cm



STILLE-AESFULAP
12-1032
36 cm

Plaster Shears

Blade with reinforced back



STILLE
12-1033
23 cm

12-1034
Spare blade



STILLE
12-1035
37 cm

12-1036
Spare blade



STILLE
12-1037
24 cm

12-1038
Spare blade

Plaster Spreader, Plaster Breakers



HENNING
12-1039
27 cm



MOD. USA
12-1040
23 cm



12-1041
29 cm



with removable jaws



WOLFF
12-1042 - 12-1043
12-1042 18 cm
12-1043 24 cm

Page 269-292



- Ear Specula
- Ear Curettes
- Sharp Spoons
- Ear Loops - Hooks
- Paracentesis Needles
- Ear Forceps & Micro Ear Forceps
- Micro Ear Raspatories & Probes Ear
- Sicklines - Cricular Cutting Knife
- MicroEar Needles Holders & Hooks Micro Ear Raspatories
- Micro Ear - Spoons
- Bone Rongeur
- Nasal Specula
- Nasal Polypus & Septum Forceps Nasal Dressing Forceps
- Nasal Cutting Forceps
- Probes
- Circular Forceps & Antrum Punch
- Tonsil Knives
- Septum Elevators
- Periosteal Elevators
- Nasal Rasps
- Rasps With & Without Tungsten Carbide
- Septum Forceps
- Broncho - Oesophagoscopy forceps
- Blood Lancets & Laryngeal Mirrors



Micro Ear Forceps



Micro Ear Forceps
13-1001 - 13-1005



13-1001
Straight, oval
X = 75 mm



13-1002
Curved upwards, oval
X = 75 mm

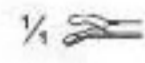

13-1003
Curved to left, oval
X = 75 mm



13-1004
Curved to right, oval
X = 75 mm



13-1005
Curved downwards, oval
X = 75 mm



BELUCCI
13-1006 - 13-1010



13-1006
Straight,
sharp/sharp
X = 75 mm

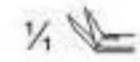

13-1007
Curved upwards,
blunt/blunt
X = 75 mm



13-1008
Curved to right,
sharp/sharp
X = 75 mm

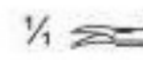

13-1009
Curved to left,
sharp/sharp
X = 75 mm



13-1010
straight,
sharp/blunt
X = 75 mm

Ear Forceps And Micro Ear Forceps



13-1011 - 13-1017

HARTMANN - WEINGARTNER
13-1015
X = 85 mm

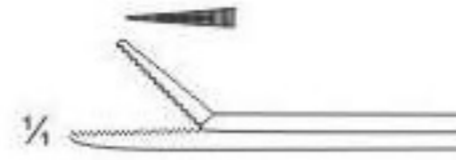

HARTMANN - WULLSTEIN
13-1011
X = 85 mm



HARTMANN - WULLSTEIN
13-1012
X = 85 mm

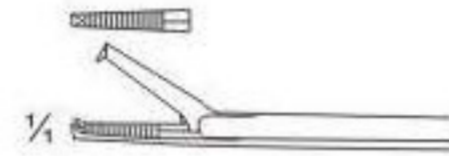

HARTMANN
13-1013
X = 85 mm
X = 140 mm

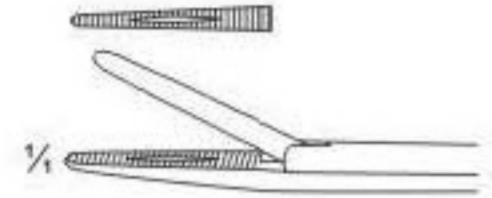

HARTMANN - NOYES
13-1014
X = 90 mm

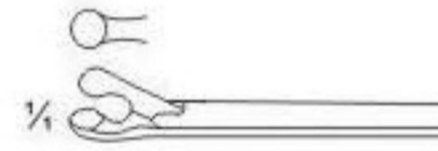

HARTMANN
13-1016
X = 85 mm
2.0 mm Ø
2.5 mm Ø
3.0 mm Ø



STRUEMPEL
13-1017
X = 85 mm



DIETER
13-1018 - 13-1023
malleus nipper
X = 80 mm



MCGEE
13-1018
wire bending forceps
3.5 mm X 0.8 mm



FULLER
13-1019
introducing forceps
for teflon prosthesis
80 mm



13-1020
Up - cutting



13-1021
Down - cutting



13-1022
Right - cutting

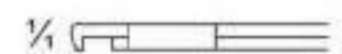

13-1023
Left - cutting

Nasal Cutting Forceps Circular Forceps And Antrum Punch

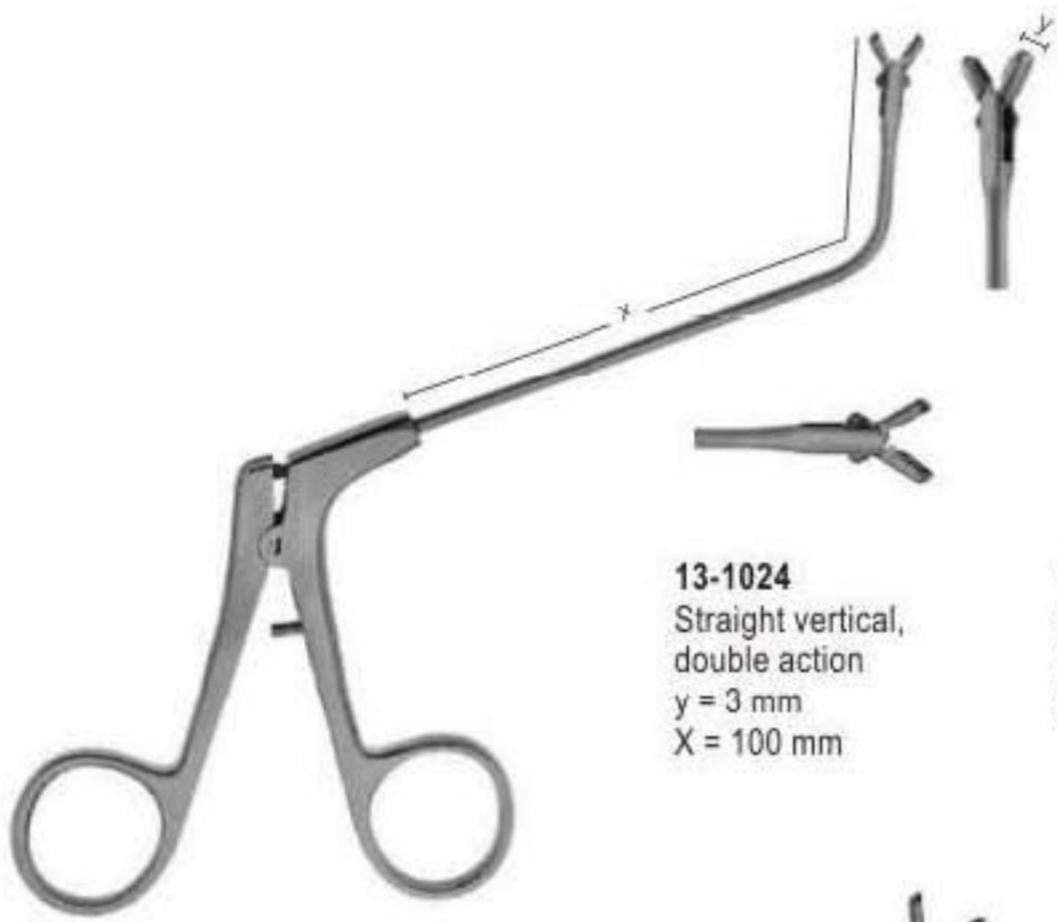

13-1024 - 13-1030

13-1024
Straight vertical,
double action
y = 3 mm
X = 100 mm

13-1025
Straight, double action
y = 3 mm
X = 100 mm

13-1026
45° Vertical, double action
y = 3 mm
X = 100 mm

13-1027
45° double action
y = 3 mm
X = 100 mm



13-1028
70° vertical, double action
y = 3 mm
X = 100 mm



13-1029
70° double action
y = 3 mm
X = 100 mm



13-1030
110° double action
y = 3 mm
X = 100 mm

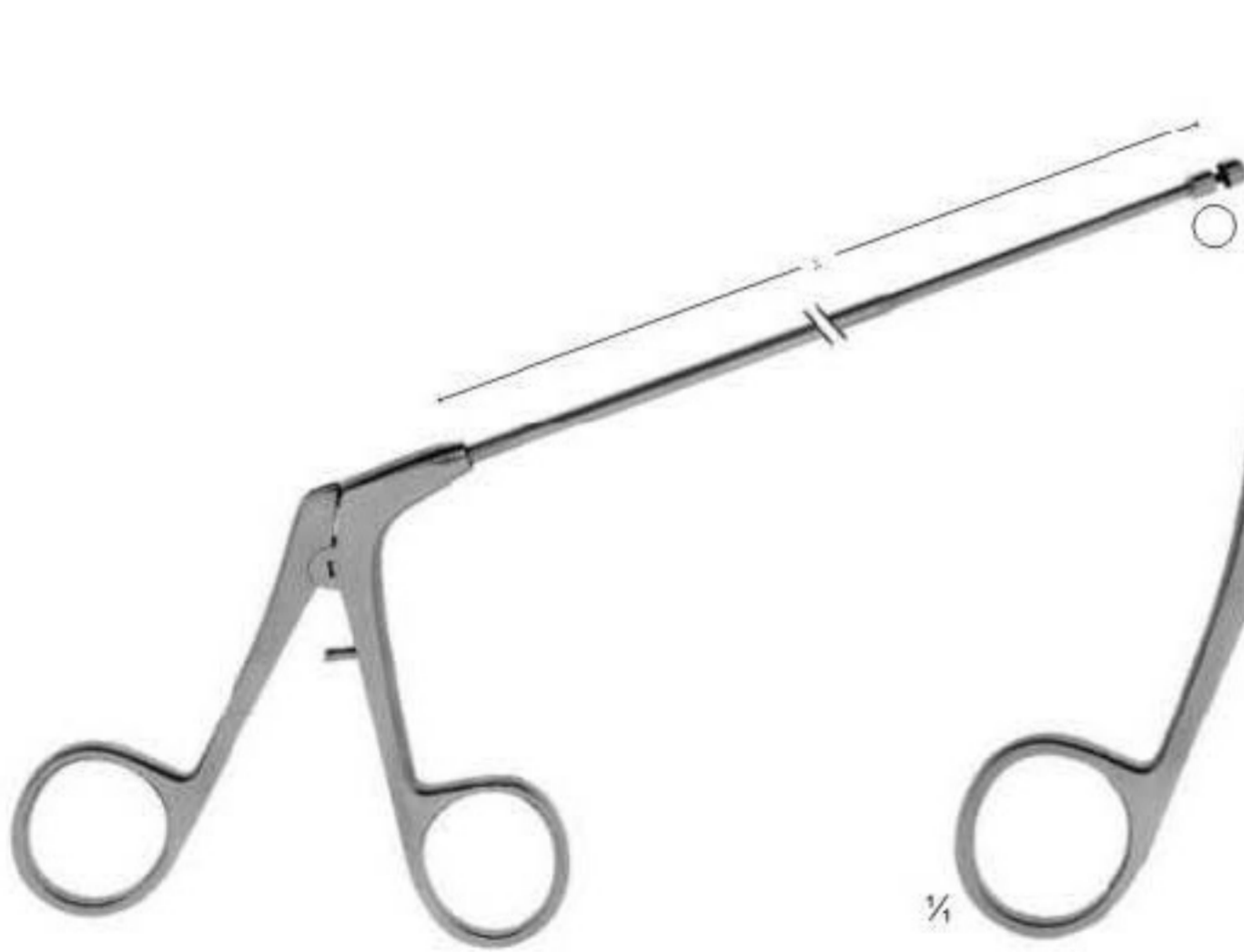

13-1031
Straight curved upwards
X = 180 mm
3.5 mm Ø
4.5 mm Ø



13-1032
X = 100 mm
1.5 mm X 4.5 mm

Fig.1 backward, up-cutting
Fig.2 backward, cut to the right
Fig.2 backward, cut to the left

Nasal Cutting Forceps



WEIL - BLAKESLEY
13-1033 - 13-1037



13-1033
X = 120 mm



13-1034
X = 120 mm

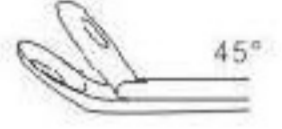

13-1035
X = 180 mm



13-1036
X = 120 mm



13-1037
X = 180 mm



HARTMANN
13-1038 - 13-1044
X = 120 mm

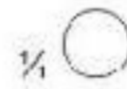

13-1038



13-1039

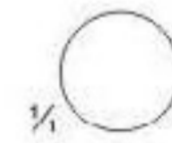

13-1040

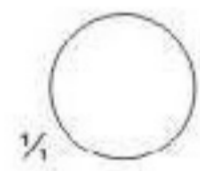

13-1041

MYLES

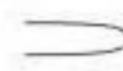

Fig.1
13-1042
2.0 X 10.0 mm

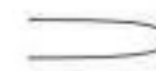

Fig.2
13-1043
2.5 X 12.0 mm



Fig.3
13-1044
3.0 X 14.0 mm

Ear Curettes And Sharp Spoons

11/2013

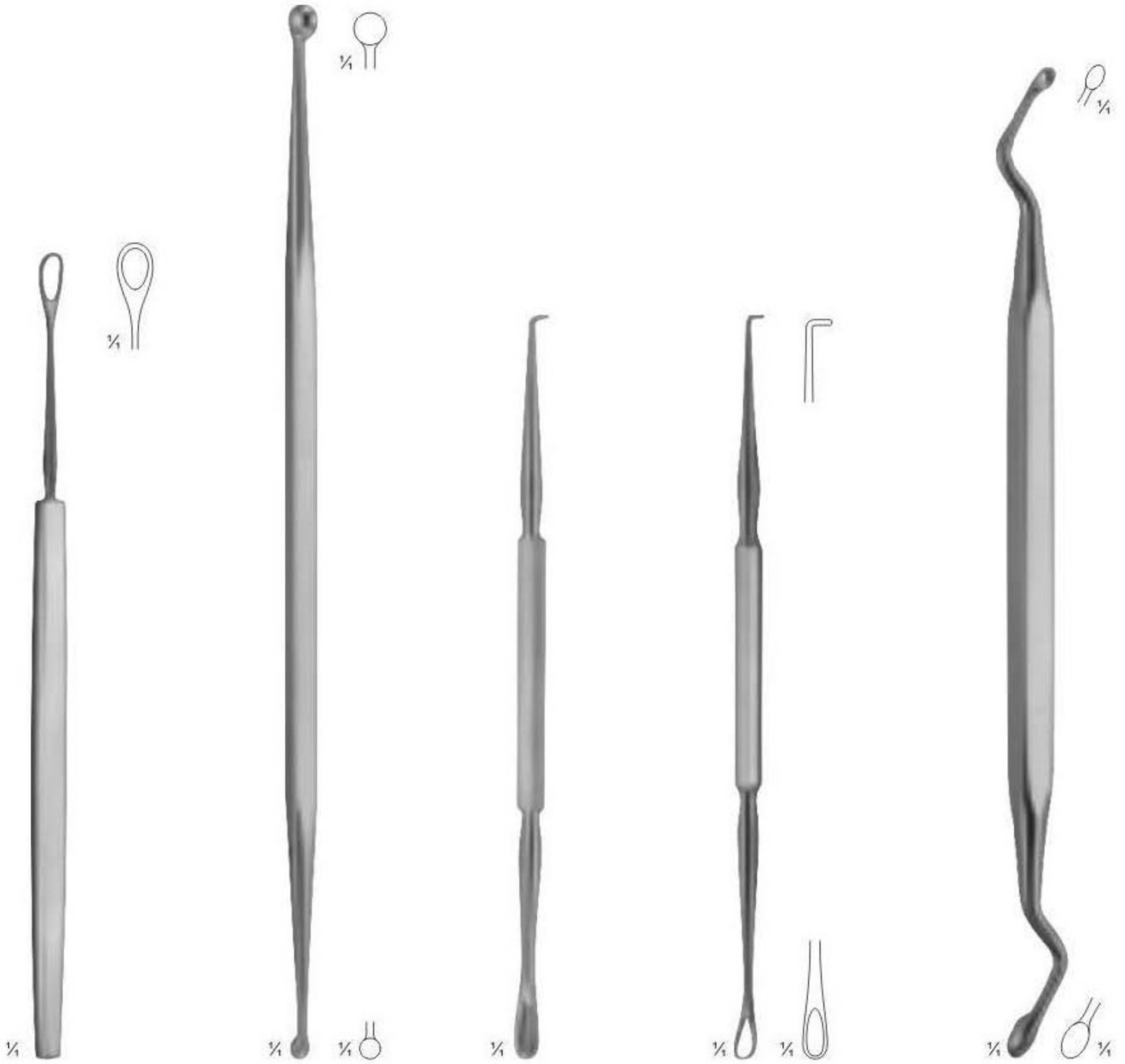

LANGENBECK
13-1045
Blunt
13 cm

JANSEN
13-1046
Sharp
17 cm

GROSS
13-1047
Sharp, not fenestrated
12 cm

13-1048
Blunt, fenestrated
12 cm

JANSEN
13-1049
Sharp
16 cm

Ear Curettes



BUCK
13-1050 - 13-1065
Blunt Sharp
16.5 cm



Fig.000
13-1050



Fig.00
13-1051



Fig.0
13-1052



Fig.1
13-1053



Fig.2
13-1054



Fig.3
13-1055



Fig.4
13-1056



Fig.5
13-1057



Fig.000
13-1058



Fig.00
13-1059



Fig.0
13-1060



Fig.1
13-1061



Fig.2
13-1062



Fig.3
13-1063



Fig.4
13-1064



Fig.5
13-1065



BUCK
13-1066 - 13-1081
Curved, blunt
Curved, sharp
16.5 cm



Fig.000
13-1066



Fig.00
13-1067



Fig.0
13-1068



Fig.1
13-1069



Fig.2
13-1070



Fig.3
13-1071



Fig.4
13-1072



Fig.5
13-1073



Fig.000
13-1074



Fig.00
13-1075



Fig.0
13-1076



Fig.1
13-1077



Fig.2
13-1078



Fig.3
13-1079



Fig.4
13-1080



Fig.5
13-1081

Pictures Show The Outer Diameter

Ear Specula



¼

ZÖLLNER
13-1082 - 13-1087
set for adults, black

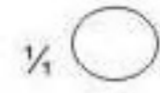

Fig.1
13-1082
5.5 X 6.5 mm Ø



Fig.2
13-1083
6.5 X 7.5 mm Ø



Fig.3
13-1084
7.5 X 8.5 mm Ø

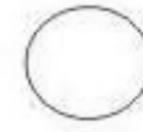

Fig.4
13-1085
8.5 X 9.5 mm Ø

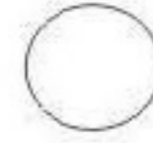

Fig.5
13-1086
9.5 X 10.5 mm Ø

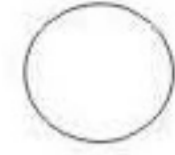

Fig.6
13-1087
10.5 X 11.5 mm Ø



¼

POLITZER
13-1088 - 13-1091
set for adults



Fig.1
13-1088
2 mm Ø



Fig.2
13-1089
3 mm Ø



Fig.3
13-1090
4 mm Ø



Fig.4
13-1091
5 mm Ø



¼

BOUCHERON
13-1092 - 13-1094
set for children

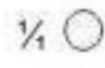

Fig.0
13-1092
3.0 mm Ø



Fig.1
13-1093
4.5 mm Ø



Fig.2
13-1094
5.5 mm Ø



¼

HARTMANN
13-1095 - 13-1098
set for adults

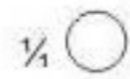

Fig.1
13-1095
4.5 mm Ø



Fig.2
13-1096
5.5 mm Ø



Fig.3
13-1097
6.5 mm Ø



Fig.4
13-1098
7.5 mm Ø

Micro Ear Raspatories And Probes Ear Sickle knives - Circular Cutting Knife



PLESTER
13-1099 - 13-1104
16 cm



WIRE GUIDE
13-1099



RASPATORY
13-1100



RASPATORY
13-1101
1.8 mm



13-1102
Dissector, double
curved right



13-1103
Instrument for placing
wire prothesis



13-1104
Dissector, double
curved left



ROSEN
13-1105 - 13-1111
16 cm



13-1105
Circular cutting knife
1.5 mm \varnothing - 90°



13-1106
Tympanum knife
45°



13-1107
Lancet knife
45°



13-1108
Lancet knife



RASPATORY
13-1109
Zollner
1 mm



13-1110
Sickle knife,
slightly curved



13-1111
discision knife,
straight curved

Micro Ear Needles And Hooks Micro Ear Raspatories



13-1112 - 13-1117



13-1112
Needle fine, straight, sharp
16 cm



13-1113
Needle, slightly curved, sharp
16 cm



13-1114
Needle, strong curved, sharp
16 cm



0.4 mm
0.6 mm
0.8 mm
1.0 mm

SHAMBAUGH
13-1115
45° Hook, angled
16 cm



PLESTER
13-1116
0.4 mm - 90°
foot plate hook, angled, blunt
16 cm



PLESTER
13-1117
0.4 mm - 45°
Antrum hook, angled, blunt
16 cm



FISCH
13-1118 - 13-1121



13-1118
Angled to the right
15.5 cm



13-1119
Angled to the left
15.5 cm



13-1120
Angled to the right
15.5 cm





13-1121
Angled to the left
15.5 cm

Bone Rongeur



1/2
CITELLI
13-1122 - 13-1124
17 cm
X = 60 mm

13-1122
1.5 mm

13-1123
2.2 mm

13-1124
3 mm



1/2
KERRISON
13-1125 - 13-1128
20 cm
X = 80 mm



13-1125
3 X 3 mm

13-1126
4 X 4 mm

13-1127
5 X 5 mm

13-1128
6 X 6 mm

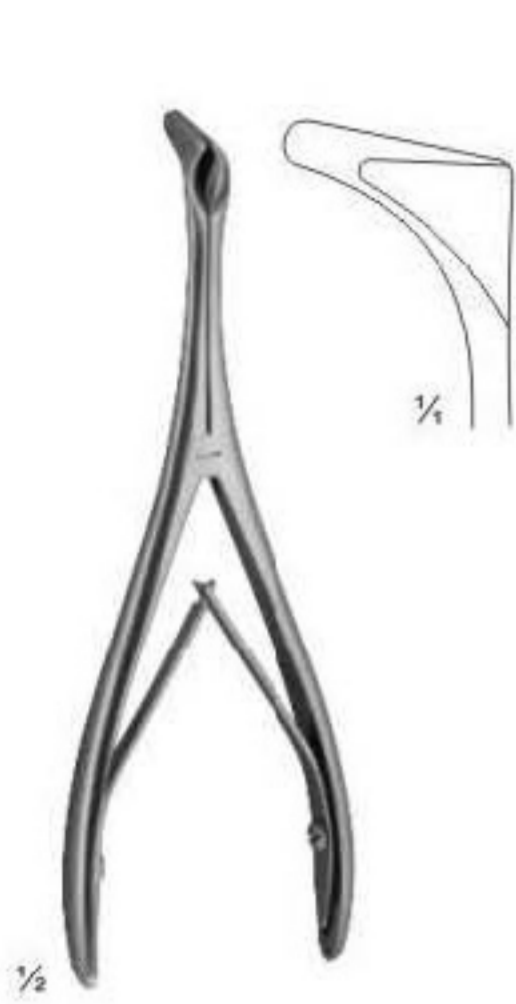
Nasal Specula



TIECK - HALLE
13-1129
for babies
13.5 cm



BECKMANN
13-1130
15 cm



MOD. WIEN
13-1131
14.5 cm

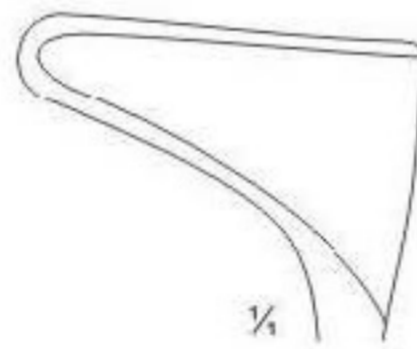
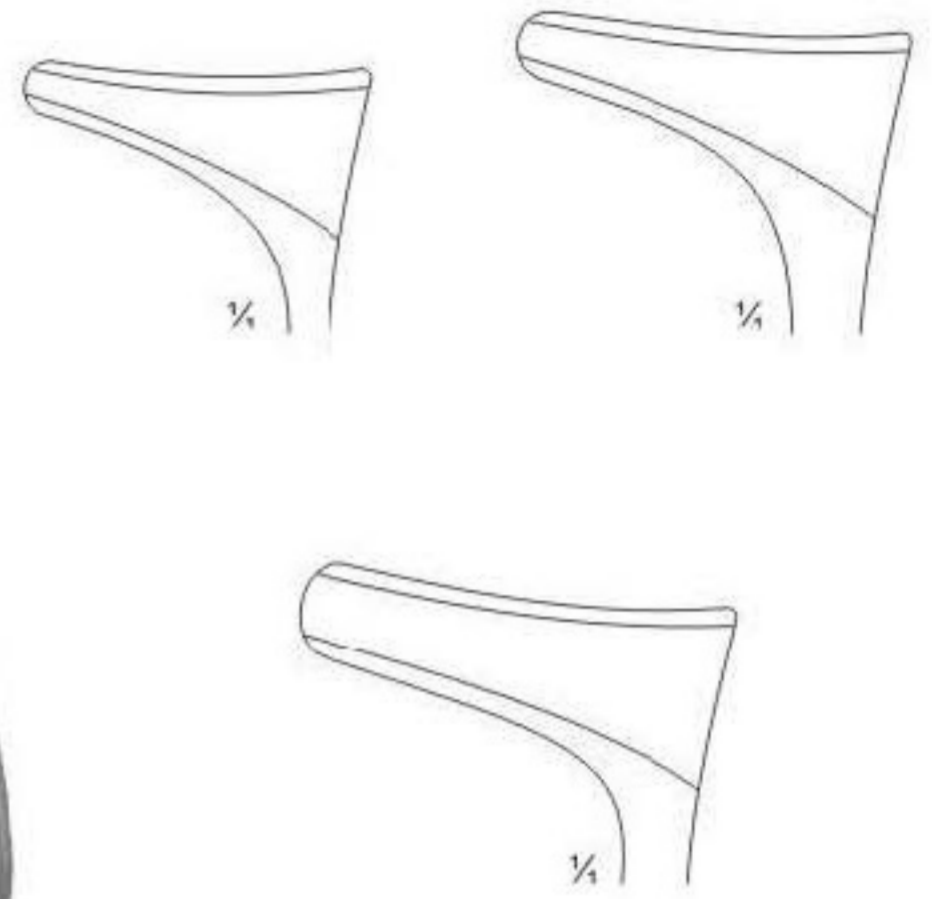

13-1132
X = 35 mm

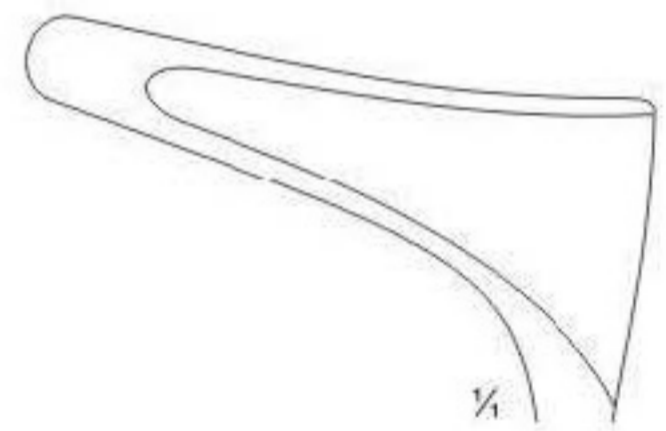

13-1133
X = 50 mm



KILLIAN
13-1132 - 13-1135
13 cm

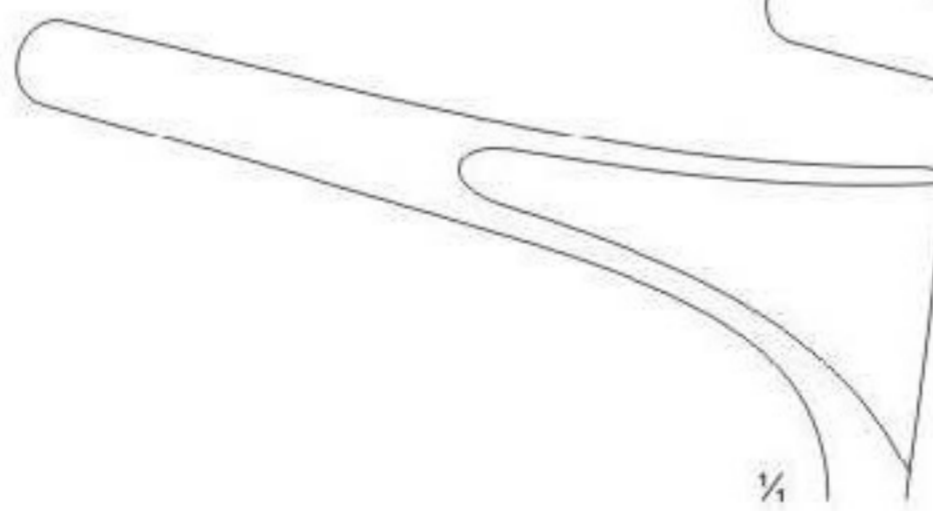

13-1134
X = 75 mm

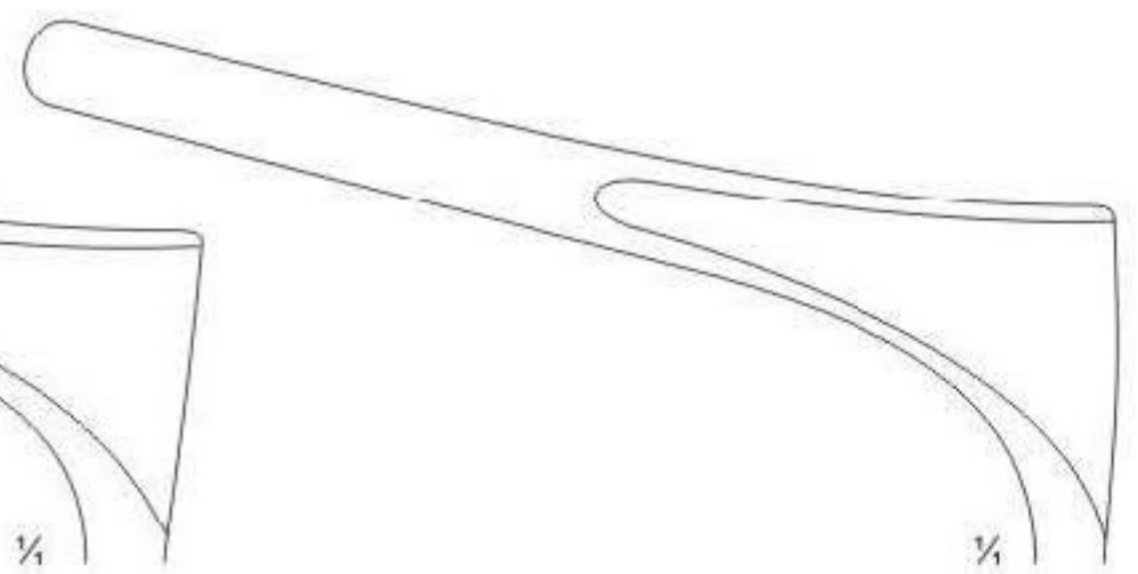

13-1135
X = 90 mm

Nasal Polypus And Septum Forceps Nasal Dressing Forceps



WESTMACOTT
13-1136
20 cm



LUBET - BARBON
13-1137
20 cm



HARTMANN
13-1138 - 13-1139
13-1138 16 cm
13-1139 20 cm

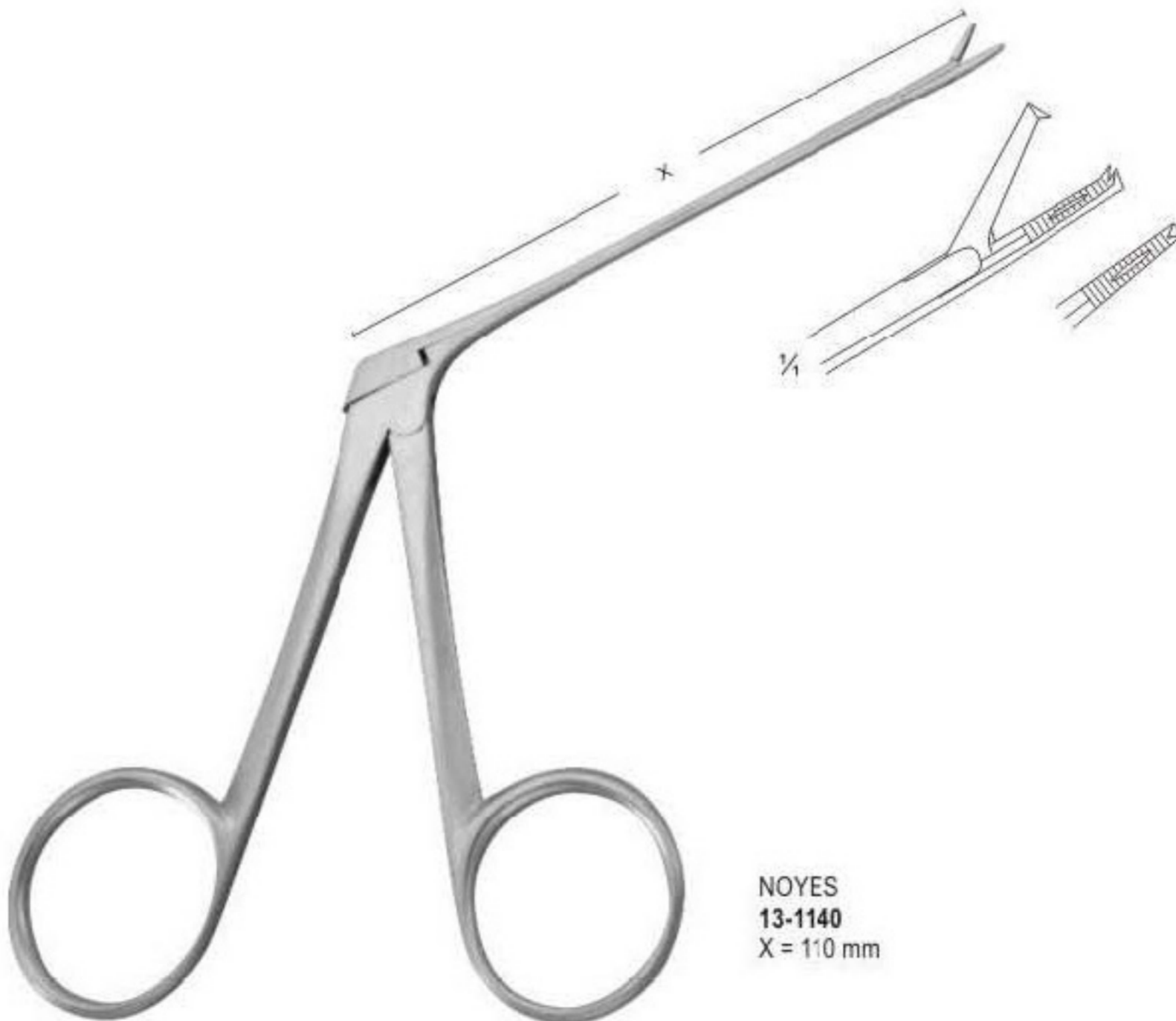

NOYES
13-1140
X = 110 mm

Nasal Cutting Forceps

04/2020



LUC
13-1141 - 13-1144
20 cm



Fig.1
13-1141
Fenestrated



Fig.2
13-1142
Fenestrated



Fig.1
13-1143
Plain



Fig.2
13-1144
Plain



TAKAHASHI
13-1145 - 13-1147



13-1145
X = 120 mm

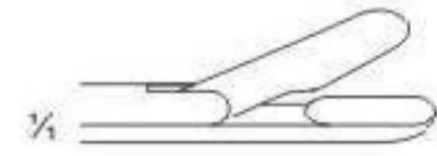

13-1146
3.5 mm X 10 mm

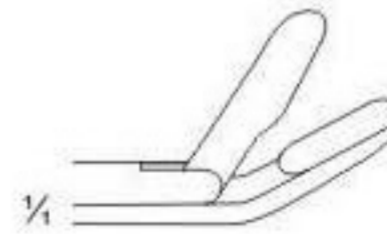

13-1147
3.5 mm X 10 mm

Ear Loops - Hooks



13-1148



13-1149



13-1150

BILLEAU
13-1148 - 13-1150
16.5 cm



13-1151



13-1152



13-1153

LUCAE
13-1151 - 13-1153
14 cm



13-1154



13-1155



13-1156



13-1157



13-1158



13-1159



13-1160

WAGENER
13-1154 - 13-1160
14 cm

Paracentesis Needles

13-1160



Paracentesis Needles
13-1161 - 13-1163



POLITZER
13-1161
15 cm



GERZOG
13-1162
16 cm



BUCK
13-1163
16 cm



LUCAE
13-1164
18 cm



LUCAE
13-1165
18 cm



LUCAE
13-1166
19 cm



POLITZER
13-1167
17 cm



POLITZER
13-1168
needle vertical
16 cm



Paracentesis Needles
13-1169
Needle horizontal
16 cm

Tonsil Knives



½
FREER
13-1170
21 cm



½
FREER
13-1171
21 cm



½
SICKLE KNIFE
13-1172
20 cm



½
BRUENINGS
13-1173
23 cm



½
ABRAHAM
13-1174
22 cm



½
FISCHER
13-1175
23 cm



½
SHARP
13-1176
20 cm

Septum Elevators



LEMPERT
13-1177
20 cm
X = 6 mm

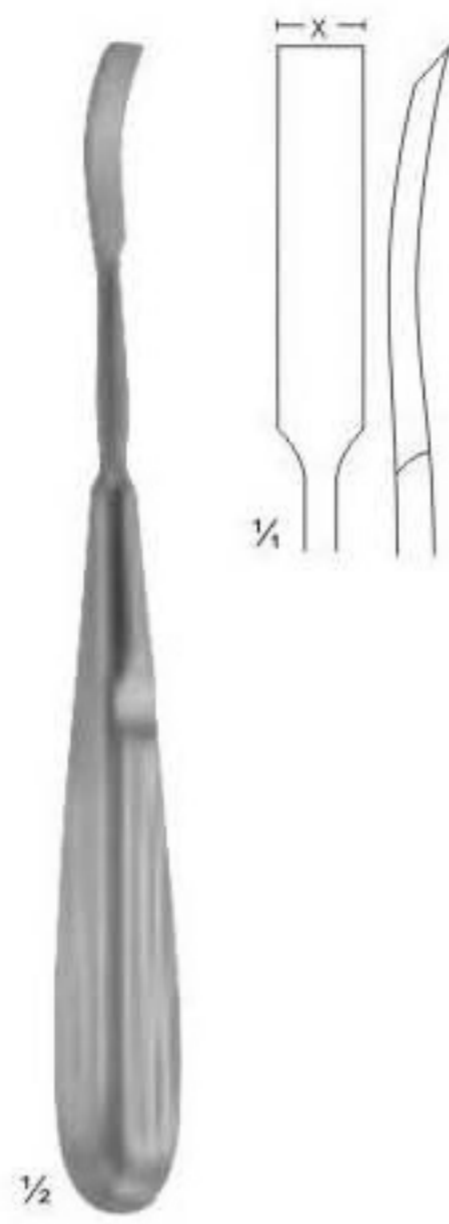

LEMPERT
13-1178
18 cm



FREER
13-1179
16 cm
X = 4 mm

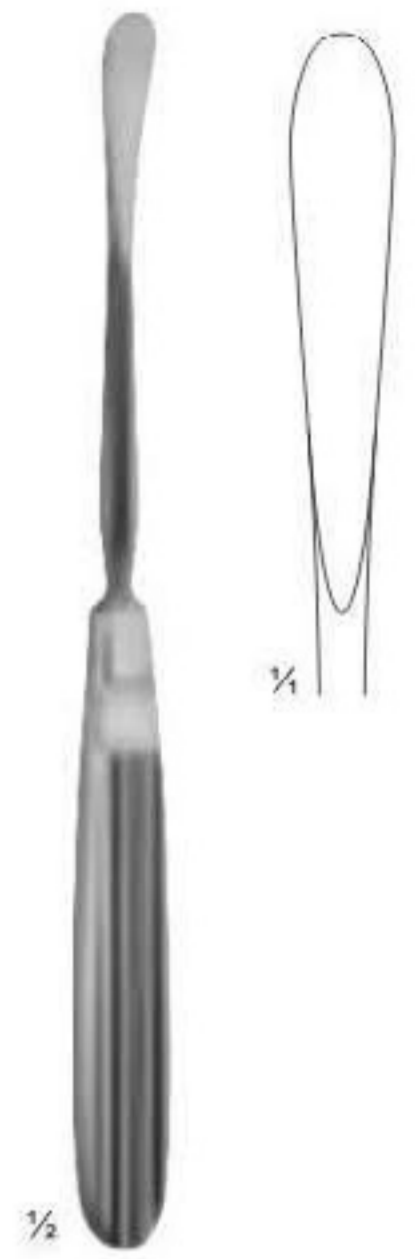

COTTLE
13-1180
sharp
19 cm
X = 8 mm

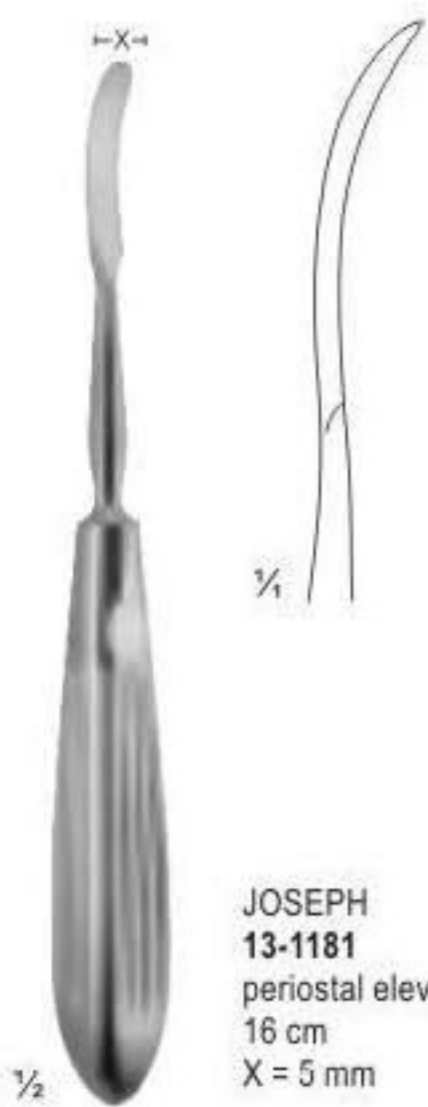

JOSEPH
13-1181
periosteal elevators
16 cm
X = 5 mm



SEWALL
13-1182
antrum elevators
20 cm



HALLE
13-1183
antrum elevators
16 cm

Periosteal Elevators



MASING
13-1184
20 cm



BALLENGER - HAJEK
13-1185 - 13-1186
13-1185 19 cm
13-1186 22 cm

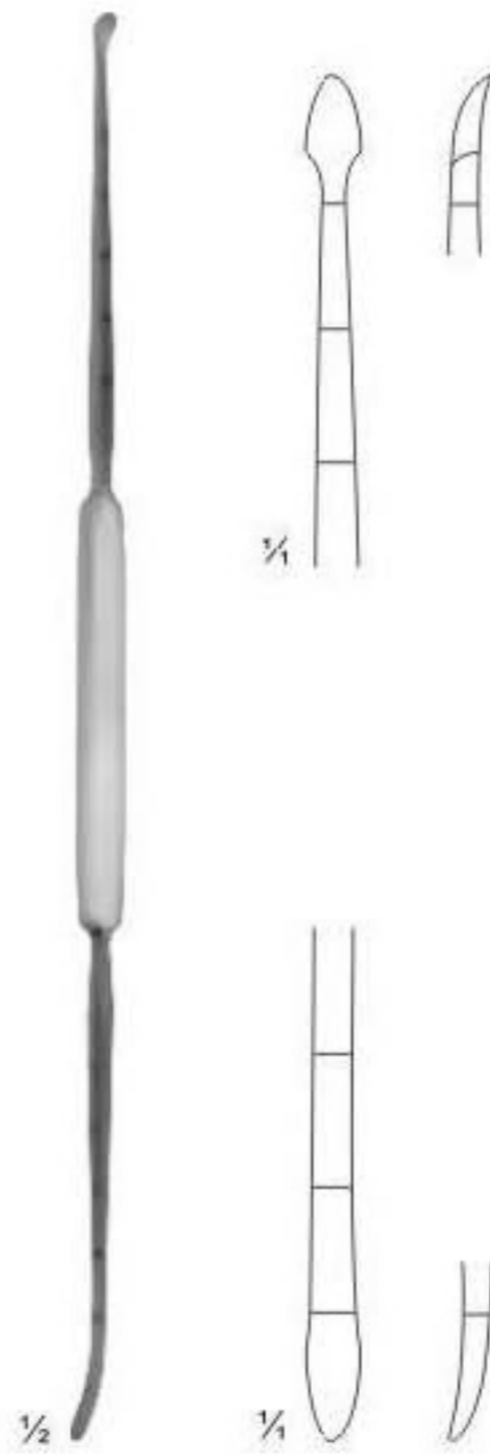

COTTLE
13-1187
22 cm

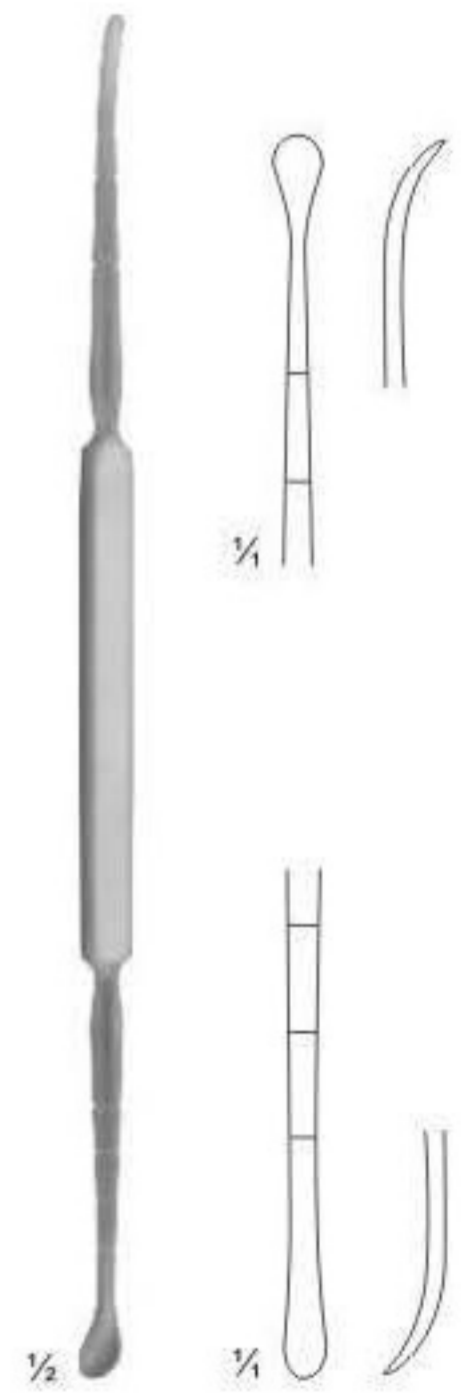

COTTLE
13-1188
21 cm

Nasal Rasps



1/2

COTTLE
13-1189
21 cm

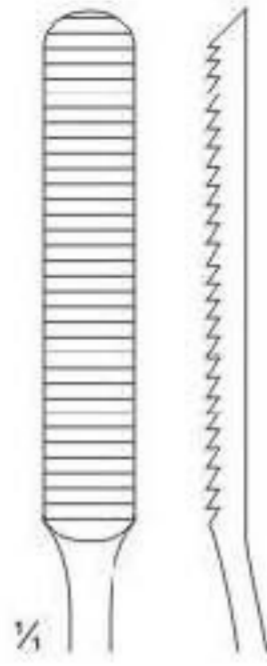

1/4



1/2

MALTZ
13-1190 - 13-1191

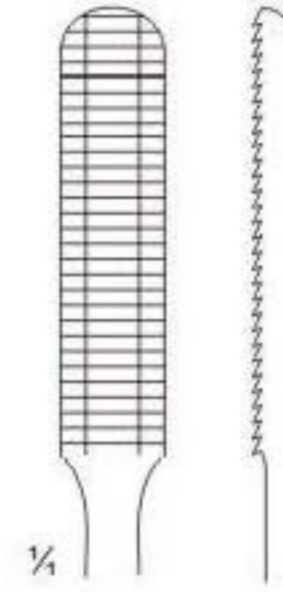

1/4

13-1190
Drawing cut
17 cm
34 mm X 7 mm



1/4

13-1191
Pushing cut
17 cm
34 mm X 7 mm



1/2

AUFRICHT
13-1192 - 13-1193

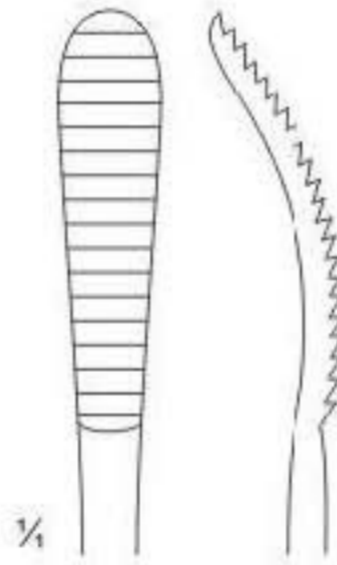

1/4

13-1192
Pushing cut
21 cm



1/4

13-1193
Drawing cut
21 cm

Rasps With Tungsten Carbide



¼
FOMON
13-1194 - 13-1203
20 cm



¼

13-1194
Fig.1
12



¼

13-1195
Fig.3
16



¼

13-1196
Fig.5
24



¼

13-1197
Fig.7
36

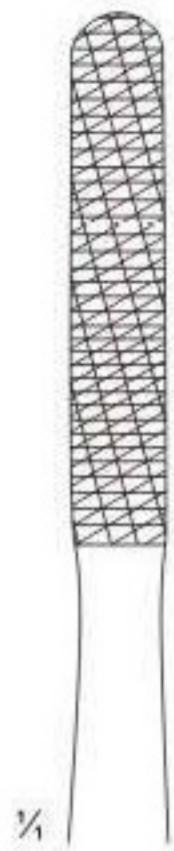

¼

13-1198
Fig.9
52

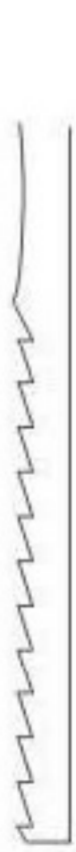

¼

13-1199
Fig.2
14



¼

13-1200
Fig.4
20



¼

13-1201
Fig.6
30



¼

13-1202
Fig.8
44



¼

13-1203
Fig.10
62

Septum Forceps



1/2

COTTLE-WALSHAM
13-1204 · 13-1206

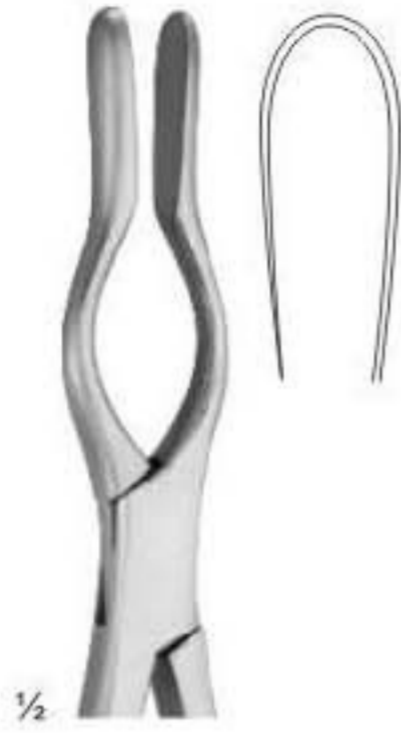

1/2

13-1204
Straight



1/2

13-1205
Left



1/2

13-1206
Right



1/2

ASCH
13-1207
23 cm



1/4

Septum Forceps

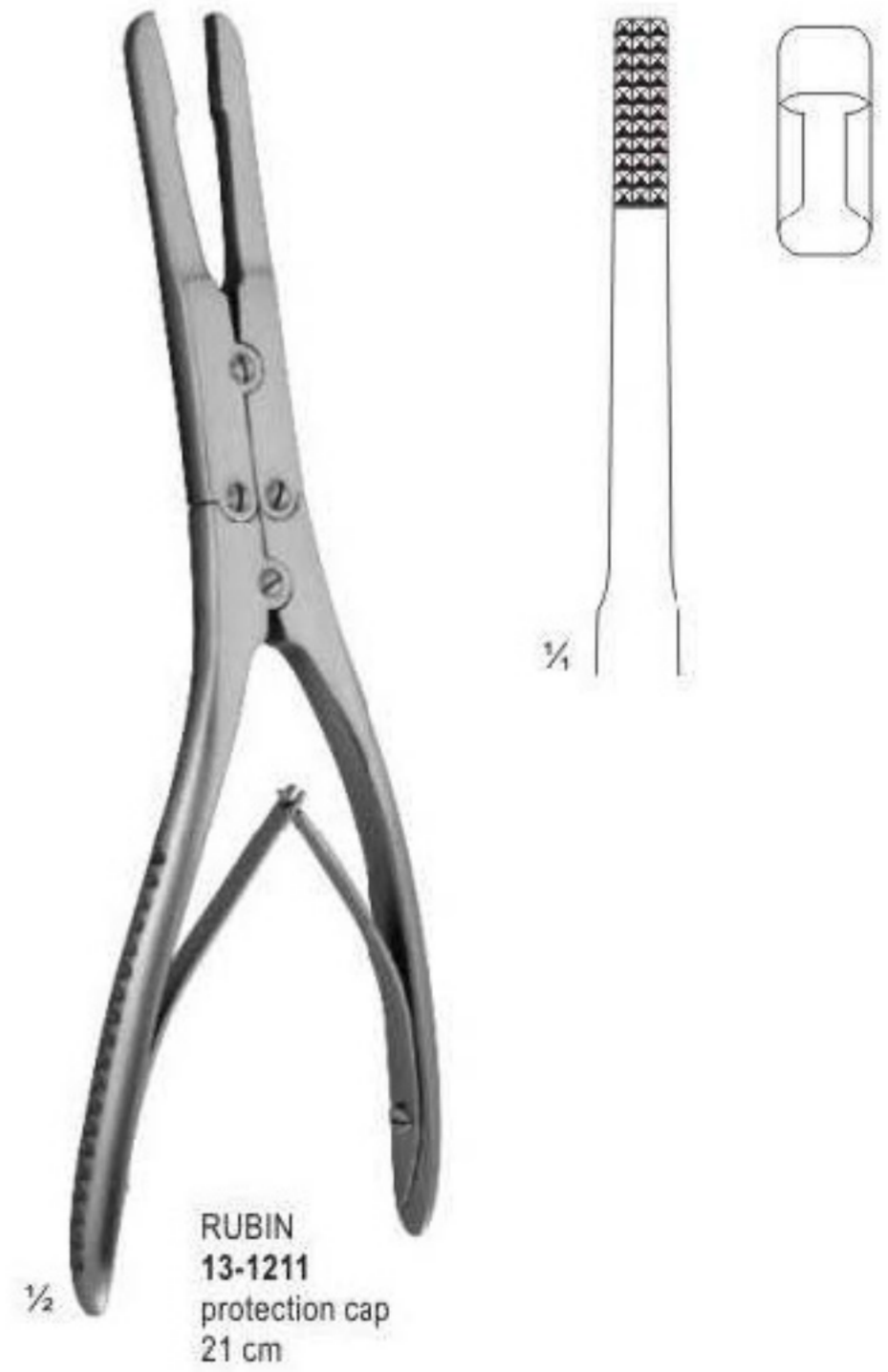
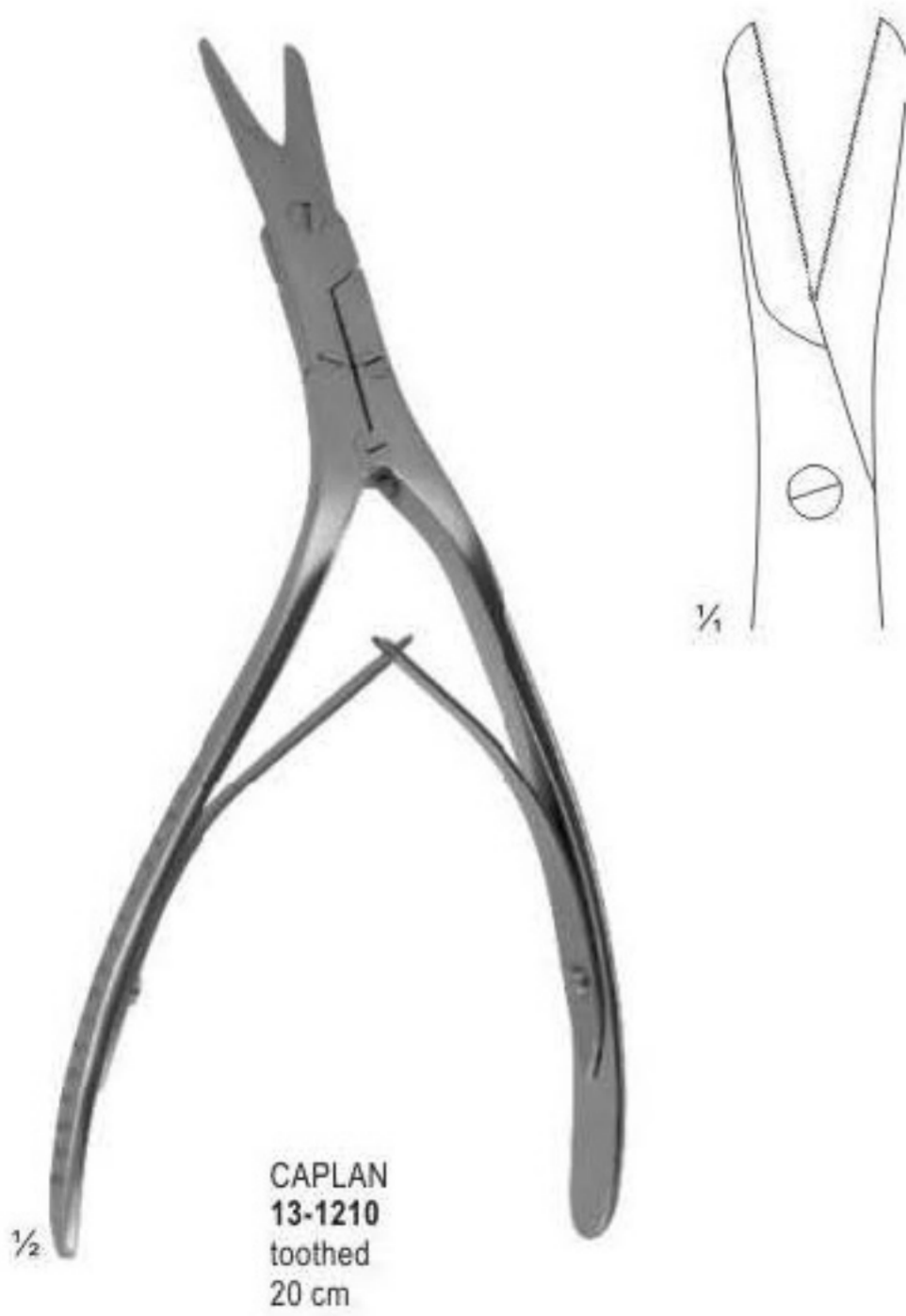

Broncho - Oesophagoscopy Forceps

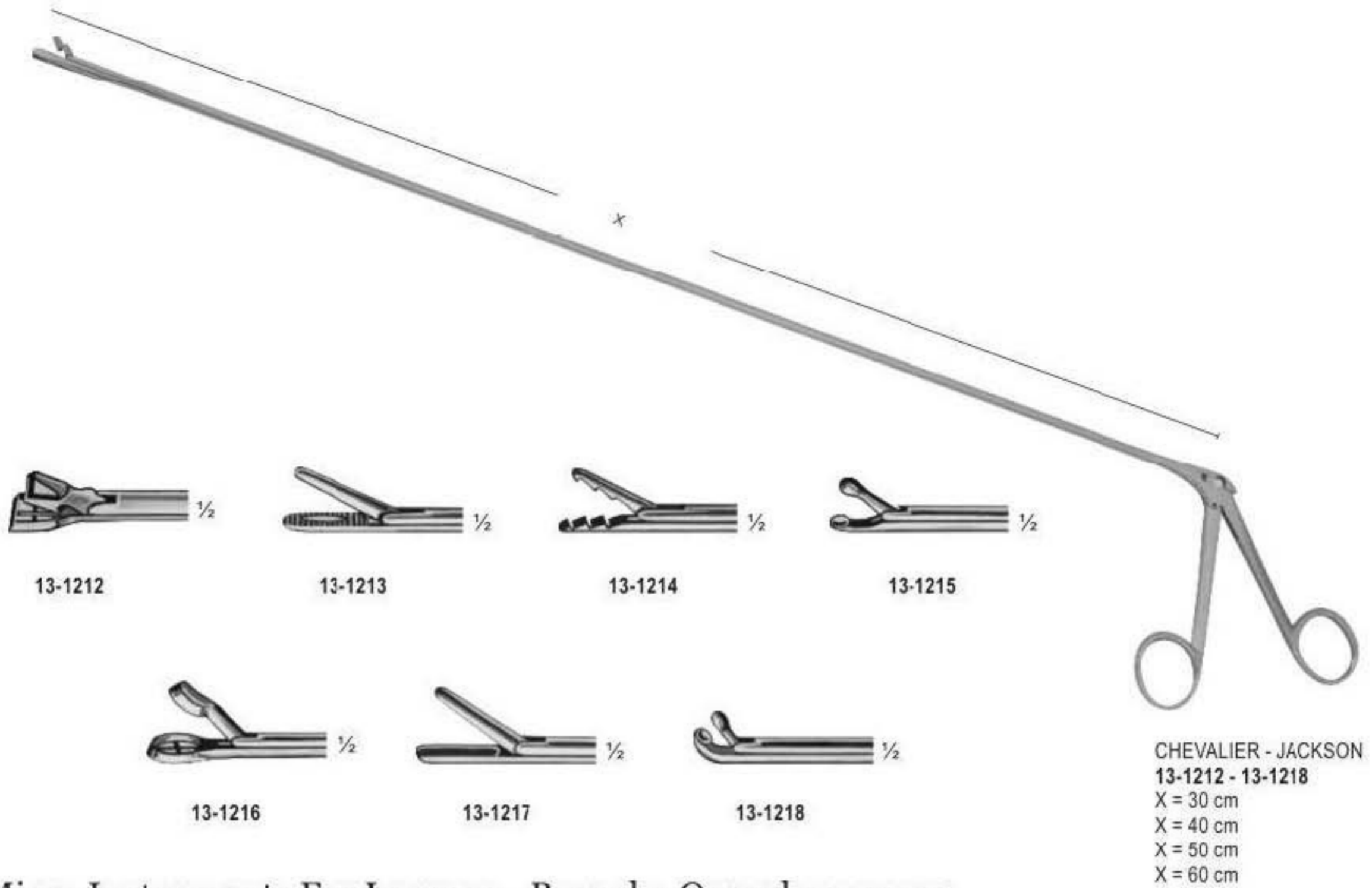

Micro Instruments For Laryngo - Broncho Oesophagoscopy

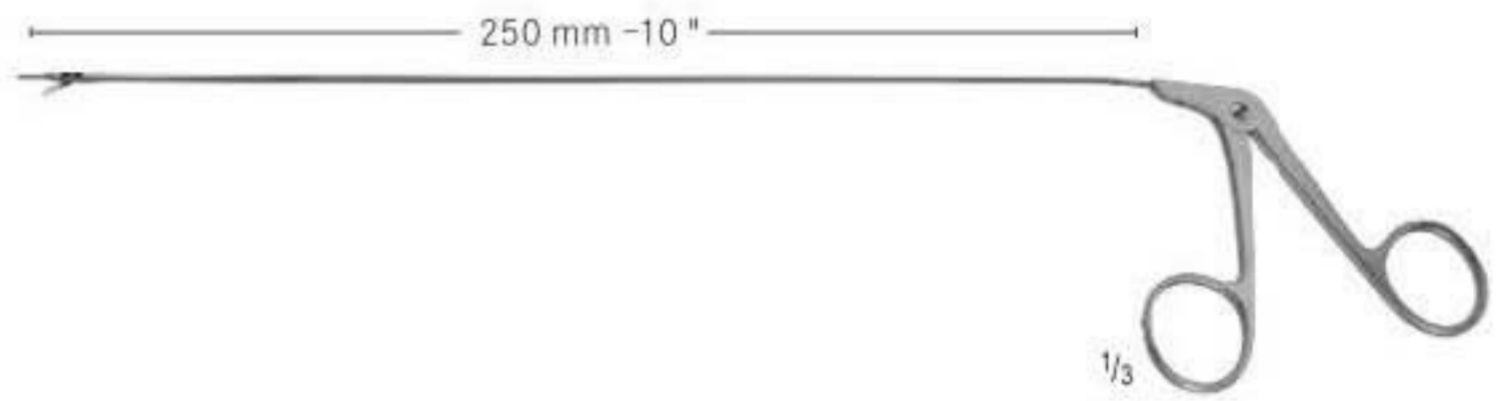

13-1226-00 - 13-1242-03

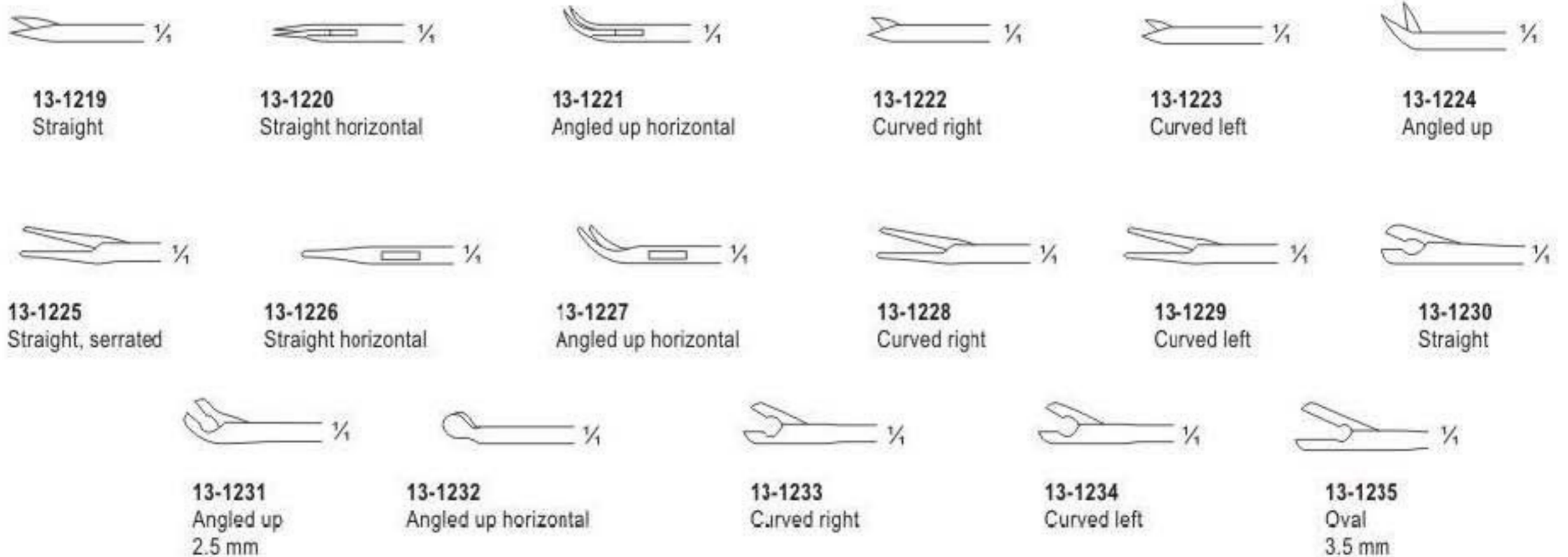

Blood Lancets & Laryngeal Mirrors

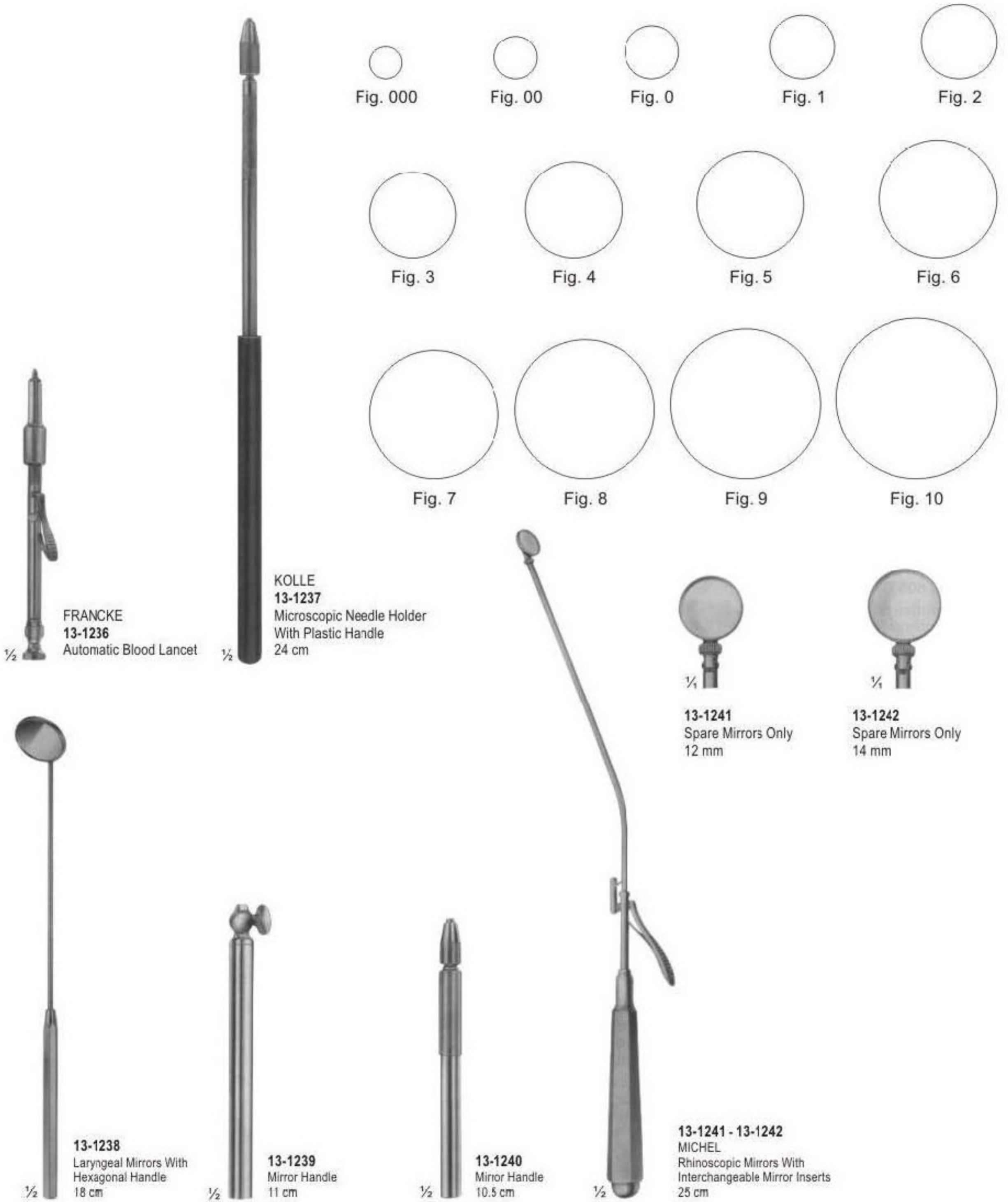

FRANCKE
13-1236
Automatic Blood Lancet

KOLLE
13-1237
Microscopic Needle Holder
With Plastic Handle
24 cm

Fig. 000 Fig. 00 Fig. 0 Fig. 1 Fig. 2
Fig. 3 Fig. 4 Fig. 5 Fig. 6
Fig. 7 Fig. 8 Fig. 9 Fig. 10

13-1241
Spare Mirrors Only
12 mm

13-1242
Spare Mirrors Only
14 mm

13-1238
Laryngeal Mirrors With
Hexagonal Handle
18 cm

13-1239
Mirror Handle
11 cm

13-1240
Mirror Handle
10.5 cm

13-1241 - 13-1242
MICHEL
Rhinoscopic Mirrors With
Interchangeable Mirror Inserts
25 cm

Page 293-326



- Vaginal Specula
- Endocervical Specula, Uterine Dilators
- Uterine Sounds, Uterine Depressor
- Uterine Elevators Forceps
- Uterine Tenaculum Forceps
- Obstetrics-pelvimeters
- Polypus & Ovum Forceps
- Myoma Instruments & Fistula Hooks
- Biopsy Forceps
- Uterine Scoops
- Uterine Curettes
- Placenta & Ovum Curettes
- Biopsy Curettes
- Vacuum Curettes
- Self-Retaining Retractors For Laminectomy & Other Operations
- Retractors For Cervical Spine
- Wound Spreaders, Self-Retaining
- Addominal Retractors



Vaginal Specula



CUSCO STANDARD
14-1001 - 14-1004
14-1001 80X24 mm
14-1002 80X32 mm
14-1003 90X36 mm
14-1004 110X37 mm



CUSCO
14-1005 - 14-1008
14-1005 80X24 mm
14-1006 80X32 mm
14-1007 90X36 mm
14-1008 110X37 mm



CUSCO
14-1009 - 14-1011
14-1009 80X24 mm
14-1010 80X32 mm
14-1011 115X36 mm



SEYFFERT
14-1012 - 14-1013
14-1012 100X24 mm
14-1013 110X32 mm
23 cm



SEMM
for children
and virgins
14-1014
18 cm

Vaginal Specula



COLLIN
for children
14-1015
53 x 10 mm



COLLIN
14-1016 - 14-1019

14-1016	100/90mm	28 mm
14-1017	100/90mm	32 mm
14-1018	105/95mm	35 mm
14-1019	115/105mm	40 mm
Total length/working length		width



COLLIN
for virgins
14-1020
95/85 x 18 mm



CUSCO
for virgins
14-1021
75 x 17 mm



CUSCO
for virgins
14-1022
75 x 17 mm



CUSCO
14-1023 - 14-1025

14-1023	92x23-25 mm
14-1024	100x25-27 mm
14-1025	110x27-30 mm

Vaginal Specula



GRAVES
14-1026 - 14-1028
14-1026 75X20 mm
14-1027 95X30 mm
14-1028 105X33 mm

1/2



14-1029 - 14-1030
14-1029 100X22 mm
14-1030 120X25 mm

1/2



BRIESKY
14-1031 - 14-1032
14-1031 72X25 mm / 77X30 mm
14-1032 75X30 mm / 92X38 mm
17 cm

1/2



1/2

BREISKY
14-1033 - 14-1036
14-1033 100X22 mm
14-1034 77 X30 mm
140 mm
14-1035 120X25 mm
14-1036 92 X38 mm
17 cm



1/2

SEIDL
14-1037 - 14-1039
14-1037 80X8 mm
14-1038 80X10 mm
14-1039 90X14 mm
For children and infants
17 cm



1/2

KRISTELLER
14-1040
70X15 mm
For children
17 cm



1/2

SIMS
14-1041 70X26 mm
75 X30 mm 125 mm
14-1042 75X30 mm
80 X85 mm 150 mm
14-1043 80X36 mm
90 X40 mm 175 mm

Vaginal Specula



KRISTELLER
14-1044 - 14-1048
 14-1044 110X18 mm
 14-1045 110X20 mm
 14-1046 110X27 mm
 14-1047 110X30 mm
 14-1048 110X36 mm
 22 cm

KRISTELLER
 Upper blades
14-1049 - 14-1052

KRISTELLER
 Lower blades
14-1053 - 14-1056

Vaginal Specula



Vaginal Specula



KRISTELLER
14-1067 - 14-1069
20.5 cm

JACKSON
14-1070 - 14-1072
17.5 cm

Vaginal Specula-for Children & Virgins / Vario Retractor



56 x 13 mm

$\frac{1}{2}$
BRAUN
14-1073
18 cm



60 x 10 mm

$\frac{1}{2}$
BRAUN
14-1074
18 cm



95 x 17 - 30 mm

$\frac{1}{2}$
MATHIEU
For children
and virgins
14-1075
21 cm



95 x 17-26 mm

$\frac{1}{2}$
MATHIEU
For children
and virgins fitting
14-1076
21 cm



Handle with cold light
carrier for upper blades
14-1077
21 cm

Vaginal Specula-for Children And Virgins

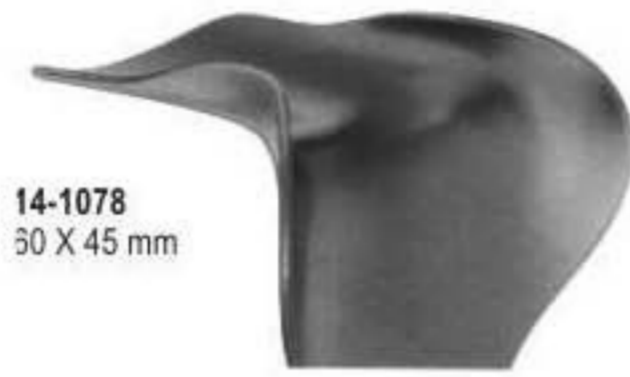

14-1078
30 X 45 mm

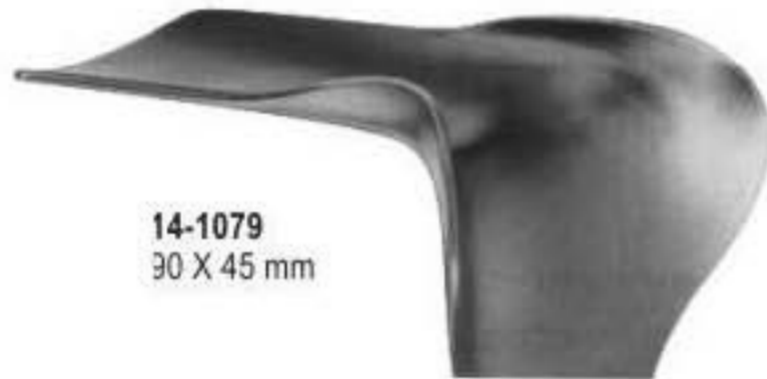

14-1079
30 X 45 mm



14-1080
112 X 45 mm



¼



½

DOYEN
14-1078 - 14-1080
23.5 cm

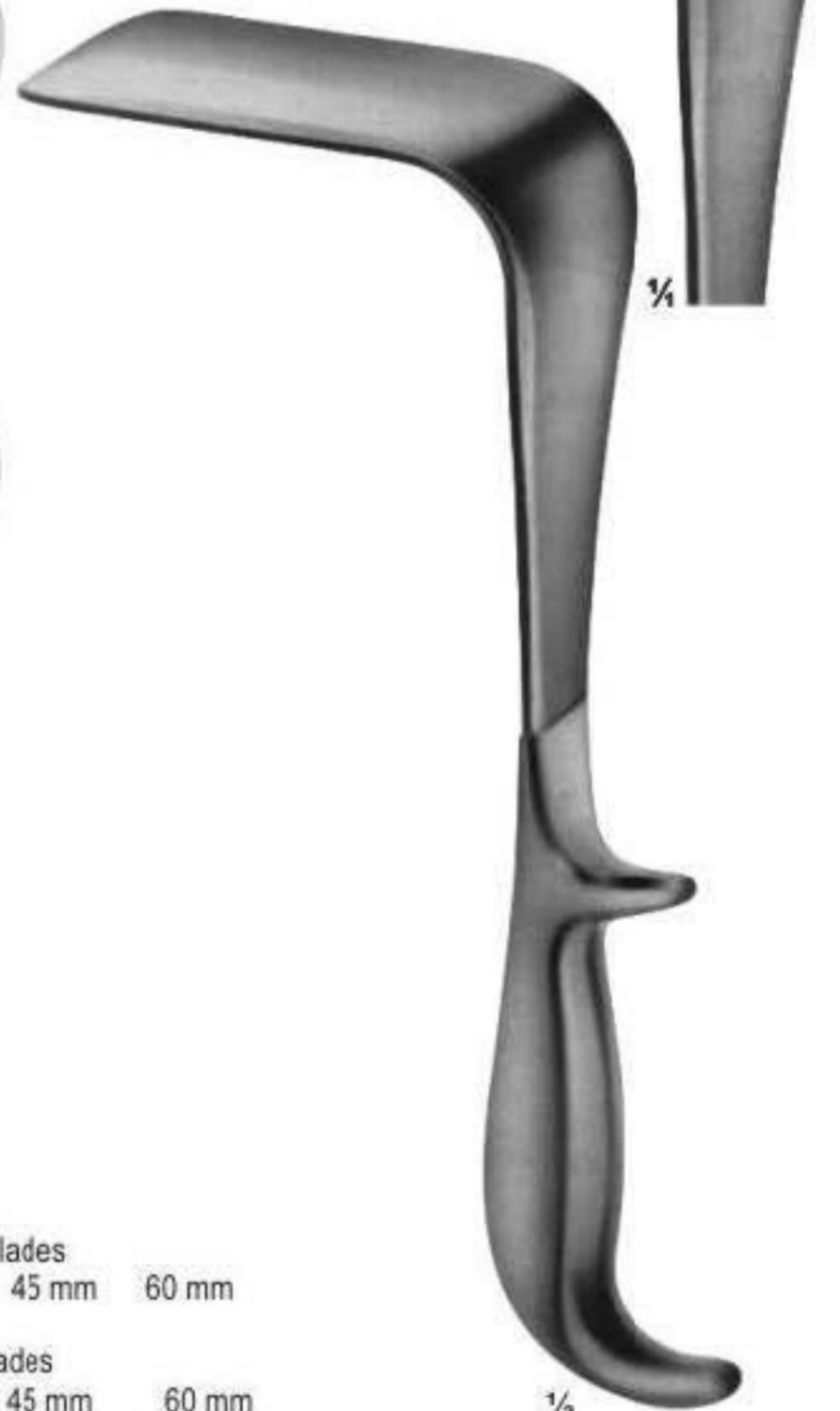

½

14-1081 - 14-1091

Length of blades	Width of blades		
	35 mm	45 mm	60 mm
60 mm			
90 mm	14-1081	14-1084	14-1088
120 mm	14-1082	14-1085	14-1089
160 mm	14-1083	14-1086	14-1090
		14-1087	14-1091

Vaginal Speculas



14-1092
80 X 30



14-1093
85 X 35



14-1094
85 X 40



14-1095
55 X 40 - 60 mm



14-1096
70 X 45 - 70 mm



14-1097
80 X 30 mm



14-1101
65 X 30 mm



14-1098
85 X 33 mm



14-1102
75 X 35 mm



14-1099
100 X 38 mm



14-1103
85 X 35 mm



14-1100
110 X 42 mm



14-1104
95 X 35 mm



SCHERBACK
14-1092 - 14-1096
Set consisting of:
handle
weight
5 blades

1/3



SCHERBACK
14-1097 - 14-1104
Set consisting of:
2 handle
8 blades

1/3

Vaginal Specula / Retractors



BREISKY
WIENER MODELL/
VIENNA PATTERN
14-1105 - 14-1109
14-1105 100 X 20 mm
14-1106 100 X 25 mm
14-1107 100 X 30 mm
14-1108 100 X 35 mm
14-1109 100 X 40 mm
30 cm



BREISKY
WIENER MODELL/
VIENNA PATTERN
14-1110 - 14-1114
14-1110 130 X 20 mm
14-1111 130 X 25 mm
14-1112 130 X 30 mm
14-1113 130 X 35 mm
14-1114 130 X 40 mm
32 cm



WEISSBARTH
14-1115 - 14-1116
14-1115 80 X 28 mm
14-1116 85 X 42 mm
21 cm



DOYEN
14-1117
lateral speculum
80 x 30 mm
25 cm

Vaginal & Wound Retractor



1/2



1/2

SIMON
14-1118
115 X 22 mm
27.5 cm



1/2

AUVARD
14-1119
65 X 38 mm - 28 mm
1530 kg
with fixed weight
23 cm



1/2

AUVARD
14-1120 - 14-1121
14-1120 75 X 42 mm
(40 mm)
14-1121 105 X 43 mm
(40 mm)
with detachable wight
23 cm



1/2

MARTIN
14-1122
with hook shaped
handle for hanging
in weights
27 cm

Special Retractors



JOLL (FRIEDMAN)
Thyroid- and Vaginal Retractor
14-1123
15.5 cm



O'SULLIVAN-O'CONNOR
14-1124 - 14-1126

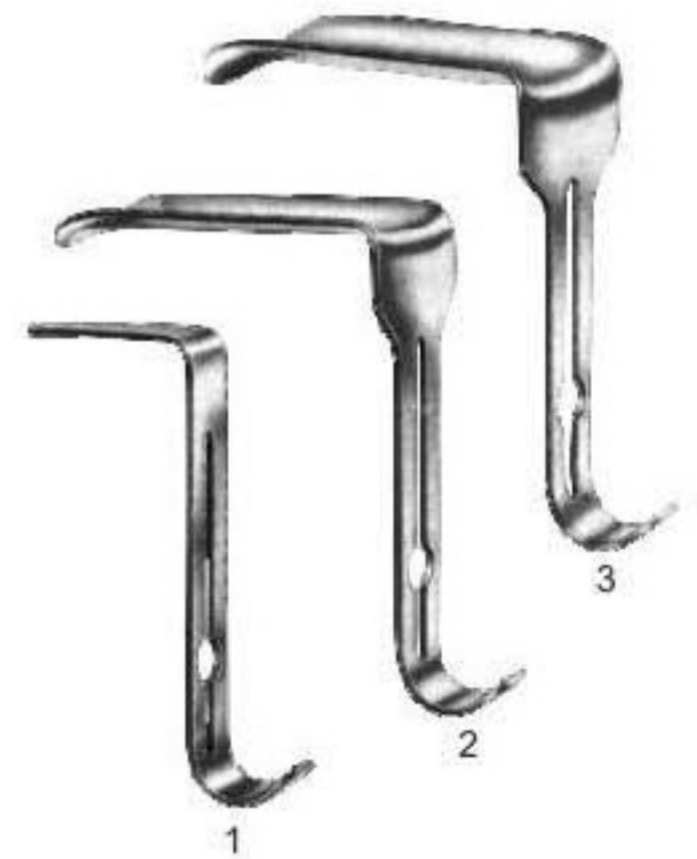

Blades for
Fig. 1 = **14-1124** 45 X 17 mm
Fig. 2 = **14-1125** 90 X 37 mm
Fig. 3 = **14-1126** 90 X 45 mm

Endocervical Specula, Uterine Dilators

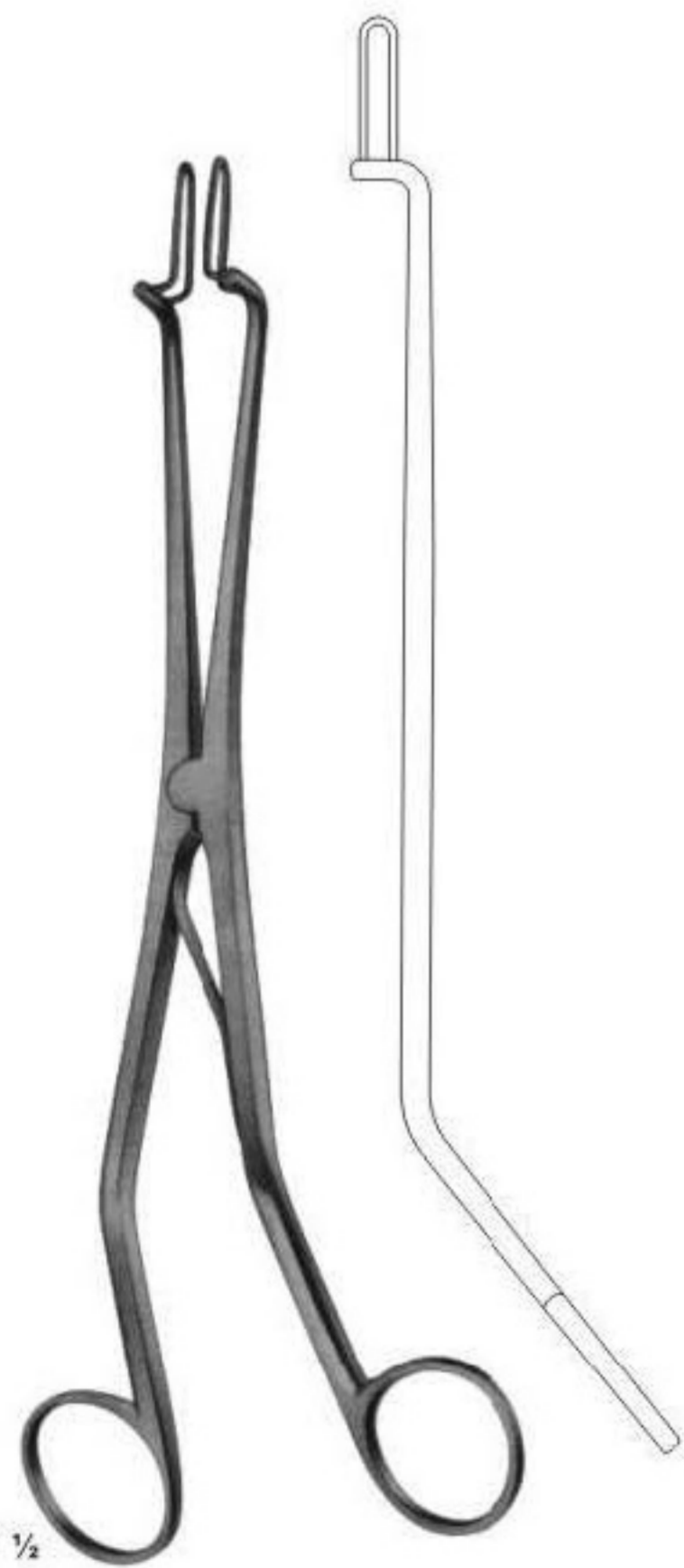

KOGAN
14-1127
Endospecula for cervix
and urethra, without ratchet
24 cm



KOGAN
14-1128
Endospecula for cervix
and urethra, with
scale-ratchet and fixing screws
24 cm



GOODELL
14-1129
34 cm

Uterine Dilators



1/2

HEGAR
14-1130 - 14-1172
18 cm

14-1130	1 mm	14-1152	2.5 mm
14-1131	2 mm	14-1153	3.5 mm
14-1132	3 mm	14-1154	4.5 mm
14-1133	4 mm	14-1155	5.5 mm
14-1134	5 mm	14-1156	6.5 mm
14-1135	6 mm	14-1157	7.5 mm
14-1136	7 mm	14-1158	8.5 mm
14-1137	8 mm	14-1159	9.5 mm
14-1138	9 mm	14-1160	10.5 mm
14-1139	10 mm	14-1161	11.5 mm
14-1140	11 mm	14-1162	12.5 mm
14-1141	12 mm	14-1163	13.5 mm
14-1142	13 mm	14-1164	14.5 mm
14-1143	14 mm	14-1165	15.5 mm
14-1144	15 mm	14-1166	16.5 mm
14-1145	16 mm	14-1167	17.5 mm
14-1146	17 mm	14-1168	23 mm
14-1147	18 mm	14-1169	24 mm
14-1148	19 mm	14-1170	25 mm
14-1149	20 mm	14-1171	26 mm
14-1150	21 mm	14-1172	1.5 mm
14-1151	22 mm		



HEGAR DILATOR
14-1173
Uterine dilator set, in canvas
roll with 14 dilators (4 mm - 17 mm)

HEGAR DILATOR
14-1174
Uterine dilator set, in canvas
roll with 26 dilators (1 mm - 26 mm)



1/2

HEGAR
14-1175 - 14-1187
20 cm

14-1175	1/2 mm
14-1176	3/4 mm
14-1177	5/6 mm
14-1178	7/8 mm
14-1179	9/10 mm
14-1180	11/12 mm
14-1181	13/14 mm
14-1182	15/16 mm
14-1183	17/18 mm
14-1184	19/20 mm
14-1185	21/22 mm
14-1186	23/24 mm
14-1187	25/26 mm



1/4

HEGAR
14-1188
Uterine dilator set, in canvas
roll with 8 dilator (3/4 mm - 17/18 mm).

Uterine Dilators

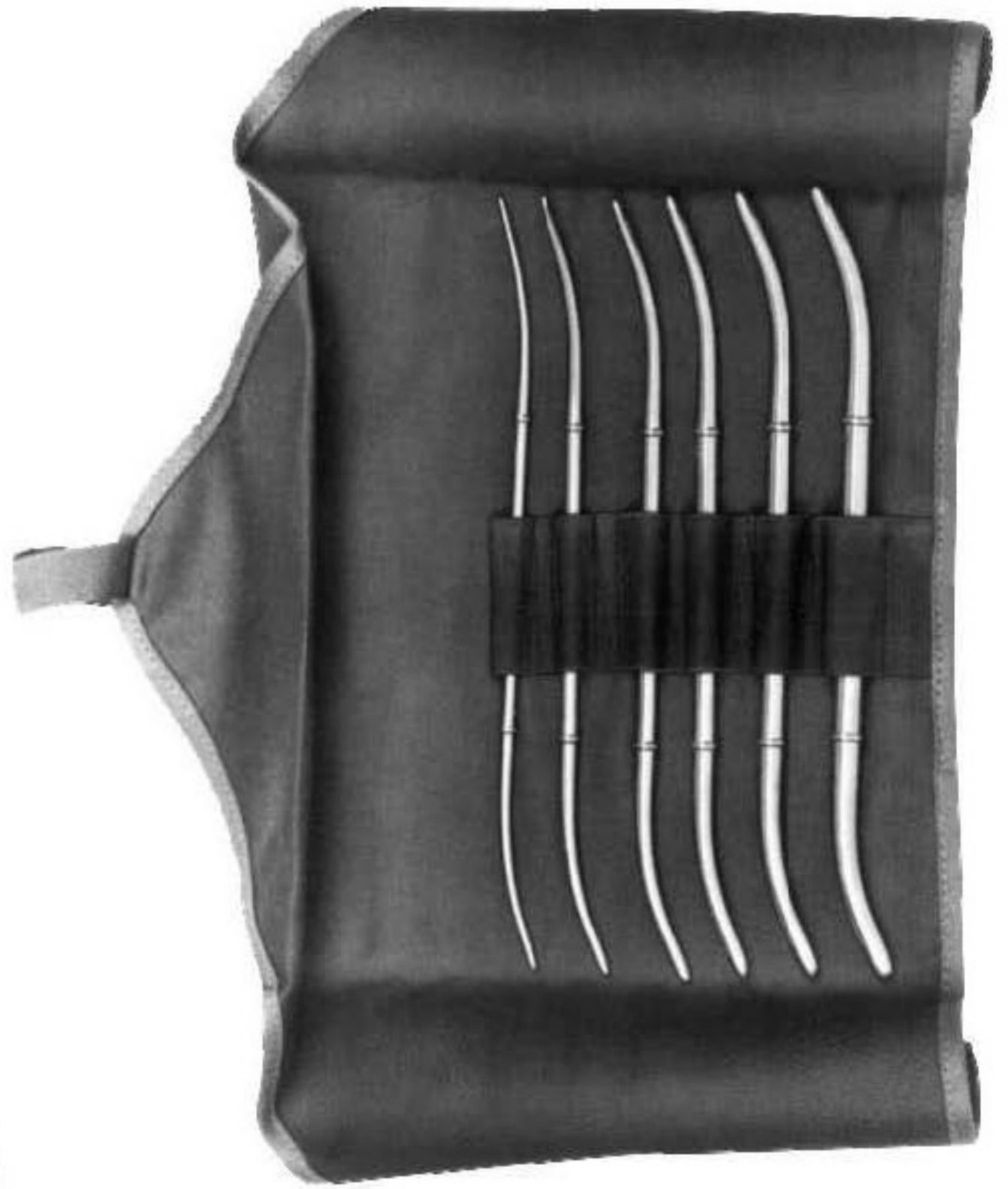

HANK
Fig. 9.10 **14-1189** 4.5/5 mm
Fig. 11.12 **14-1190** 5.5/6 mm
Fig. 13.14 **14-1191** 6.5/7 mm
Fig. 15.16 **14-1192** 7.5/8 mm
Fig. 17.18 **14-1193** 8.5/9 mm
Fig. 19.20 **14-1194** 9.5/10 mm

HANK
14-1189 - 14-1194

Uterine Sounds, Uterine Depressor

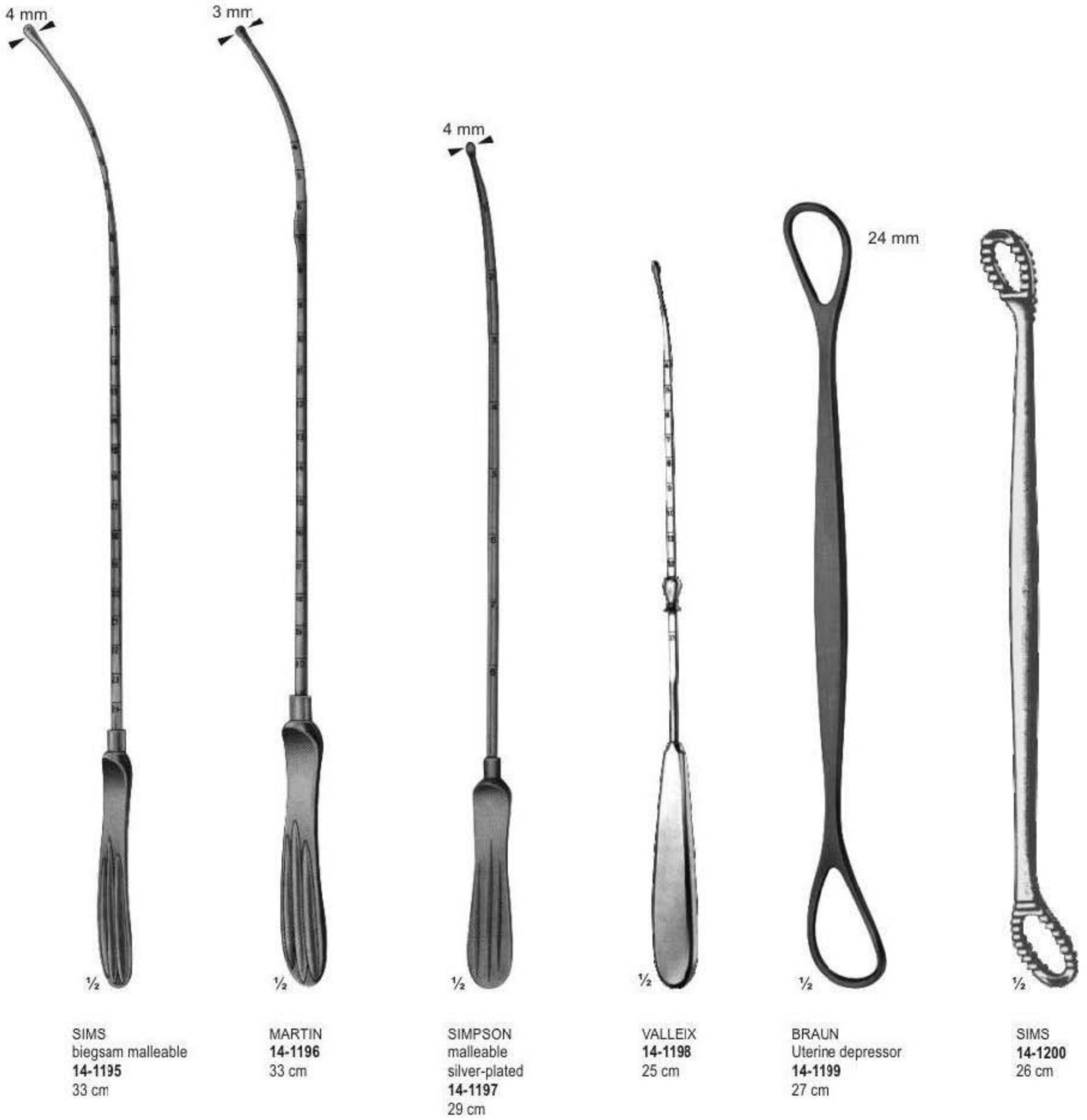

Uterine Elevating Forceps



DARTIGUES
14-1201
25.5 cm



SOMER
14-1202
23.5 cm



STRASSMANN
14-1203
26 cm



COLLIN
14-1204
25 cm



COLLIN
14-1205
28.5 cm

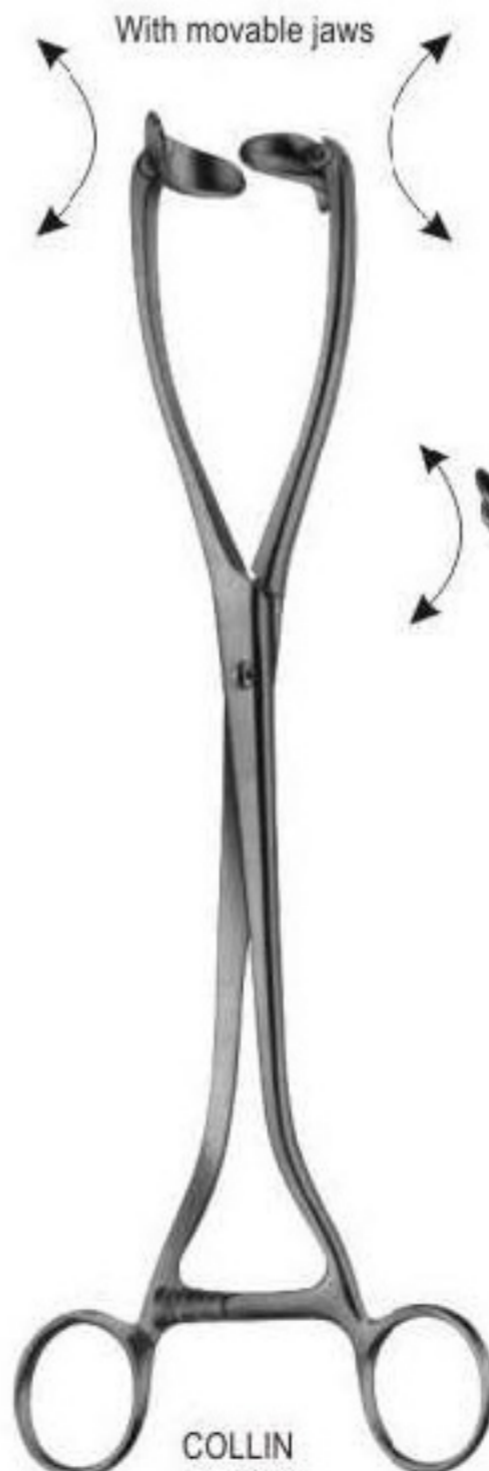

COLLIN
14-1206
26.5 cm



14-1207
26 cm

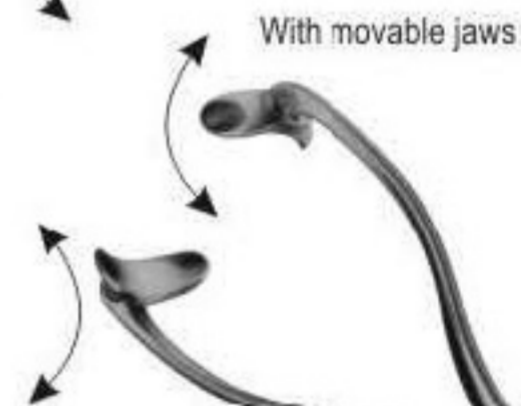

Uterine Tenaculum Forceps



BRAUN
slender type
14-1208
26 cm

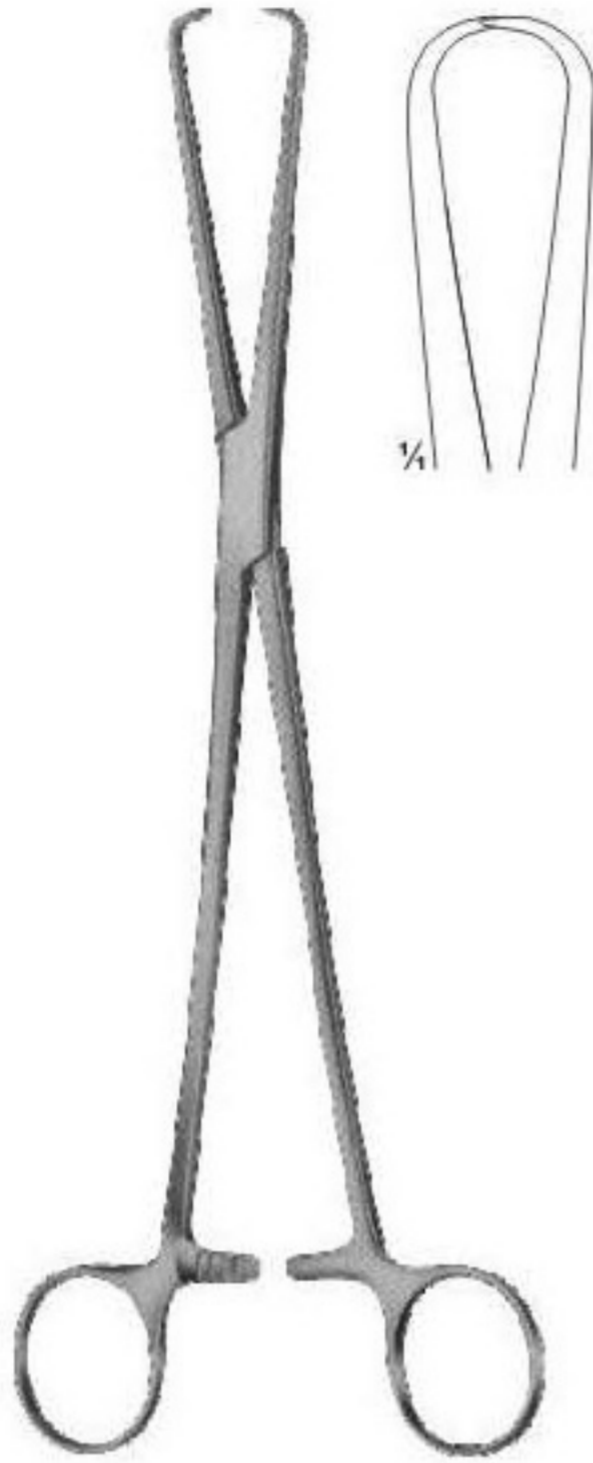

SCHROEDER
14-1209
25 cm



BEACHAM HOOK
14-1210
26 cm



POZZI
heavy type
14-1211
25.5 cm

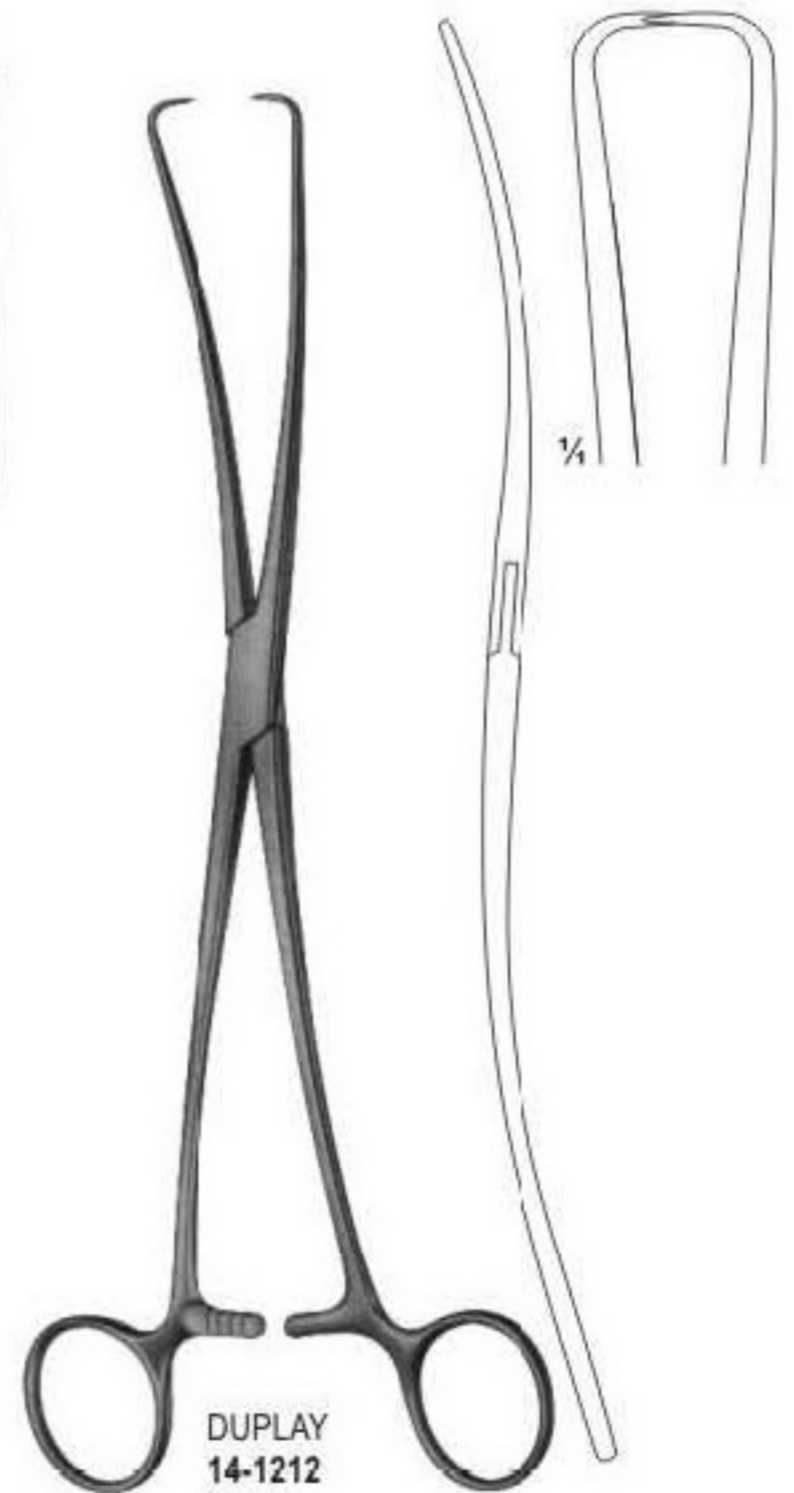

DUPLAY
14-1212
25 cm

Uterine Tenaculum Forceps

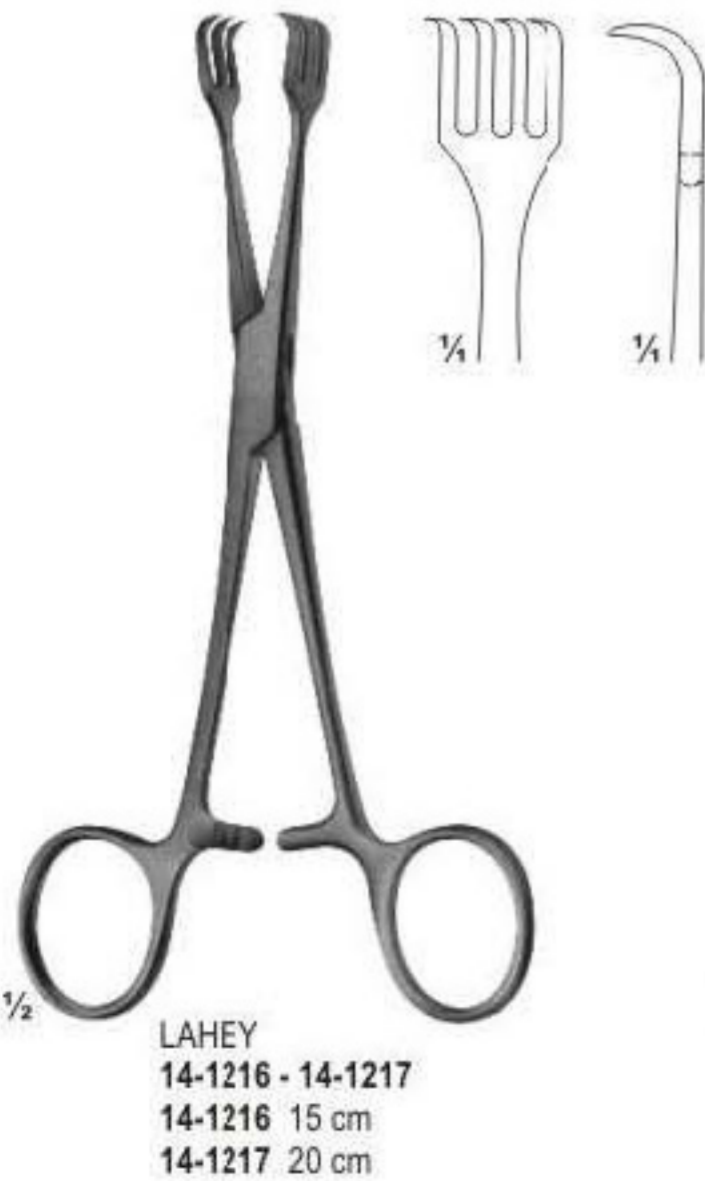
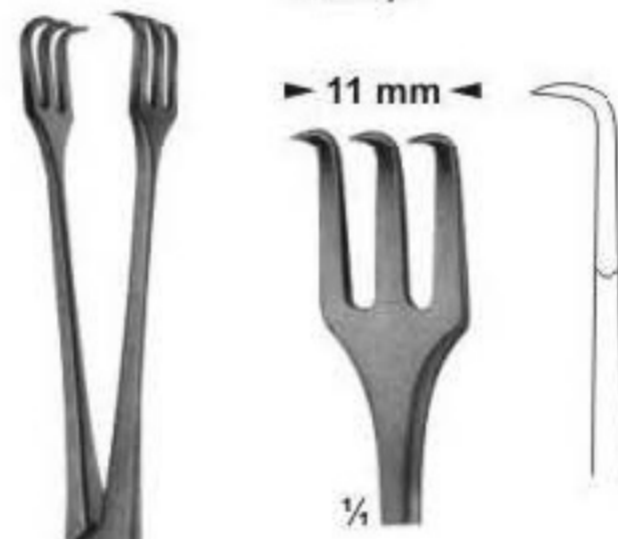
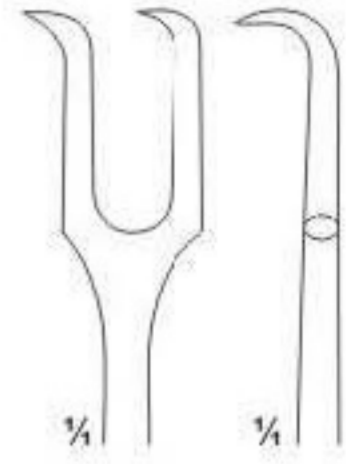

Uterine Tenaculum Forceps And Obstetrics-pelvimeters



KUSTNER
14-1220
25 cm



SKENE
14-1221
24 cm



TEALE
14-1222
23 cm

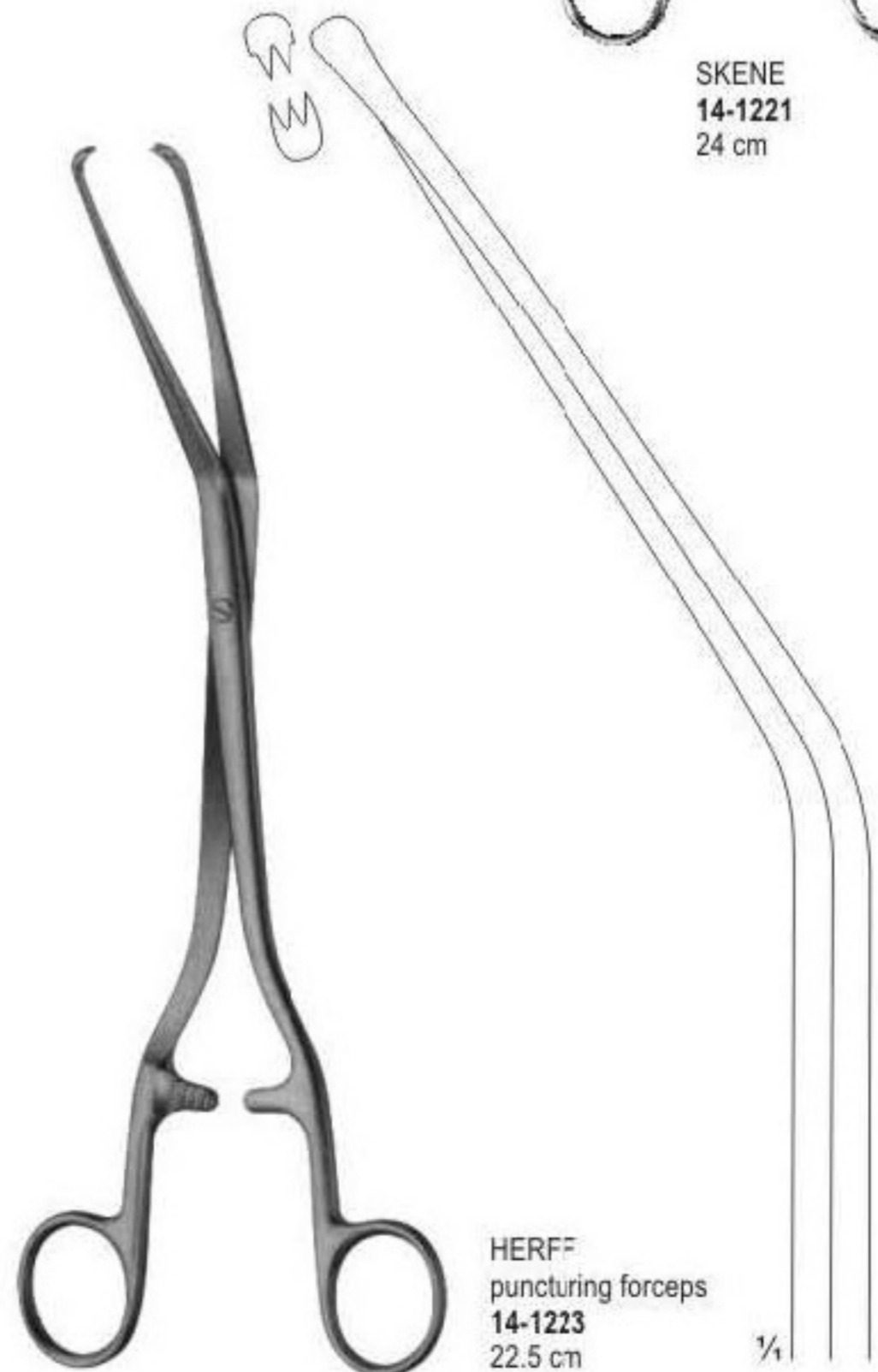

HERFF
puncturing forceps
14-1223
22.5 cm

Uterine Tenaculum Forceps And Obstetrics-pelvimeters



KUSTNER
14-1220
25 cm



SKENE
14-1221
24 cm



TEALE
14-1222
23 cm

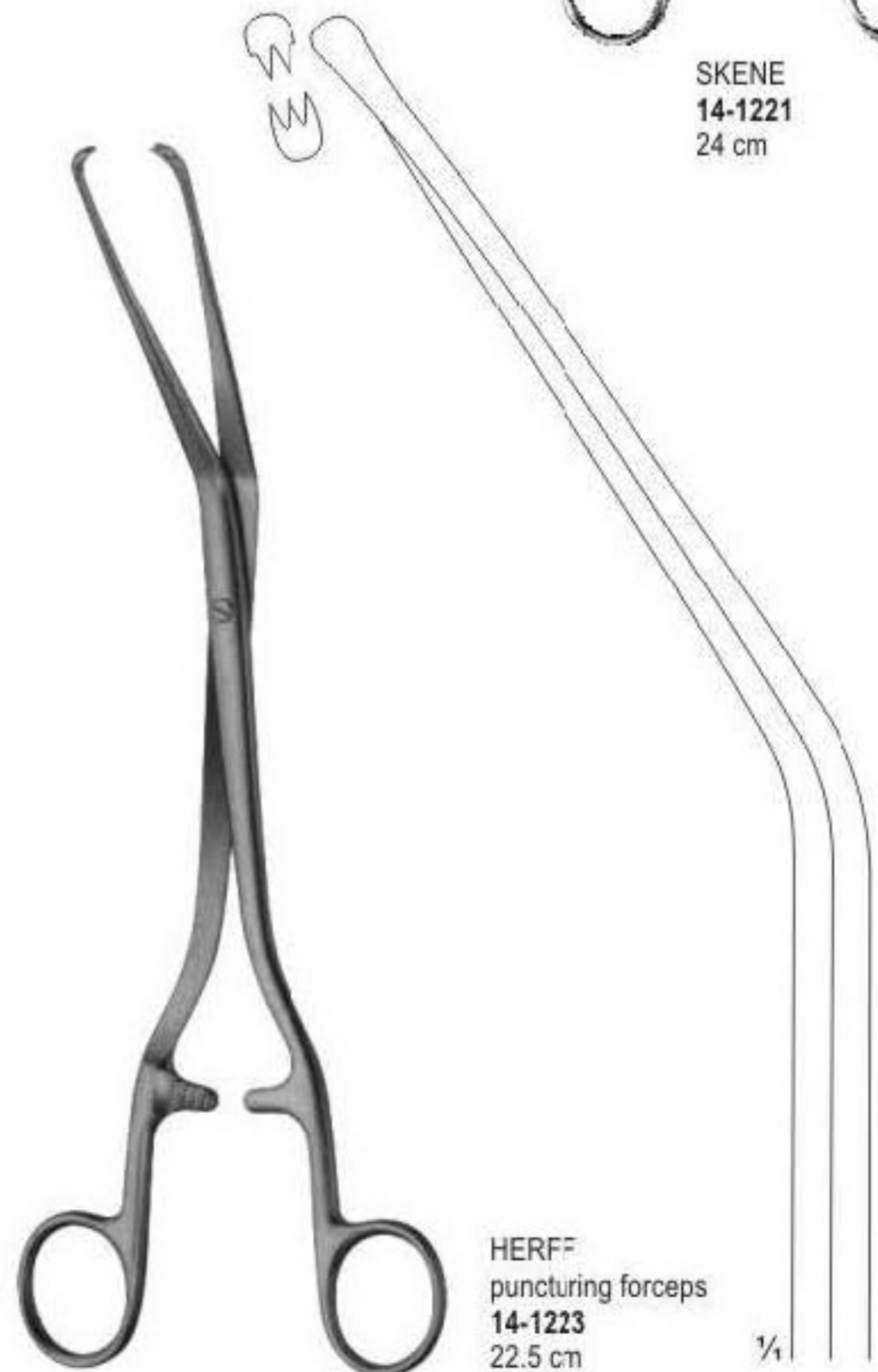

HERFF
puncturing forceps
14-1223
22.5 cm

Polypus-and Ovum Forceps



HEYWOOD-SMITH
14-1234
20 cm

HEYWOOD-SMITH
14-1235
25 cm

NOTO
14-1236
28 cm

KELLY
14-1237
32 cm

Myoma Instruments And Fistula Hooks



SEGOND
Myomatome
14-1238
27 cm



DOYEN
Myoma screw
14-1239
15 cm



DOYEN
Myoma screw
14-1240
19 cm



14-1241 **14-1242** **14-1243**

NEUBUSER
Tubal seizing forceps
14-1241 - 14-1243
20 cm

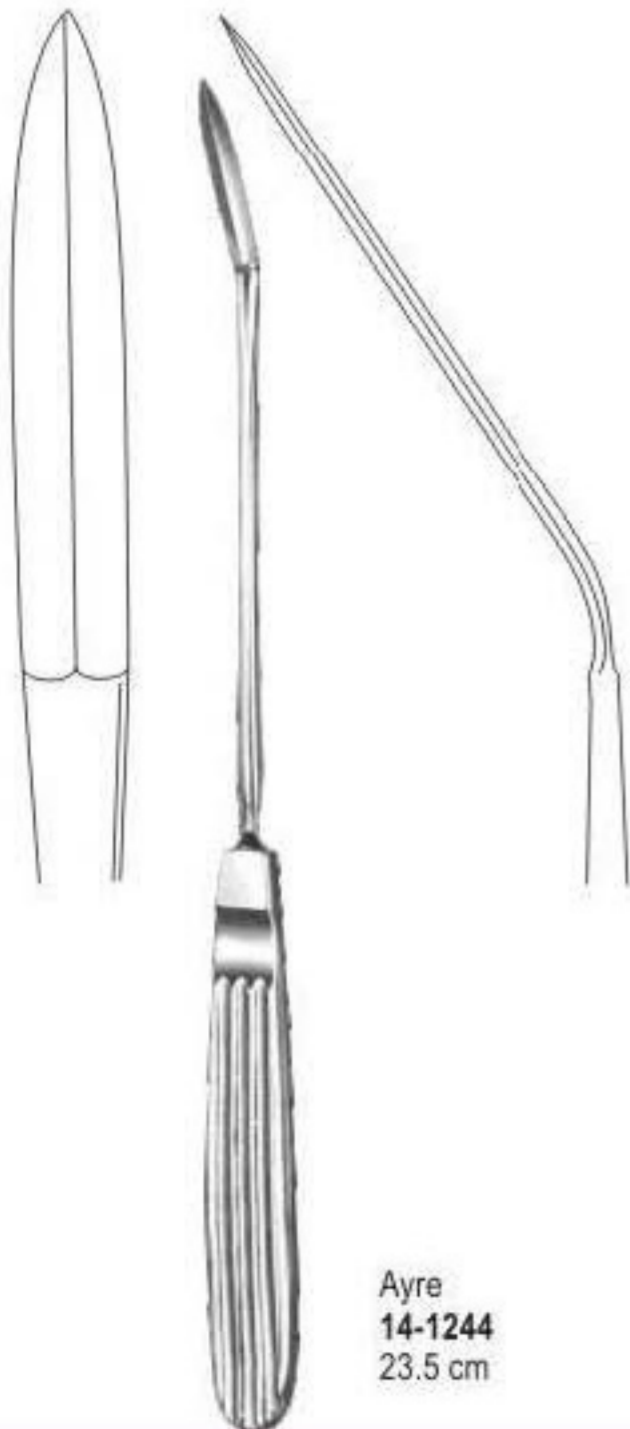

Ayre
14-1244
23.5 cm



EMMETT
Fig. 3
14-1245
23 cm



SIMON
14-1246
21.5 cm

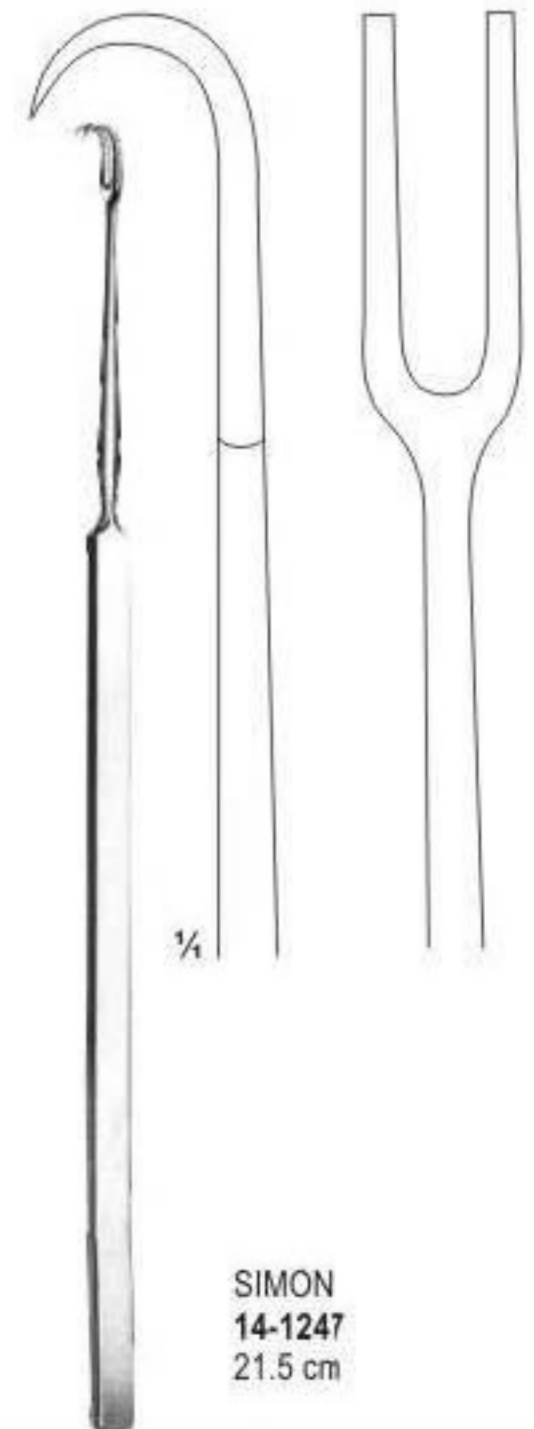

SIMON
14-1247
21.5 cm

Biopsy Forceps

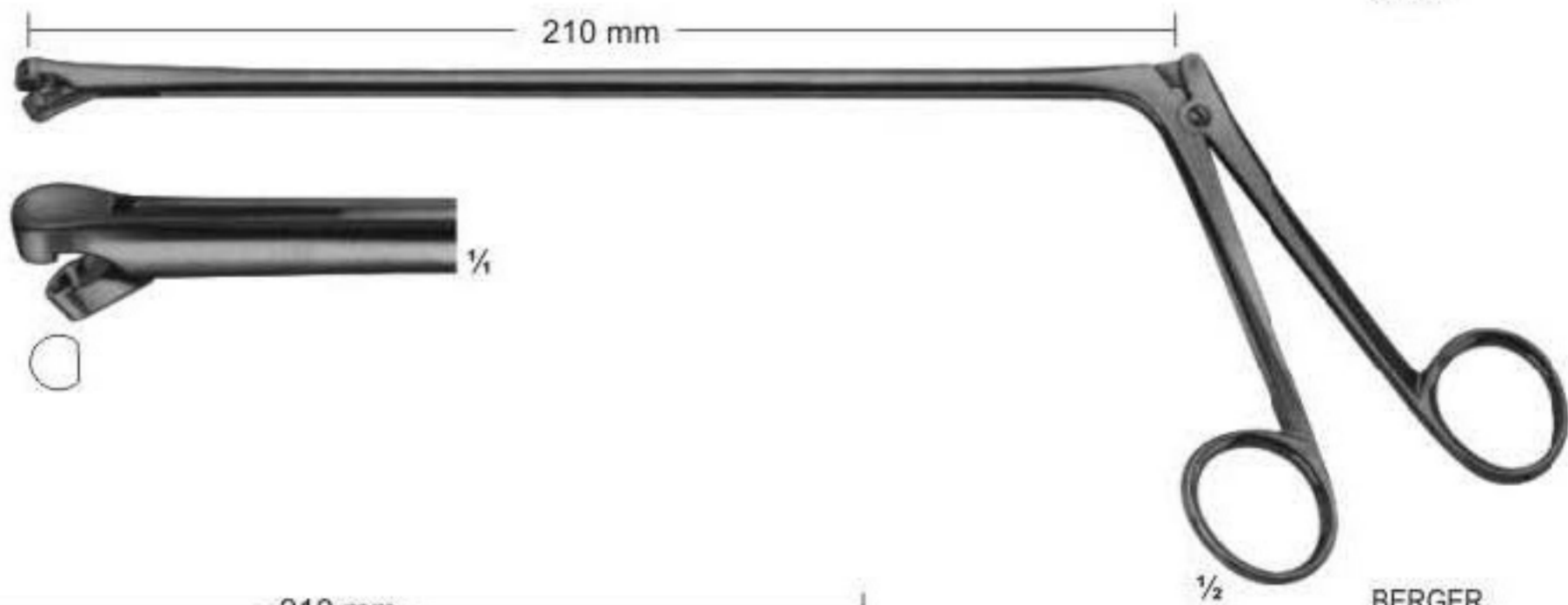
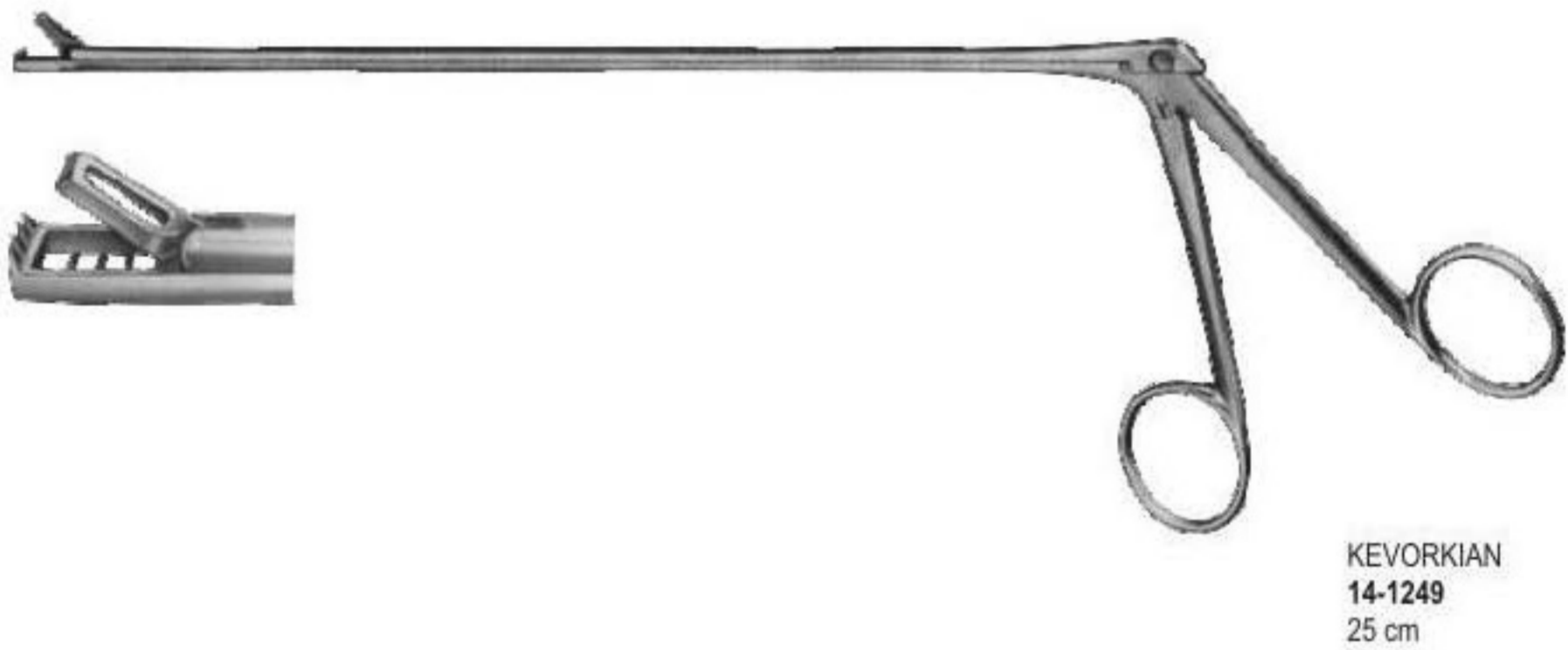
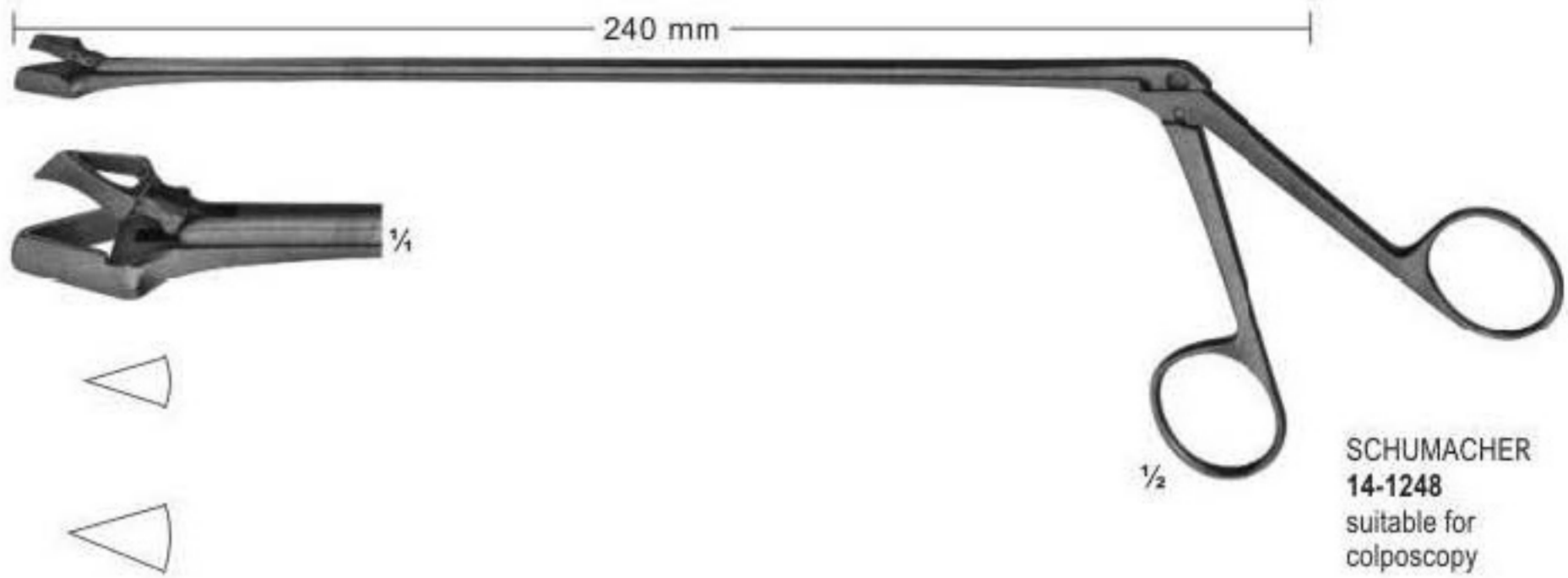

Biopsy Forceps

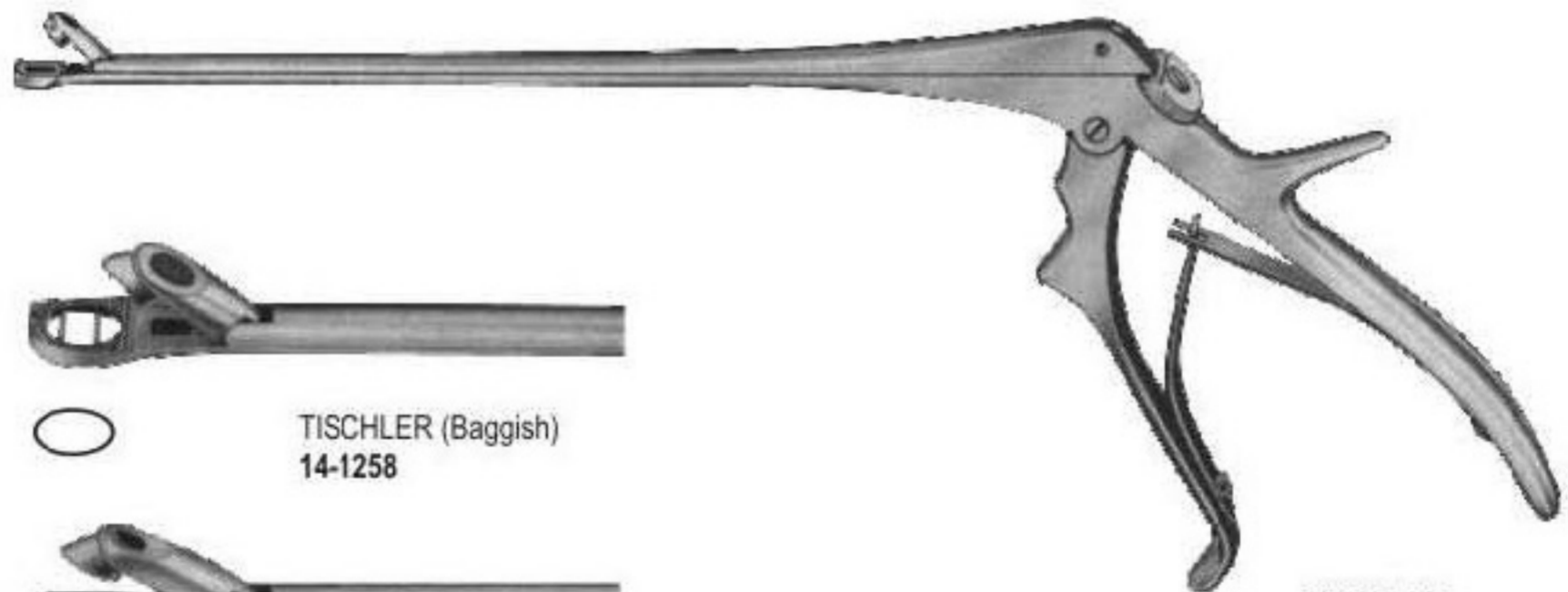

Biopsy Forceps



1/2
FAURE
14-1260
21 cm

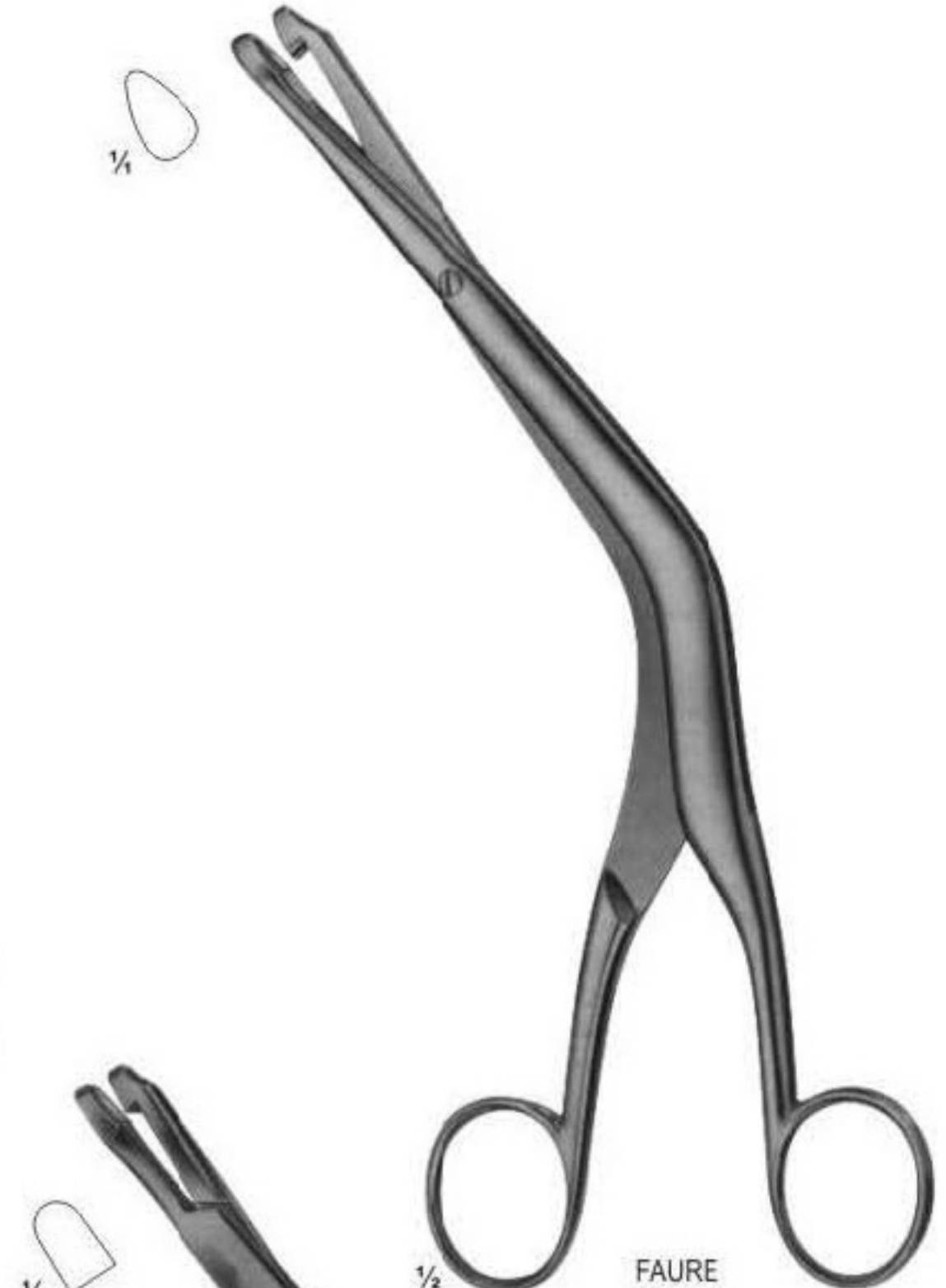

1/2
FAURE
14-1261
24 cm

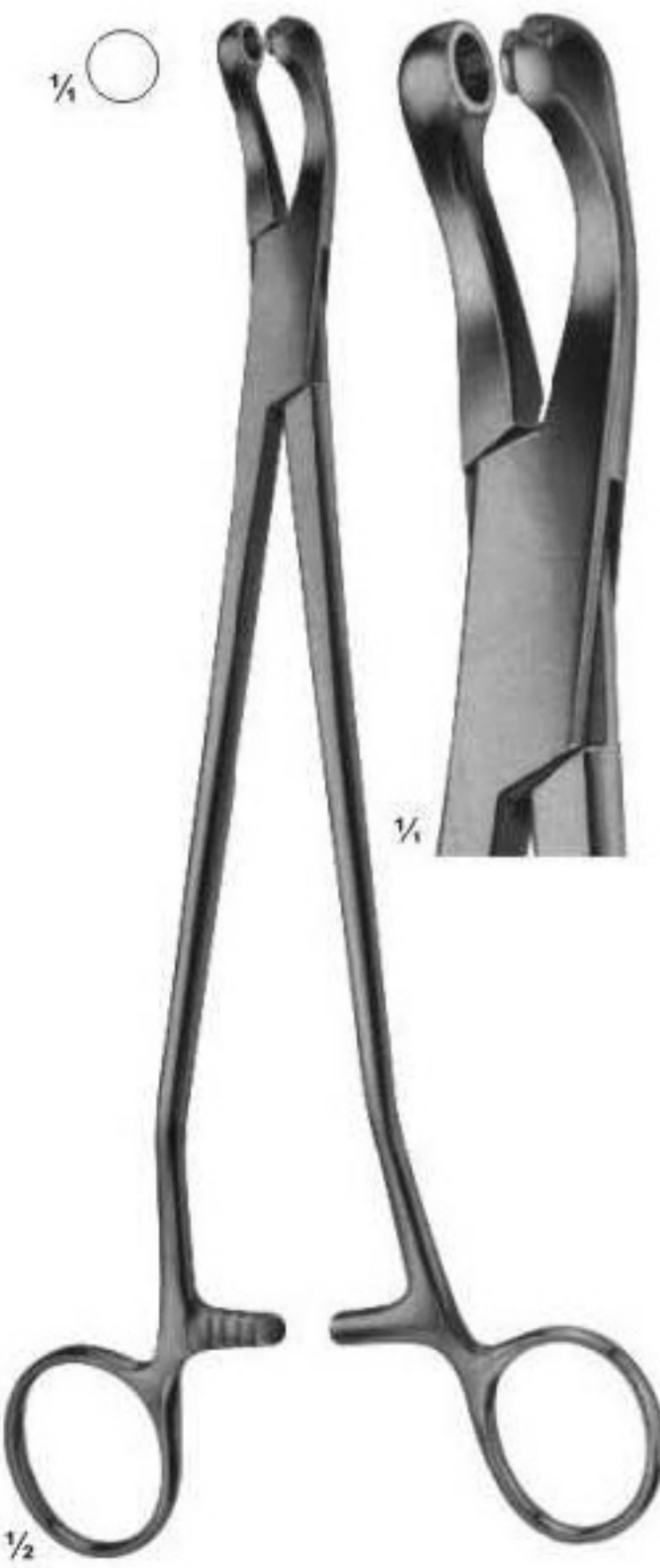

1/2
THOMS-GAYLOR
14-1262
24 cm



1/2
SCHUBERT
14-1263
26 cm

Biopsy Forceps

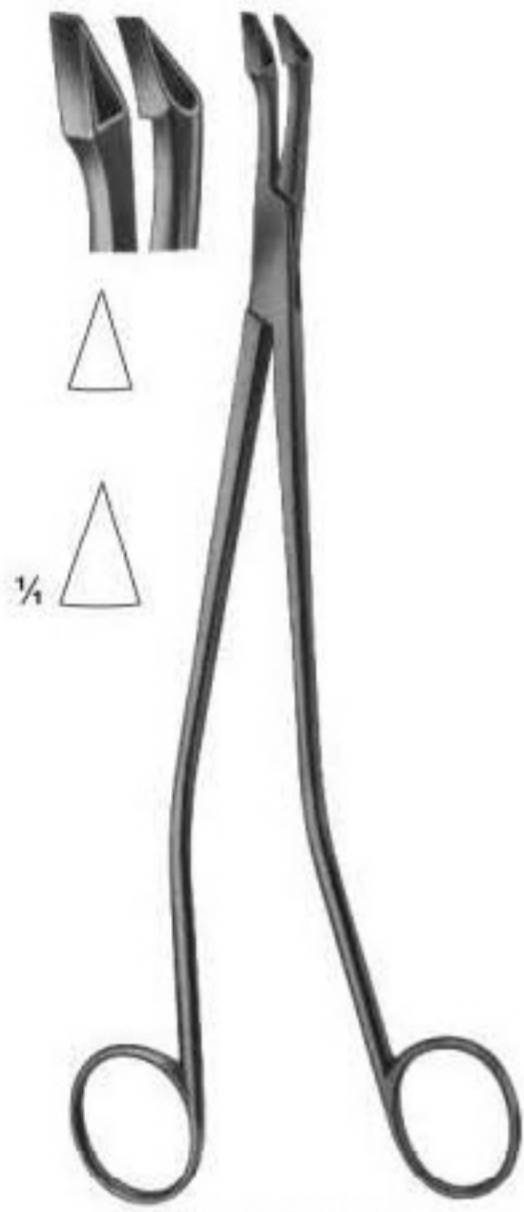

SCHUMACHER
14-1264
24 cm



GELLHORN
14-1265
24 cm
8.6 mm



VAN DOREN
14-1266
25.5 cm
4.9 mm



VAN DOREN
14-1267
27 cm
5.5 mm

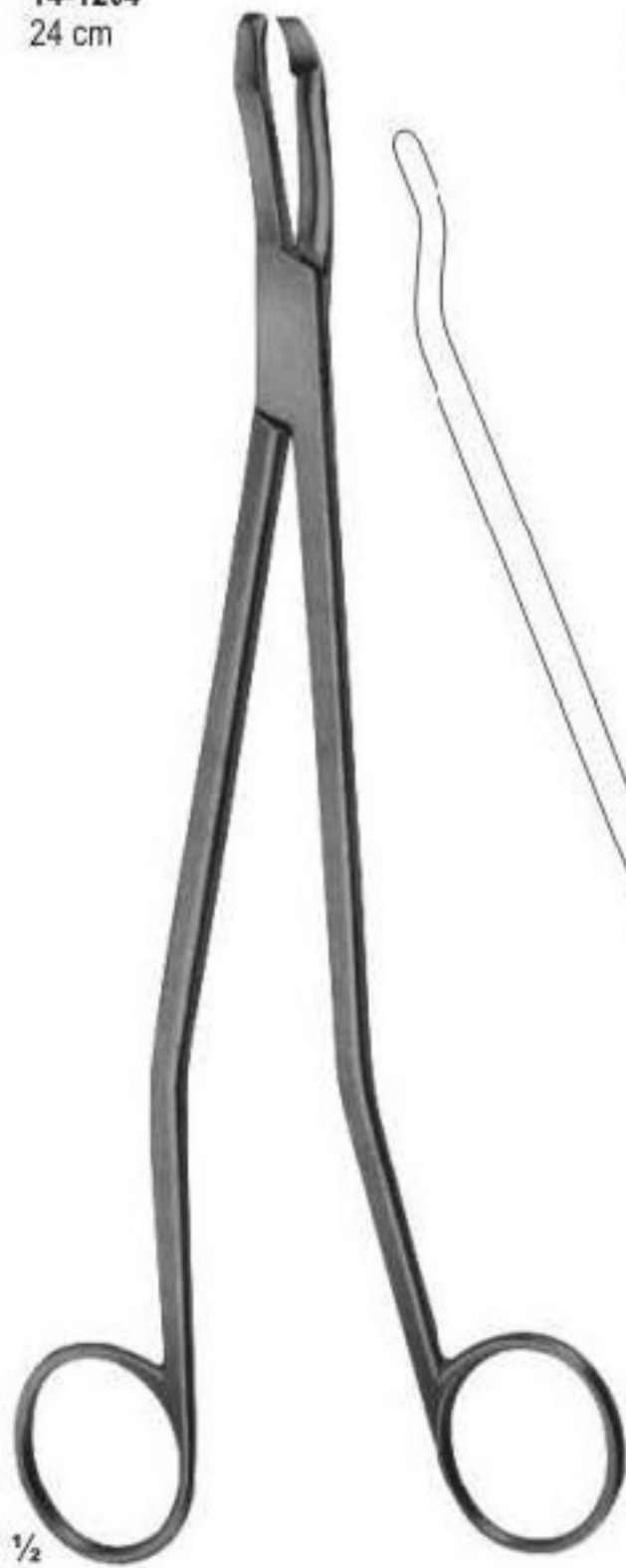

SEIDL DBP
14-1268 - 14-1270
Biopsy forceps, bayonet shaped
for portio, vagina and vulva
24 cm



14-1268
2.0 mm



14-1269
2.4 mm



14-1270
2.4 mm

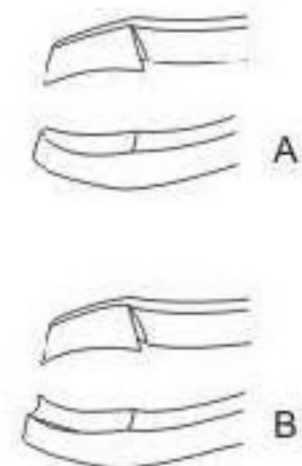

Biopsy Forceps



TOWNSEND
14-1271 - 14-1288
Handle Only



TOWNSEND-TISCHLER
14-1271
360°
complete

14-1272
tip only



TOWNSEND-TISCHLER
14-1273
360°
complete

14-1274
tip only



TOWNSEND-TISCHLER
14-1275
360°
complete

14-1276
tip only



TOWNSEND-MINI
14-1277
360°
complete

14-1278
tip only



TOWNSEND-MINI
14-1279
360°
complete

14-1280
tip only



TOWNSEND-MINI
14-1281
360°
complete

14-1282
tip only



TOWNSEND-BURKE
14-1283
360°
complete

14-1284
tip only



TOWNSEND-KEVORKIAN
14-1285
360°
complete

14-1286
tip only



TOWNSEND-KRAUSE
14-1287
360°
complete

14-1288
tip only

Uterine Scoops



Fig. 1
14-1289
23 cm
10X7 mm

Fig. 2
14-1290
23.5 cm
12X8 mm

Fig. 3
14-1291
24 cm
13X10 mm

Fig. 4
14-1292
24 cm
16X12 mm

Fig. 5
14-1293
24 cm
18X13 mm

Fig. 6
14-1294
24 cm
20X15 mm

SIMON
14-1289 - 14-1294

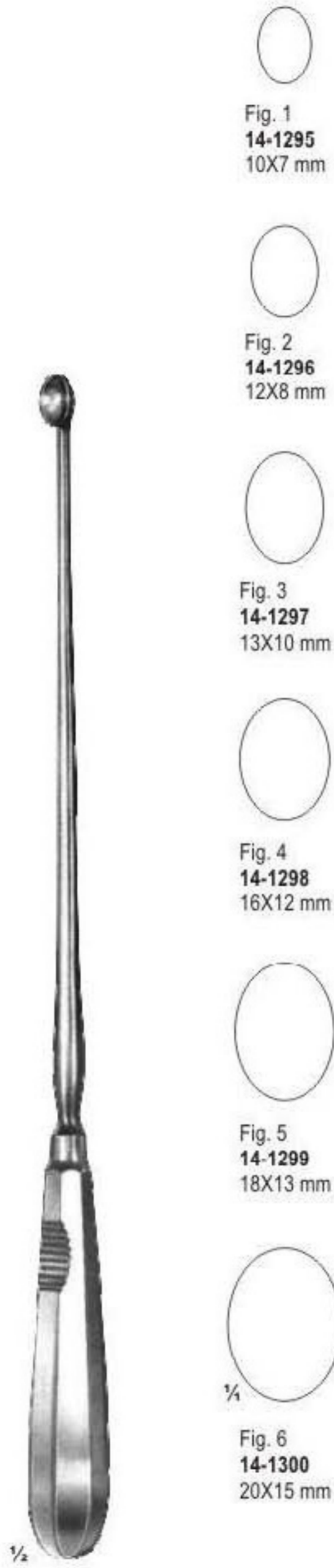

Fig. 1
14-1295
10X7 mm

Fig. 2
14-1296
12X8 mm

Fig. 3
14-1297
13X10 mm

Fig. 4
14-1298
16X12 mm

Fig. 5
14-1299
18X13 mm

Fig. 6
14-1300
20X15 mm

SIMON
14-1295 - 14-1300

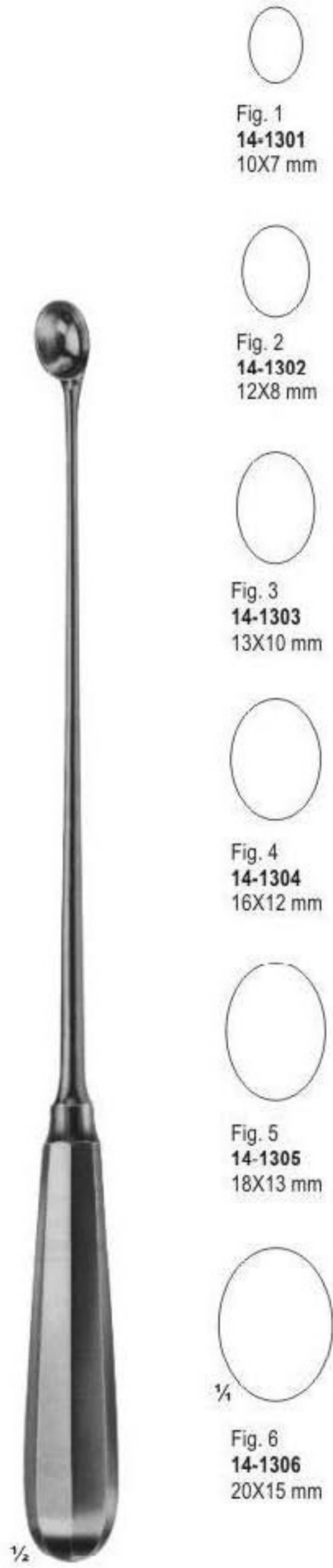

Fig. 1
14-1301
10X7 mm

Fig. 2
14-1302
12X8 mm

Fig. 3
14-1303
13X10 mm

Fig. 4
14-1304
16X12 mm

Fig. 5
14-1305
18X13 mm

Fig. 6
14-1306
20X15 mm

SCHRODER
14-1301 - 14-1306



blunt

BLAKE
14-1307
27.5 cm

Uterine Curettes



Sharp Rigit

- Fig. 00 14-1308 5 mm
- Fig. 0 14-1309 6 mm
- Fig. 1 14-1310 7 mm
- Fig. 2 14-1311 8 mm
- Fig. 3 14-1312 9 mm
- Fig. 4 14-1313 11 mm
- Fig. 5 14-1314 12 mm
- Fig. 6 14-1315 14 mm
- Fig. 7 14-1316 15 mm
- Fig. 8 14-1317 16 mm
- Fig. 9 14-1318 19 mm
- Fig. 10 14-1319 20 mm
- Fig. 11 14-1320 21 mm
- Fig. 12 14-1321 23 mm
- Fig. 13 14-1322 25 mm
- Fig. 14 14-1323 30 mm
- Fig. 15 14-1324 35 mm
- Fig. 16 14-1325 40 mm

Sharp Malleable

- Fig. 00 14-1326 5 mm
- Fig. 0 14-1327 6 mm
- Fig. 1 14-1328 7 mm
- Fig. 2 14-1329 8 mm
- Fig. 3 14-1330 9 mm
- Fig. 4 14-1331 11 mm
- Fig. 5 14-1332 12 mm
- Fig. 6 14-1333 14 mm
- Fig. 7 14-1334 15 mm
- Fig. 8 14-1335 16 mm
- Fig. 9 14-1336 19 mm
- Fig. 10 14-1337 20 mm
- Fig. 11 14-1338 21 mm
- Fig. 12 14-1339 23 mm
- Fig. 13 14-1340 25 mm
- Fig. 14 14-1341 30 mm
- Fig. 15 14-1342 35 mm
- Fig. 16 14-1343 40 mm

RECAMIER
14-1308 - 14-1325

RECAMIER
14-1326 - 14-1343

1/2



Blunt Rigit

- Fig. 00 14-1344 5 mm
- Fig. 0 14-1345 6 mm
- Fig. 1 14-1346 7 mm
- Fig. 2 14-1347 8 mm
- Fig. 3 14-1348 9 mm
- Fig. 4 14-1349 11 mm
- Fig. 5 14-1350 12 mm
- Fig. 6 14-1351 14 mm
- Fig. 7 14-1352 15 mm
- Fig. 8 14-1353 16 mm
- Fig. 9 14-1354 19 mm
- Fig. 10 14-1355 20 mm
- Fig. 11 14-1356 21 mm
- Fig. 12 14-1357 23 mm
- Fig. 13 14-1358 25 mm
- Fig. 14 14-1359 30 mm
- Fig. 15 14-1360 35 mm
- Fig. 16 14-1361 40 mm

Blunt Malleable

- Fig. 00 14-1362 5 mm
- Fig. 0 14-1363 6 mm
- Fig. 1 14-1364 7 mm
- Fig. 2 14-1365 8 mm
- Fig. 3 14-1366 9 mm
- Fig. 4 14-1367 11 mm
- Fig. 5 14-1368 12 mm
- Fig. 6 14-1369 14 mm
- Fig. 7 14-1370 15 mm
- Fig. 8 14-1371 16 mm
- Fig. 9 14-1372 19 mm
- Fig. 10 14-1373 20 mm
- Fig. 11 14-1374 21 mm
- Fig. 12 14-1375 23 mm
- Fig. 13 14-1376 25 mm
- Fig. 14 14-1377 30 mm
- Fig. 15 14-1378 35 mm
- Fig. 16 14-1379 40 mm

SIMS
14-1344 - 14-1361

SIMS
14-1362 - 14-1379

Uterine Curettes

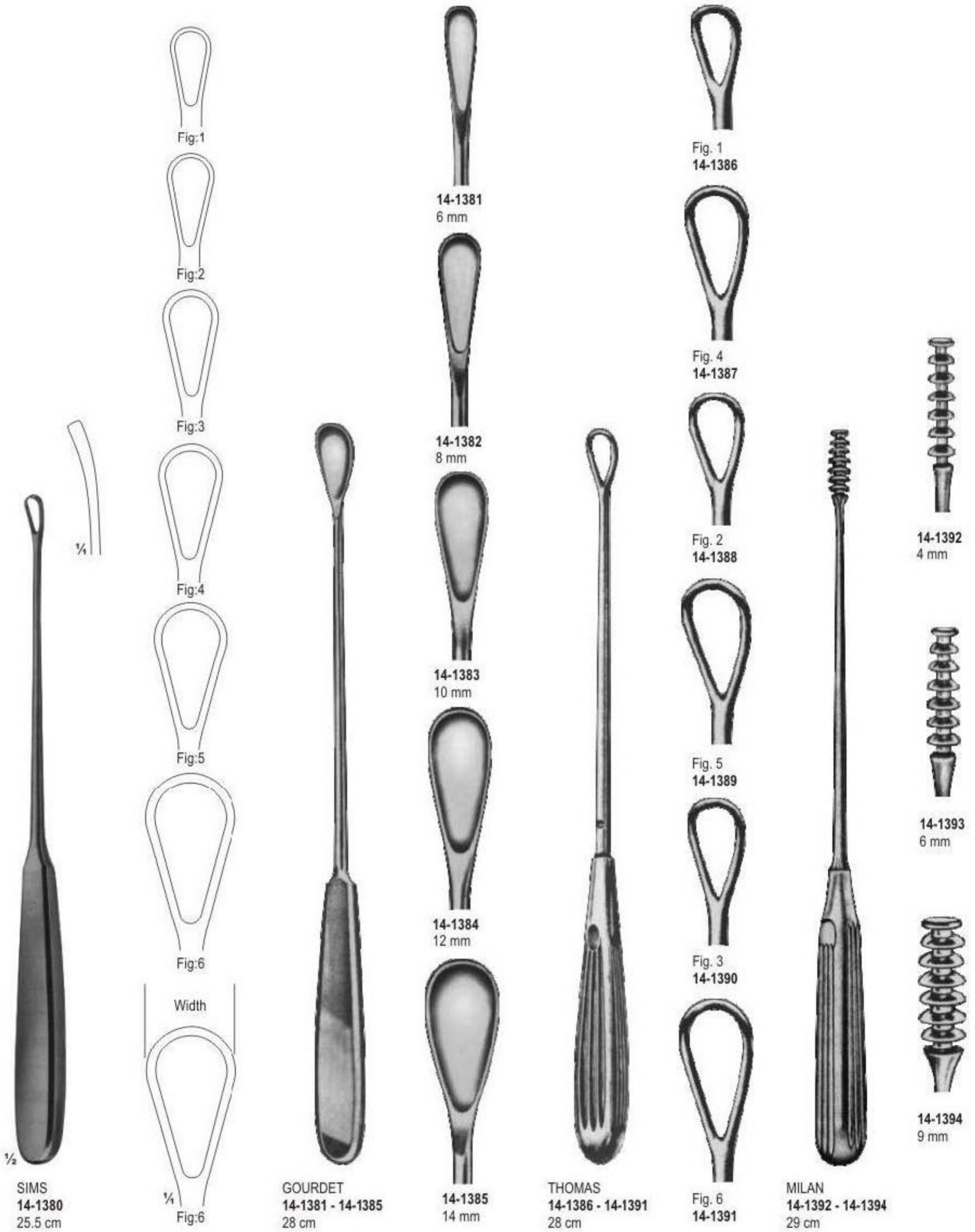

Uterine Curettes, placenta And Ovum Curettes



COLLIN
14-1395
30 cm



BUMM
14-1396
31 cm



BUMM
blunt-malleable
14-1397
29 cm

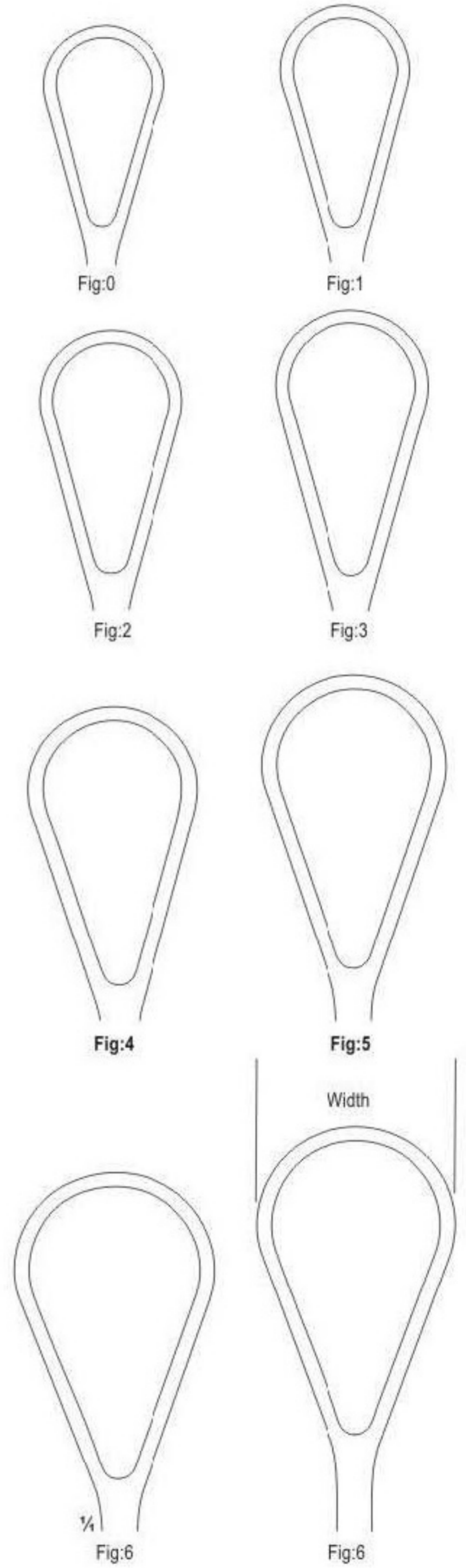

Vacuum Currettes

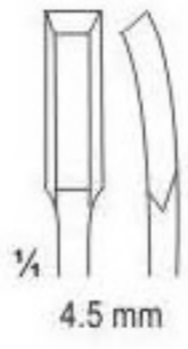
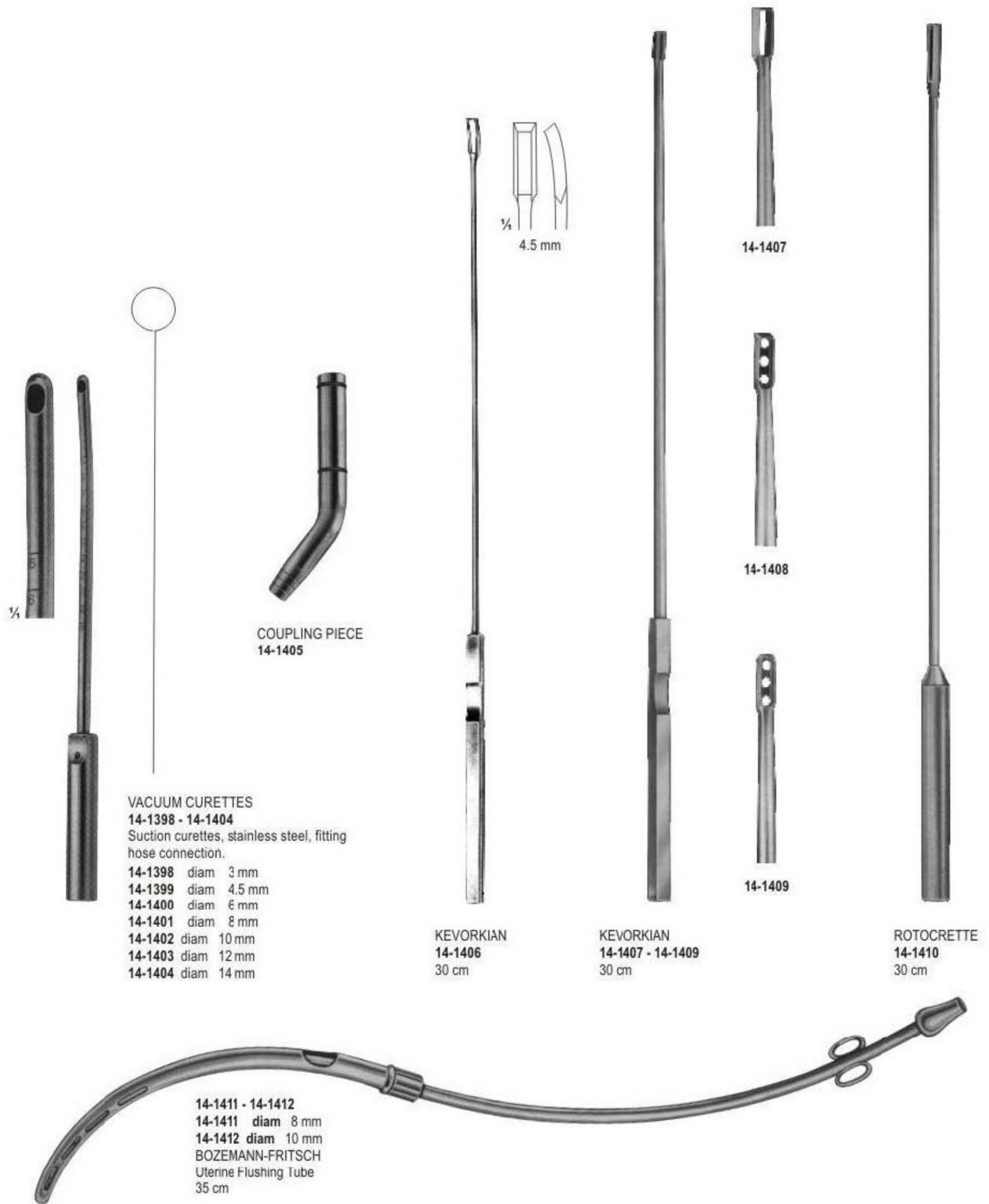

COUPLING PIECE
14-1405

- VACUUM CURETTES**
14-1398 - 14-1404
Suction currettes, stainless steel, fitting
hose connection.
- 14-1398 diam 3 mm
 - 14-1399 diam 4.5 mm
 - 14-1400 diam 6 mm
 - 14-1401 diam 8 mm
 - 14-1402 diam 10 mm
 - 14-1403 diam 12 mm
 - 14-1404 diam 14 mm

KEVORKIAN
14-1406
30 cm

KEVORKIAN
14-1407 - 14-1409
30 cm

ROTOCLETTE
14-1410
30 cm

14-1411 - 14-1412
14-1411 diam 8 mm
14-1412 diam 10 mm
BOZEMANN-FRITSCH
Uterine Flushing Tube
35 cm

Biopsy Curettes



NOVAK-SCHOECKAERT
Endometrial biopsy
curette
14-1413
24 cm



RANDALL
Endometrial
biopsy curette
14-1414
24 cm



MOD. MUNCHEN
14-1415
27 cm



ASCH
Uterine
Secretion scoop
14-1416
20 cm



BIOPSY CURETTES
Uterine Secretion scoop
14-1417
27 cm

Page 327-376



- Wire Saws & Conductor
- Skull Traction Tongs
- Cranial Rongeurs
- Clips & Applying Forceps
- Nerve & Vessel Hooks
- Dura Hooks
- Dura Dissectors
- Nerve Root Retractors
- Brain Spatulas
- Retractors For Cervical Vertebral Column
- Lamina Spreaders
- Punches
- Suction Instruments
- Rongeurs



Wire Saws And Conductor



OLIVECRONA
15-1001 - 15-1004
15-1001 30 cm
15-1002 40 cm
15-1003 50 cm
15-1004 70 cm



GIGLI
15-1005 - 15-1007
15-1005 30 cm
15-1006 40 cm
15-1007 50 cm
fine, 6 wires twisted
coares, 4 wires twisted



GIGLI
15-1008
Handle



LEBSCHE
15-1009
Conductor for
wire saws, malleable
25 cm

Skull Traction Tongs



CRUTCHFIELD
15-1010
Small Pattern



CRUTCHFIELD
15-1011
Medium Pattern



15-1012
Large Pattern
and Spare Pin



15-1013
7 cm
Drill Point



15-1014
7 cm
Drill Point

Cranial Rongeurs



1/2
DAHLGREN
15-1015
19.5 cm



1/2
DE VILBISS
15-1016
21 cm



1/2
CONE
15-1017
22.5 cm
Cranial Punch

Clips and Applying Forceps



OLIVECRONA-TOENNIS
15-1018
Clip Applying Forceps



MCKENZIE
15-1019
18.5 cm
Clip Applying Forceps



KÖLNER
15-1020
Scalp Clip



RANEY
15-1021
Scalp Clip



RANEY
15-1022
15.5 cm
Applying/Removal
Forceps

Nerve - And Vessel Hooks



WAGENER
15-1023 - 15-1026
15 cm



GRAEFE
15-1027 - 15-1029
14 cm



BROM
15-1030
Vein hook
17 cm

CRILE
15-1031
20 cm

CUSHING
15-1032 - 15-1033
19 cm

Nerve Hooks

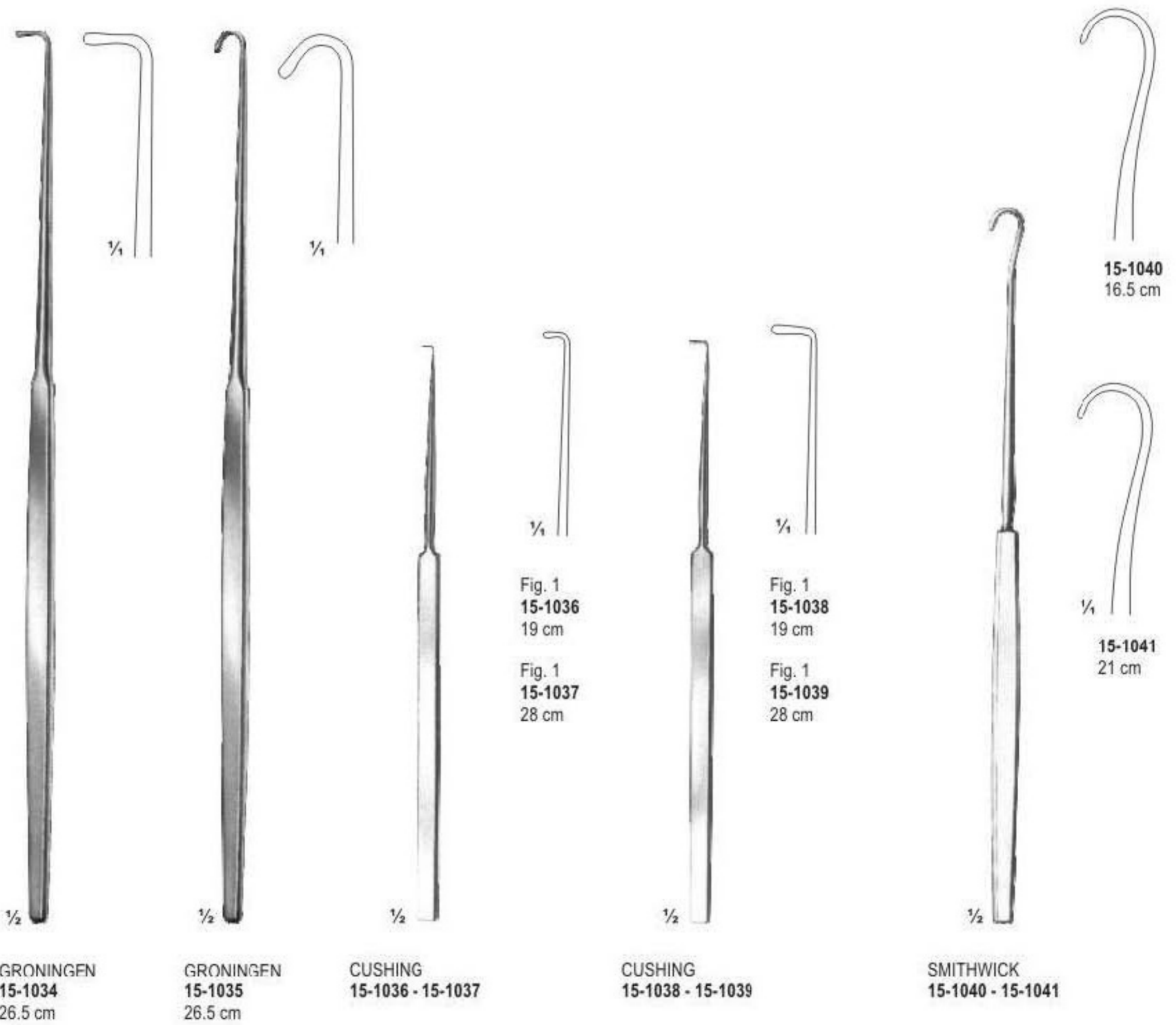

Dura Hooks



ADSON
15-1042
20 cm



GRAHAM
15-1043
16.5 cm



SACHS
15-1044
17 cm



FRAZIER
15-1045 - 15-1046

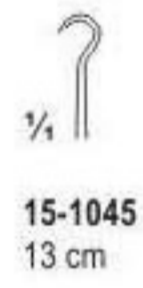

15-1045
13 cm



15-1046
18 cm

Dura Hooks



1/2

KRAYENBUHI
15-1047 - 15-1050
19 cm



1/4

Fig.1
15-1047



1/4

Fig.2
15-1048



1/4

Fig.1
15-1049



1/4

Fig.2
15-1050



1/2

CASPER
15-1051 - 15-1054
24.5 cm



15-1051



15-1052



15-1053



15-1054

Dura Hooks

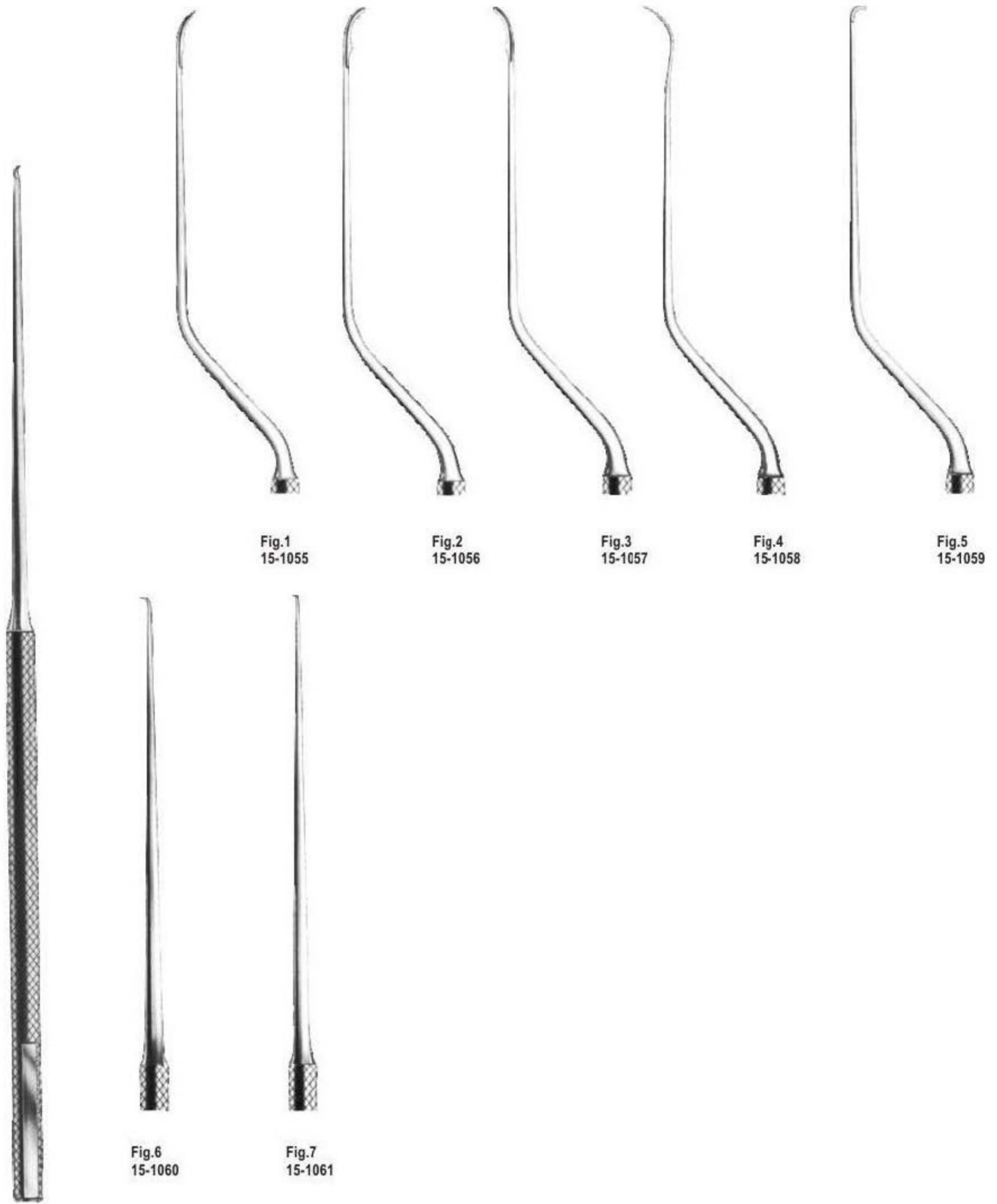

15-1055 - 15-1061

Dura Hooks

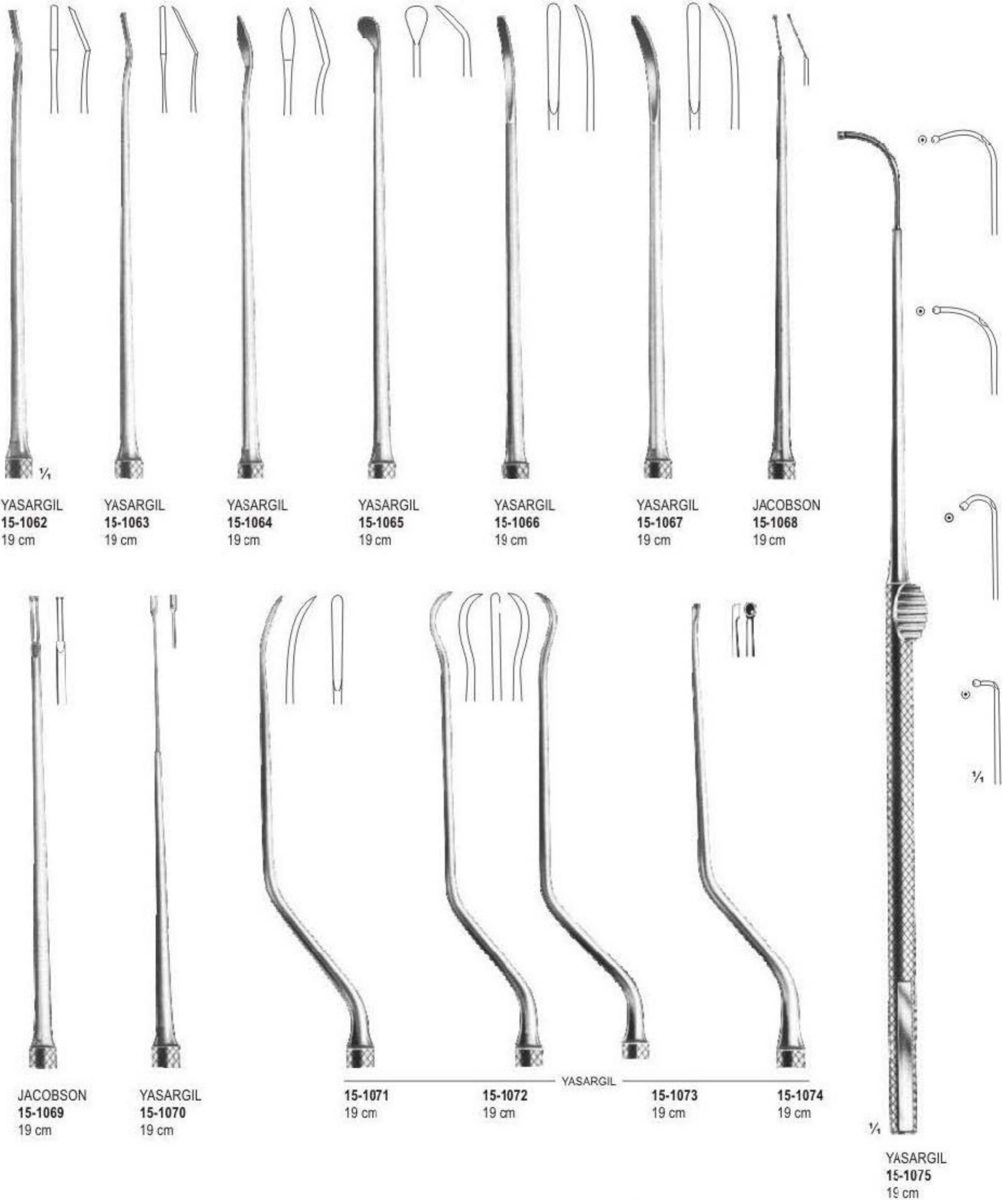

Dura Dissectors

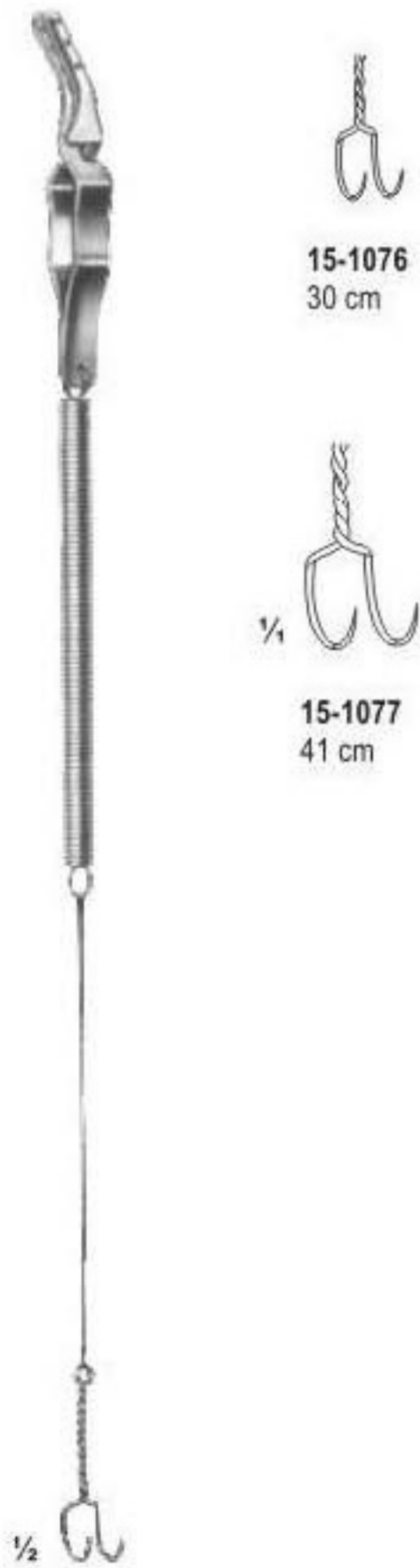

YASARGIL
15-1076 - 15-1077
Galea Hook

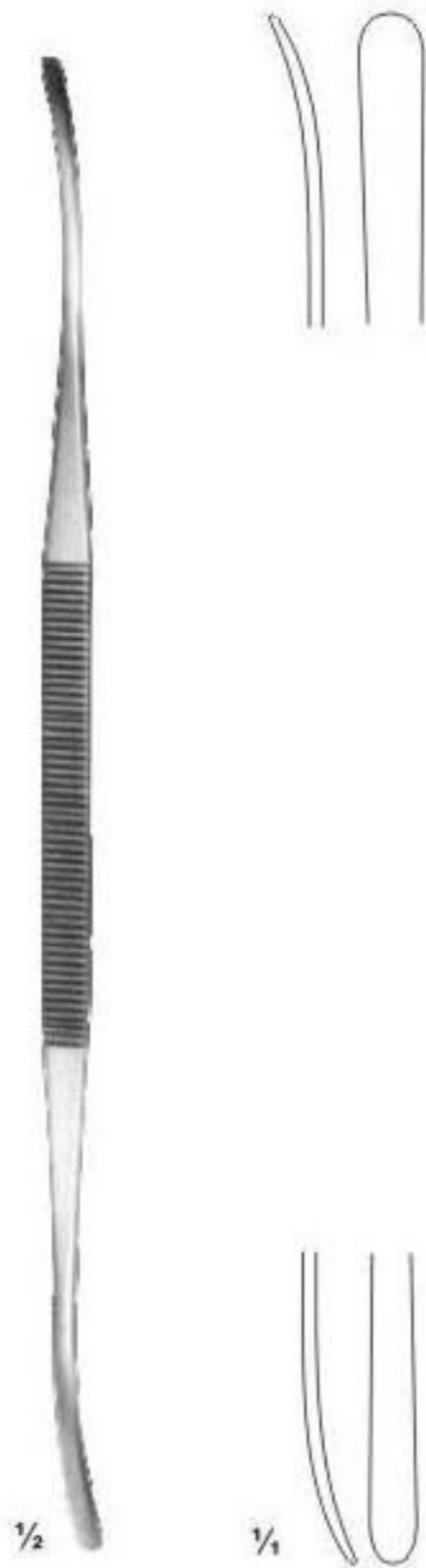

TOENNIS
15-1078
24 cm

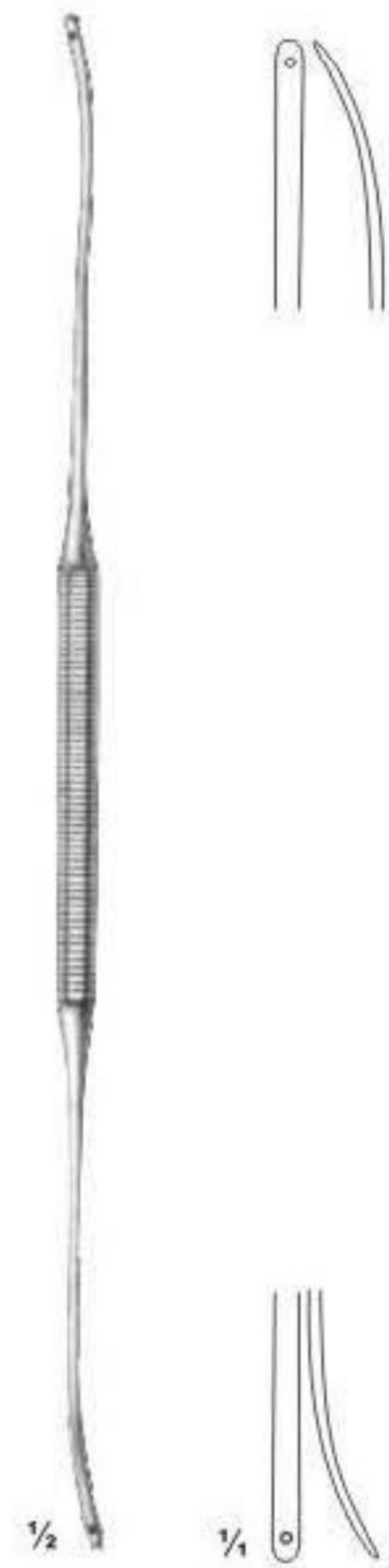

OLIVECRONA
15-1079
24 cm

Dura Dissectors

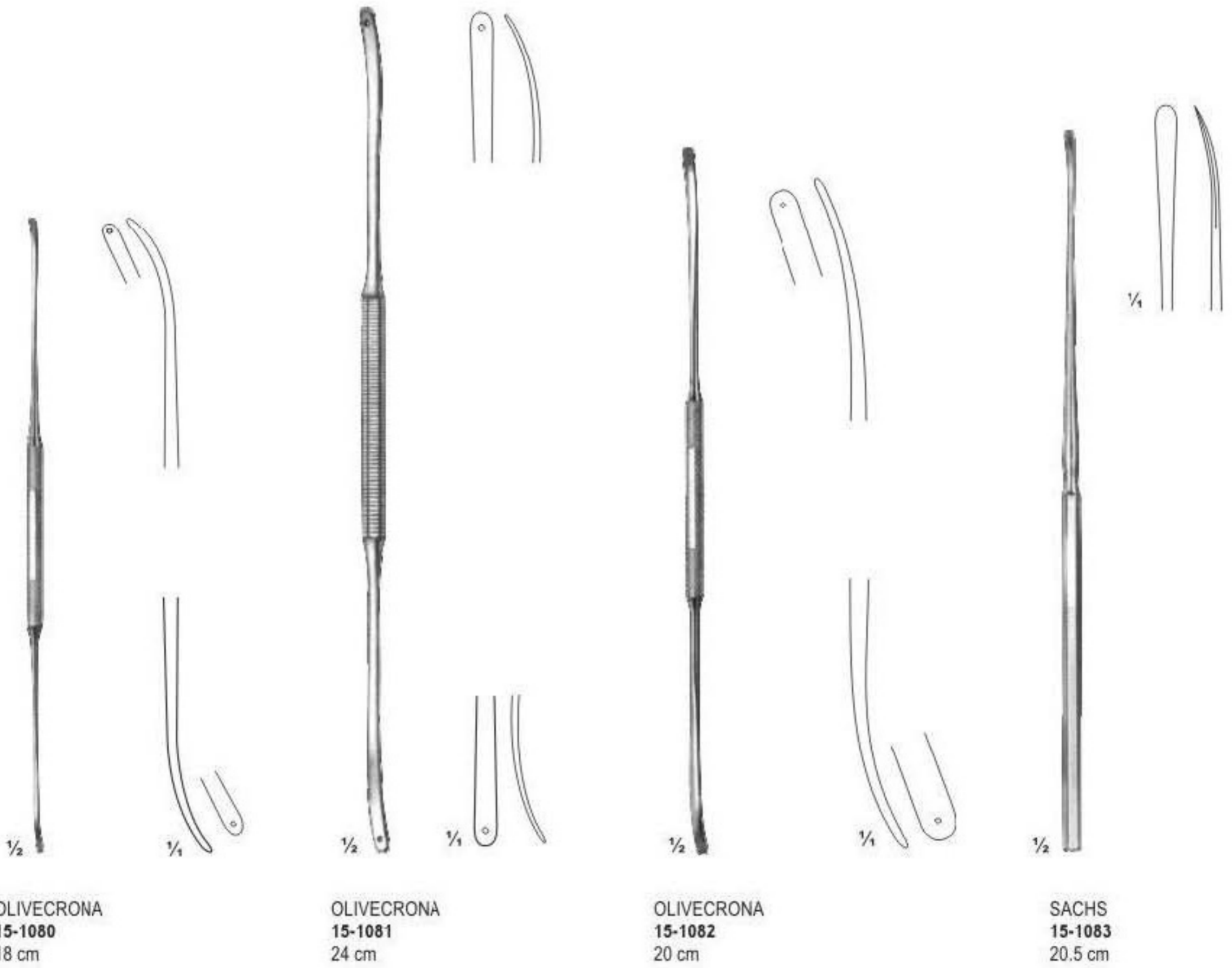

Dura Dissectors



MILLIGAN
15-1084
21.5 cm



DAVIS
15-1085
21.5 cm

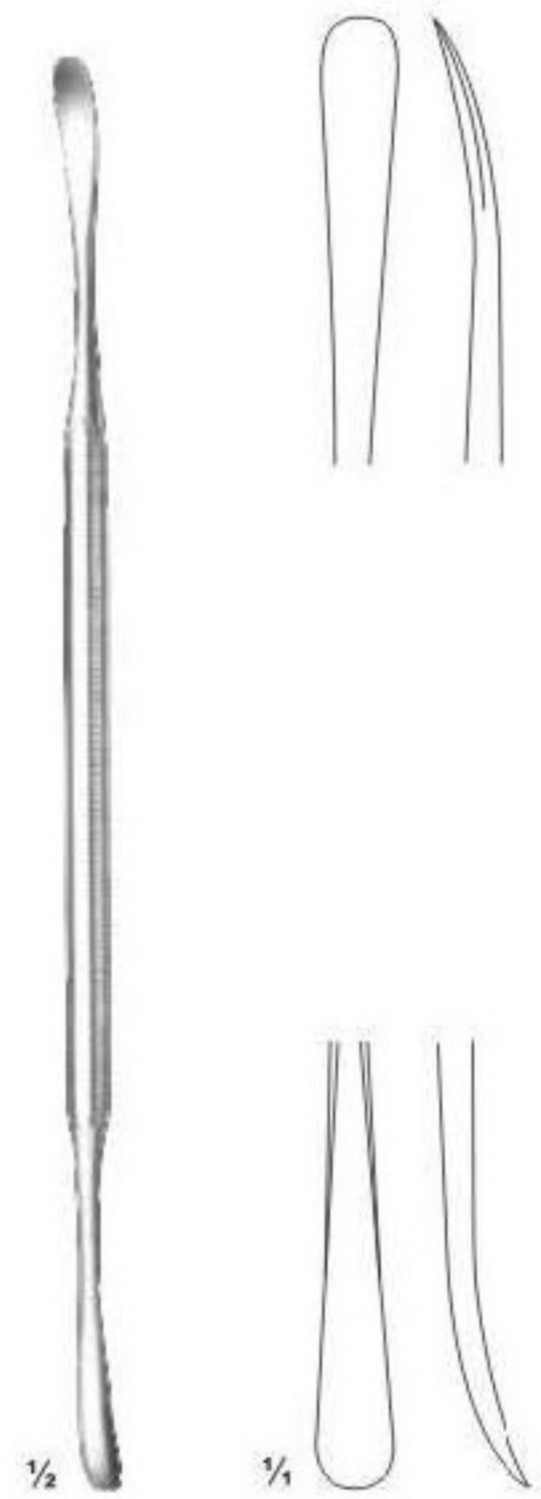

15-1086
22 cm

Dura Dissectors

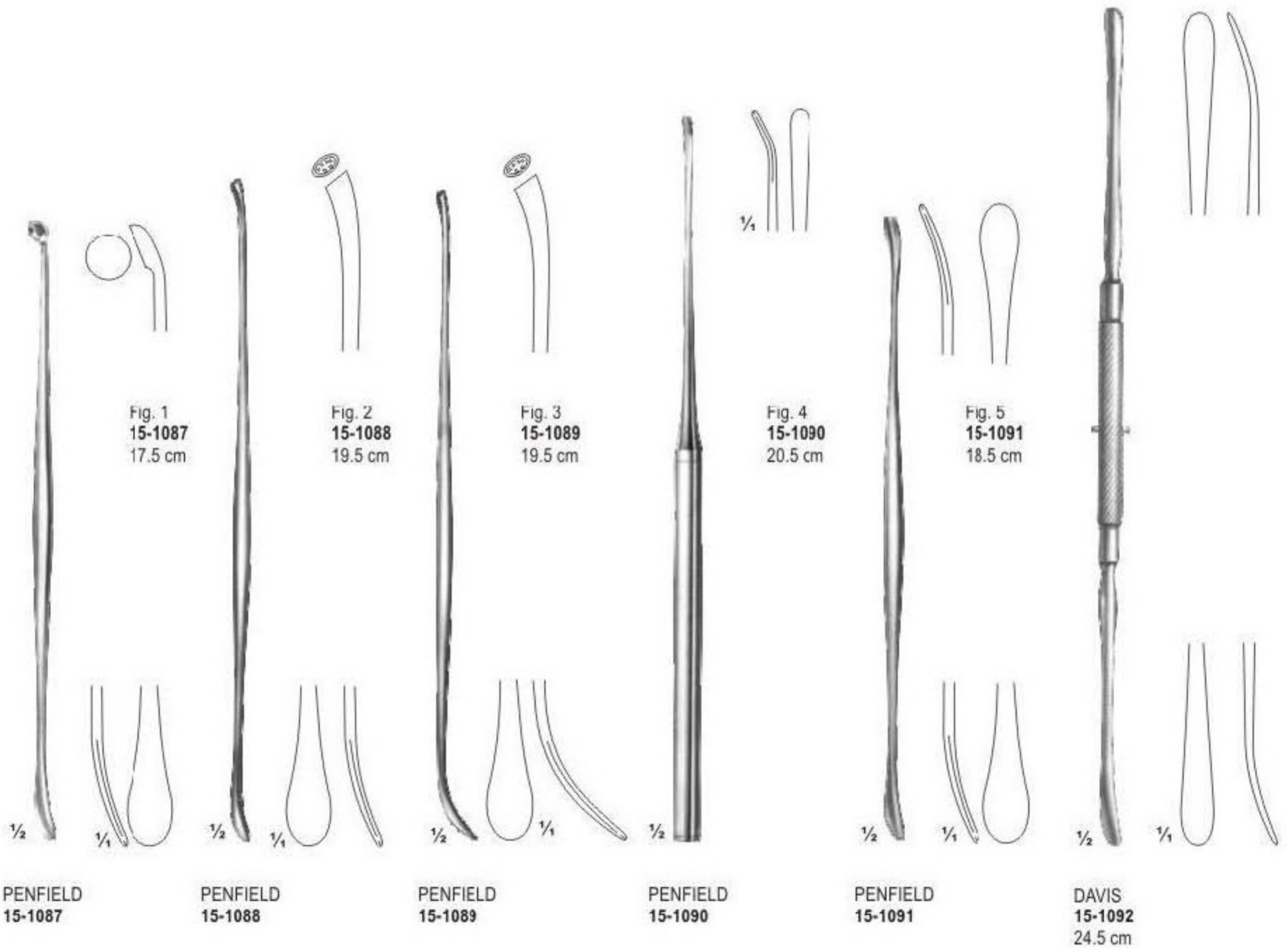

Nerve Root Retractors



HESS
Nerve Root Retractor
15-1093 - 15-1095
15-1093 17.5 cm 3 mm
15-1094 17.5 cm 5 mm
15-1095 17.5 cm 7 mm



LOVE
Nerve Root Retractor
15-1096 - 15-1098
15-1096 19 cm 0°
15-1097 19 cm 45°
15-1098 19 cm 90°



CASPAR
Nerve Root Retractor
15-1099 - 15-1101
15-1099 24.5 cm 6 mm
15-1100 24.5 cm 8 mm
15-1101 24.5 cm 10 mm



LOVE
15-1102
21 cm

Nerve Root Retractors



SCOVILLE
15-1103
23.5 cm



HOLSHER
15-1104
24 cm



SCOVILLE
15-1105
16.5 cm

Brain Spatulas

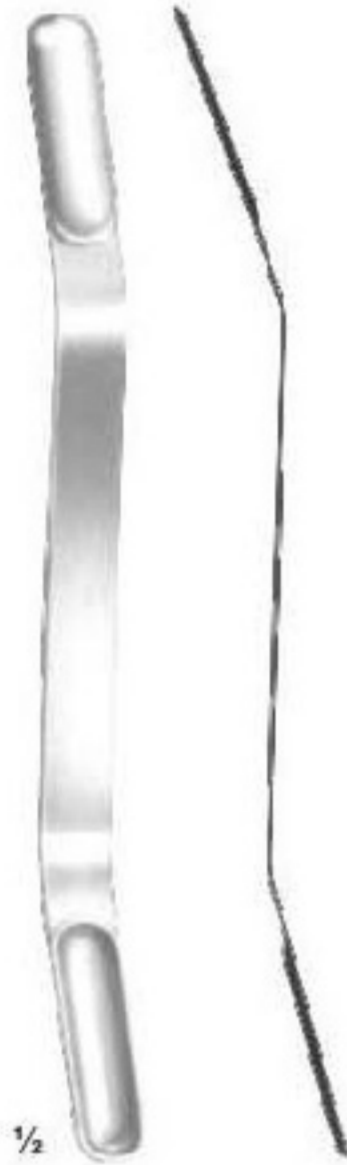

OLIVECRONA
15-1106 - 15-1109
18 cm
Concave

- 15-1106 7 + 9 mm
- 15-1107 11 + 13 mm
- 15-1108 15 + 18 mm
- 15-1109 18 + 22 mm



HEIFETZ
15-1110 - 15-1113

- 15-1110
15.5 cm
11 mm
- 15-1111
20 cm
14 mm
- 15-1112
20 cm
17 mm
- 15-1113
20 cm
20 mm



OLIVECRONA
15-1114 - 15-1117
18 cm
Convex

- 15-1114 7 + 9 mm
- 15-1115 11 + 13 mm
- 15-1116 15 + 18 mm
- 15-1117 18 + 22 mm



HEIFETZ
15-1118 - 15-1120
15.5 cm

- 15-1118
8 mm
- 15-1119
14 mm
- 15-1120
17 mm

Retractors For Cervical Vertebral Column



15-1121
Transverse Retractor hinged
65 mm regular spread
11 cm wide spread



15-1122
Transverse Retractor double-hinged
65 mm spread



15-1123
Longitudinal Retractor
double-hinged, ring handle
20.5 cm
85 mm spread



15-1124
Specula Retractor single-hinged,
11.5 cm
70mm regular spread



15-1125 - 15-1132
15-1125 23 x 35 mm
15-1126 23 x 40 mm
15-1127 23 x 45 mm
15-1128 23 x 50 mm
15-1129 23 x 55 mm
15-1130 23 x 60 mm
15-1131 23 x 65 mm
15-1132 23 x 70 mm
Medial Toothed Blades
Stainless Steel



15-1133 - 15-1137
15-1133 15 x 40 mm
15-1134 15 x 45 mm
15-1135 15 x 50 mm
15-1136 15 x 55 mm
15-1137 15 x 60 mm
Small Lateral Blades
Stainless Steel



15-1138 - 15-1144
15-1138 23 x 40 mm
15-1139 23 x 45 mm
15-1140 23 x 50 mm
15-1141 23 x 55 mm
15-1142 23 x 60 mm
15-1143 23 x 65 mm
15-1144 23 x 70 mm
Lateral Serrated Blades
Stainless Steel



Cervical Blades
Stainless Steel – fenestrated
15-1145 - 15-1146
15-1145 25 x 50 mm
15-1146 25 x 60 mm



15-1147 - 15-1155
15-1147 23 x 35 mm
15-1148 23 x 40 mm
15-1149 23 x 45 mm
15-1150 23 x 50 mm
15-1151 23 x 55 mm
15-1152 23 x 60 mm
15-1153 23 x 65 mm
15-1154 23 x 70 mm
15-1155 23 x 75 mm
Blunt Blades
Stainless Steel



15-1156 - 15-1160
15-1156 23 x 40 mm
15-1157 23 x 45 mm
15-1158 23 x 50 mm
15-1159 23 x 55 mm
15-1160 23 x 60 mm
Medial Toothed Blades
Aluminium – rotatating



15-1161 - 15-1165
15-1161 23 x 40 mm
15-1162 23 x 45 mm
15-1163 23 x 50 mm
15-1164 23 x 55 mm
15-1165 23 x 60 mm
Lateral Serrated Blades
Aluminium – rotatating



15-1166 - 15-1170
15-1166 23 x 45 mm
15-1167 23 x 50 mm
15-1168 23 x 55 mm
15-1169 23 x 60 mm
15-1170 23 x 65 mm
Blunt Blades
Aluminium – rotatating

Retractors For Cervical Vertebral Column



15-1171
Transverse Retractor hinged
65 mm spread



15-1172
Specula Retractor single-hinged
11.5 cm,
70 mm spread



15-1173
Longitudinal Retractor
single-hinged ring handle
17.5 cm
70 mm spread



15-1174 - 15-1181
15-1174 20 x 40 mm
15-1175 20 x 45 mm
15-1176 20 x 50 mm
15-1177 20 x 55 mm
15-1178 20 x 60 mm
15-1179 20 x 65 mm
15-1180 20 x 70 mm
15-1181 20 x 75 mm
Medial Toothed Blades



15-1182 - 15-1192
15-1182 20 x 25 mm
15-1183 20 x 30 mm
15-1184 20 x 35 mm
15-1185 20 x 40 mm
15-1186 20 x 45 mm
15-1187 20 x 50 mm
15-1188 20 x 55 mm
15-1189 20 x 60 mm
15-1190 20 x 65 mm
15-1191 20 x 70 mm
15-1192 20 x 75 mm
Lateral Serrated Blades



15-1193 - 15-1202
15-1193 20 x 30 mm
15-1194 20 x 35 mm
15-1195 20 x 40 mm
15-1196 20 x 45 mm
15-1197 20 x 50 mm
15-1198 20 x 55 mm
15-1199 20 x 60 mm
15-1200 20 x 65 mm
15-1201 20 x 70 mm
15-1202 20 x 75 mm
Blunt Blades



15-1203 - 15-1210
15-1203 20 x 35 mm
15-1204 20 x 40 mm
15-1205 20 x 45 mm
15-1206 20 x 50 mm
15-1207 20 x 55 mm
15-1208 20 x 60 mm
15-1209 20 x 65 mm
15-1210 20 x 70 mm
Medial Toothed Blades
fenestrated



15-1211 - 15-1220
15-1211 20 x 25 mm
15-1212 20 x 30 mm
15-1213 20 x 35 mm
15-1214 20 x 40 mm
15-1215 20 x 45 mm
15-1216 20 x 50 mm
15-1217 20 x 55 mm
15-1218 20 x 60 mm
15-1219 20 x 65 mm
15-1220 20 x 70 mm
Lateral Serrated Blades
Fenestrated



15-1221 - 15-1229
15-1221 20 x 35 mm
15-1222 20 x 40 mm
15-1223 20 x 45 mm
15-1224 20 x 50 mm
15-1225 20 x 55 mm
15-1226 20 x 60 mm
15-1227 20 x 65 mm
15-1228 20 x 70 mm
15-1229 20 x 75 mm
Blunt Blades Fenestrated

Retractors For Cervical Vertebral Column



15-1230
Transverse Retractor hinged
60 mm spread



15-1231
Transverse Retractor double-hinged
65 mm spread



15-1232
Longitudinal Retractor
single-hinged ring handle
17.5 cm
70 mm spread



15-1233
Longitudinal Retractor
single-hinged ring handle
17.5 cm
70 mm spread

Retractors For Cervical Vertebral Column



15-1234 - 15-1240
 15-1234 12 x 40 mm
 15-1235 12 x 45 mm
 15-1236 12 x 50 mm
 15-1237 12 x 55 mm
 15-1238 12 x 60 mm
 15-1239 12 x 65 mm
 15-1240 12 x 75 mm
 Small Lateral Serrated
 Blades PEEK



15-1241 - 15-1247
 15-1241 23 x 40 mm
 15-1242 23 x 45 mm
 15-1243 23 x 50 mm
 15-1244 23 x 55 mm
 15-1245 23 x 60 mm
 15-1246 23 x 65 mm
 15-1247 23 x 75 mm
 Lateral Serrated Blades
 PEEK



15-1248 - 15-1254
 15-1248 23 x 40 mm
 15-1249 23 x 45 mm
 15-1250 23 x 50 mm
 15-1251 23 x 55 mm
 15-1252 23 x 60 mm
 15-1253 23 x 65 mm
 15-1254 23 x 75 mm
 Blunt Blades PEEK



15-1255 - 15-1261
 15-1255 23 x 40 mm
 15-1256 23 x 45 mm
 15-1257 23 x 50 mm
 15-1258 23 x 55 mm
 15-1259 23 x 60 mm
 15-1260 23 x 65 mm
 15-1261 23 x 75 mm
 Medial Toothed Blades
 PEEK



15-1262 - 15-1268
 15-1262 23 x 40 mm
 15-1263 23 x 45 mm
 15-1264 23 x 50 mm
 15-1265 23 x 55 mm
 15-1266 23 x 60 mm
 15-1267 23 x 65 mm
 15-1268 23 x 75 mm
 Lateral Serrated Blades
 PEEK – rotating



15-1269 - 15-1275
 15-1269 23 x 40 mm
 15-1270 23 x 45 mm
 15-1271 23 x 50 mm
 15-1272 23 x 55 mm
 15-1273 23 x 60 mm
 15-1274 23 x 65 mm
 15-1275 23 x 75 mm
 Blunt Blades
 PEEK – rotating

Retractors For Cervical Vertebral Column



15-1276
Transverse Retractor double-hinged
quick connect 72 mm spread, side-loading



15-1277
Longitudinal Retractor double-hinged,
ring handle, quick connect
18.5 cm
75 mm spread, side-loading



15-1278
Specula Retractor single-hinged,
quick connect
11.5 cm
70 mm spread, side-loading



15-1279
Quick Connect Blade
Positioner Handle
21 cm
for quick connect
blades only



15-1280 - 15-1284
15-1280 23 x 40 mm
15-1281 23 x 45 mm
15-1282 23 x 50 mm
15-1283 23 x 55 mm
15-1284 23 x 60 mm
Medial Toothed Blades
Stainless Steel
quick connect



15-1285 - 15-1289
15-1285 23 x 40 mm
15-1286 23 x 45 mm
15-1287 23 x 50 mm
15-1288 23 x 55 mm
15-1289 23 x 60 mm
Lateral Serrated Blades
Stainless Steel
quick connect



15-1290 - 15-1294
15-1290 23 x 45 mm
15-1291 23 x 50 mm
15-1292 23 x 55 mm
15-1293 23 x 60 mm
15-1294 23 x 65 mm
Blunt Blades
Stainless Steel
quick connect



15-1295 - 15-1299
15-1295 23 x 40 mm
15-1296 23 x 45 mm
15-1297 23 x 50 mm
15-1298 23 x 55 mm
15-1299 23 x 60 mm
Medial Toothed Blades
Titanium
quick connect



15-1300 - 15-1304
15-1300 23 x 40 mm
15-1301 23 x 45 mm
15-1302 23 x 50 mm
15-1303 23 x 55 mm
15-1304 23 x 60 mm
Lateral Serrated Blades
Titanium
quick connect



15-1305 - 15-1309
15-1305 23 x 45 mm
15-1306 23 x 50 mm
15-1307 23 x 55 mm
15-1308 23 x 60 mm
15-1309 23 x 65 mm
Blunt Blades
Titanium
quick connect

Retractors For Cervical Vertebral Column



15-1310
Caspar Cervical Spine Retractor
stainless steel, complete set for transverse retraction, 65 mm
spread, adjustable, with 5 medial and 5 lateral stainless steel,
blades 40, 45, 50, 55, 60 mm

15-1311
TI Caspar Cervical Spine Retractor
titanium, complete set for transverse retraction, 65 mm
spread, adjustable, with 5 medial and 5 lateral titanium
blades 40, 45, 50, 55, 60 mm

Retractors For Cervical Vertebral Column



15-1312
Caspar Microdiscectomy Retractor
for microsurgical treatment of
herniated lumbar discs
45 mm spread



15-1313 - 15-1321
15-1313 35 mm
15-1314 40 mm
15-1315 45 mm
15-1316 50 mm
15-1317 55 mm
15-1318 60 mm
15-1319 65 mm
15-1320 75 mm
15-1321 85 mm
Lateral Blades



15-1322 - 15-1328
15-1322 40 mm
15-1323 45 mm
15-1324 50 mm
15-1325 55 mm
15-1326 60 mm
15-1327 65 mm
15-1328 70 mm
Paraspina Blades



15-1329 - 15-1338
15-1329 40 mm
15-1330 45 mm
15-1331 50 mm
15-1332 55 mm
15-1333 60 mm
15-1334 65 mm
15-1335 70 mm
15-1336 75 mm
15-1337 80 mm
15-1338 85 mm
Lumbar Speculum
fenestrated

Retractors For Cervical Vertebral Column



15-1343 - 15-1348
15-1343 20 x 30 mm
15-1344 20 x 40 mm
15-1345 20 x 50 mm
15-1346 20 x 60 mm
15-1347 20 x 70 mm
15-1348 20 x 80 mm
 McCulloch 4-teeth
 Narrow Muscle Blades



15-1349 - 15-1354
15-1349 20 x 30 mm
15-1350 20 x 40 mm
15-1351 20 x 50 mm
15-1352 20 x 60 mm
15-1353 20 x 70 mm
15-1354 20 x 80 mm
 McCulloch 6-teeth
 Wide Muscle Blades

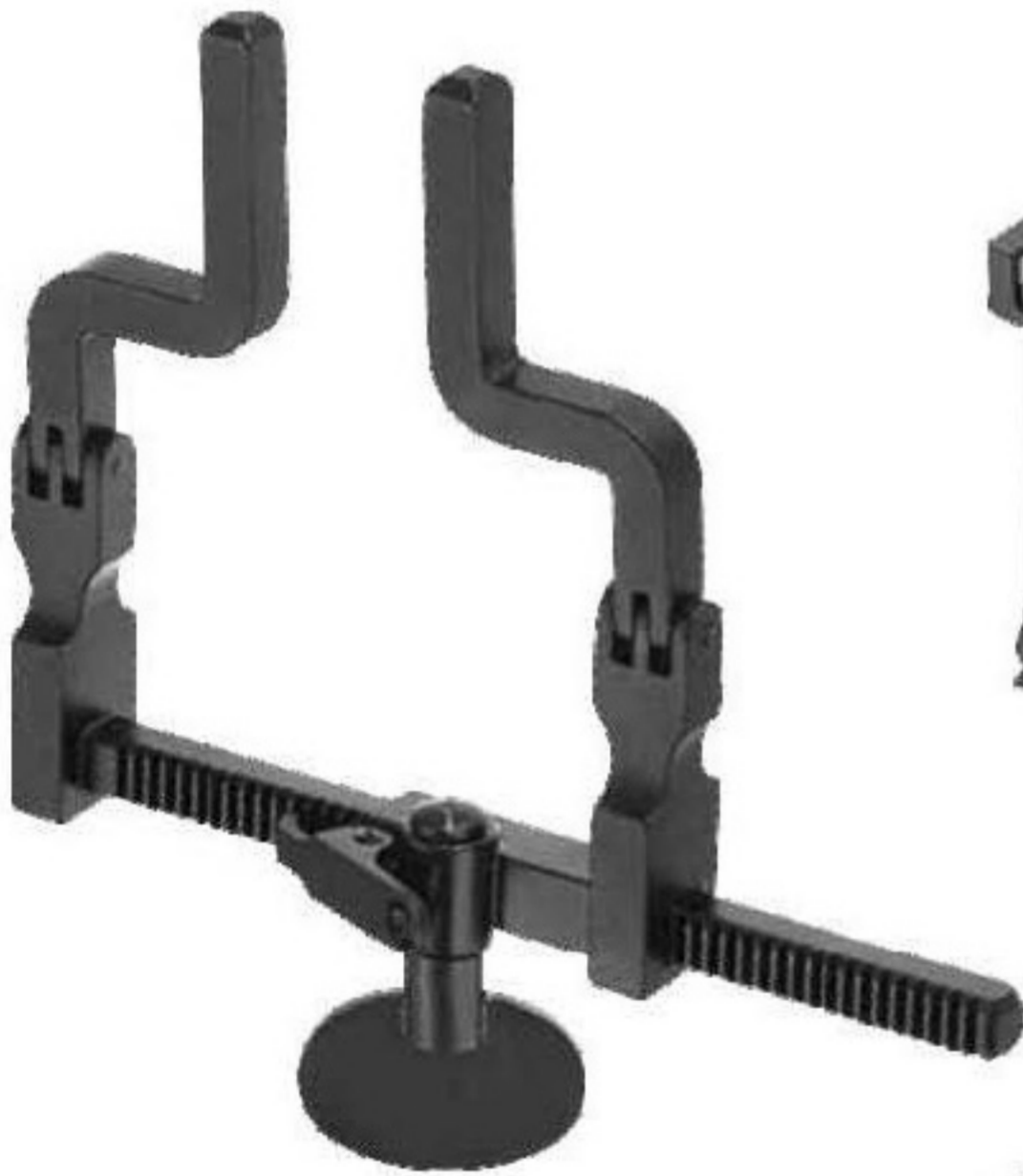

McCulloch Lumbar Spine Retractor for Microdiscectomy,
 black silicone bead
15-1339 68 mm spread, hinged
15-1340 68 mm spread, rigid
15-1341 90 mm spread, rigid
 McCulloch Lumbar Spine Retractor Tray
15-1342 Tray 265 x 265 mm for Container (not illustrated)



15-1355 - 15-1360
15-1355 20 x 30 mm
15-1356 20 x 40 mm
15-1357 20 x 50 mm
15-1358 20 x 60 mm
15-1359 20 x 70 mm
15-1360 20 x 80 mm
 McCulloch 2-teeth
 Thin Muscle Blades



15-1361 - 15-1368
15-1361 20 mm
15-1362 30 mm
15-1363 40 mm
15-1364 50 mm
15-1365 60 mm
15-1366 70 mm
15-1367 80 mm
15-1368 90 mm
 McCulloch Hook Blades



15-1369 - 15-1376
15-1369 20 mm
15-1370 30 mm
15-1371 40 mm
15-1372 50 mm
15-1373 60 mm
15-1374 70 mm
15-1375 80 mm
15-1376 90 mm
 McCulloch toothed
 Hook Blades



15-1377 - 15-1379
15-1377 20 x 50 mm
15-1378 20 x 60 mm
15-1379 20 x 70 mm
 McCulloch 2-teeth
 Cervical Blades

Retractors For Cervical Vertebral Column



15-1380 - 15-1381
Caspar Vertebral Column Retractor for Laminectomy and Hemilaminectomy (Lumbar, Thoracic, Cervical), stainless steel, complete set, 145 mm spread,
15-1380 12.5 cm arms, consisting of
15-1381 14.5 cm spread, hinged includes Screw Driver for spreading bar



15-1382
Screw driver four spreading bar



15-1333
Blade Changing Forceps 11.5 cm



15-1384 - 15-1385
15-1384 38 mm
15-1385 58 mm



15-1386 - 15-1393
15-1386 22 x 32 mm
15-1387 22 x 37 mm
15-1388 22 x 43 mm
15-1389 22 x 47 mm
15-1390 22 x 52 mm
15-1391 22 x 57 mm
15-1392 22 x 62 mm
15-1393 22 x 67 mm



15-1394 - 15-1401
15-1394 37 x 32 mm
15-1395 37 x 37 mm
15-1396 37 x 43 mm
15-1397 37 x 47 mm
15-1398 37 x 52 mm
15-1399 37 x 57 mm
15-1400 37 x 62 mm
15-1401 37 x 67 mm



15-1402 - 15-1409
15-1402 57 x 32 mm
15-1403 57 x 37 mm
15-1404 57 x 43 mm
15-1405 57 x 47 mm
15-1406 57 x 52 mm
15-1407 57 x 57 mm
15-1408 57 x 62 mm
15-1409 57 x 67 mm

Retractors For Cervical Vertebral Column



CASPAR
15-1410
Distractor only for use in surgical procedures from the left approach the right approach for the upper cervical spine Distractor as above but with elongated toothed bar for multilevel (more than 2) distraction

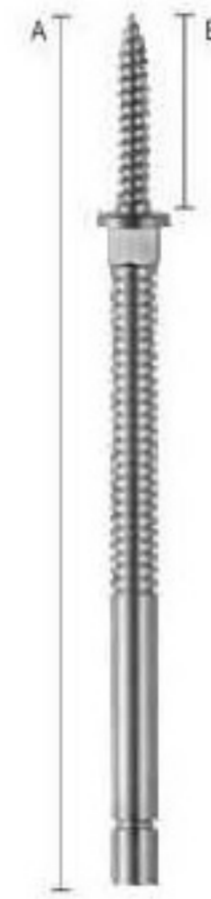

DISTRACTION PIN A/B
15-1411 - 15-1414
15-1411 66/12 mm
15-1412 68/14 mm
15-1413 70/16 mm
15-1414 72/18 mm



TWIST DRILL
15-1415



DRILL GUIDE
15-1416



SCREW/ DRIVER
15-1417

Retractors For Cervical Vertebral Column



CASPAR
15-1418
Distractor only for use in surgical procedures from the left approach the right approach for the upper cervical spine Distractor as above but with elongated toothed bar for multilevel (more than 2) distraction

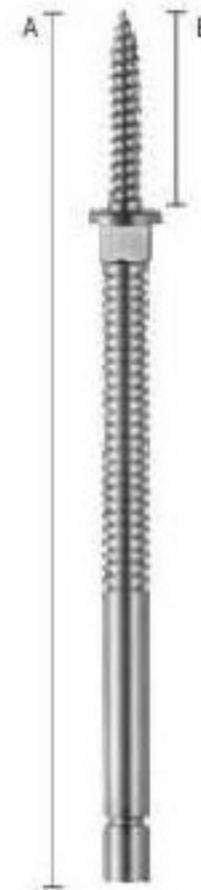

DISTRACTION PIN A/B
15-1419 - 15-1422
15-1419 66/12 mm
15-1420 68/14 mm
15-1421 70/16 mm
15-1422 72/18 mm



TWIST DRILL
15-1423



DRILL GUIDE
15-1424



SCREW DRIVER
15-1425

Retractors For Cervical Vertebral Column



CLOWARD-TYPE
15-1426
Vertebra Spreaders
13 cm
18 mm spread



15-1427
one pointed tip
7 cm
arm, 80 mm spread



three pointed tips
15-1428
3.5 cm arm,
70 mm spread
15-1429
10 cm
arm, 70 mm spread



INGE
Lamina Spreaders
15-1430 - 15-1431
15-1430 16.5 cm
15-1431 27 cm

Retractors For Cervical Vertebral Column

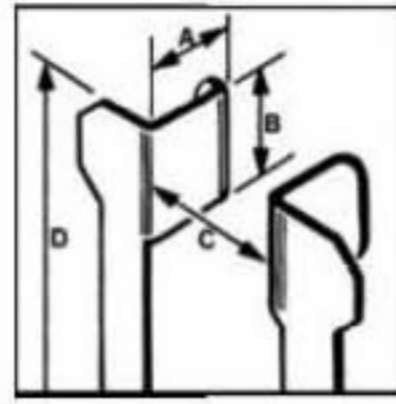

with 3 x 2 pairs of movable blunt blades

	A	B	C	D
15-1432	40 mm	12 mm	110 mm	132 mm
	50 mm	12 mm		
	65 mm	12 mm		

BADGLEY

	A	B	C	D
15-1433	48 mm	45 mm	170 mm	110 mm



Retractors For Cervical Vertebral Column

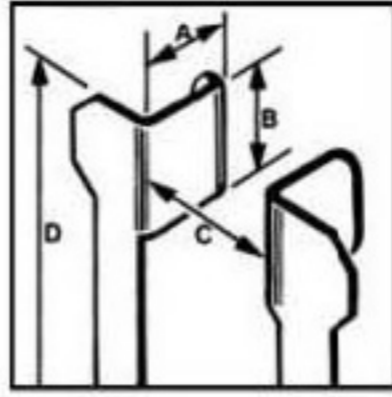

SCOVILLE-HAVERFIELD

	A	B	C	D
15-1434	50 mm	35 mm	140 mm	140 mm
	50 mm			
with 1 each blade 29-3165.50 and 29-3162.51				
Frame only, hinged:				
15-1435			140 mm	140 mm



Toothed:

- 15-1442 - 15-1447
- 15-1442 63 mm x 26 mm
- 15-1443 66 mm x 30 mm
- 15-1444 89 mm x 26 mm
- 15-1445 51 mm x 51 mm
- 15-1446 63 mm x 51 mm
- 15-1447 76 mm x 51 mm



3-prongs:

- 15-1436 44 mm x 38 mm

4-prongs:

- 15-1437 - 15-1441
- 15-1437 41 mm x 38 mm
- 15-1438 66 mm x 48 mm
- 15-1439 48 mm x 51 mm
- 15-1440 63 mm x 63 mm
- 15-1441 82 mm x 58 mm



Hook-shaped, blunt:

- 15-1448 - 15-1449
- 15-1448 50 mm
- 15-1449 75 mm



Williams

- 15-1450 for micro-surgical treatment of herniated discs 17 cm
- w = 10 mm
- 15-1451 10 x 50 mm
- 15-1452 10 x 60 mm
- 15-1453 10 x 70 mm

w = 20 mm

- 15-1454 20 x 50 mm
- 15-1455 20 x 60 mm
- 15-1456 20 x 70 mm



Williams

- 15-1457 for micro-surgical treatment of herniated discs 17 cm
- w = 10 mm
- 15-1458 10 x 50 mm
- 15-1459 10 x 60 mm
- 15-1460 10 x 70 mm

w = 20 mm

- 15-1461 20 x 50 mm
- 15-1462 20 x 60 mm
- 15-1463 20 x 70 mm

Retractors For Cervical Vertebral Column



CLOWARD-TYPE

15-1464

with slide lock Cervical Retractor Set with slide-lock complete with 14 blades, 25 cm

15-1465 – 15-1466

15-1467 Retractor Body only (without blades), 25 cm



15-1468

Cervical Retractor Set with slide-lock complete with 14 blades, 16 cm

15-1469 – 15-1470

15-1471 Retractor Body only (without blades), 16 cm



15-1472 - 15-1478

15-1472 25 mm

15-1473 30 mm

15-1474 35 mm

15-1475 40 mm

15-1476 45 mm

15-1477 50 mm

15-1478 55 mm

blunt



15-1479 - 15-1485

15-1479 25 mm

15-1480 30 mm

15-1481 35 mm

15-1482 40 mm

15-1483 45 mm

15-1484 50 mm

15-1485 55 mm

blunt

Retractors For Cervical Vertebral Column



CLOWARD-TYPE
15-1486
25.5 cm
with ball snap closure Cervical Retractor
complete consisting of Retractor Body
25.5 cm, 110 mm spread (without blades)



15-1487 - 15-1491
15-1487 15 x 40 mm
15-1488 15 x 45 mm
15-1489 15 x 50 mm
15-1490 15 x 55 mm
15-1491 15 x 60 mm
serrated



15-1492 - 15-1496
15-1492 15 x 40 mm
15-1493 15 x 45 mm
15-1494 15 x 50 mm
15-1495 15 x 55 mm
15-1496 15 x 60 mm
Blunt

Retractors For Cervical Vertebral Column



CONE
15-1497 - 15-1504
15-1497 14 cm, 18 mm 3 x 4
15-1498 16 cm, 18 mm 3 x 4
15-1499 20 cm, 20 mm 3 x 4
15-1500 24 cm, 27 mm 3 x 4
15-1501 14 cm, 18 mm 3 x 4
15-1502 16 cm, 18 mm 3 x 4
15-1503 20 cm, 20 mm 3 x 4
15-1504 24 cm, 27 mm 3 x 4
prongs blunt



MARKHAM-MEYERDING
15-1505
18 cm, 50 x 25 mm left
Hemilaminectomy Retractor

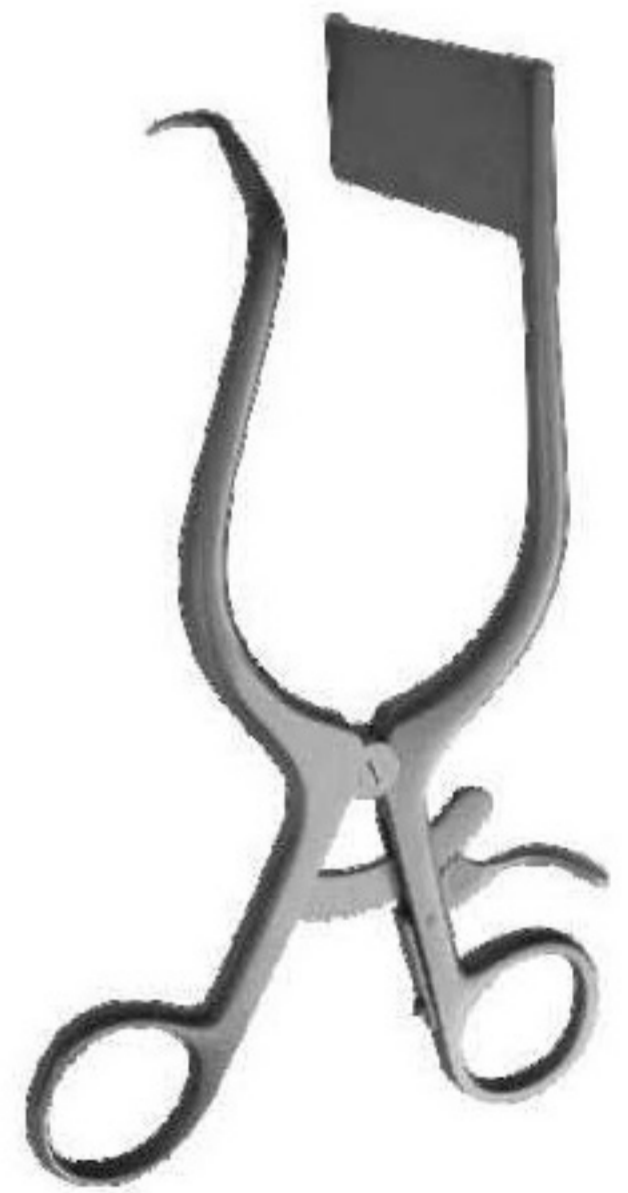

MARKHAM-MEYERDING
15-1506
18 cm, 50 x 25 mm right
Hemilaminectomy Retractor

Retractors For Cervical Vertebral Column



MINI-WEITLANER
15-1507 - 15-1508
15-1507 11 cm, 16 mm 2 x 3 prongs sharp
15-1508 11 cm, 16 mm 2 x 3 prongs blunt



WEITLANER
15-1509 - 15-1516
15-1509 13 cm, 18 mm 3 x 4 prongs sharp
15-1510 16 cm, 18 mm 3 x 4 prongs sharp
15-1511 20 cm, 21 mm 3 x 4 prongs sharp
15-1512 25 cm, 27 mm 3 x 4 prongs sharp
15-1513 13 cm, 18 mm 3 x 4 prongs blunt
15-1514 16 cm, 18 mm 3 x 4 prongs blunt
15-1515 20 cm, 21 mm 3 x 4 prongs blunt
15-1516 25 cm, 27 mm 3 x 4 prongs blunt



ANDERSON-ADSON
 Cerebellar Retractor
15-1517 20 cm 4 x 4 prongs sharp

Retractors For Cervical Vertebral Column



WEITLANER
15-1518 - 15-1519
15-1518 26 cm, 27 mm 5 x 6 prongs sharp
15-1519 26 cm, 27 mm 5 x 6 prongs blunt



HEMILAMINECTOMY
15-1520 - 15-1521
15-1520 29 cm, 42 mm 6 x 6 prongs sharp
15-1521 29 cm, 42 mm 6 x 6 prongs blunt



15-1522 - 15-1525
 Right blade 42 mm, left blade 22 mm deep
15-1522 29 cm, 22/42 mm 6 x 6 prongs sharp
15-1523 29 cm, 22/42 mm 6 x 6 prongs blunt

 Right blade 22 mm, left blade 42 mm deep
15-1524 29 cm, 22/42 mm 6 x 6 prongs sharp
15-1525 29 cm, 22/42 mm 6 x 6 prongs blunt

Retractors For Cervical Vertebral Column



SCALP CONTOUR

15-1526 - 15-1529

15-1526 14 cm, 18 mm 1 x 1 prongs blunt

15-1527 14 cm, 18 mm 3 x 3 prongs blunt

15-1528 14 cm, 18 mm 3 x 4 prongs sharp

15-1529 14 cm, 18 mm 3 x 4 prongs blunt



BECKMANN-ADSON

15-1530 - 15-1535

15-1530 31 cm, 25 mm 4 x 4 prongs sharp

15-1531 31 cm, 37 mm 4 x 4 prongs sharp

15-1532 31 cm, 48 mm 4 x 4 prongs sharp

15-1533 31 cm, 25 mm 4 x 4 prongs blunt

15-1534 31 cm, 37 mm 4 x 4 prongs blunt

15-1535 31 cm, 48 mm 4 x 4 prongs blunt



BECKMANN-EATON

15-1536

32 cm, 50 mm 7 x 7 prongs sharp

Retractors For Cervical Vertebral Column



MISKIMON
15-1537 - 15-1538
15-1537 22 cm, 35 mm 7 x 7 prongs sharp
15-1538 22 cm, 35 mm 7 x 7 prongs blunt



ADSON
15-1539 - 15-1540
15-1539 19 cm, 23 mm 4 x 4 prongs sharp
15-1540 19 cm, 23 mm 4 x 4 prongs blunt



ADSON
15-1541
19 cm, 23 mm 4 x 4 prongs sharp

Retractors For Cervical Vertebral Column



NORFOLK & NORWICH
Hemilaminectomy Retractor
15-1542
22 cm, 50 mm 4 x 5 prongs blunt



GELPI
Skin Retractor
15-1543
17.5 cm

Retractors For Cervical Vertebral Column

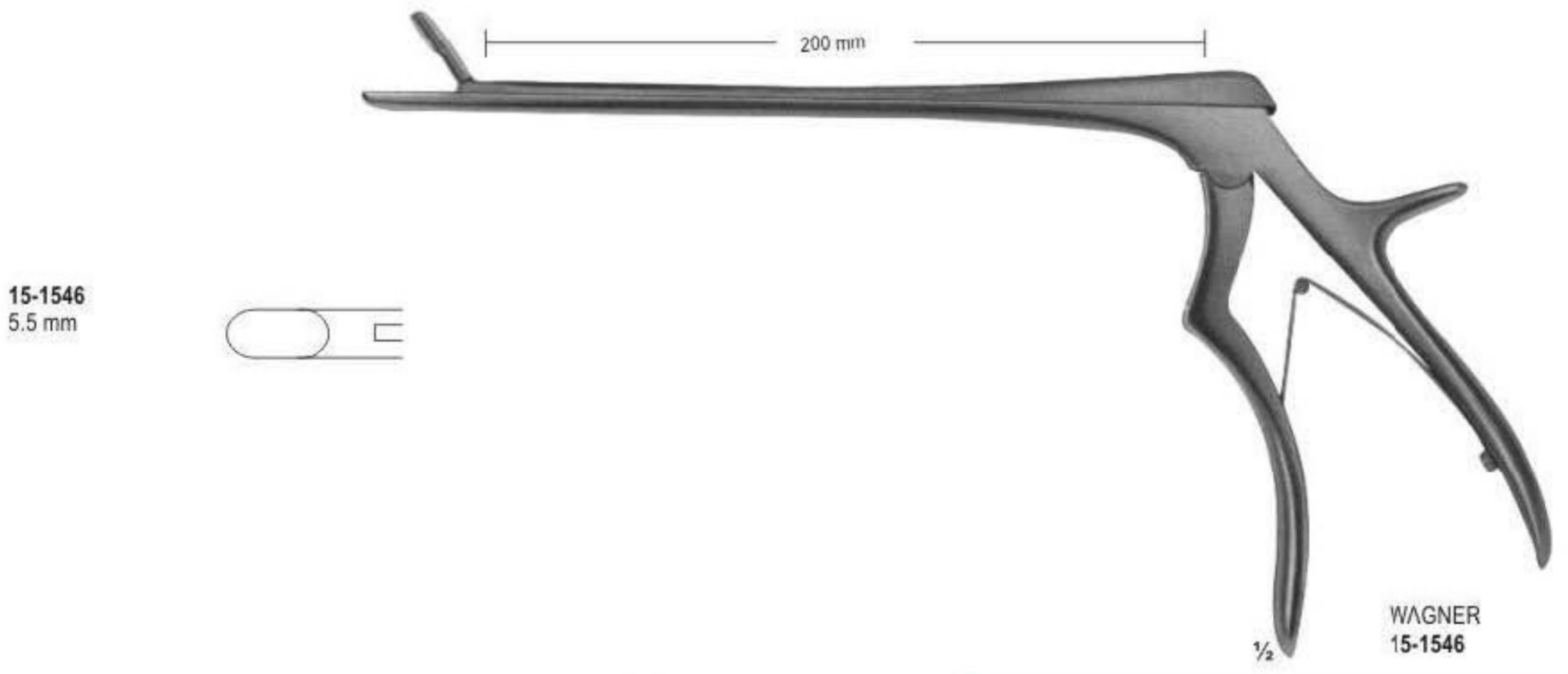
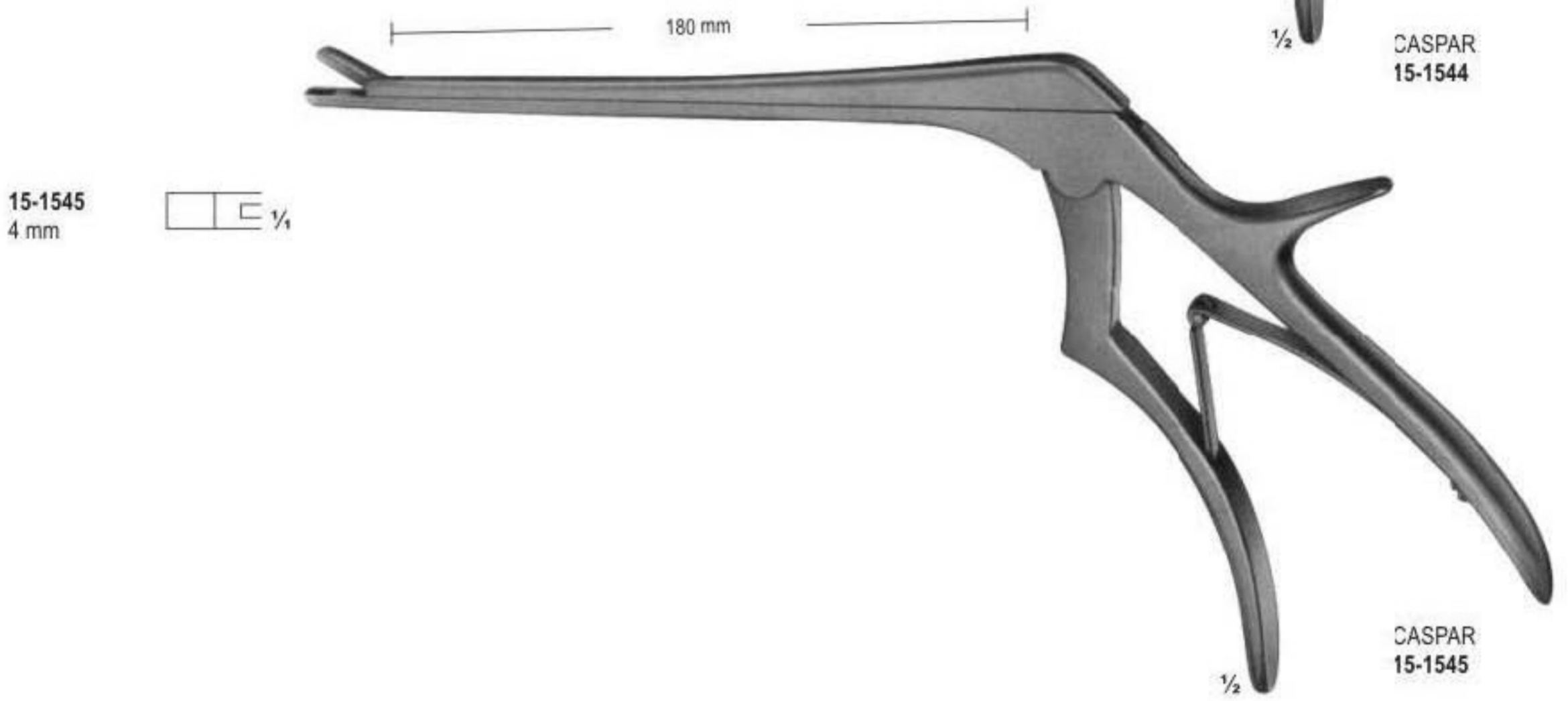
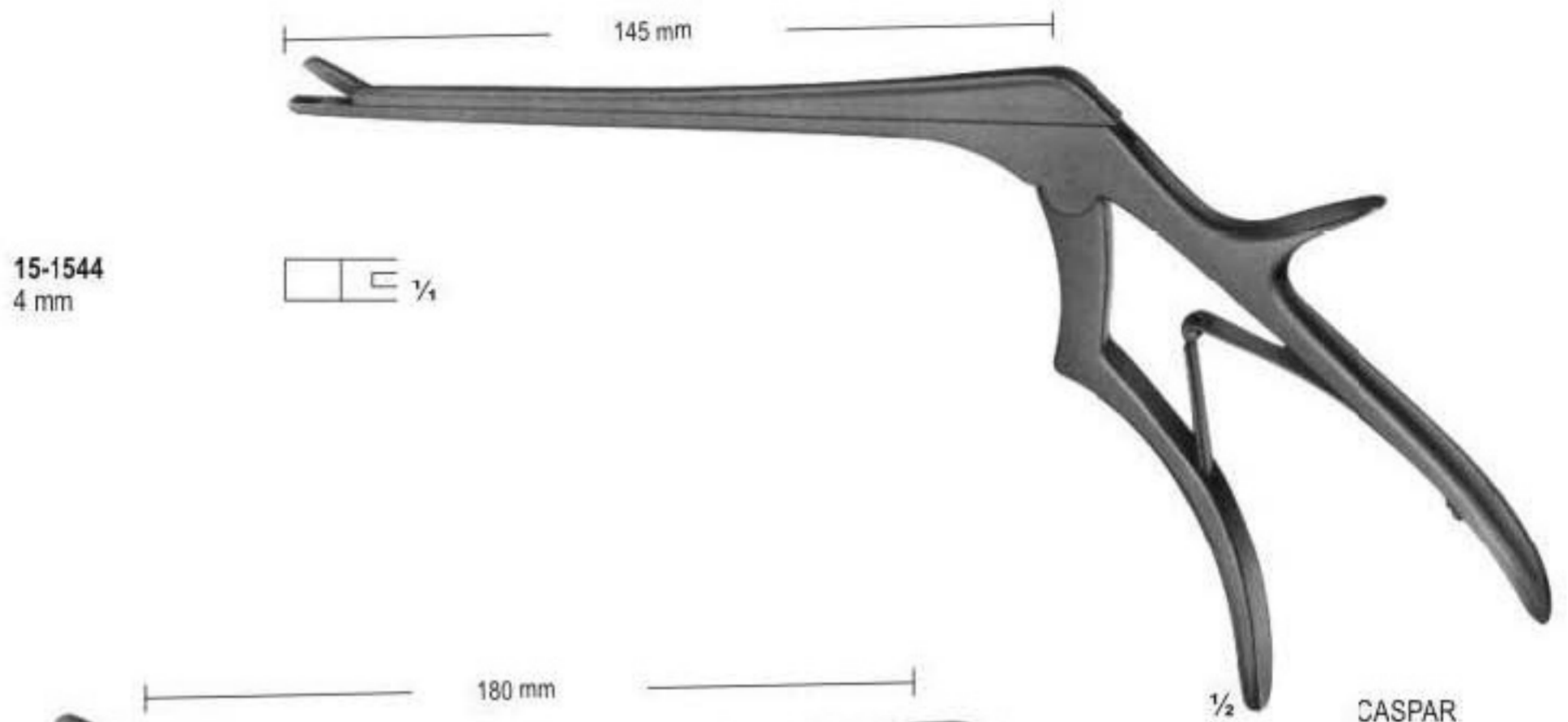

Lamina Spreaders

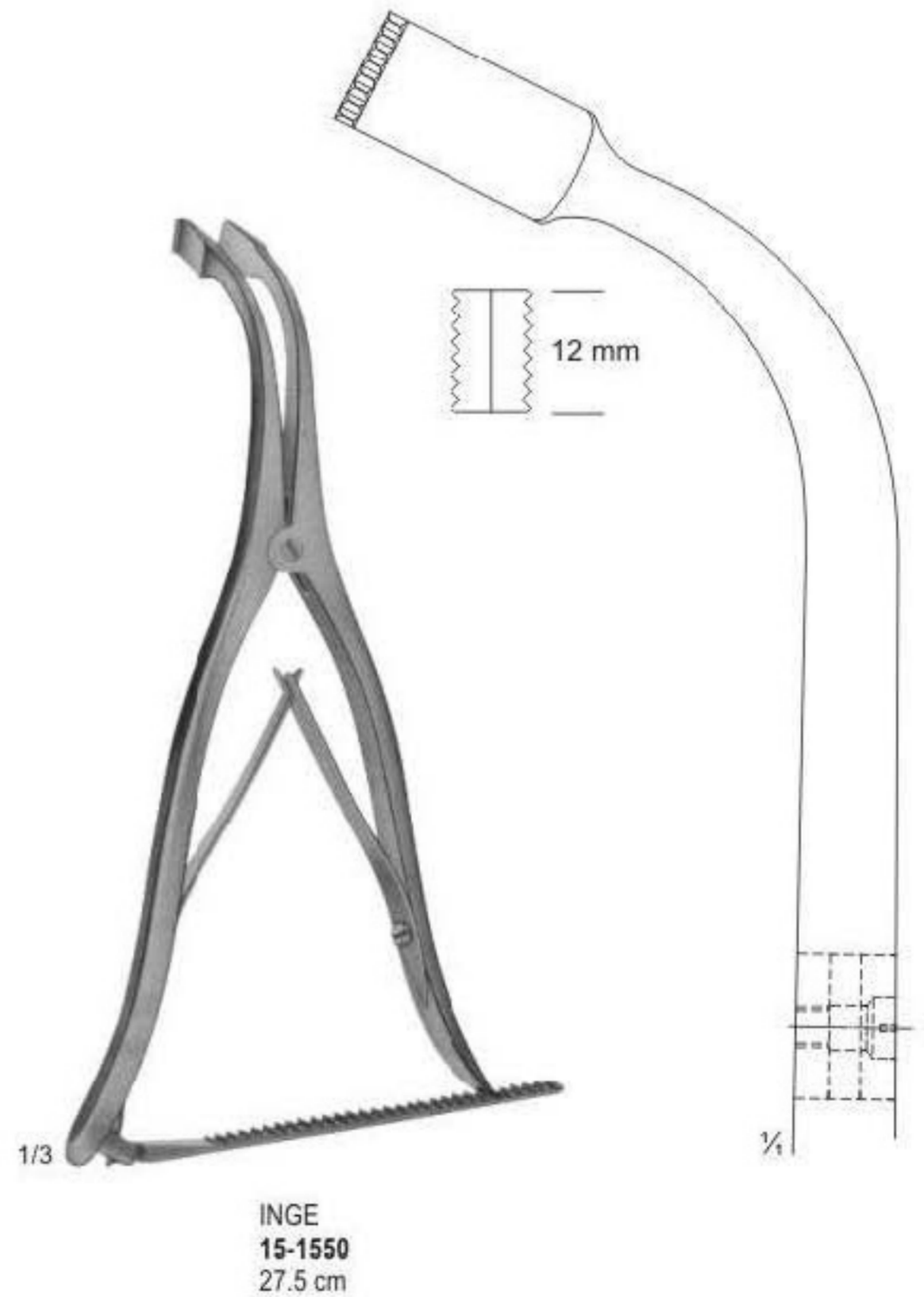
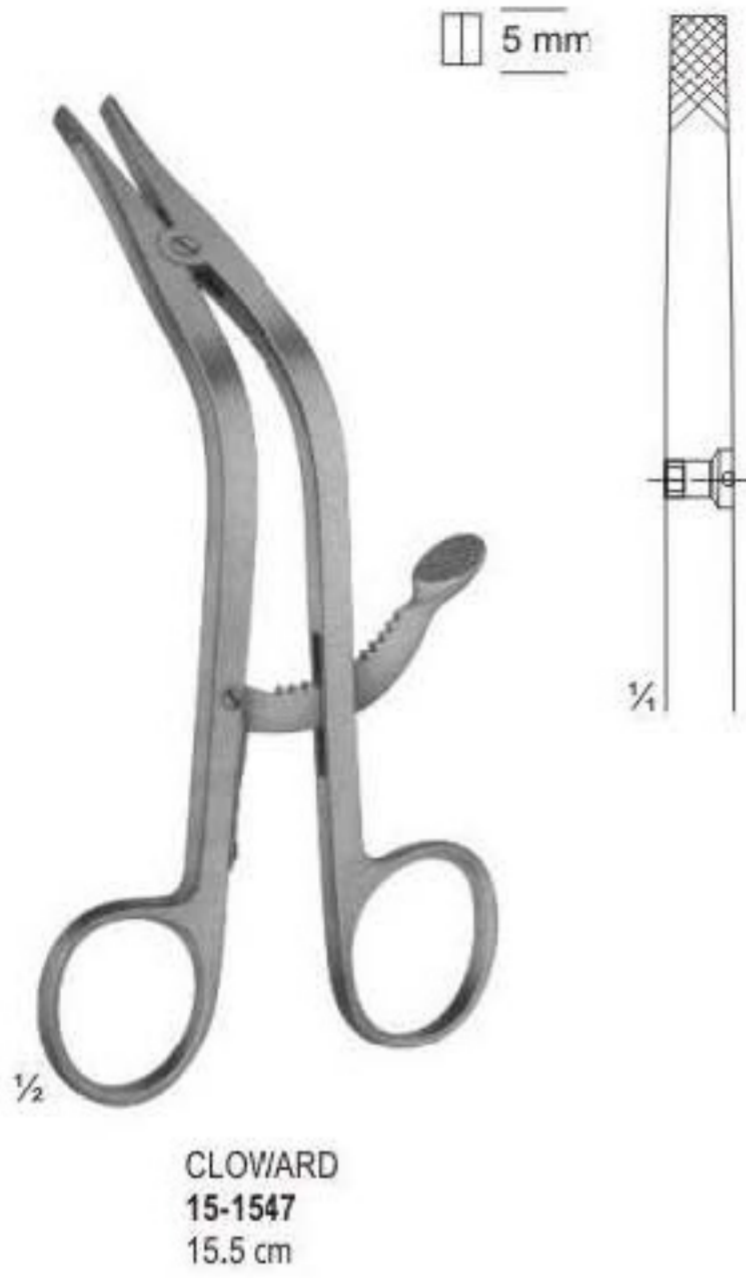

Rongeurs

- 15-1551
3 mm
- 15-1552
3.6 mm
- 15-1553
4.2 mm
- 15-1554
4.8 mm
- 15-1555
5.8 mm



WEIL-BLAKESLEY
15-1551 - 15-1555



TAKAHASHI
15-1556
3 mm

Angled positions for rongeurs

130°

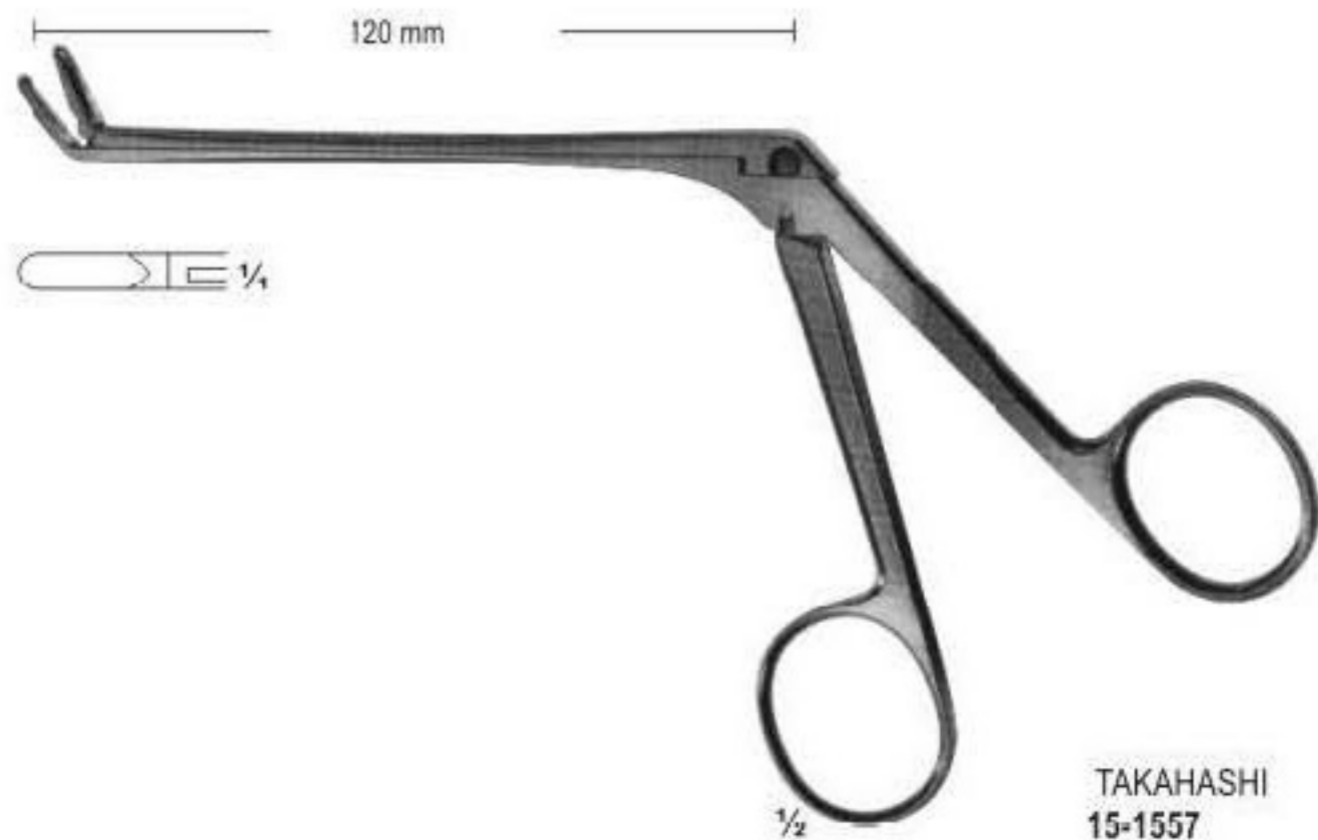

TAKAHASHI
15-1557
3 mm

Rongeurs

15-1558
2 X 10 mm

15-1559
3 X 10 mm

15-1560
4 X 10 mm

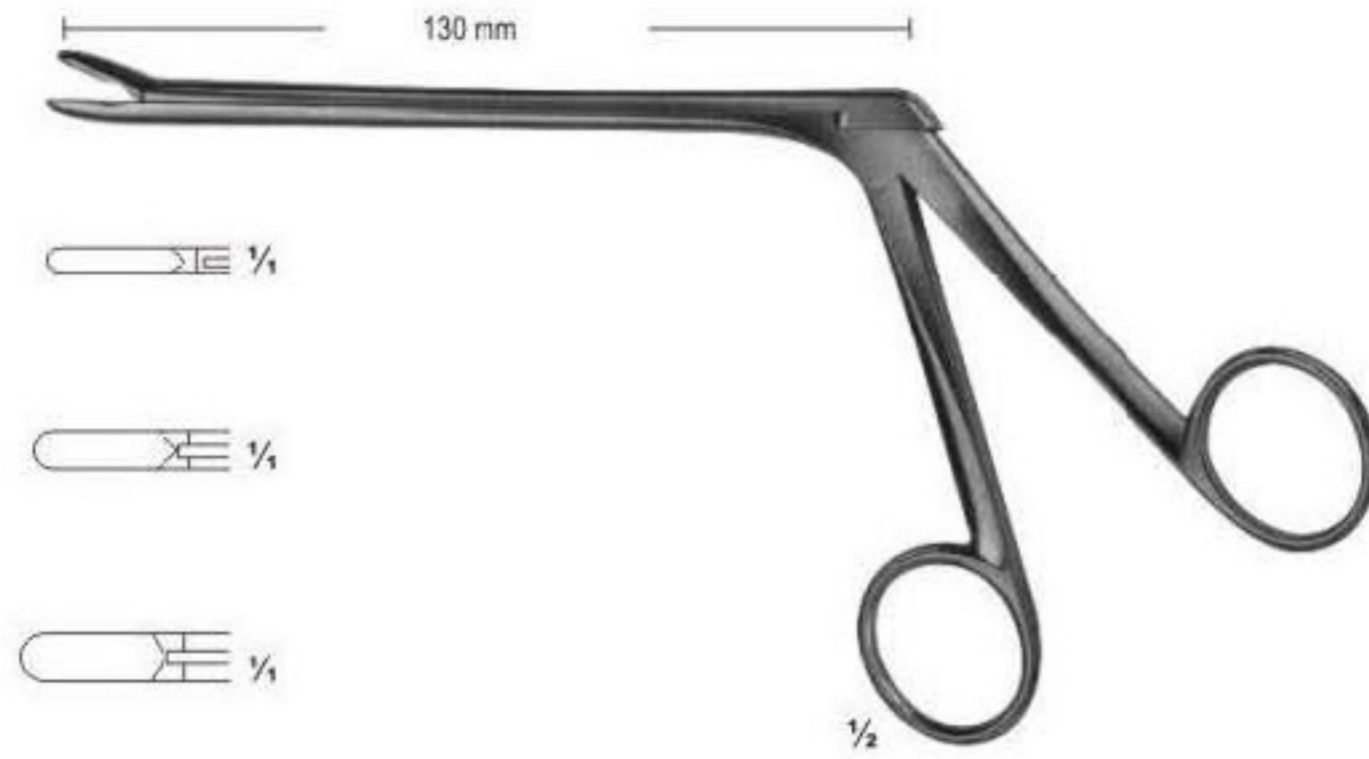

LOVE-GRUENWALD
15-1558 - 15-1560

15-1561
2 mm

15-1562
3 mm

15-1563
4 mm

15-1564
5 mm

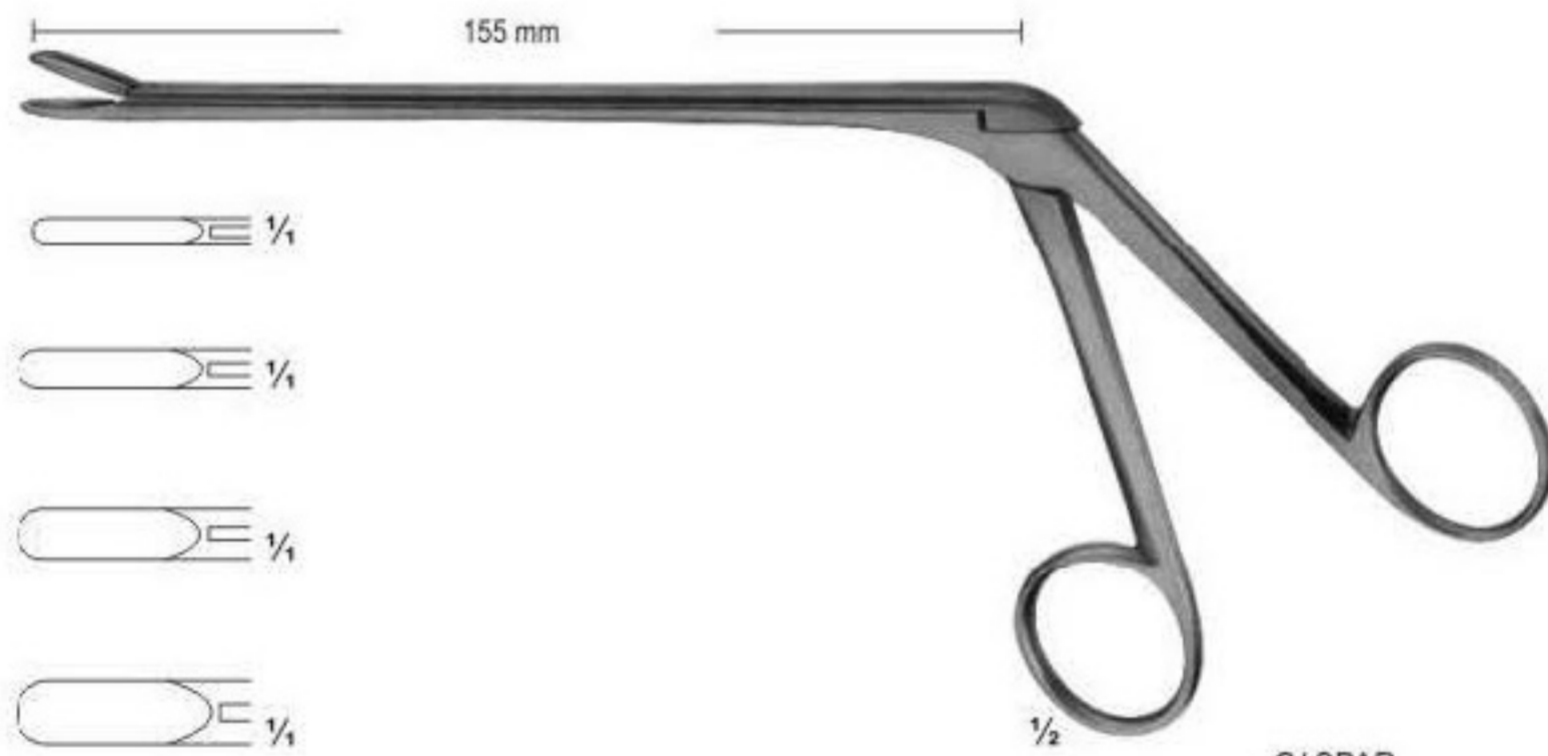

CASPAR
15-1561 - 15-1564

15-1565
2 mm

15-1566
3 mm

15-1567
4 mm

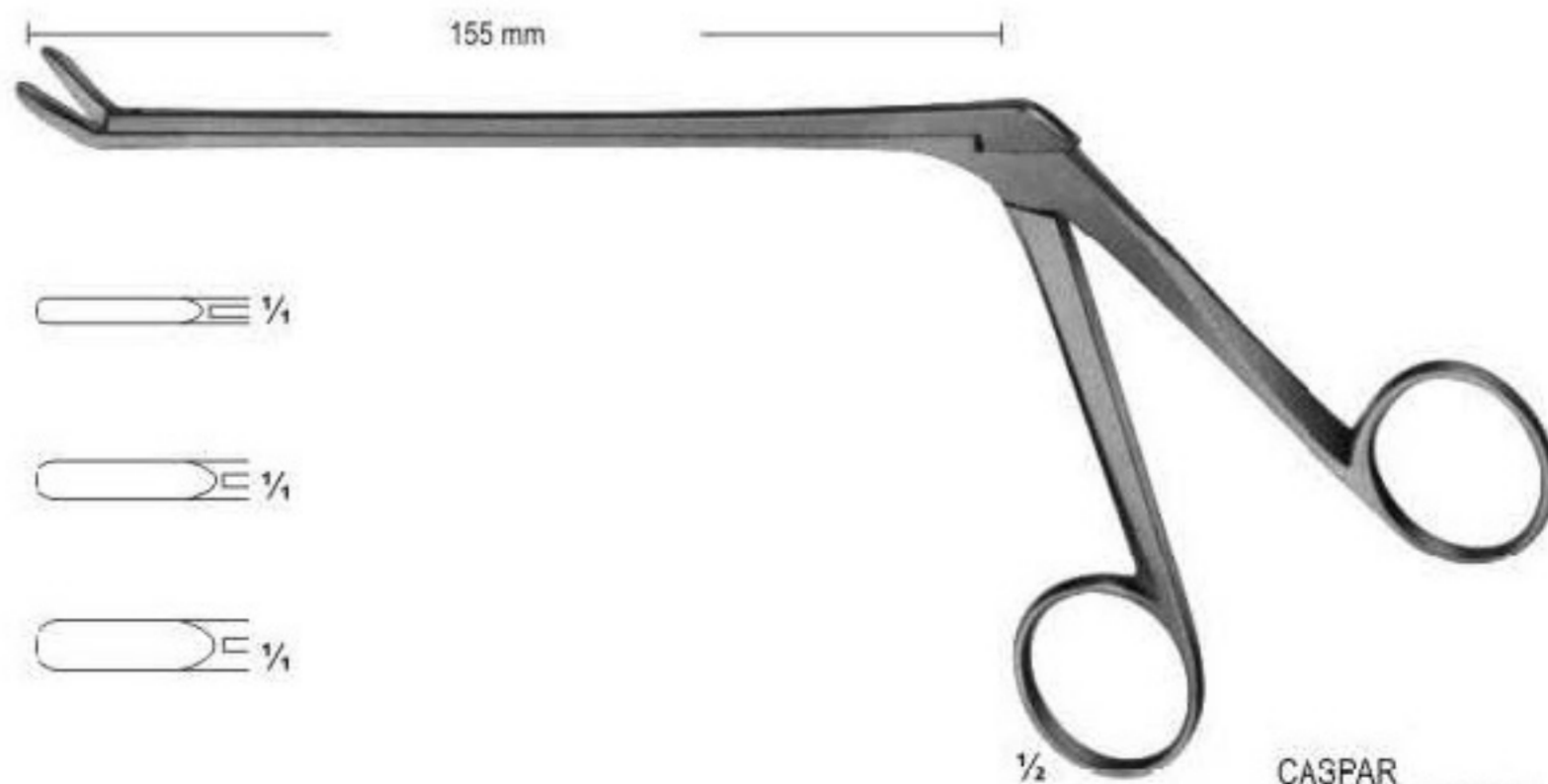

CASPAR
15-1565 - 15-1567

Rongeurs



15-1568
2 mm

15-1569
3 mm

15-1570
4 mm

CASPAR
15-1568 - 15-1570

Length of shaft 140 mm	Length of shaft 160 mm	Length of shaft 185 mm	size of jaws
15-1571	15-1576	15-1581	2 X12 mm
15-1572	15-1577	15-1582	3 X12 mm
15-1573	15-1578	15-1583	4 X14 mm
15-1574	15-1579	15-1584	5 X14 mm
15-1575	15-1580	15-1585	6 X16 mm

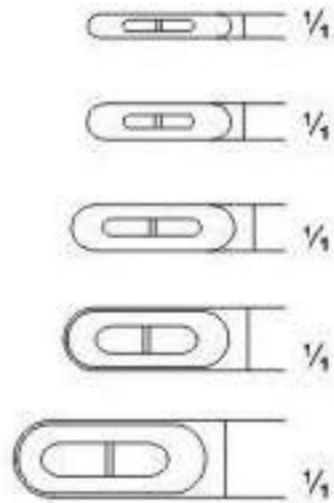

CASPAR
15-1571 - 15-1585

Length of shaft 140 mm	Length of shaft 160 mm	Length of shaft 185 mm	size of jaws
15-1586	15-1589	15-1592	3 X12 mm
15-1587	15-1590	15-1593	4 X14 mm
15-1588	15-1591	15-1594	5 X14 mm

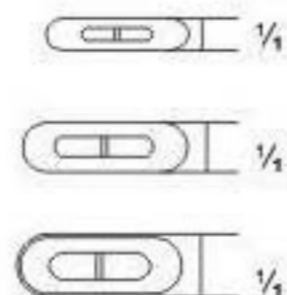

CASPAR
15-1586 - 15-1594

Rongeurs

Length of shaft 140 mm	Length of shaft 160 mm	Length of shaft 185 mm	size of jaws
15-1595	15-1597	15-1599	3 X12 mm
15-1596	15-1598	15-1600	4 X14 mm



CUSHING
15-1595 - 15-1600

CUSHING
15-1601
2 X 10 mm

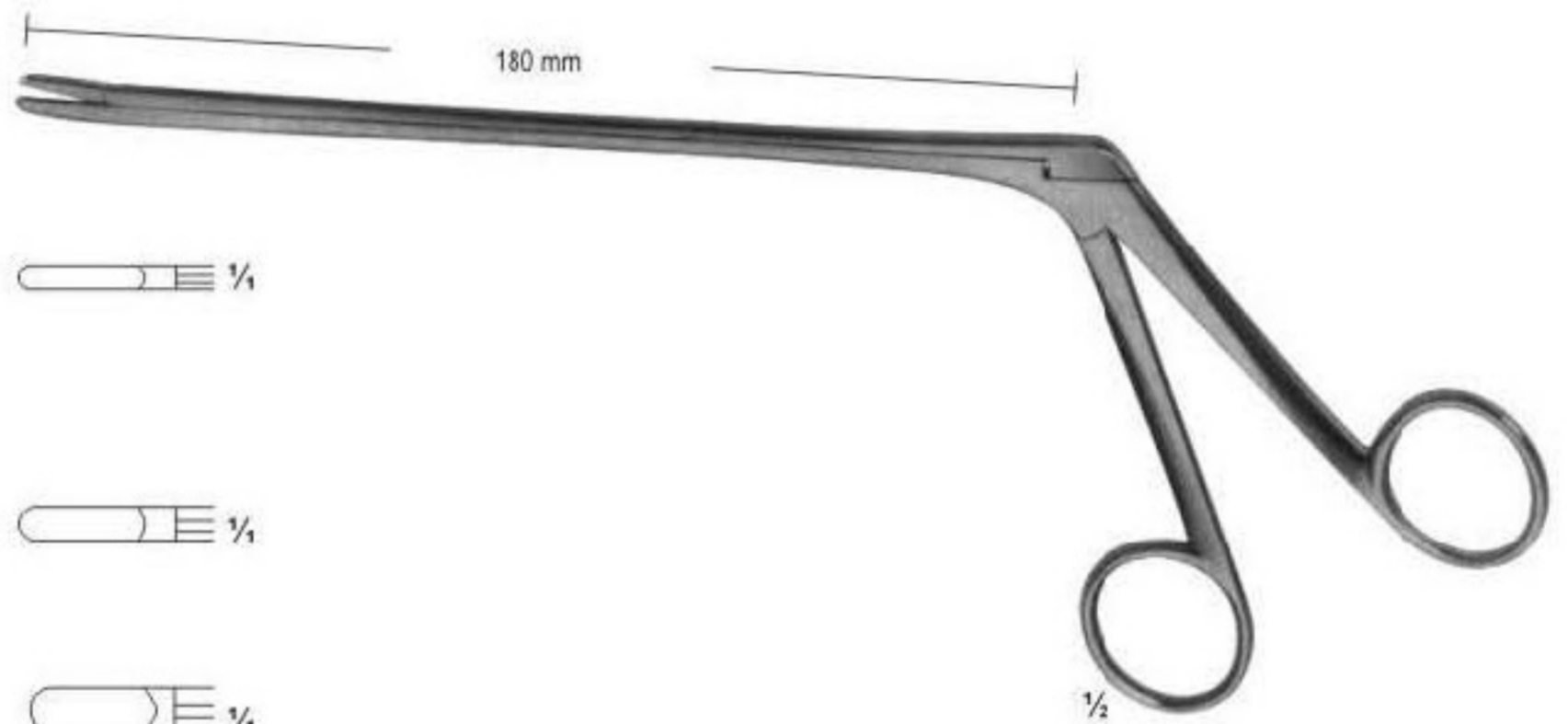

LOVE-GRUENWALD
15-1601 - 15-1603

LOVE-GRUENWALD
15-1602
3 X 10 mm

SPURLING
15-1603
4 X 10 mm

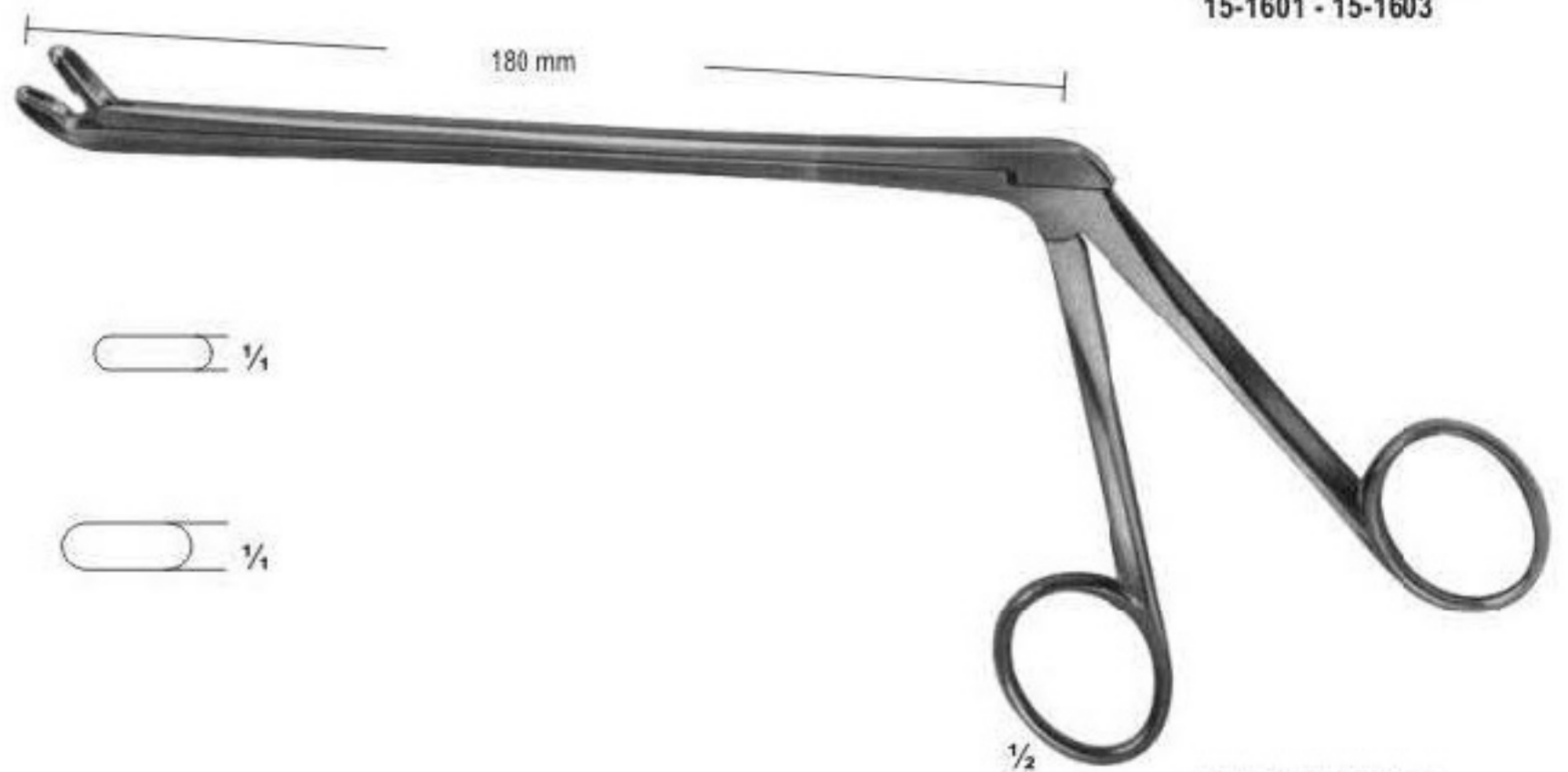

LOVE-GRUENWALD
15-1604 - 15-1605

LOVE-GRUENWALD
15-1604
3 X 10 mm

SPURLING
15-1605
4 X 10 mm

Rongeurs

LANDOLT
15-1606
2 X 10 cm

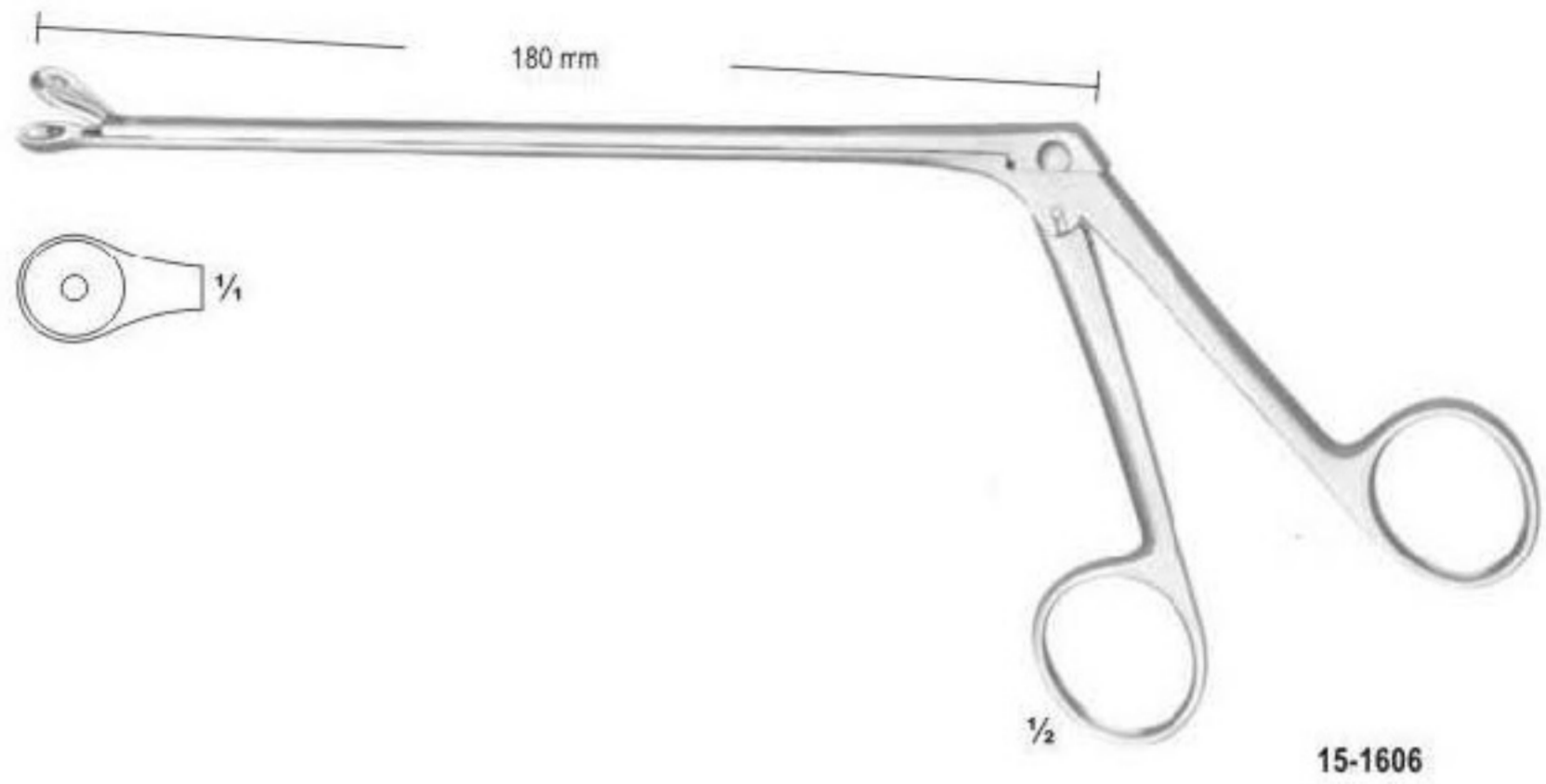

15-1607
7 mm

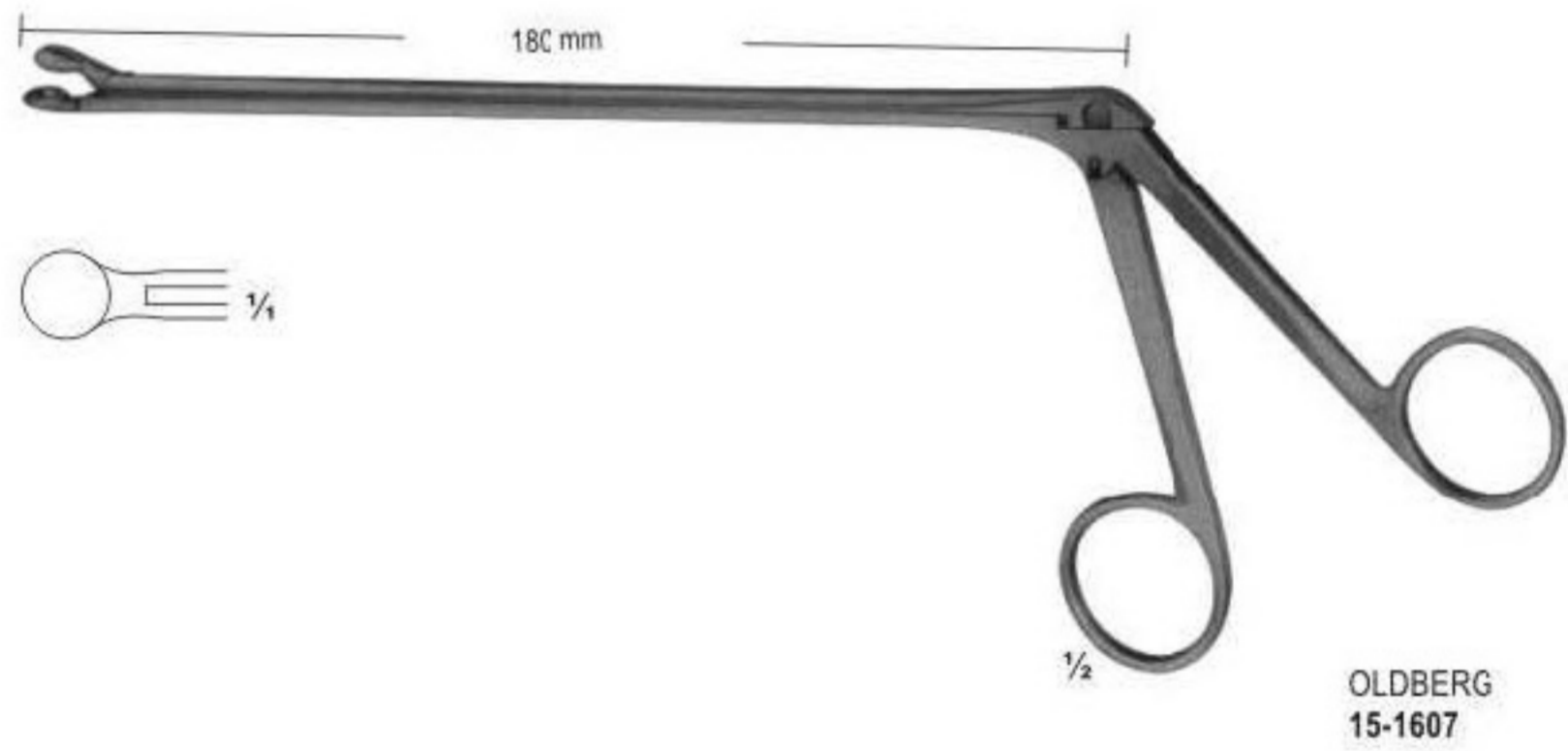

YASARGIL
15-1608
2.2 mm

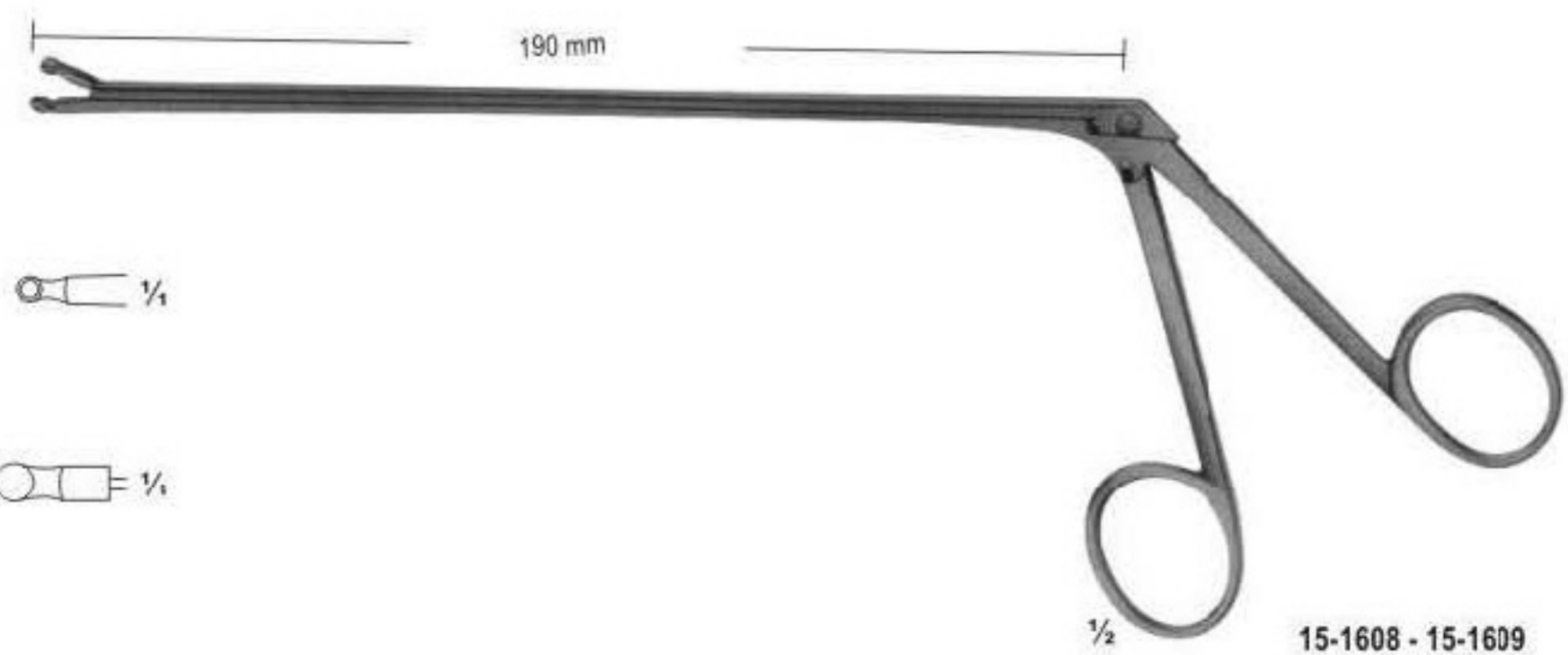

YASARGIL
15-1609
3.5 mm

Rongeurs



15-1610 - 15-1636

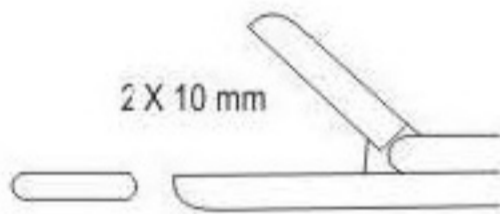

CUSHING
15-1610 12 cm
15-1611 15 cm
15-1612 18 cm
Straight

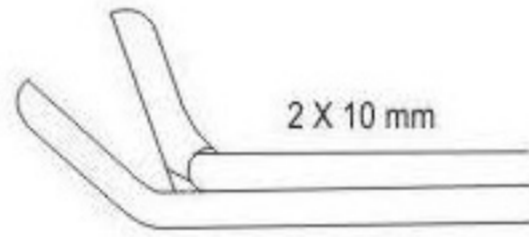

CUSHING
15-1613 12 cm
15-1614 15 cm
15-1615 18 cm
Upwards

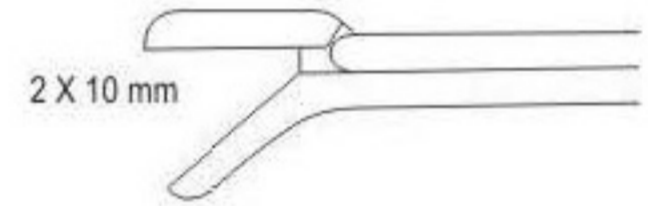

CUSHING
15-1616 12 cm
15-1617 15 cm
15-1618 18 cm
Downwards

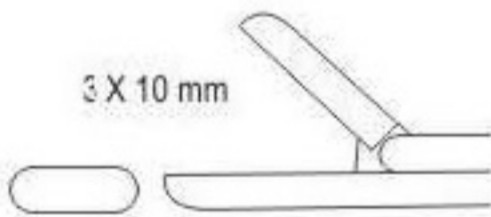

LOVE-GRUENWALD
15-1619 12 cm
15-1620 15 cm
15-1621 18 cm
Straight



LOVE-GRJENWALD
15-1622 12 cm
15-1623 15 cm
15-1624 18 cm
Upwards

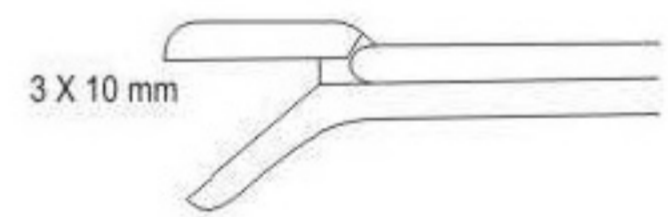

LOVE-GRUENWALD
15-1625 12 cm
15-1626 15 cm
15-1627 18 cm
Downwards

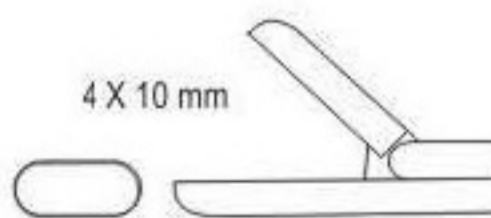

SPURLING
15-1628 12 cm
15-1629 15 cm
15-1630 18 cm
Straight

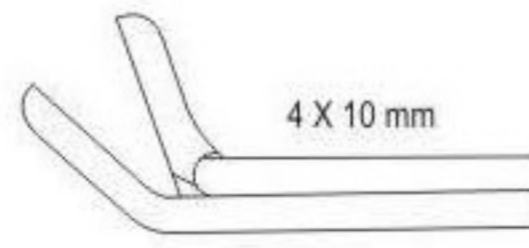

SPURLING
15-1631 12 cm
15-1632 15 cm
15-1633 18 cm
Upwards

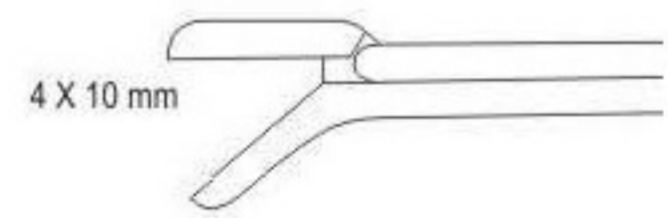

SPURLING
15-1634 12 cm
15-1635 15 cm
15-1636 18 cm
Downwards

Punches

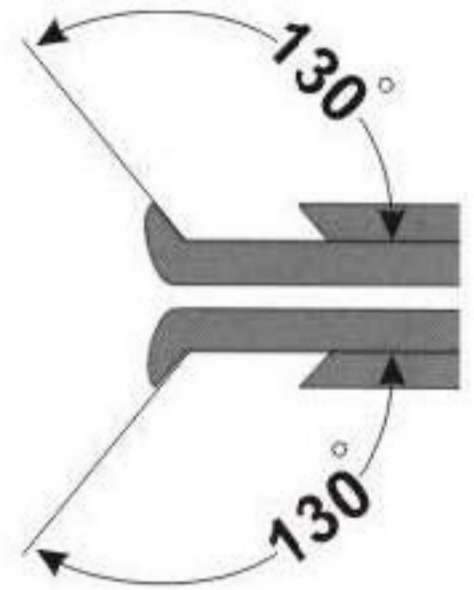
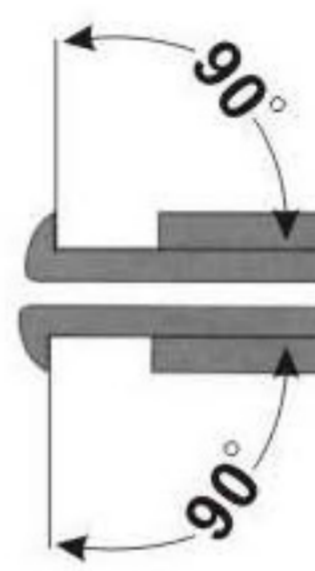
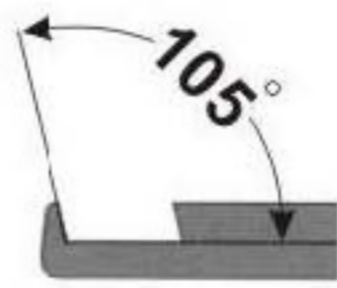

90° upwards cutting

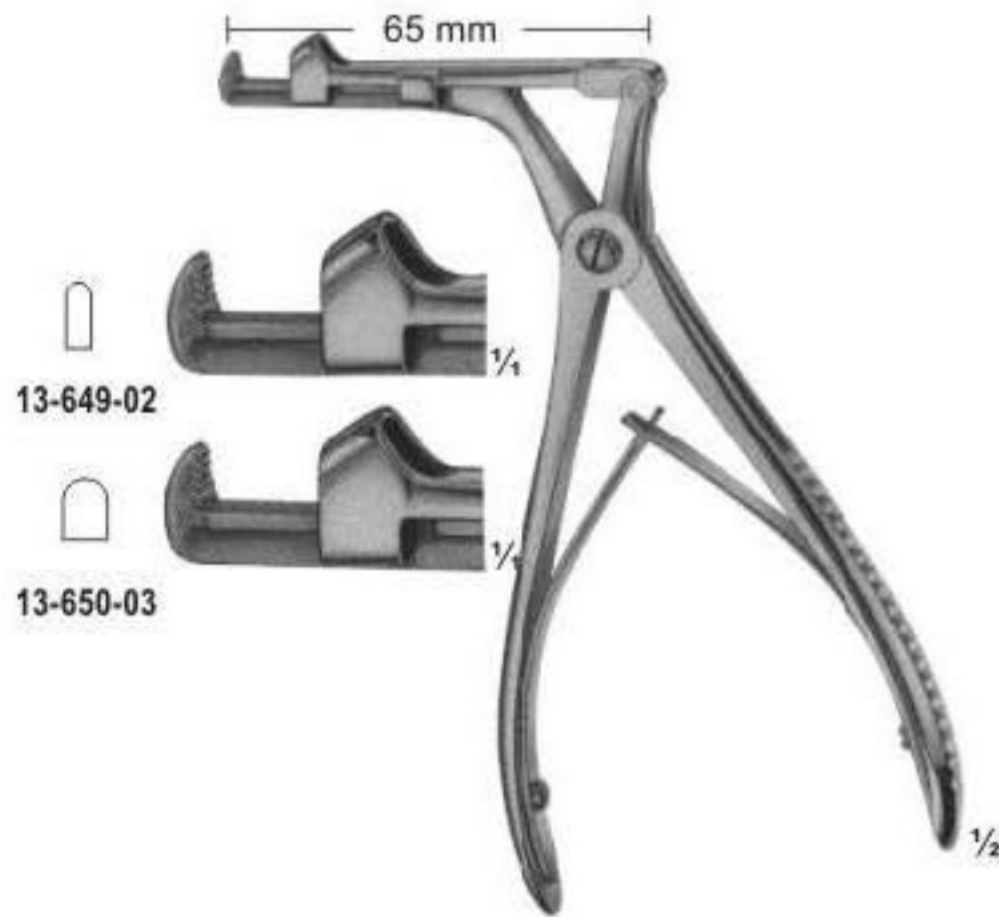

CITELLI
15-1637 - 15-1638
15-1637 2 mm
15-1638 3.5 mm

90° upwards cutting

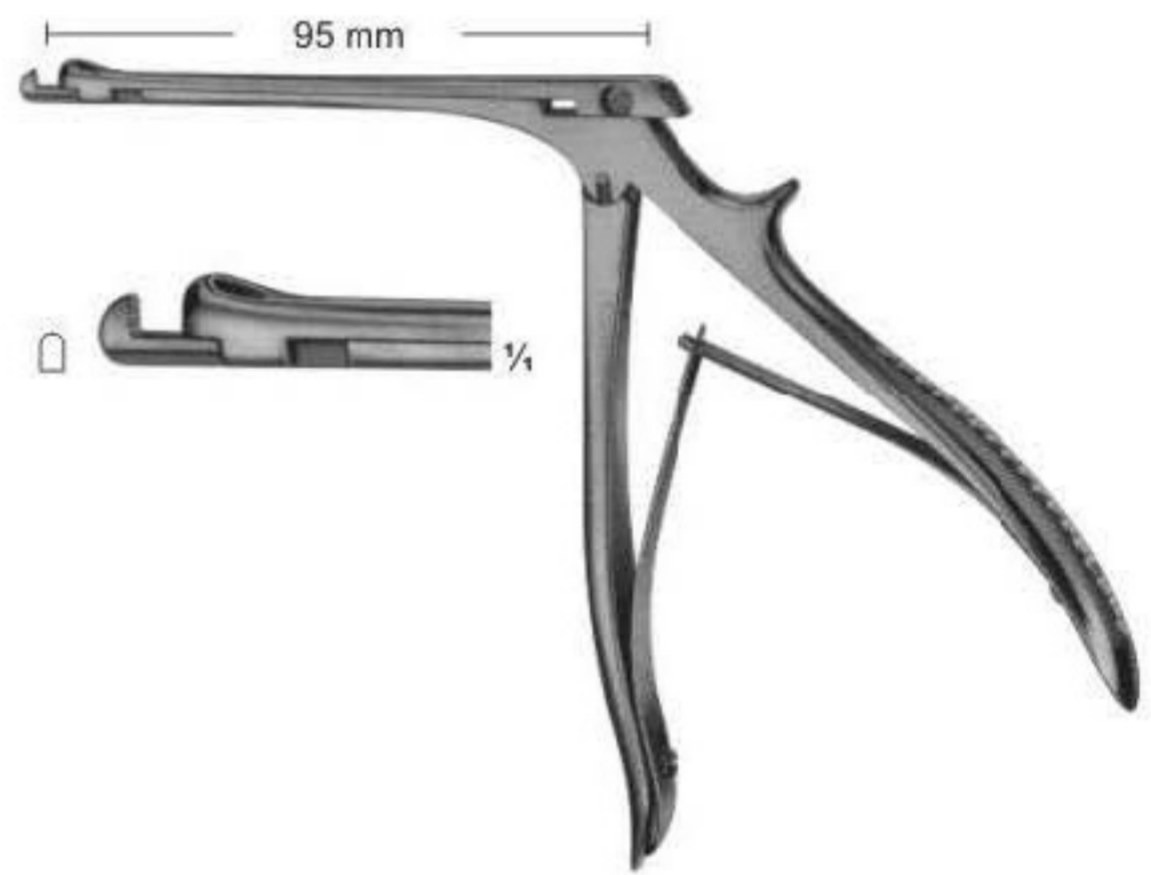

CITELLI-BEYER
15-1639
1.8 mm

Punches

90° upwards cutting

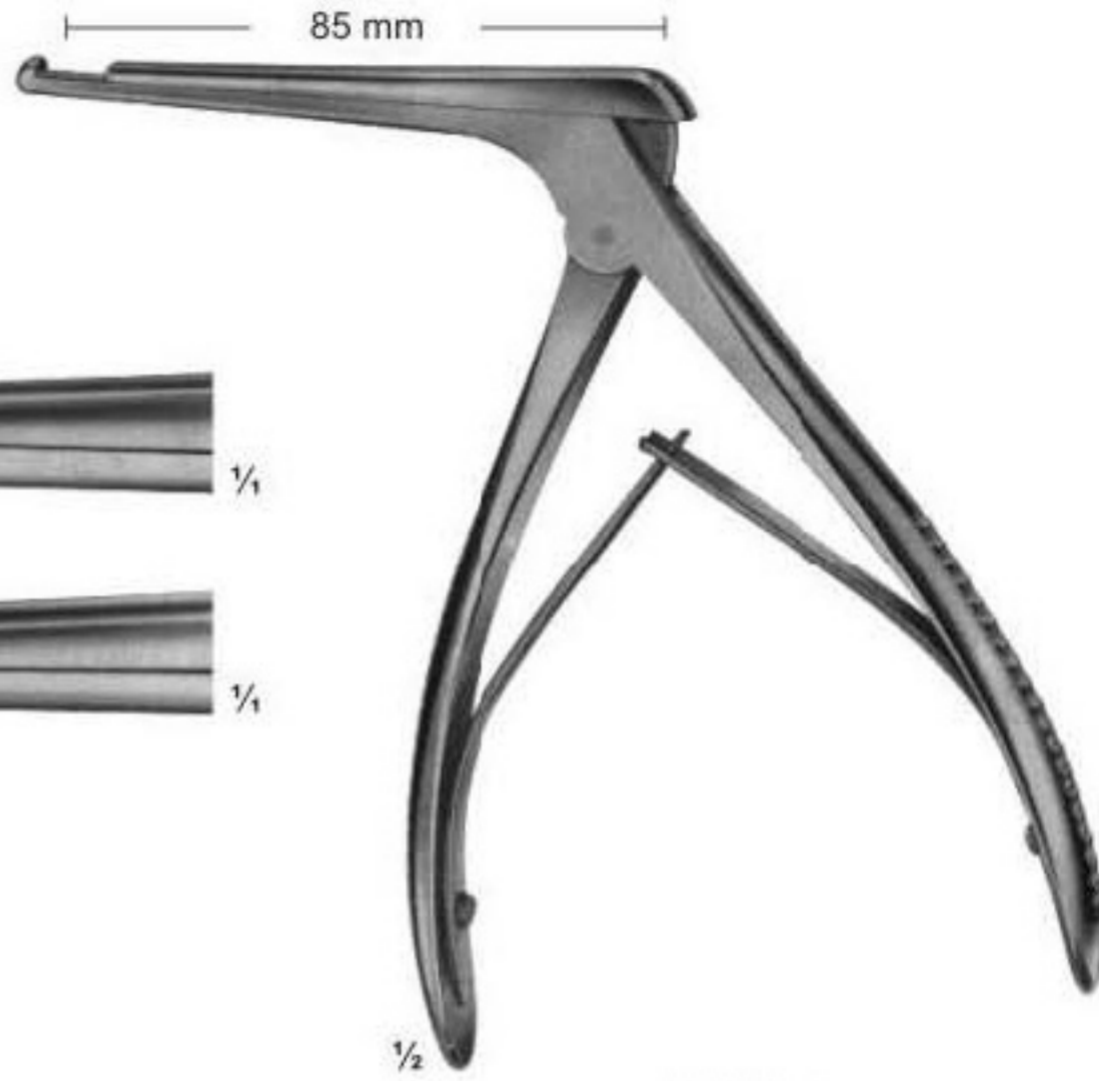

15-1640
4 mm



15-1641
5 mm



KERRISON
15-1640 - 15-1641

90° upwards cutting

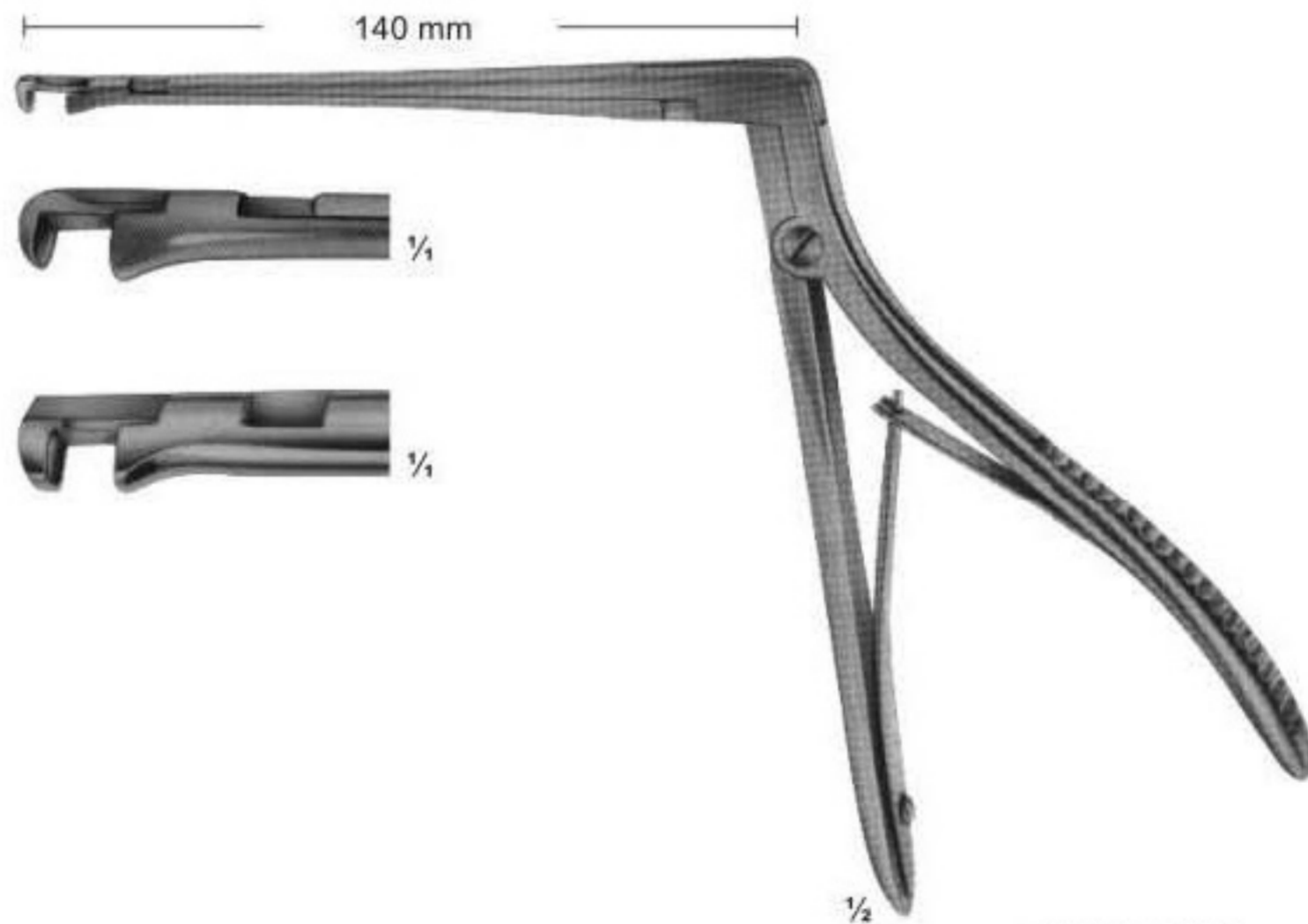

15-1642
3.3 mm



15-1643
4 mm



HAJEK-KOFLER
15-1642 - 15-1643

Punches

130° upwards cutting

- 15-1644
1 mm 
- 15-1645
2 mm 
- 15-1646
3 mm 
- 15-1647
4 mm 
- 15-1648
5 mm 

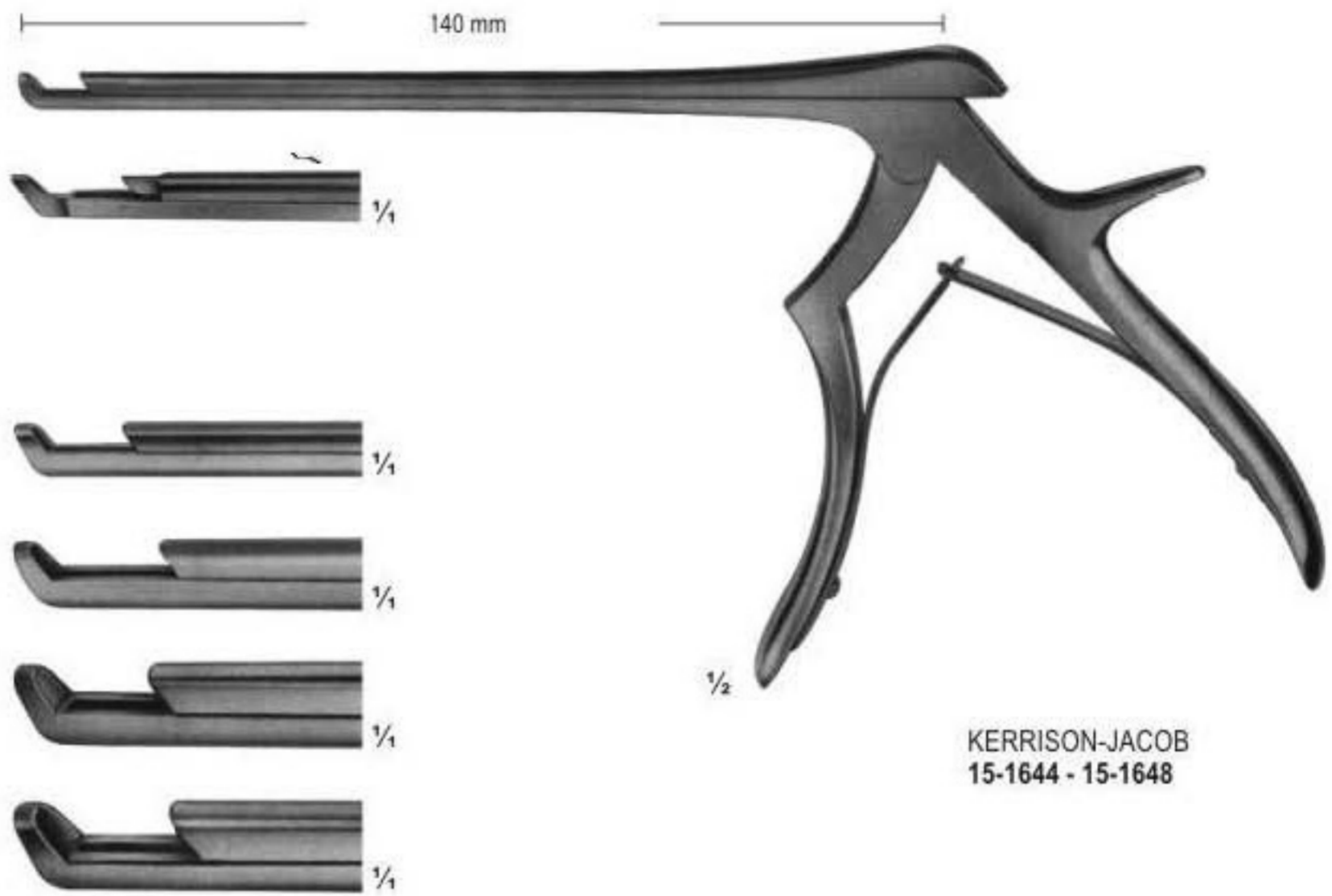

KERRISON-JACOB
15-1644 - 15-1648

90° upwards cutting

- 15-1649
1 mm 
- 15-1650
2 mm 
- FERRIS-SMITH-KERRISON
- 15-1651
3 mm 
- 15-1652
4 mm 
- 15-1653
5 mm 

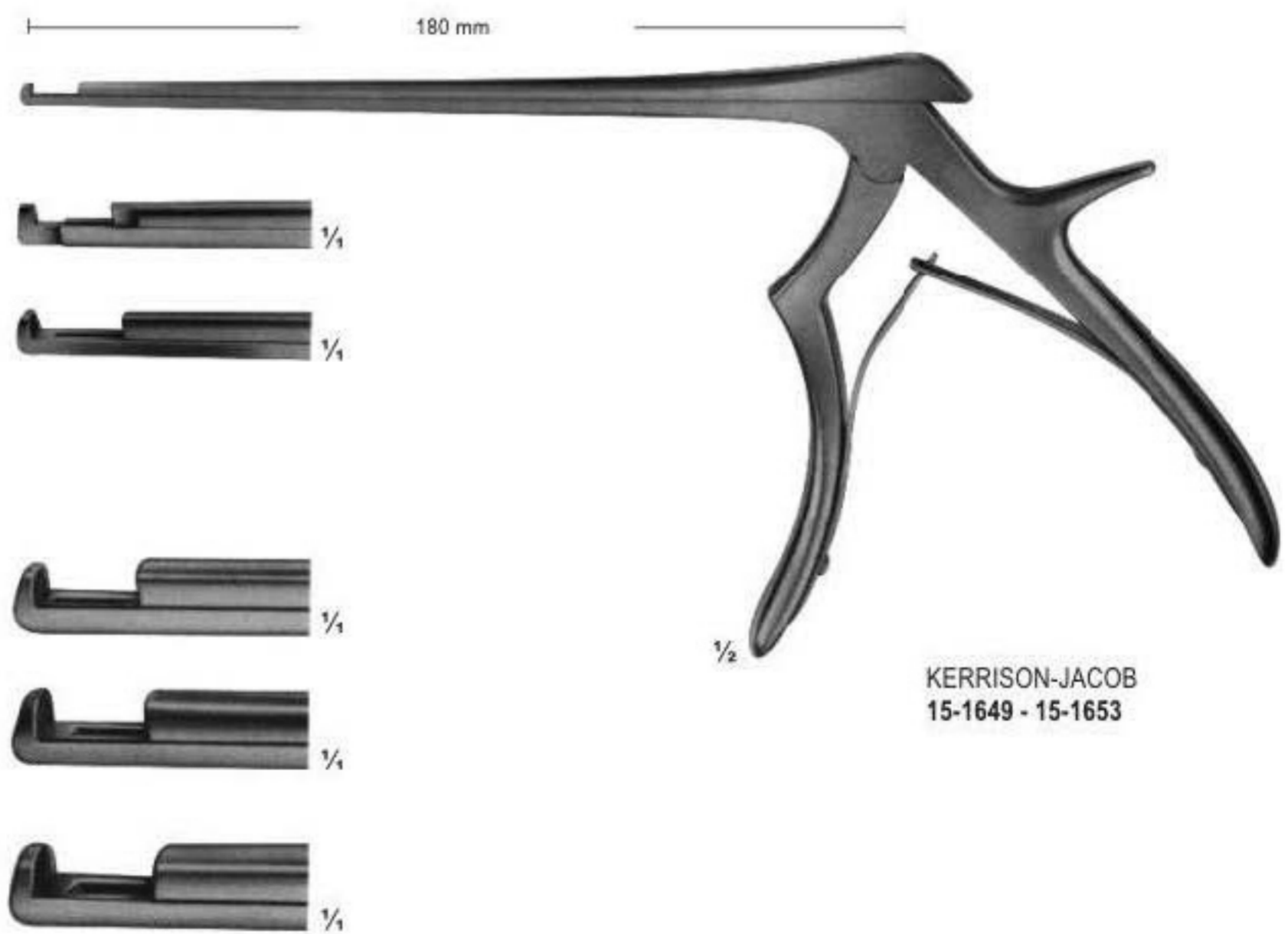

KERRISON-JACOB
15-1649 - 15-1653

Page 377-404



- Elevators, Graft Packers, Burrs
- Mouth Gags
- Lip & Cheek Retractor
- Tongue Depressors
- Soft Tissue Retractors
- Ramus, Chin & Channel Retractors
- Clip Applying Forceps - Suture Sets
- Periosteal Elevators
- Orbital Hook
- Disimpaction Forceps
- Elevators, Osteotomes, Wire Pushers
- Cleft Palate Instruments
- Cleft Palate Needles, Tonsil Knife
- Tonsil Dissectors & Gauze Packers
- Tonsil Snares
- Broncho-Esophagoscopy Forceps
- Exchangable Tips
- Blood Lancets & Laryngeal Mirrors
- Wound & Tracheal Hooks & Dilators
- Tracheal Tubes With Inner Tubes



Tonsil Dissectors And Gauze Packers



HENKE
16-1001
tonsil dissector
23 cm



HENKE
16-1002
tonsil dissector
23 cm



HURD
16-1003
tonsil dissector
22.5 cm

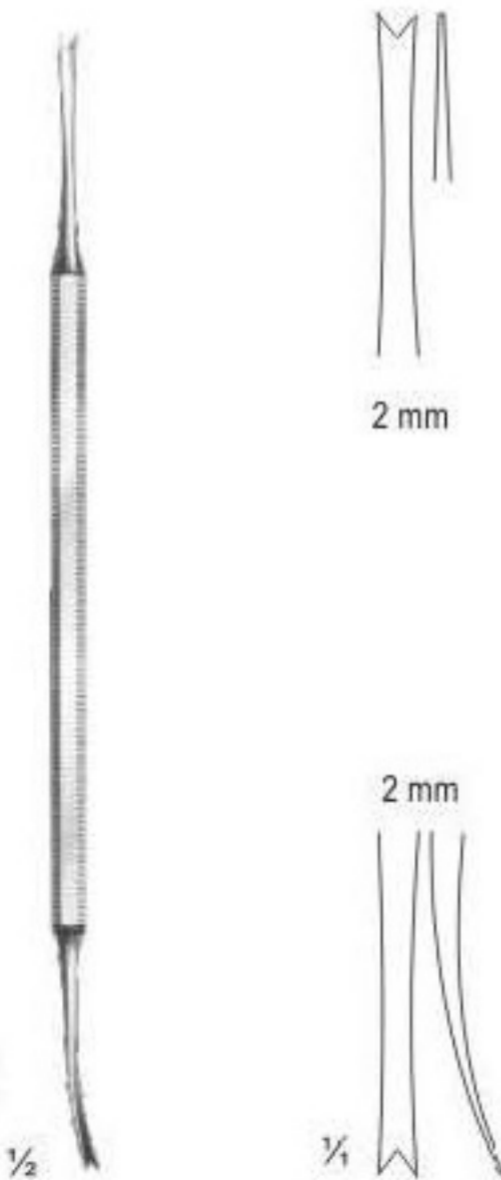

LUNIATSCHEK
16-1004
17.5 cm



2 mm

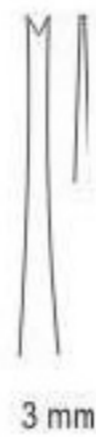

3 mm

2 mm

2 mm



1/4

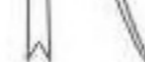

1/4

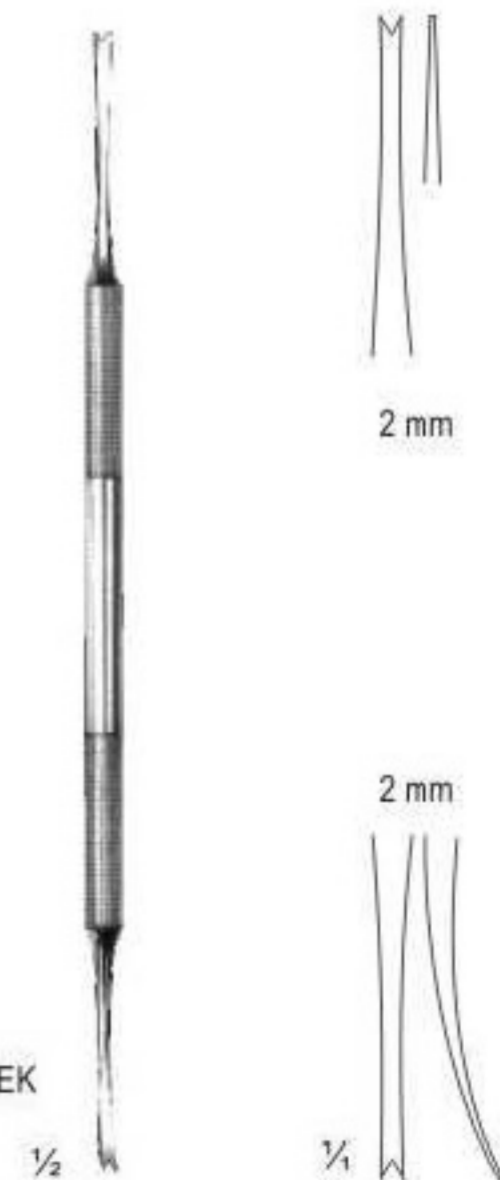

LUNIATSCHEK
16-1005
17.5 cm



2 mm

2 mm



1/4

Broncho-Esophagoscopy Forceps

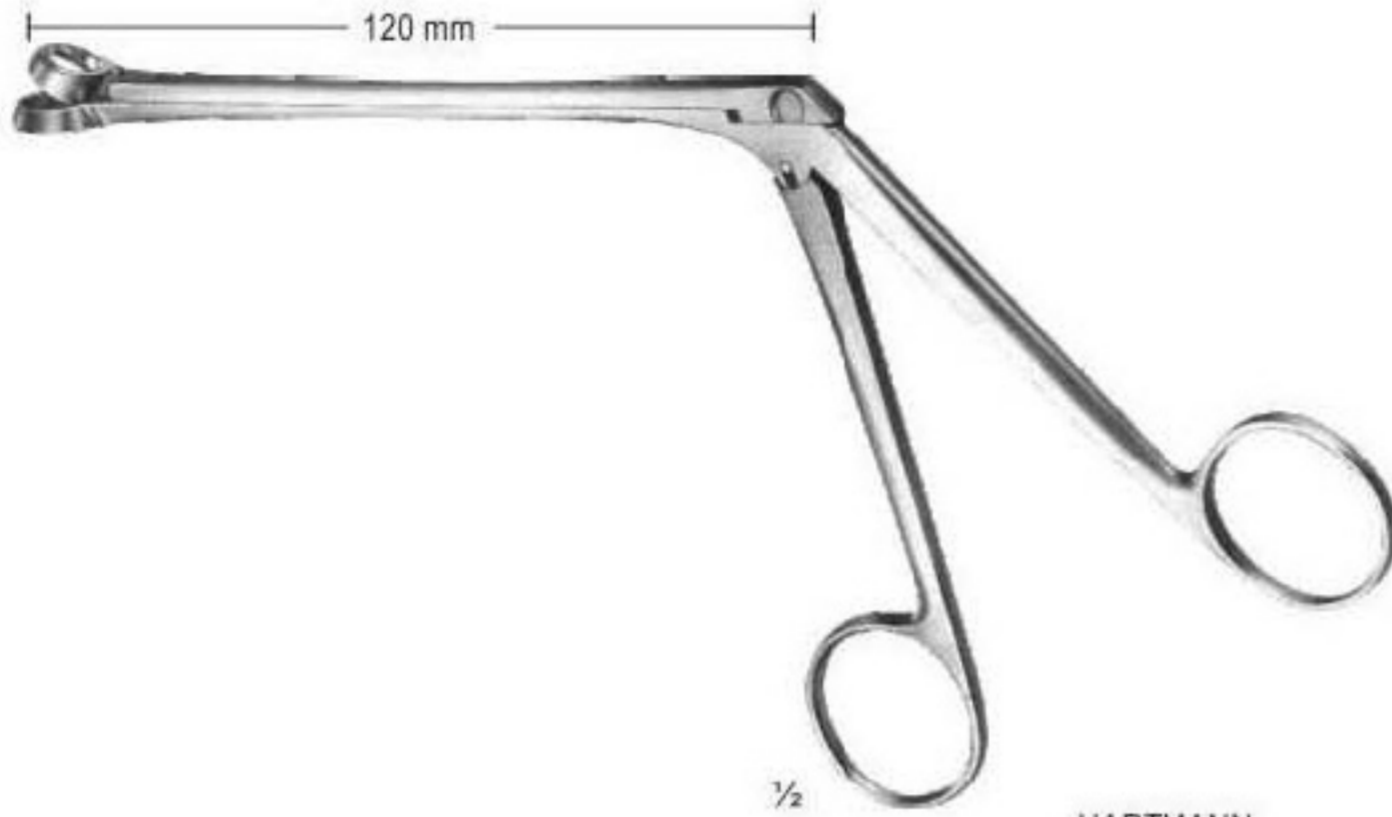

HARTMANN
16-1006 - 16-1007
Tonsil Punchthrough-cutting

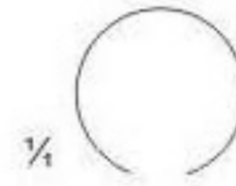

16-1006
cut
13 mm Ø

shaft length
120 mm Ø



16-1007
cut
15 mm Ø

shaft length
120 mm Ø



BRÜNINGS
16-1008 - 16-1010
for handle **16-1010**

16-1008 22 cm
16-1009 32 cm
16-1010 41 cm



HUBER
16-1011
for INTERCHANGEABLE
16-1011



BRÜNINGS
16-1012
18 cm
for handle **16-1012**

Elevators, Graft Packers, Burrs

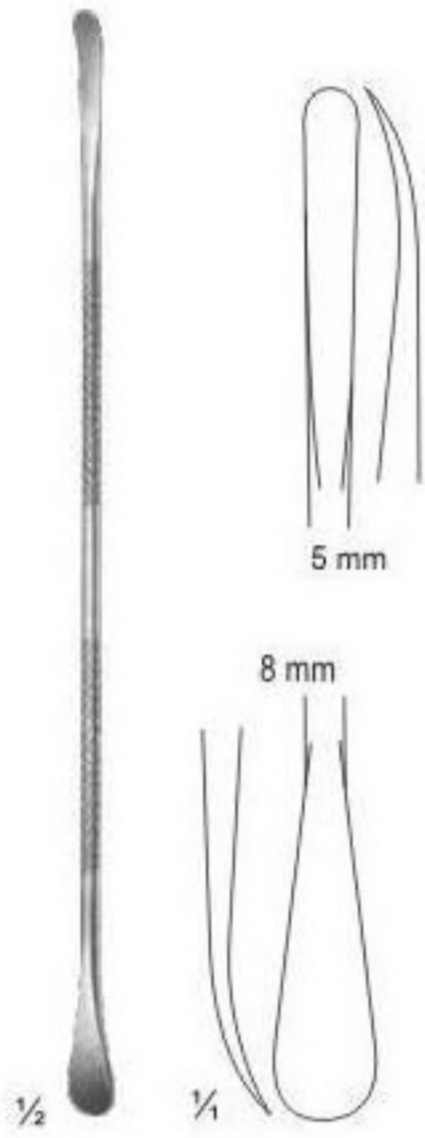

TERRY
16-1013
17 cm
For Elevation of
Alveolar Flaps

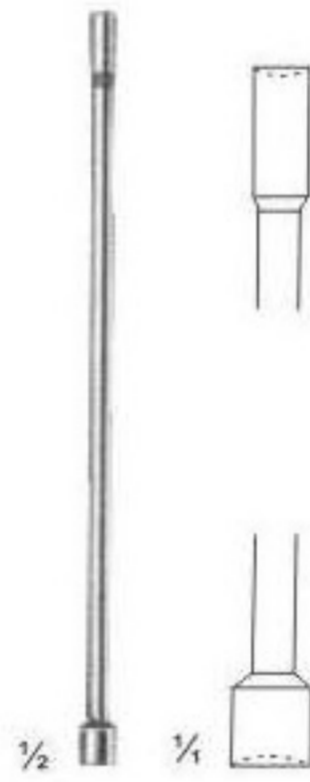

TERRY
16-1014
11.5 cm



TERRY
16-1015
13 cm



TERRY
16-1016
18 cm



TERRY
16-1017 - 16-1019
for vertical cuts in the
buccal aspect of the
mandibule



16-1017
4.5 cm
working length
10 mm



16-1018
6.5 cm
working length
22 mm



16-1019
6.5 cm
working length
35 mm

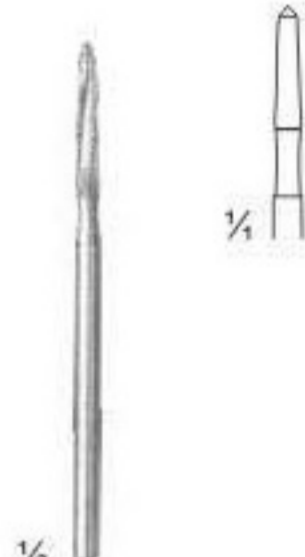

16-1020
8 cm
working length
10 mm

Clip Applying Forceps - Suture Set



1/2

JURASZ
16-1021 - 16-1024
23 cm



1/4

Fig. 1
16-1021



1/4

Fig. 2
16-1022



1/4

Fig. 3
16-1023



1/4

Fig. 4
16-1024

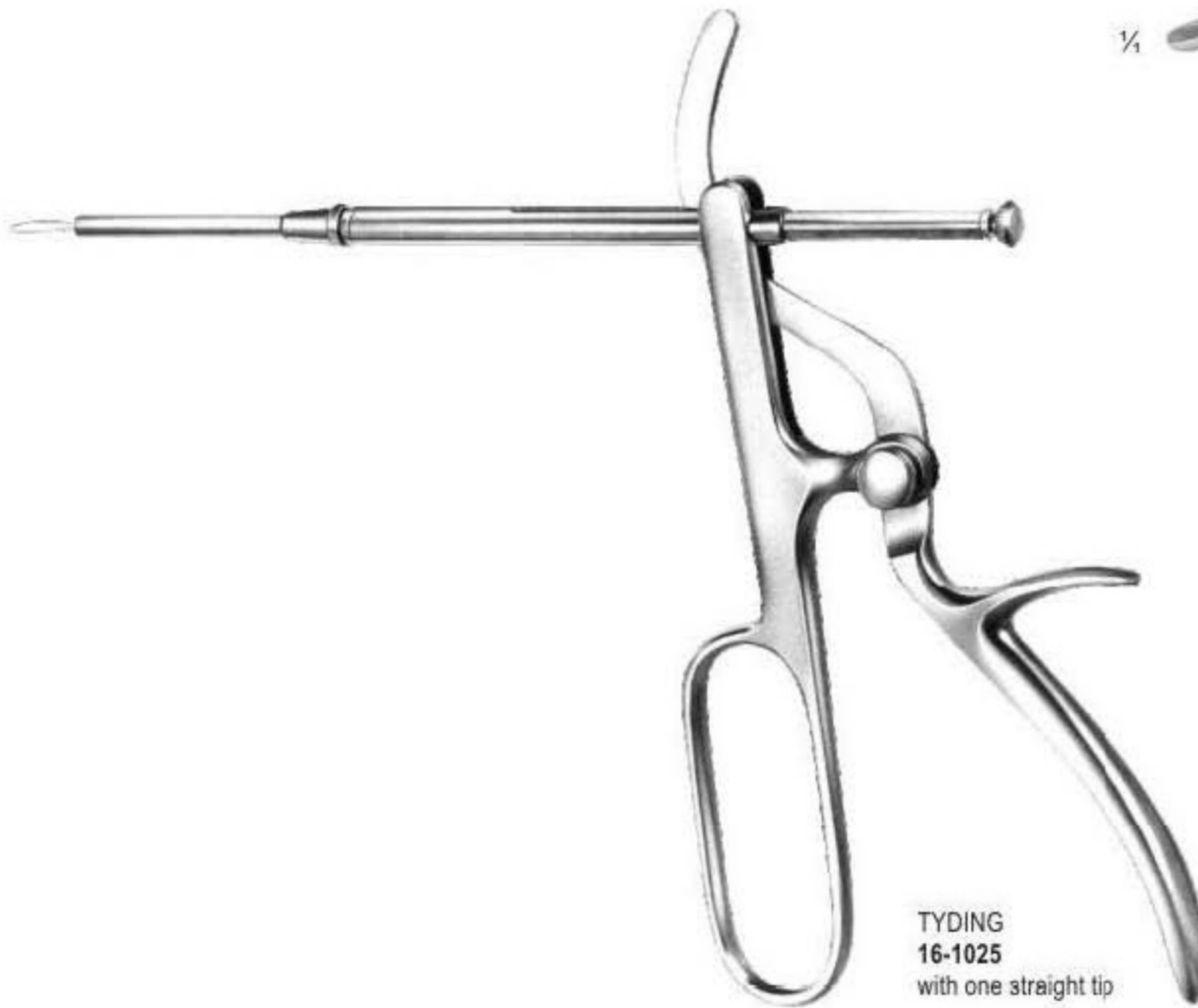

1/2

TYDING
16-1025
with one straight tip

Tonsil Snares

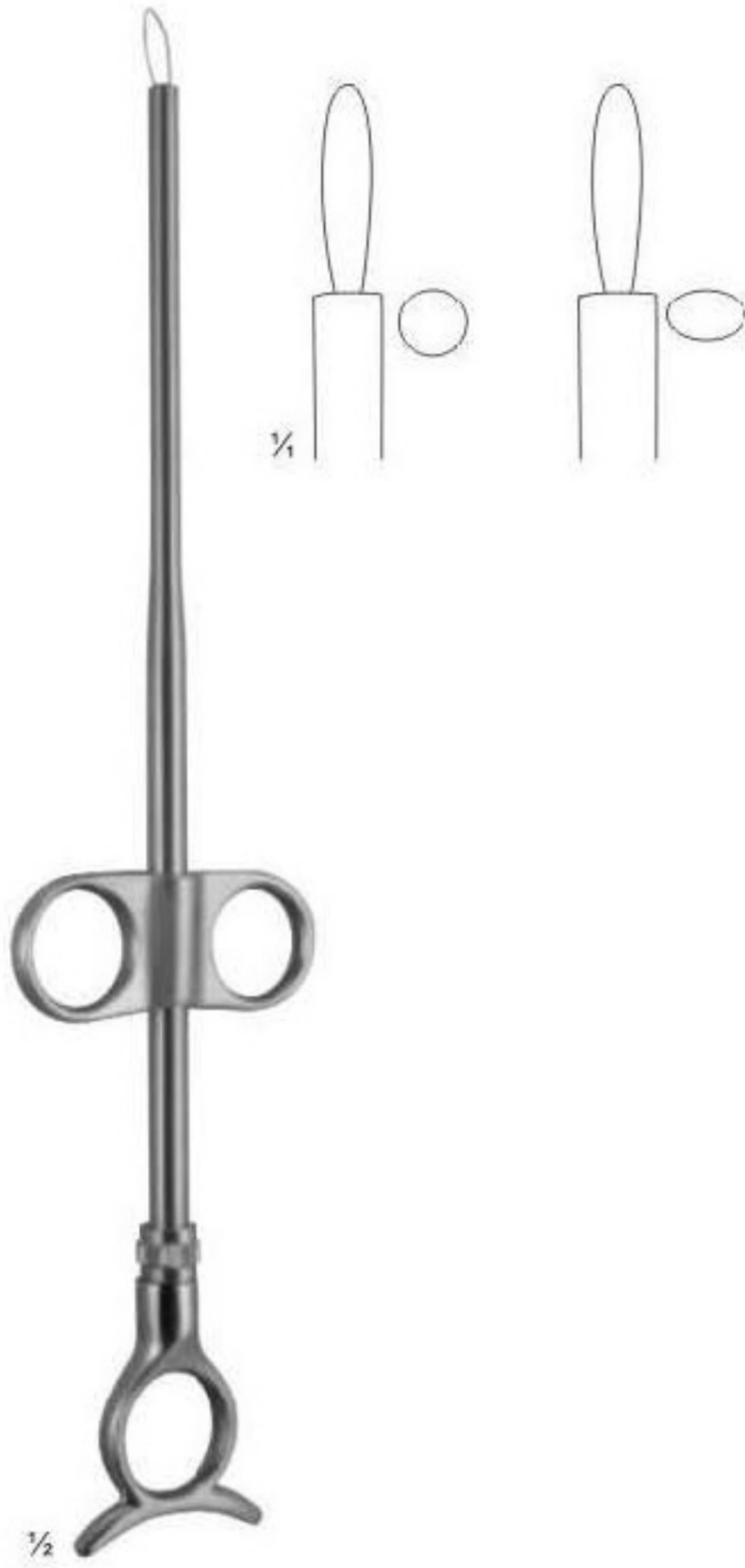

EVES
16-1026
28 cm



EVES
16-1027
28 cm



BRUENINGS
16-1028
28 cm



16-1029 - 16-1030
10 mm - 33 ft.
16-1029 0.3 mm Ø
16-1030 0.4 mm Ø

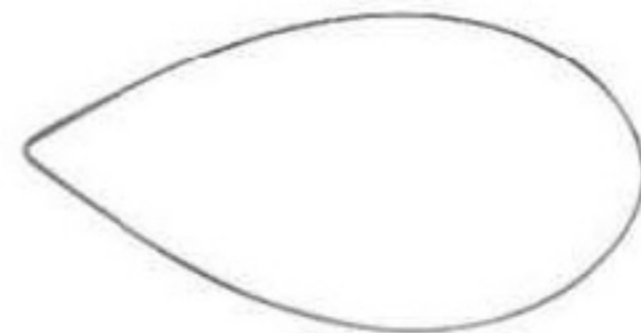

16-1031 - 16-1032
Package of 100 pieces
16-1031 40 mm
16-1032 50 mm

Clip Applying Forceps - Suture Set



COLVER
16-1033
straight curved
19 cm



WHITE
16-1034 - 16-1035
16-1034 18 cm
16-1035 23 cm

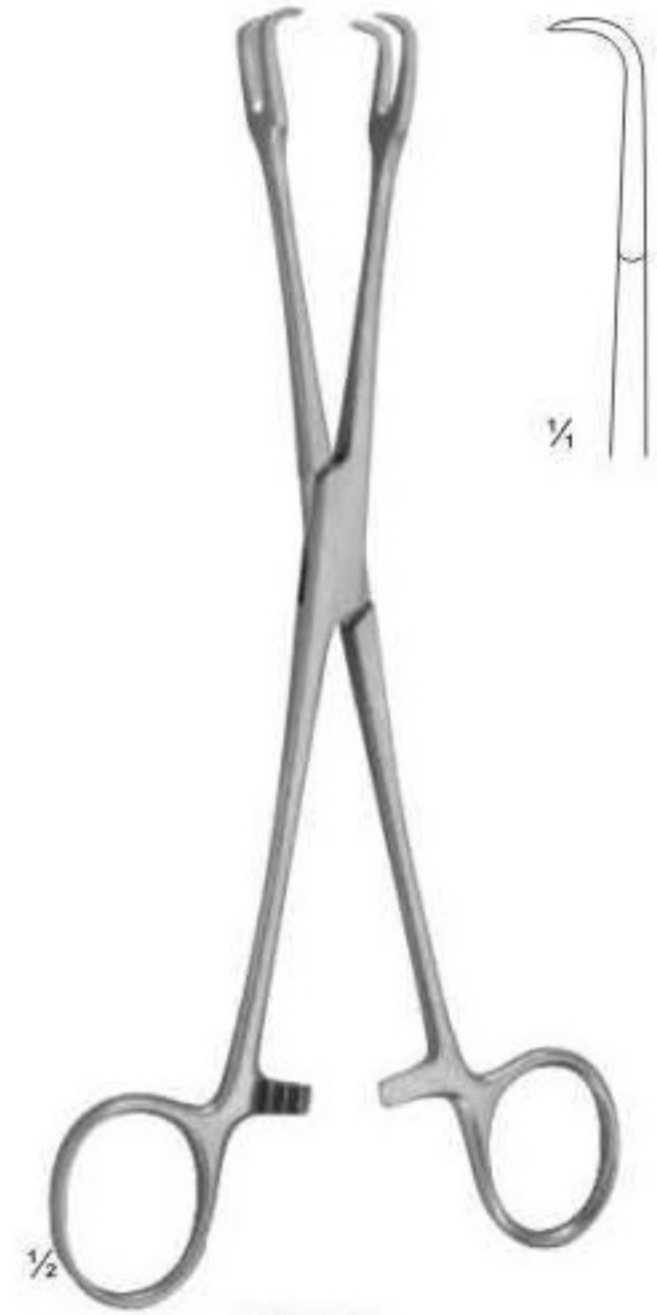

MUSEUX
16-1036
tonsil holding forceps
20 cm

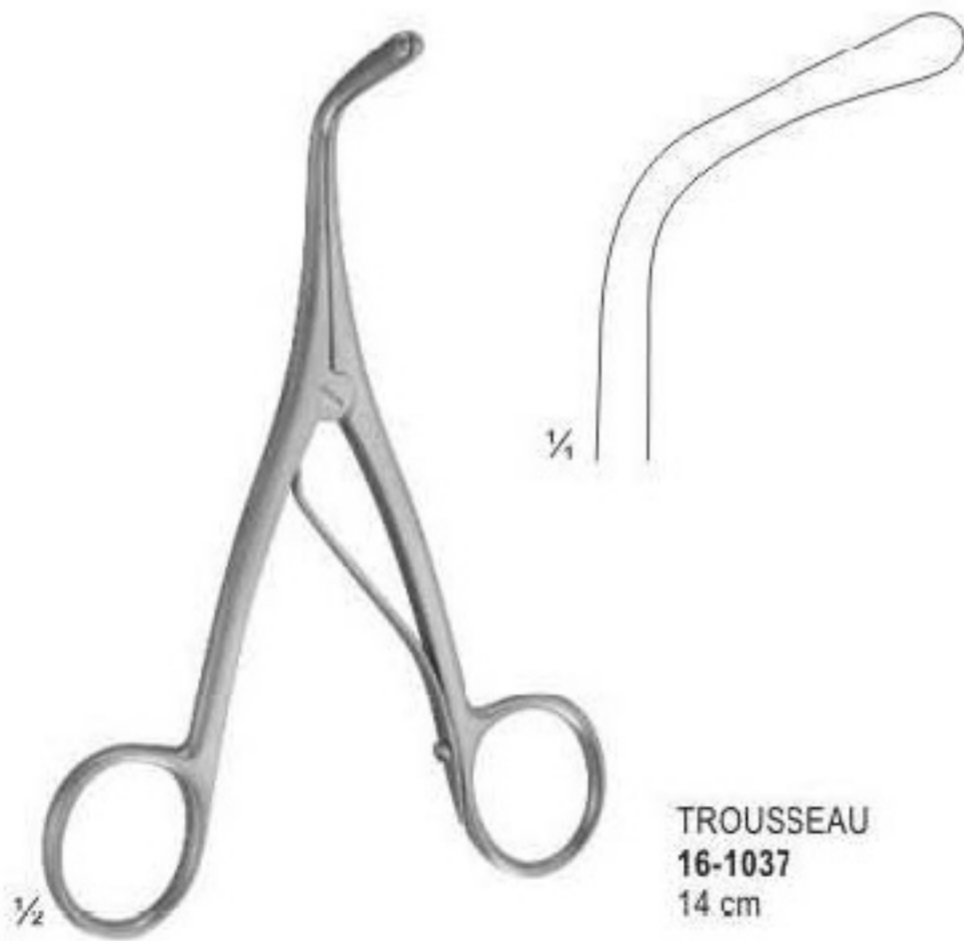

TROUSSEAU
16-1037
14 cm



JACKSON
16-1038
laryngeal forceps
22 cm

Cleft Palate Instruments

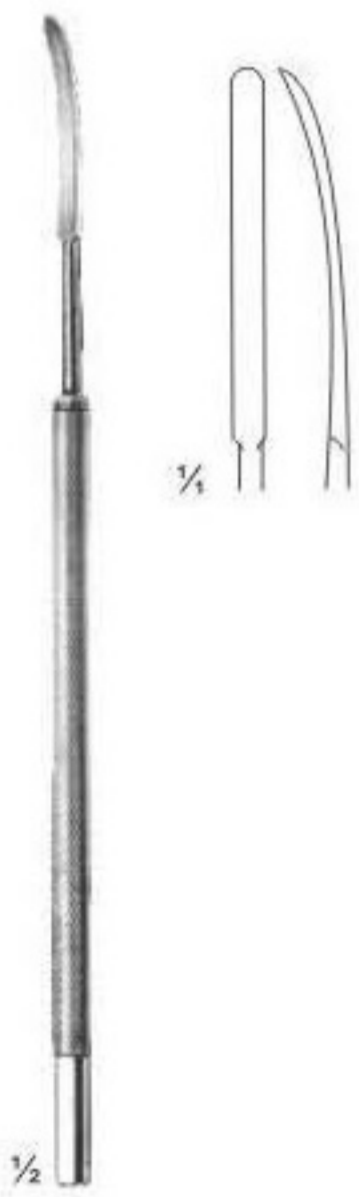

SALYER
16-1039
18 cm
Cleft Palate
Elevator

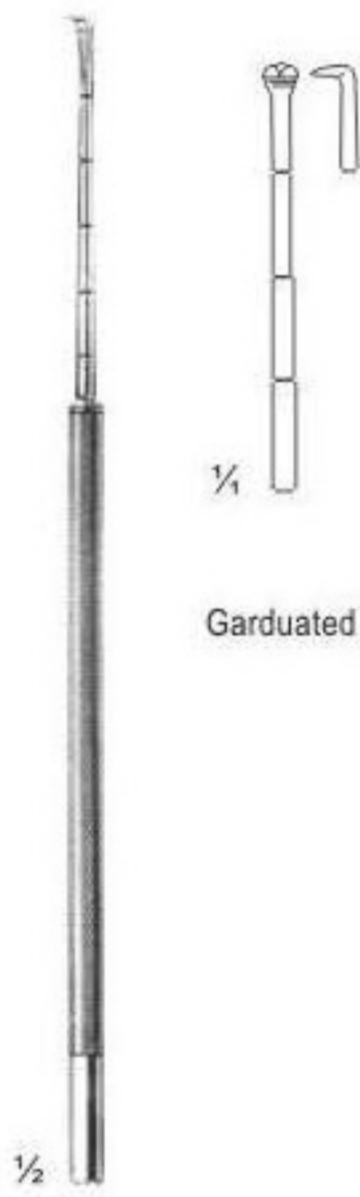

SALYER
16-1040
18 cm
Cleft Palate
Elevator

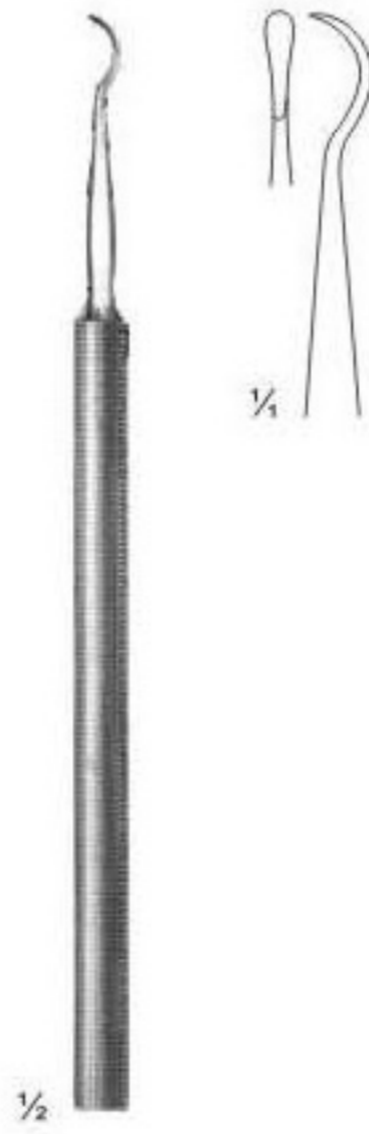

JABOMA
16-1041
17 cm
Cleft Palate
Periosteal Elevator



16-1041
18 cm
left

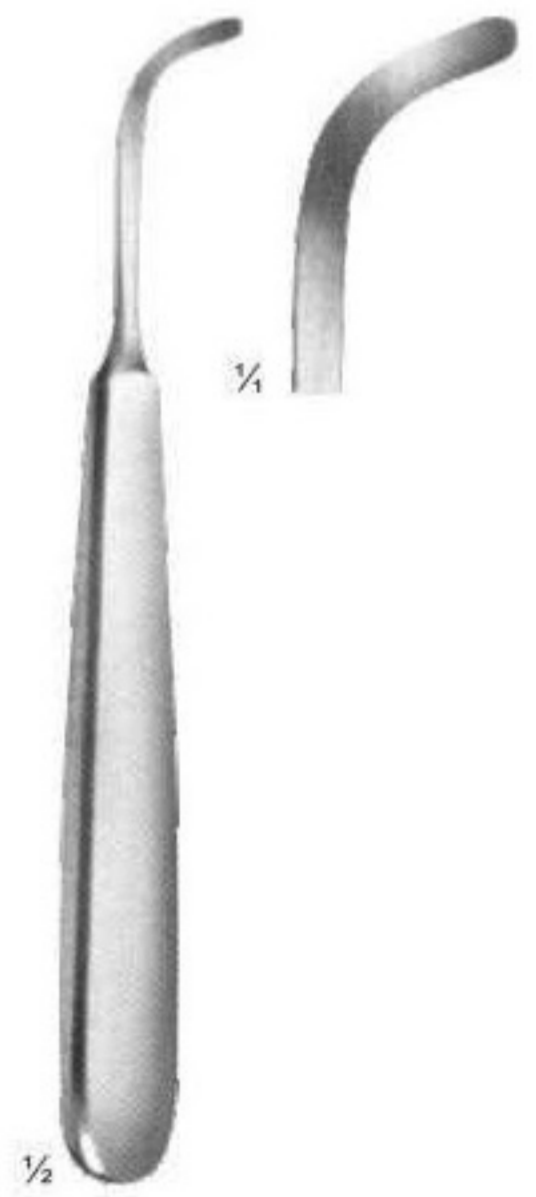

16-1042
18 cm
right

Cleft Palate Instruments

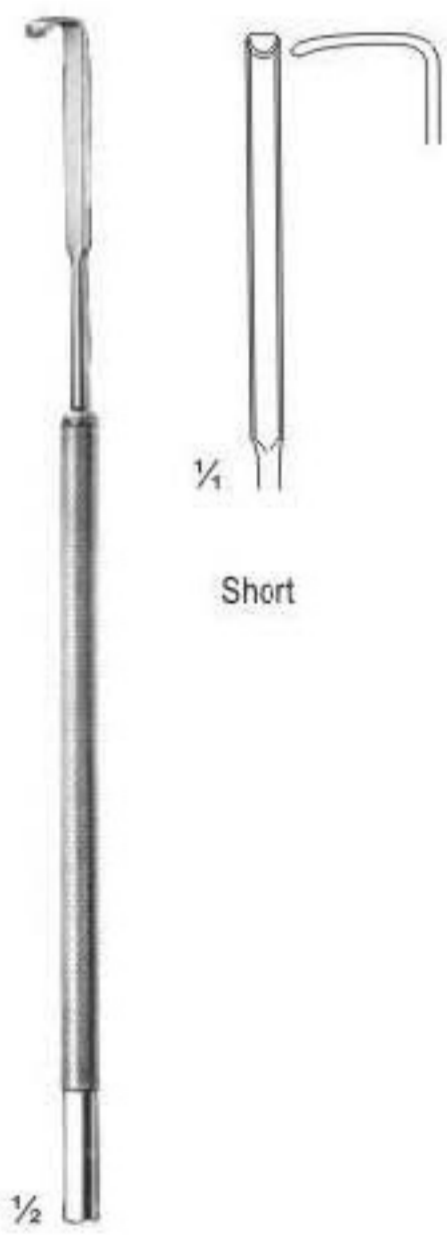

SALYER
16-1043
18.5 cm
Cleft Palate
Hooklets

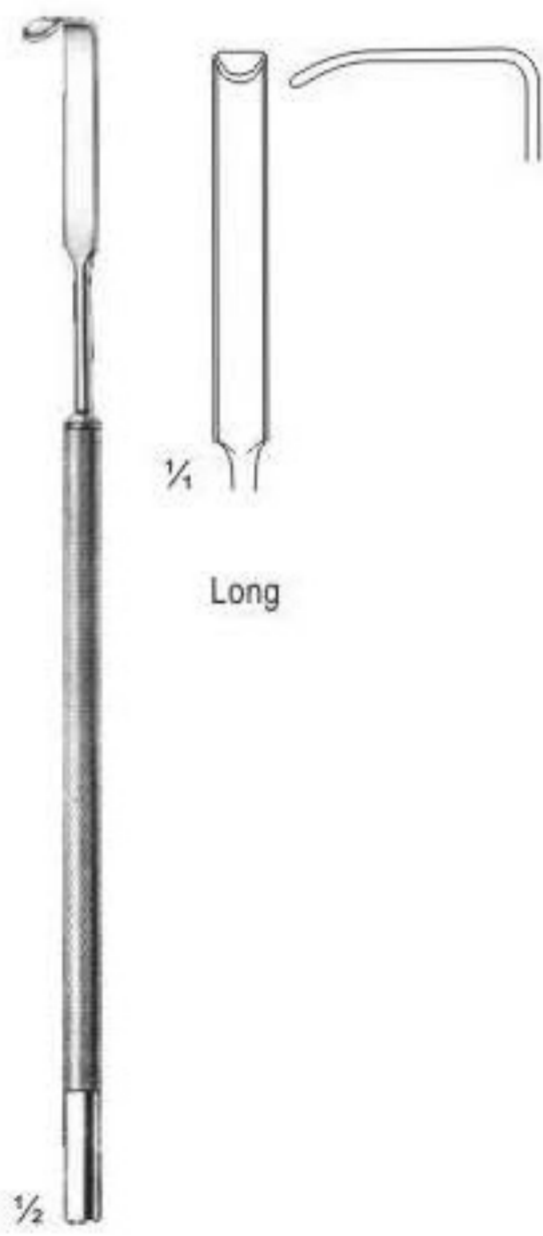

SALYER
16-1044
18.5 cm
Cleft Palate
Hooklet

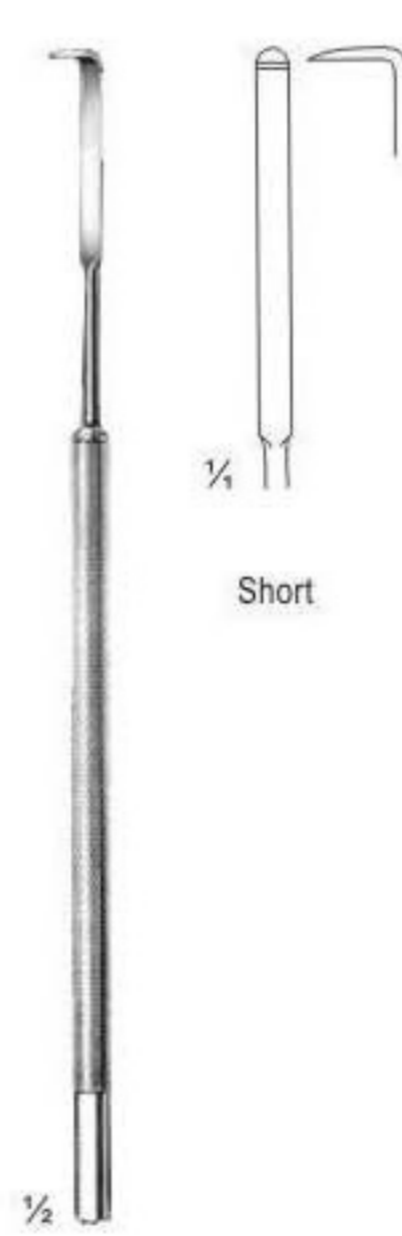

SALYER
16-1045
18 cm
Cleft Palate
Dissector

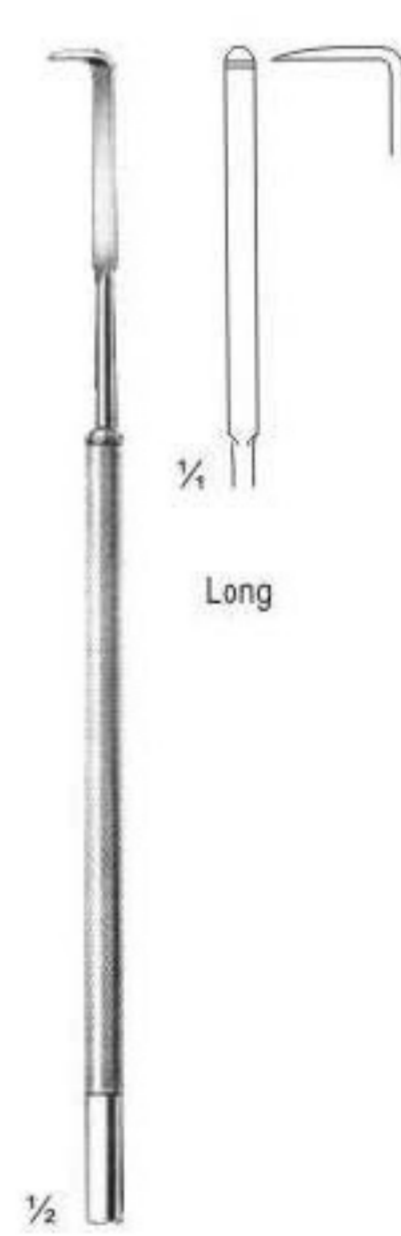

SALYER
16-1046
18 cm
Cleft Palate
Dissector



SALYER
16-1047
18 cm
Cleft Palate
Instruments

Soft Tissue Retractors



OBWEGESER
16-1048 - 16-1050

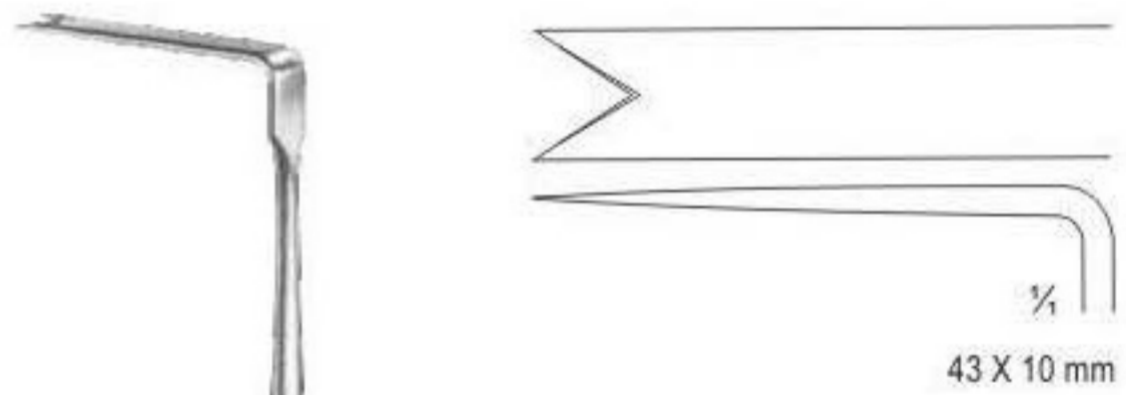
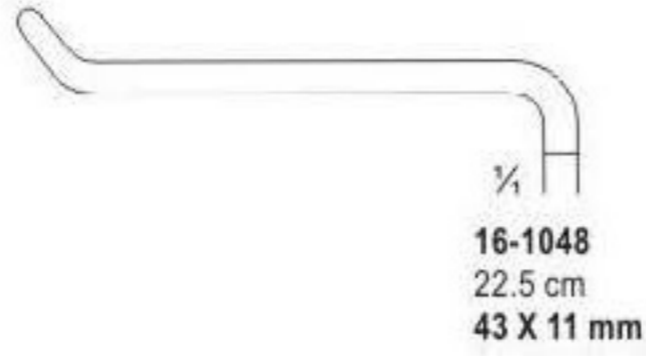

1/2

OBWEGESER
16-1051
22 cm
Nasal Spine Retractor

Ramus, Chin And Channel Retractors



1/2

OBWEGESER
16-1052
22 cm

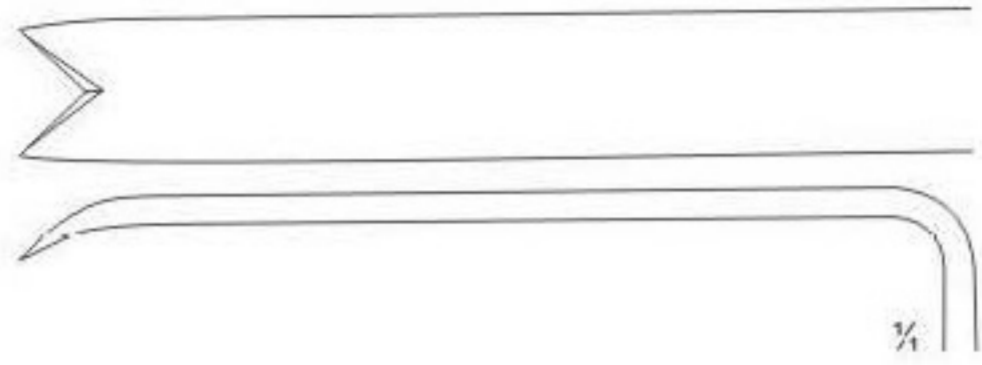

72 X 10 mm



1/2

OBWEGESER
16-1053
16.5 cm



1/2

OBWEGESER
16-1054 - 16-1055

16-1054
16 cm
8 mm

16-1055
16 cm
10 mm

Clip Applying Forceps - Suture Set



ST. CLAIR-THOMSON
16-1056
21 cm



BARNHILL
16-1057
22 cm



BECKMANN
16-1058
Straight Curved
22 cm



BECKMANN
16-1059
Straight Curved
22 cm



BALLENGER
16-1060
straight bayonet
22 cm



X = 3 mm
X = 4 mm
X = 5 mm

Periosteal Elevators



1/2

OBWEGESER
16-1061 - 16-1064
17.5 cm



1/4

16-1061
6 mm



16-1062
7 mm



16-1063
9 mm



16-1064
11 mm



1/4

16-1065
5 mm



16-1066
7 mm



16-1067
9 mm



1/2

OBWEGESER
16-1065 - 16-1067
20 cm

Periosteal Elevators And Orbital Hook



1/2

OBWEGESER
16-1068 - 16-1069
17.5 cm



1/4

16-1068



16-1069



1/2

ROWE
16-1070 - 16-1071
19 cm



1/4

16-1070
left



16-1071
right

Disimpaction Forceps

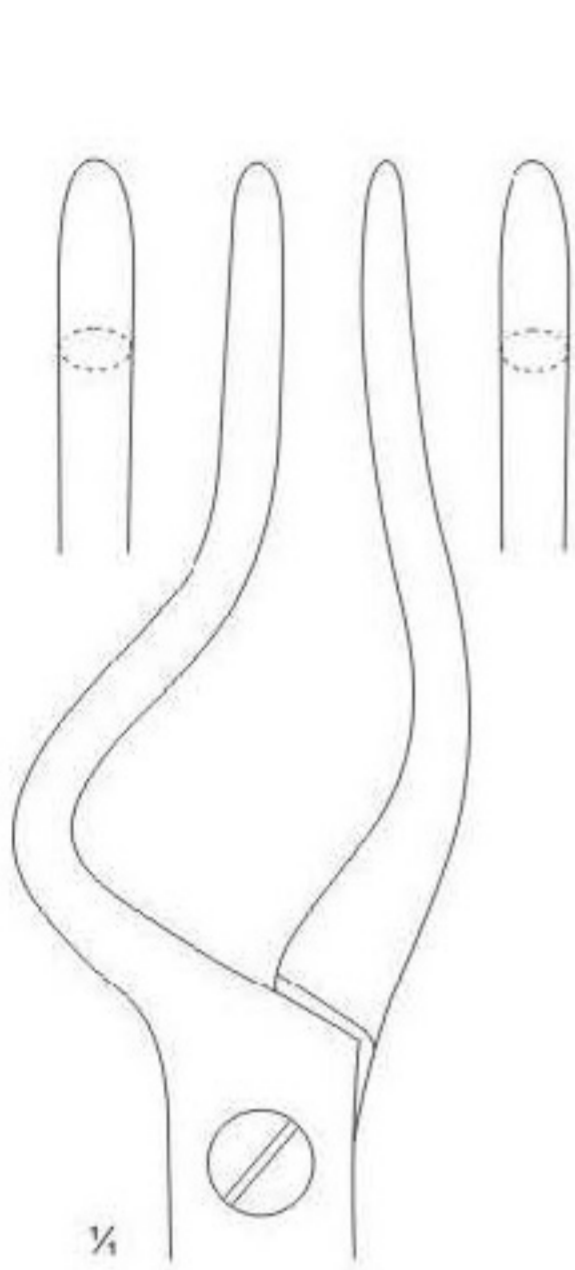

16-1072 - 16-1073
16-1072 L
16-1073 R
21.5 cm

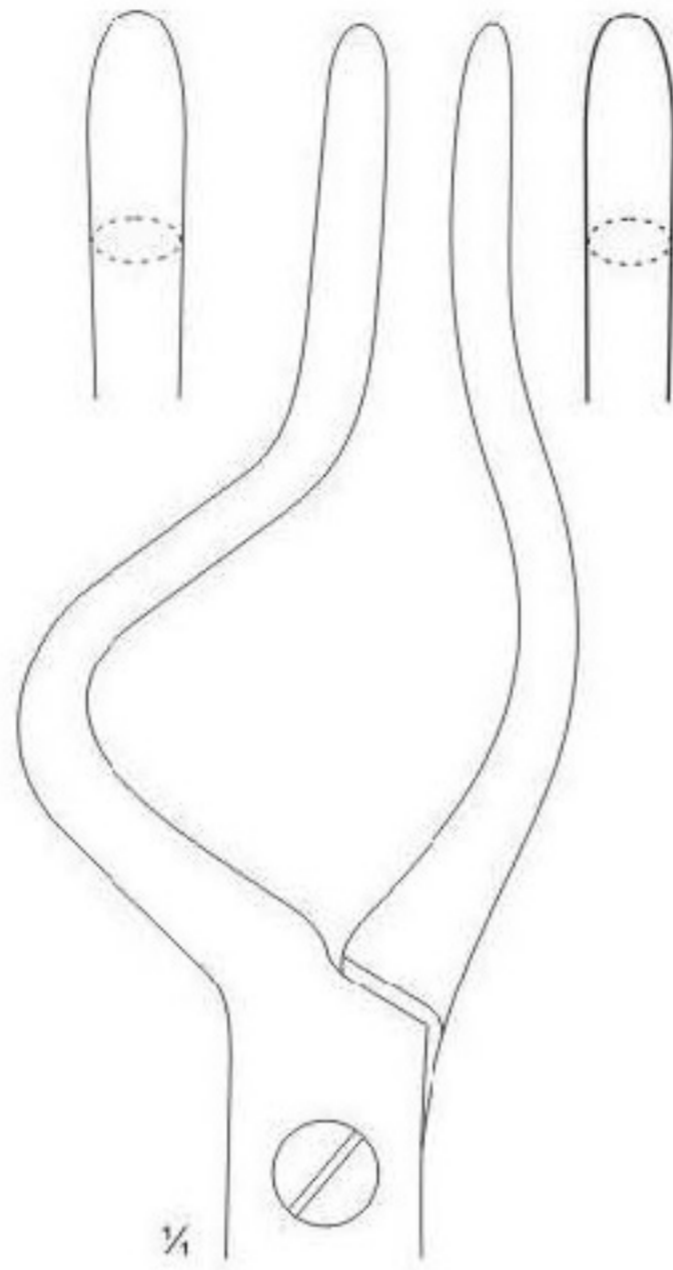

16-1074 - 16-1075
16-1074 L
16-1075 R
24 cm

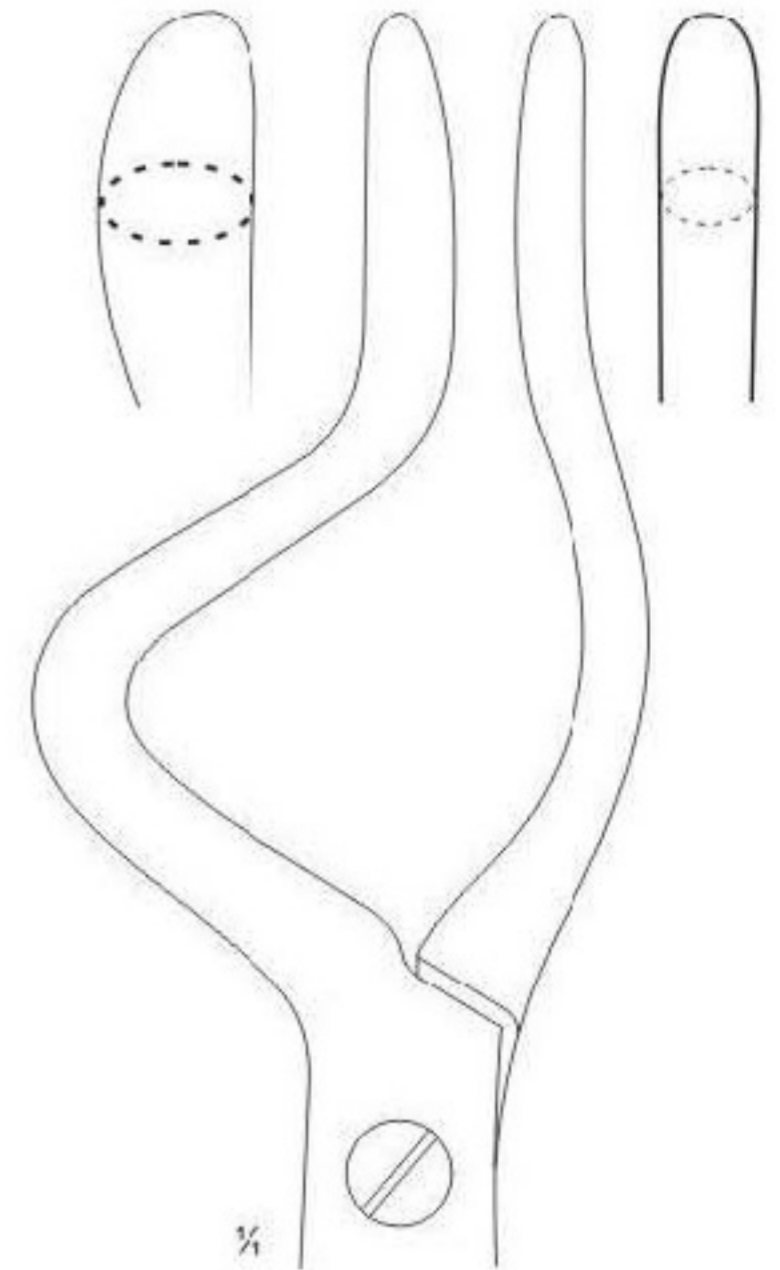

16-1076 - 16-1077
16-1076 L
16-1077 R
24.5 cm



Elevators, Osteotomes, Wire Pushers



OBWEGESER
16-1078
20.5 cm



OBWEGESER
16-1079
20.5 cm



OBWEGESER
16-1080
15 cm



16-1081
17 cm



ROWE
16-1082
15 cm

Mouth Gags



DAVIS-BOYLE
16-1083 - 16-1085
complete, consisting of frame
and 5 tongue depressors no. 1-5

16-1083
Frame for Mouth Gag

16-1084
14.5 cm
Frame for Mouth Gag with joint

16-1085
14.5 cm
Silicone inlay



16-1090
with fixed suction tube

1/2

Fig. 1
16-1086 - 16-1090
110 X 28 mm



Fig. 2
16-1086
95 X 27 mm



Fig. 3
16-1087
80 X 27 mm



Fig. 4
16-1088
65 X 26 mm



Fig. 5
16-1089
without suction tube
30 X 20 mm

Mouth Gags



MOLT
16-1091
for children
11 cm



MOLT
16-1092
for adults
14 cm



DENHART
16-1093
12 cm



FERGUSON - ACKLAND
16-1094
14.5 cm



ROSER - KONIG
16-1095 - 16-1096
16-1095 16 cm
16-1096 19 cm

Mouth Gags



1/2

MAUNDER
16-1097
9.5 cm
Wood



1/2

HEISTER
16-1098
13 cm



1/2

OBWEGESER
16-1099
11 cm
Spreading
47 mm

Mouth Gags



NEUKAM
16-1100 - 16-1104
complete, with frame
and 3 tongue depressors

NEUKAM
16-1100
Frame for Mouth Gag, only



16-1101
Tongue Depressor
fenestrated blade for suction



Fig. 1
16-1102

Fig. 2
16-1103

Fig. 3
16-1104



KILNER-DOUGHTY
16-1105 - 16-1110
complete, with frame, 3 tongue depressors,
2 toothplates and 1 palate plate



16-1105
Palate plate

KILNER-DOUGHTY
16-1107
Tongue Depressor
fenestrated blade for suction



Fig. 1
16-1108
68 X 30 mm

Fig. 2
16-1109
77 X 34 mm

Fig. 3
16-1110
82 X 39 mm

KILNER-DOUGHTY
16-1106
14.5 cm
Frame for Mouth Gag

Mouth Gags



MCLVOR
16-1111 - 16-1115
complete, with 3 tongue depressors

MCLVOR
16-1111
Frame for Mouth Gag



MCLVOR
16-1112
Tongue Depressors

Fig. 1
16-1113
100 X 25 mm

Fig. 2
16-1114
85 X 25 mm

Fig. 3
16-1115
75 X 25 mm



DINGMANN
16-1116 - 16-1119
complete, with frame, 3 tongue depressors,
and 2 adjustable lateral blades

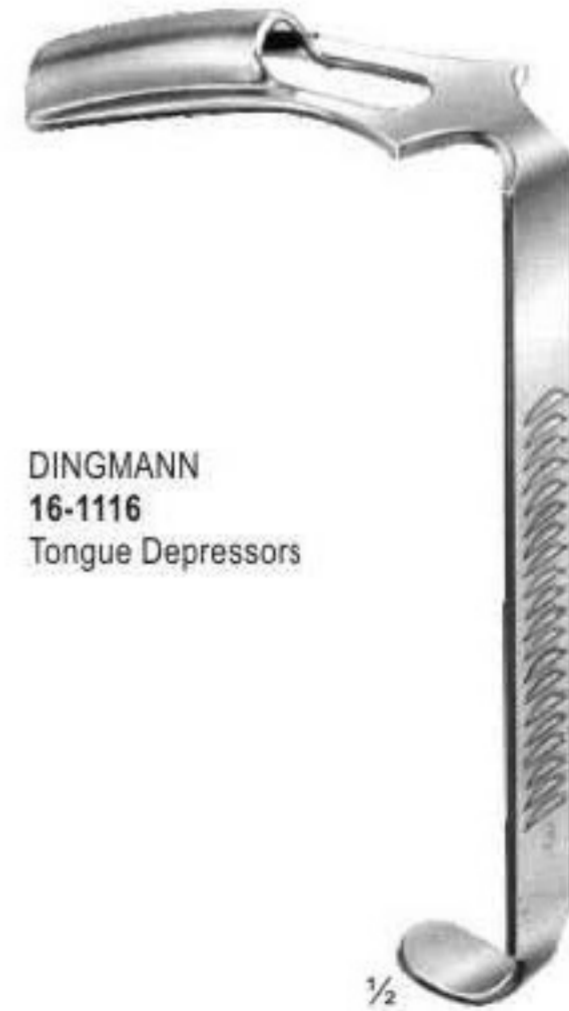

DINGMANN
16-1116
Tongue Depressors

Fig. 1
16-1117
62 X 26 mm

Fig. 2
16-1118
65 X 30 mm

Fig. 3
16-1119
78 X 32 mm

Mouth Gags, Lip And Cheek Retractors



JENNINGS
16-1120 - 16-1123
16-1120 10.5 cm
16-1121 12.5 cm
16-1122 14.5 cm
16-1123 16.5 cm



ORINGER
16-1124 - 16-1126
 9.5 cm
 self retaining, for children

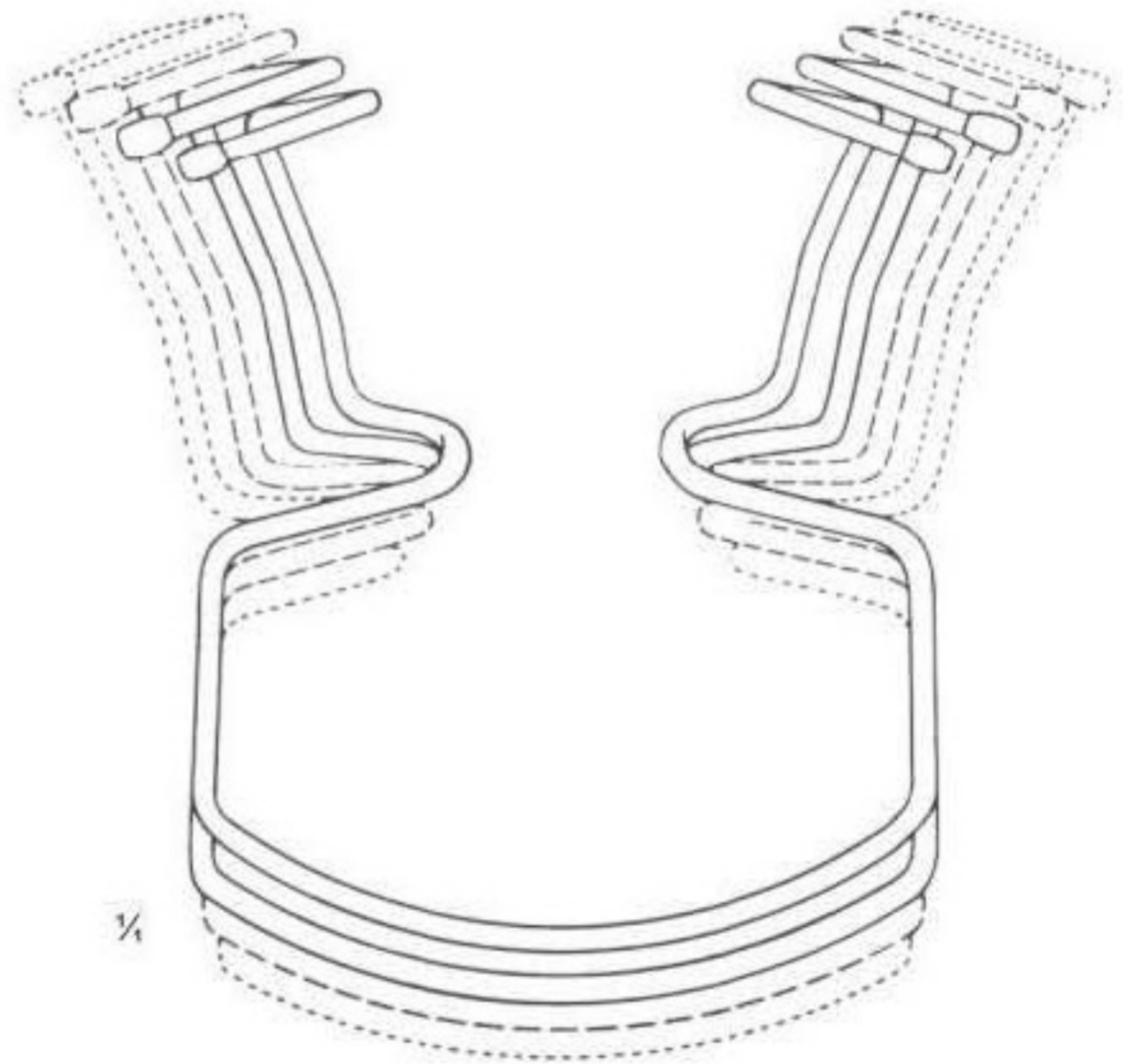

Fig. 1
16-1124
 10 cm

Fig. 2
16-1125
 10.5 cm

Fig. 3
16-1126
 11 cm

Cleft Palate Needles, Tonsil Knife



Exchangeable Tips

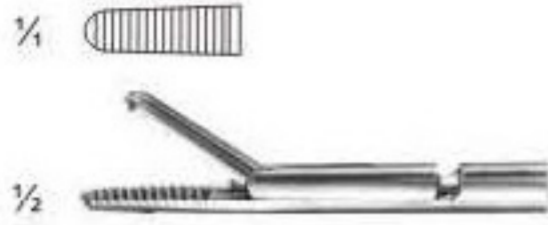

FRAENKEL
16-1132
for interchangeable tubes

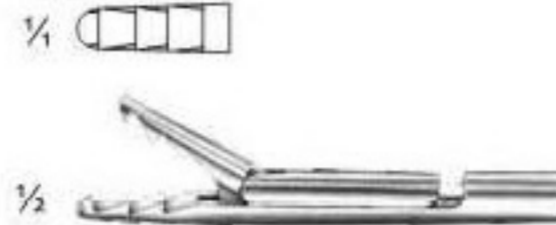

SEIFFERT
16-1133
for interchangeable tubes

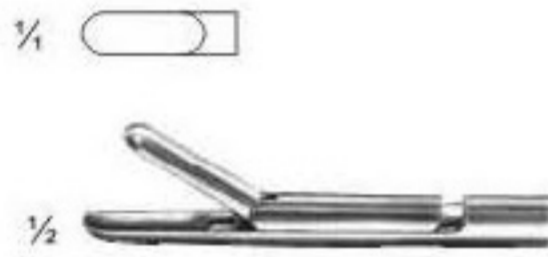

FRAENKEL
16-1134
for interchangeable tubes



SCHEINMANN
16-1135
for interchangeable tubes



SCHEINMANN
16-1136
for interchangeable tubes



BRÜNINGS
16-1137 - 16-1138
for interchangeable tubes

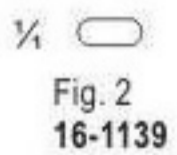
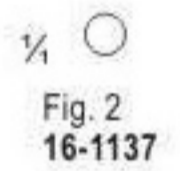

BRÜNINGS
16-1139 - 16-1140
for interchangeable tubes



LANGE
16-1141
for interchangeable tubes

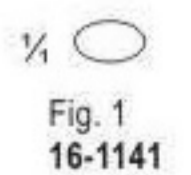

Blood Lancets & Laryngeal Mirrors

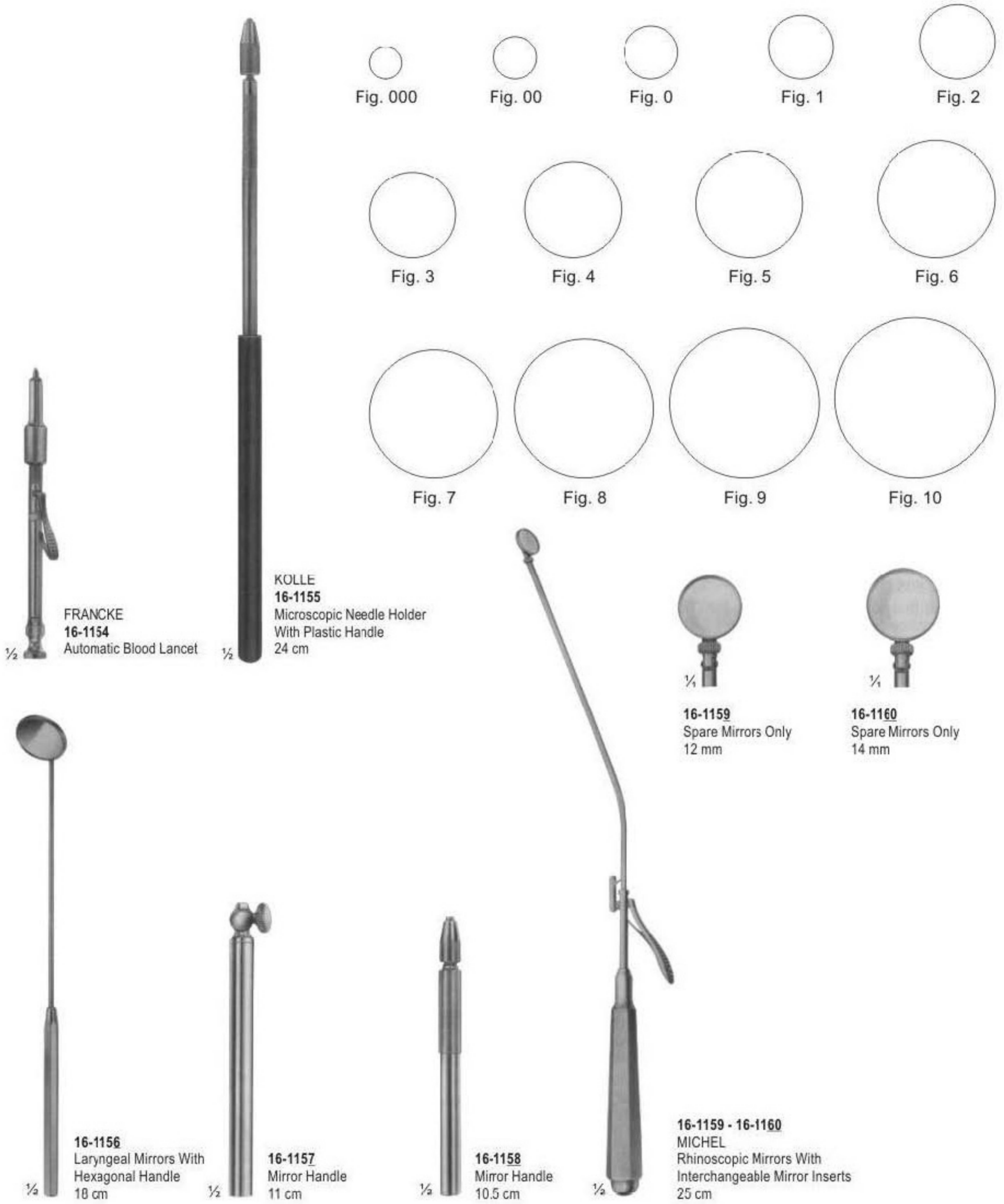

1/2 **FRANCKE**
16-1154
Automatic Blood Lancet

1/2 **KOLLE**
16-1155
Microscopic Needle Holder
With Plastic Handle
24 cm

Fig. 000

Fig. 00

Fig. 0

Fig. 1

Fig. 2

Fig. 3

Fig. 4

Fig. 5

Fig. 6

Fig. 7

Fig. 8

Fig. 9

Fig. 10

1/4 **16-1159**
Spare Mirrors Only
12 mm

1/4 **16-1160**
Spare Mirrors Only
14 mm

1/4 **16-1156**
Laryngeal Mirrors With
Hexagonal Handle
18 cm

1/2 **16-1157**
Mirror Handle
11 cm

1/4 **16-1158**
Mirror Handle
10.5 cm

1/4 **16-1159 - 16-1160**
MICHEL
Rhinoscopic Mirrors With
Interchangeable Mirror Inserts
25 cm

Blood Lancets & Laryngeal Mirrors

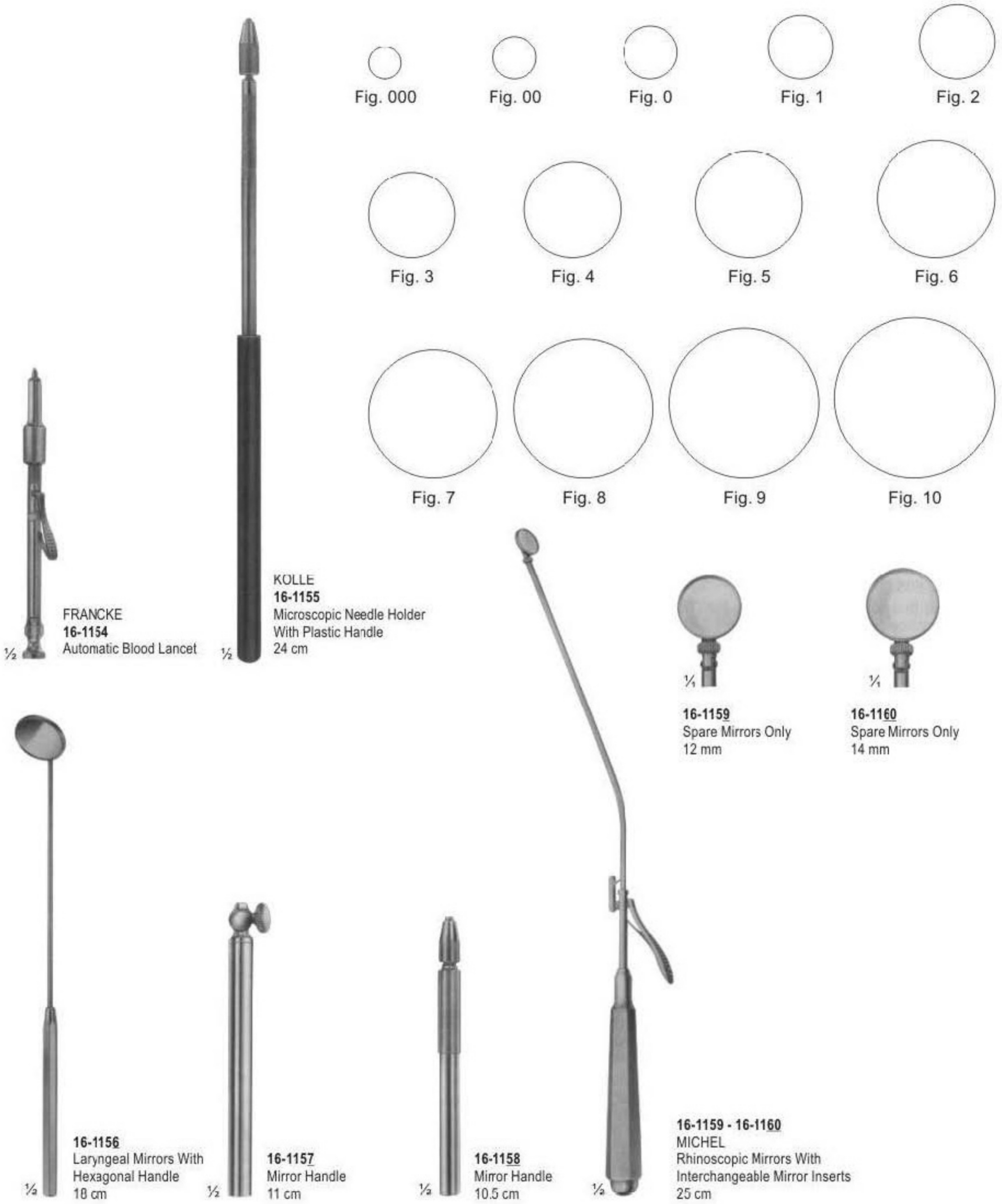

1/2 **FRANCKE**
16-1154
Automatic Blood Lancet

1/2 **KOLLE**
16-1155
Microscopic Needle Holder
With Plastic Handle
24 cm

Fig. 000 Fig. 00 Fig. 0 Fig. 1 Fig. 2
Fig. 3 Fig. 4 Fig. 5 Fig. 6
Fig. 7 Fig. 8 Fig. 9 Fig. 10

1/4 **16-1159**
Spare Mirrors Only
12 mm

1/4 **16-1160**
Spare Mirrors Only
14 mm

1/4 **16-1156**
Laryngeal Mirrors With
Hexagonal Handle
18 cm

1/2 **16-1157**
Mirror Handle
11 cm

1/4 **16-1158**
Mirror Handle
10.5 cm

1/4 **16-1159 - 16-1160**
MICHEL
Rhinoscopic Mirrors With
Interchangeable Mirror Inserts
25 cm

Tongue Depressors



1/2

HARTMANN
16-1161
15 cm



1/4

72 X 24 mm



1/2

TOBOLD
16-1162
15 cm



1/4

83 X 25 mm



1/2

TOBOLD
16-1163
16 cm

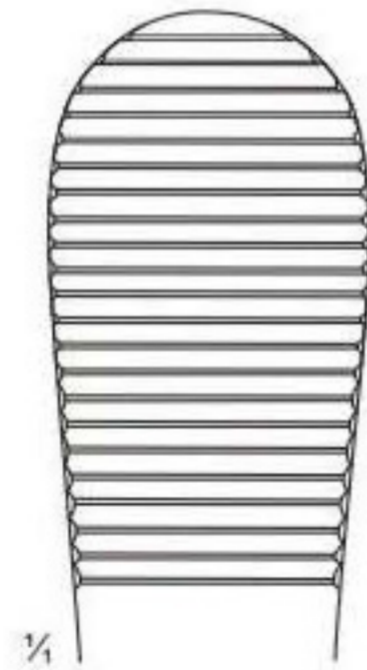

1/4



1/2

WIEDER
16-1164 - 16-1165

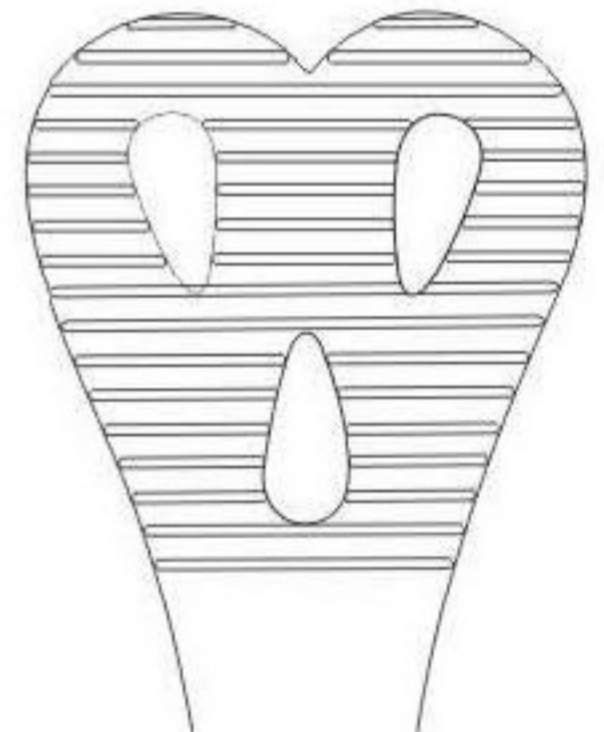

16-1164
15 cm
43 mm

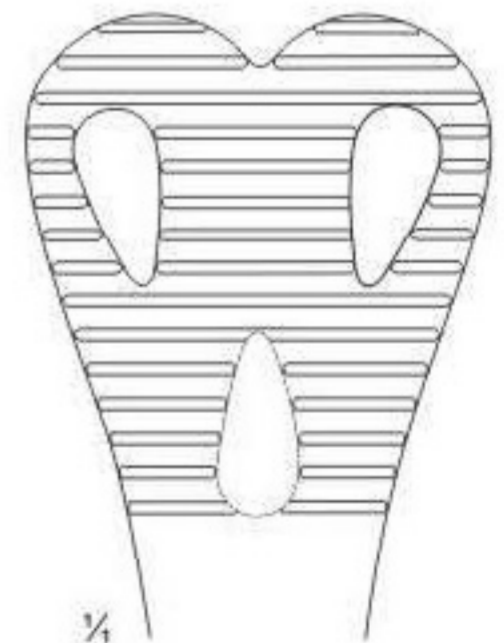

1/4

16-1165
14 cm
36 mm

Wound-and Tracheal Hooks And Dilators

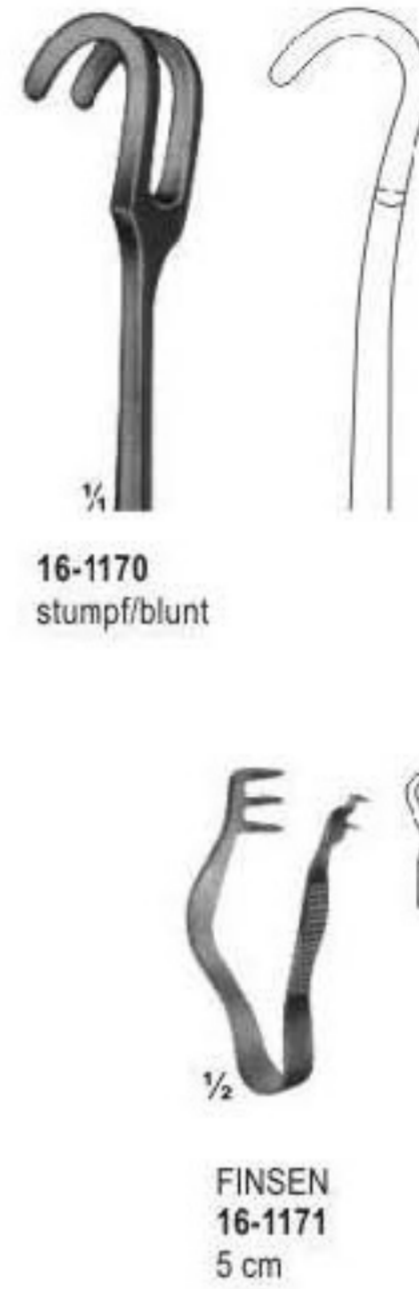
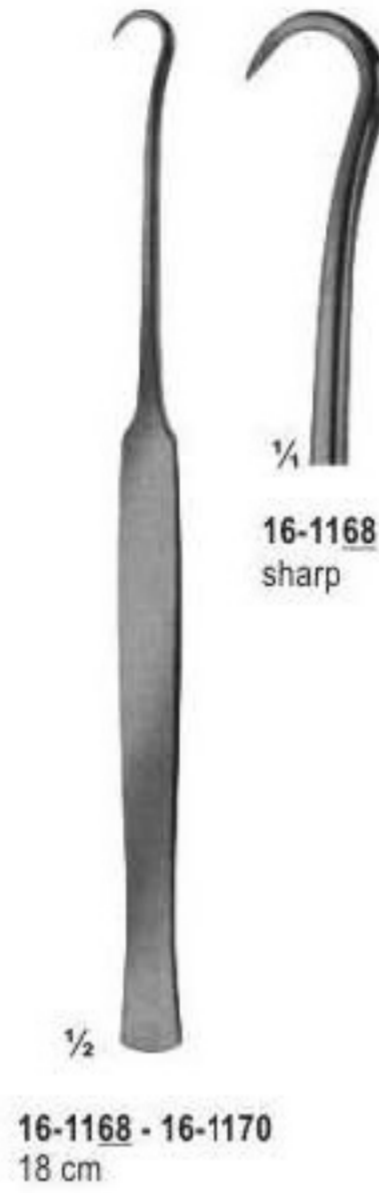

Tracheal Tubes With Inner Tubes



UECKERMANN-DENKER
16-1177
Cryothyrotomy trocar
with silver cannula
13 cm

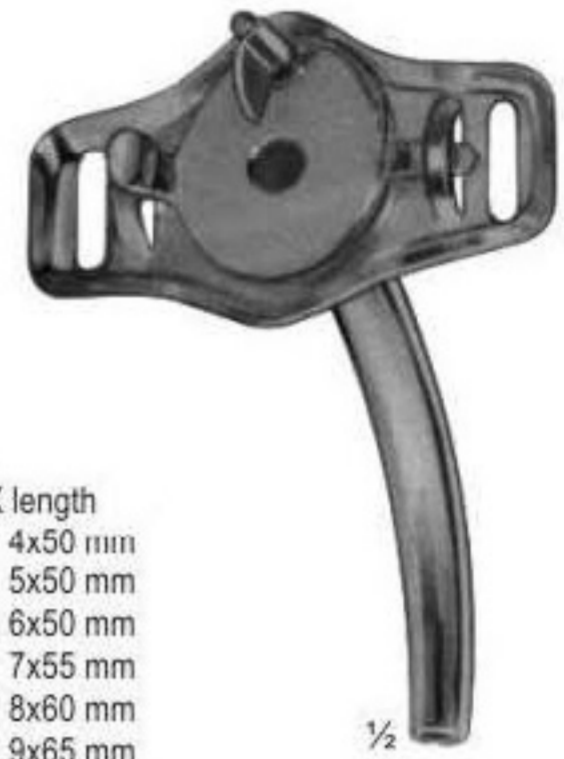

Diam. X length
16-1178 Fig. 0= 4x50 mm
16-1179 Fig. 1= 5x50 mm
16-1180 Fig. 2= 6x50 mm
16-1181 Fig. 3= 7x55 mm
16-1182 Fig. 4= 8x60 mm
16-1183 Fig. 5= 9x65 mm
16-1184 Fig. 6= 10x70 mm
16-1185 Fig. 7= 11x80 mm
16-1186 Fig. 8= 12x85 mm
16-1187 Fig. 9= 13x90 mm
16-1188 Fig. 10= 14x90 mm

LUER
16-1178 - 16-1188
German silver



JACKSON
16-1189 - 16-1198
German Silver

Diam. X length
16-1189 Fig. 0= 4x50 mm
16-1190 Fig. 1= 5x58 mm
16-1191 Fig. 2= 6x58 mm
16-1192 Fig. 3= 7x70 mm
16-1193 Fig. 4= 8x78 mm
16-1194 Fig. 5= 9x84 mm
16-1195 Fig. 6= 10x84 mm
16-1196 Fig. 7= 11x86 mm
16-1197 Fig. 8= 12x88 mm
16-1198 Fig. 9= 13x90 mm



Diam. X length
16-1199 Fig. 1= 5x48 mm
16-1200 Fig. 2= 6x58 mm
16-1201 Fig. 3= 7x70 mm
16-1202 Fig. 4= 8x78 mm
16-1203 Fig. 5= 9x84 mm
16-1204 Fig. 6= 10x84 mm
16-1205 Fig. 7= 11x86 mm
16-1206 Fig. 8= 12x88 mm
16-1207 Fig. 9= 13x90 mm
16-1208 Fig. 10= 14x90 mm

JACKSON
16-1199 - 16-1208
German Silver

Page 405-497



- Tendon Holding Forceps, Tendon Tunneling Forceps & Tendon Interfacing Forceps
- Meniscus & Cartilage Seizing
- Reposition & Bone Holding Forceps
- Bone Clamps
- Wire Holding Forceps, Flat-nosed Pliers, Pliers For Bending & Cutting Wires
- Synovectomy-rongeurs
- Bone Rongeurs
- Bone Cutting Forceps
- Bone Holding Forceps
- Lateral Cutting Action, Lateral & Front Cutting Action
- Wire Cutting Pliers
- Mallets
- Bone Curetters, Double-ended
- Raspatories With HARTPRESS - Handle
- Tampers - Osteotomes, Chisels & Gouges
- Rib Raspatories
- Elevators & Bone Levers
- Alveotomy File
- Periosteal Elevators
- Bone File & Rasps

- Meniscus Knives
- Tendon Strippers
- Wire Extension
- Traction Bows, Distractor
- Steinmann Pins
- Drilling Chucks
- Finger Nail Instruments
- Amputation Retractors
- Wire Cutters & Wire Scissors
- Wire Tightening Pliers
- Tendon Seizing Forceps



Tendon Holding Forceps, Tendon Interlacing Forceps



17-1001
11.5 cm



17-1002
15 cm



KLEINERT-KUTZ
17-1003
21 cm
Shaft Length
14 cm



17-1004
15 cm

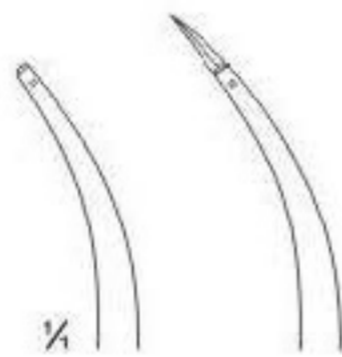

17-1005
14.5 cm
Bore Holding
Forceps

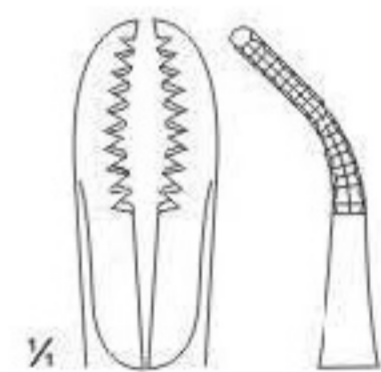

Tendon Holding Forceps, Tendon Tunneling Forceps

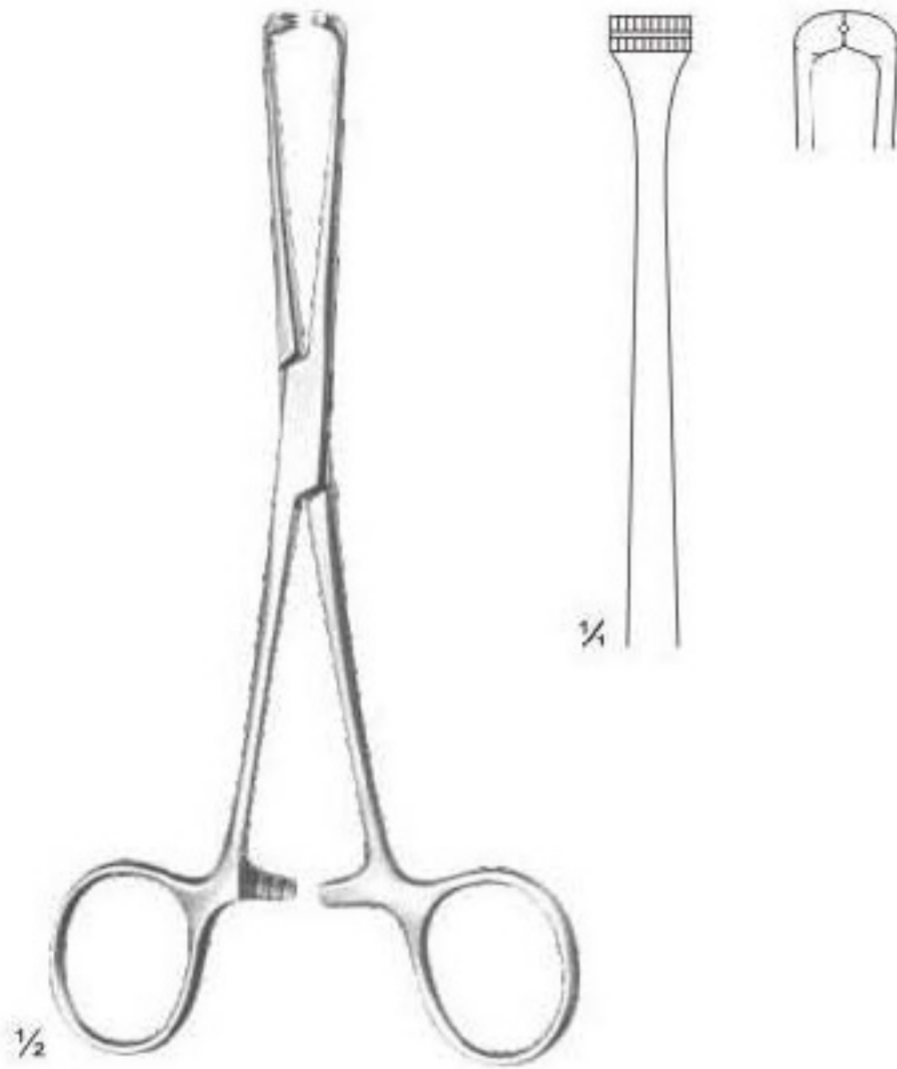

STEINMANN
17-1006
16 cm

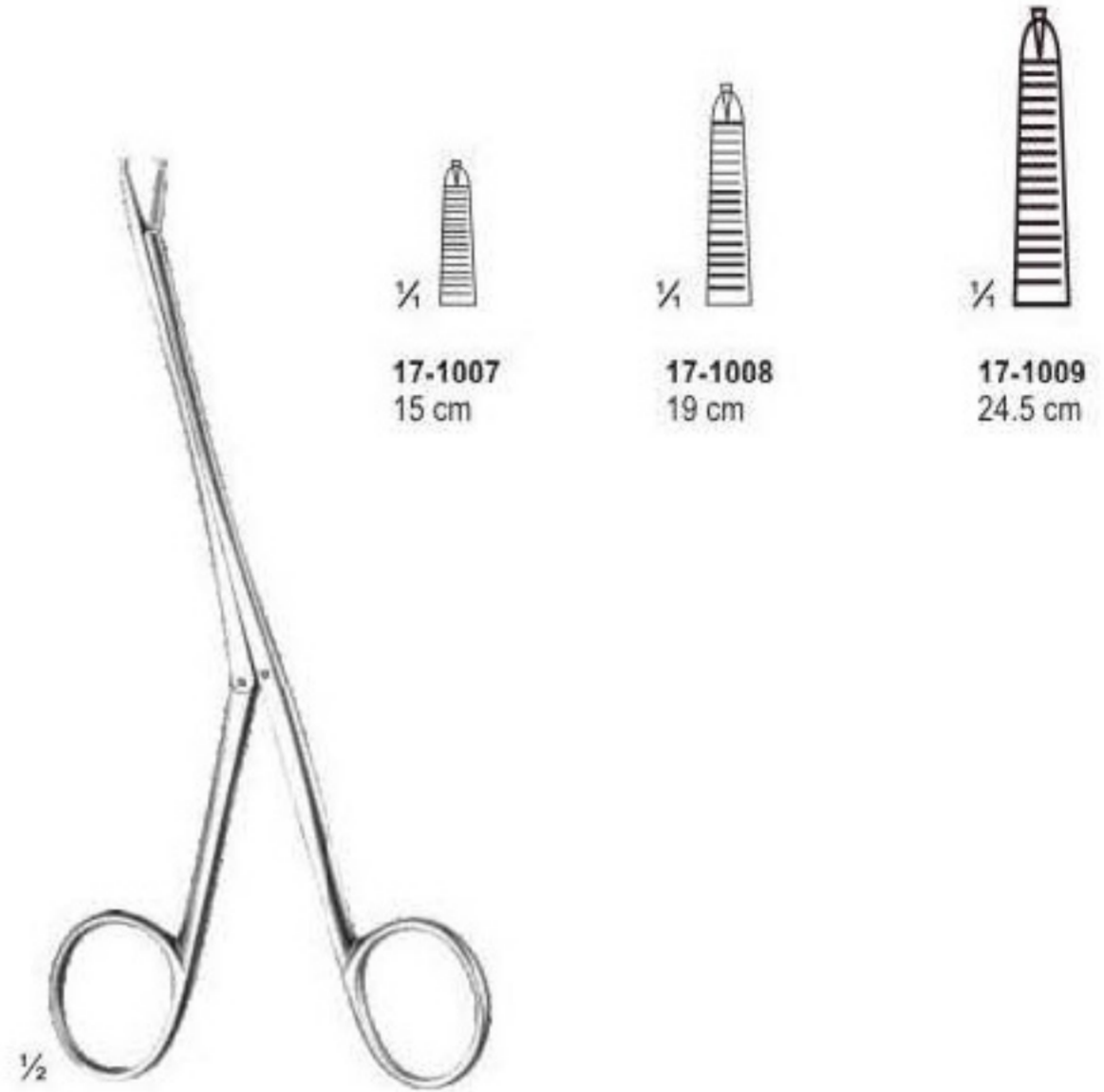

BRAND
17-1007 - 17-1009

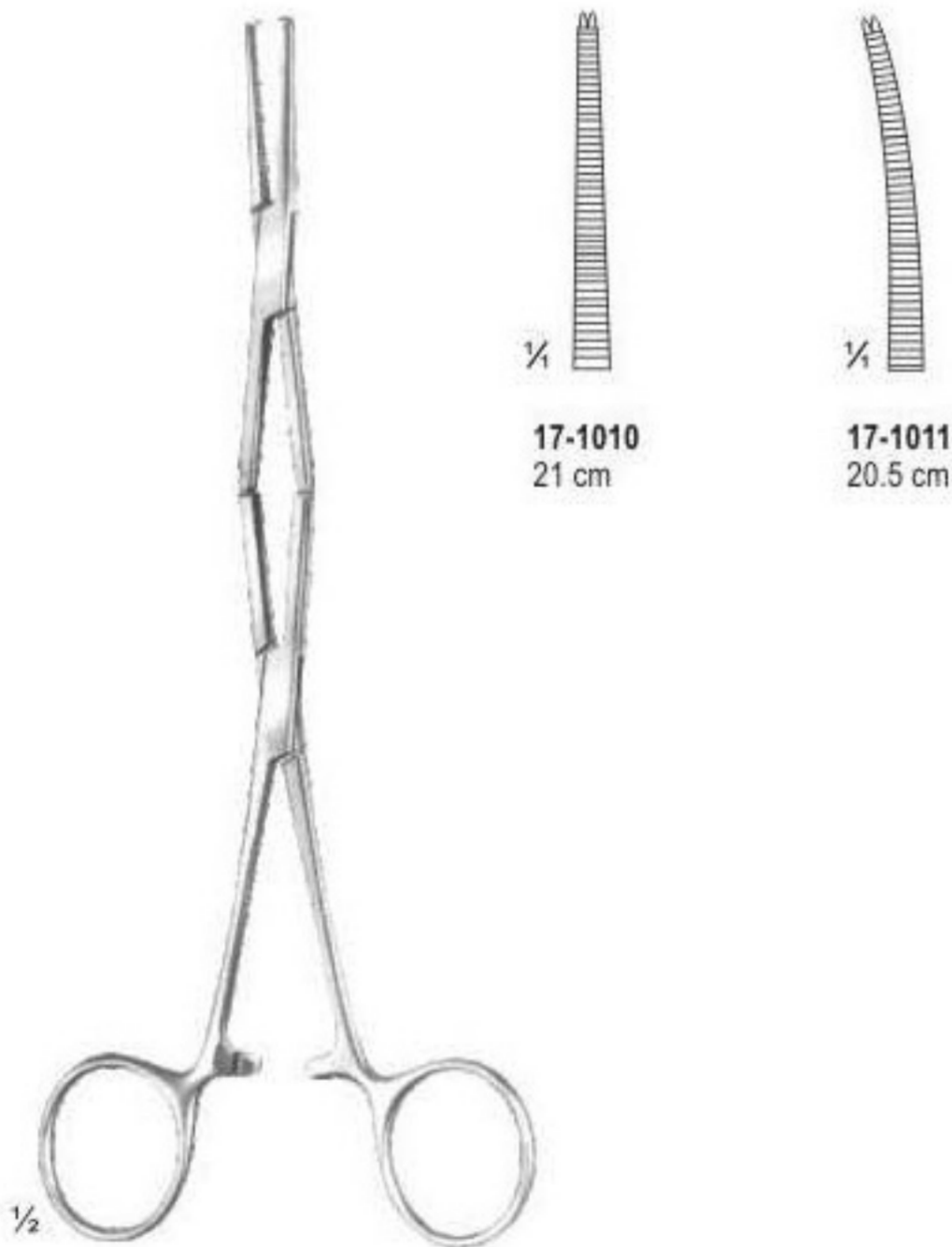

17-1010 - 17-1011



CARROLL
17-1012
11.5 cm

Cartilage seizing, Repositioning, Bone Holding Forceps



Repositioning forceps,
for small fragments
17-1013
13.5 cm



HAASE
Repositioning forceps,
for mandibular
fractures
17-1014
16.5 cm



REILL
Repositioning forceps,
17-1015
17 cm

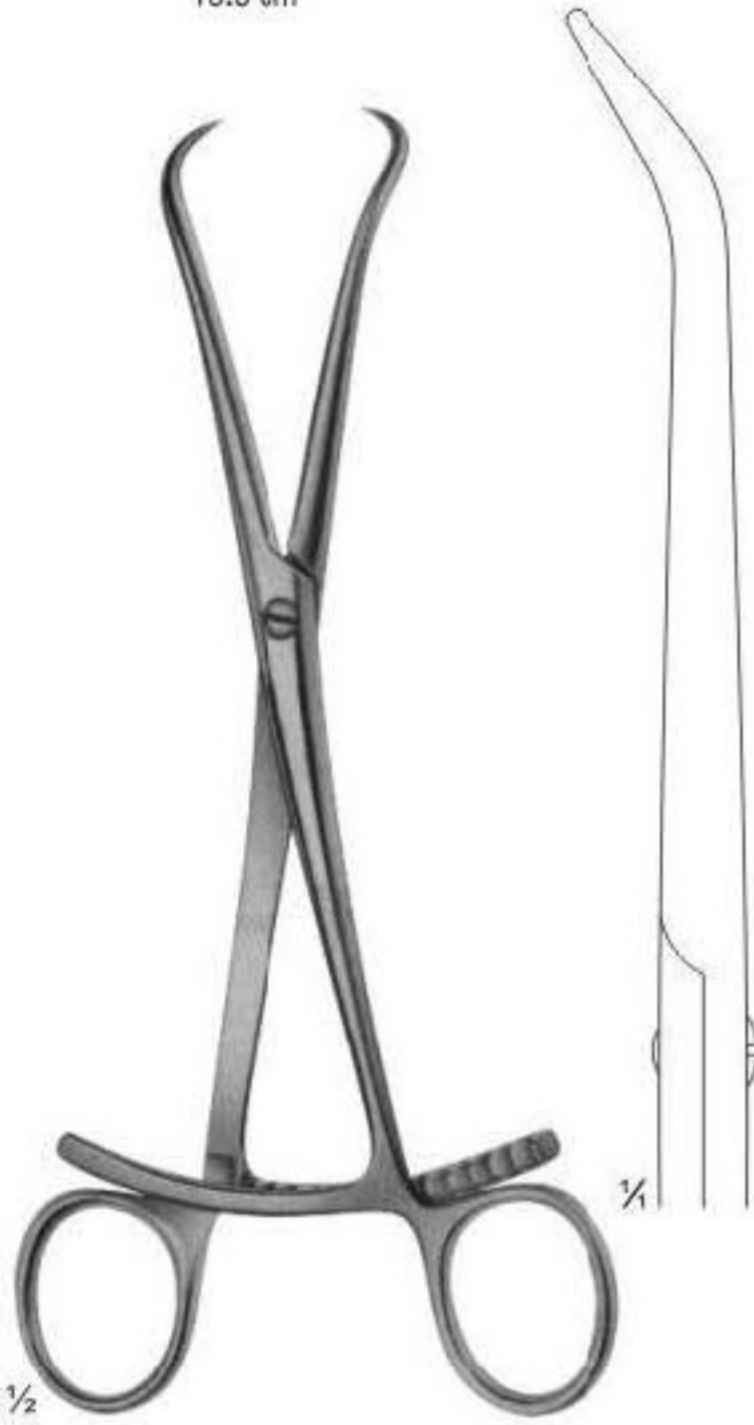

Repositioning forceps
17-1016
20.5 cm

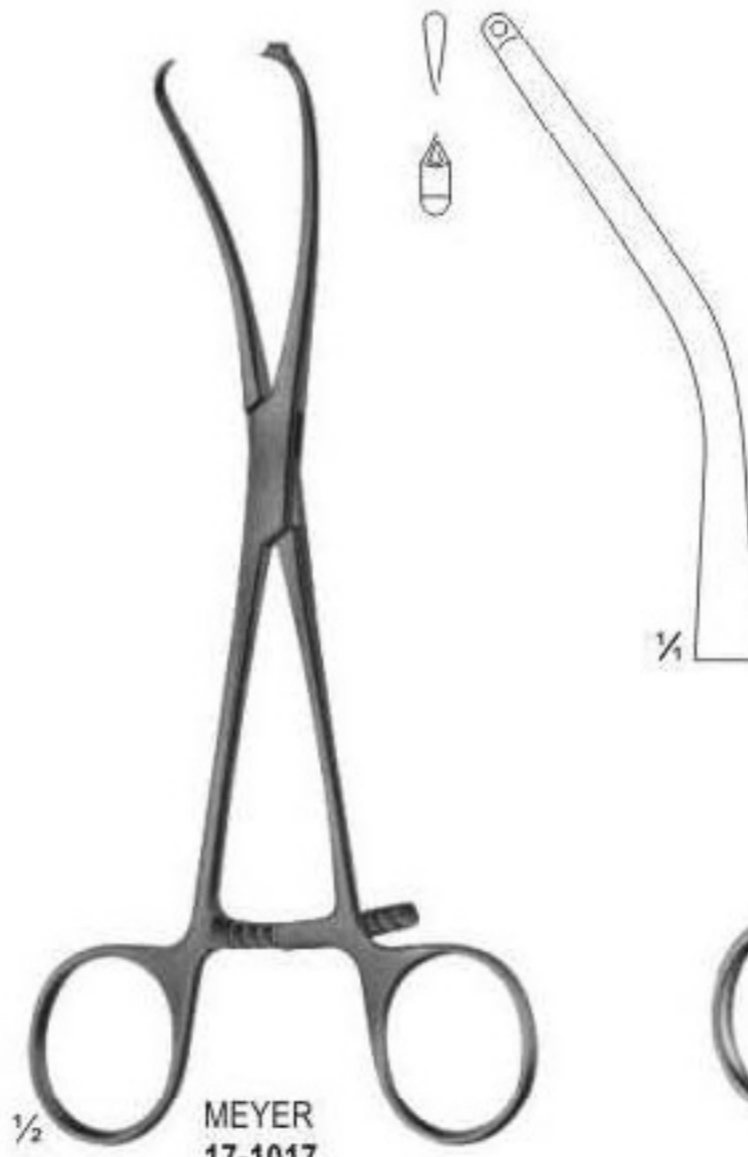

MEYER
17-1017
Repositioning forceps
for fingers, with drill
guide for KIRSCHNER
wires up to diam.1.0 mm
17 cm



LEWIN
17-1018
18 cm

Repositioning, Bone Holding Forceps



PATELLA FORCEPS
17-1019
18.5 cm



Forceps with
ratchet fixation
17-1020
14 cm



17-1021
12 cm



SETTER
17-1022
13.5 cm



SETTER
17-1023
17 cm



SETTER
17-1024
23.5 cm

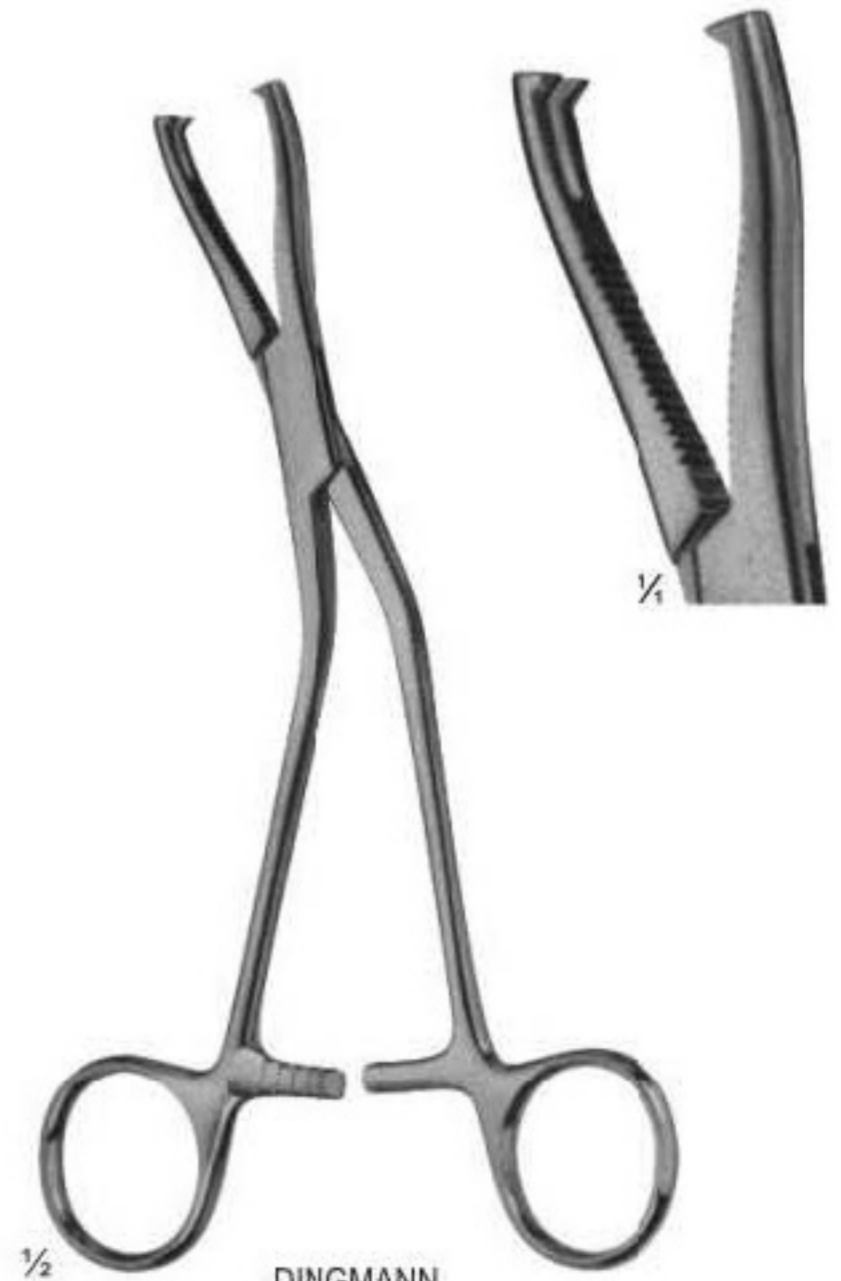

DINGMANN
17-1025
19 cm

Bone Holding Forceps

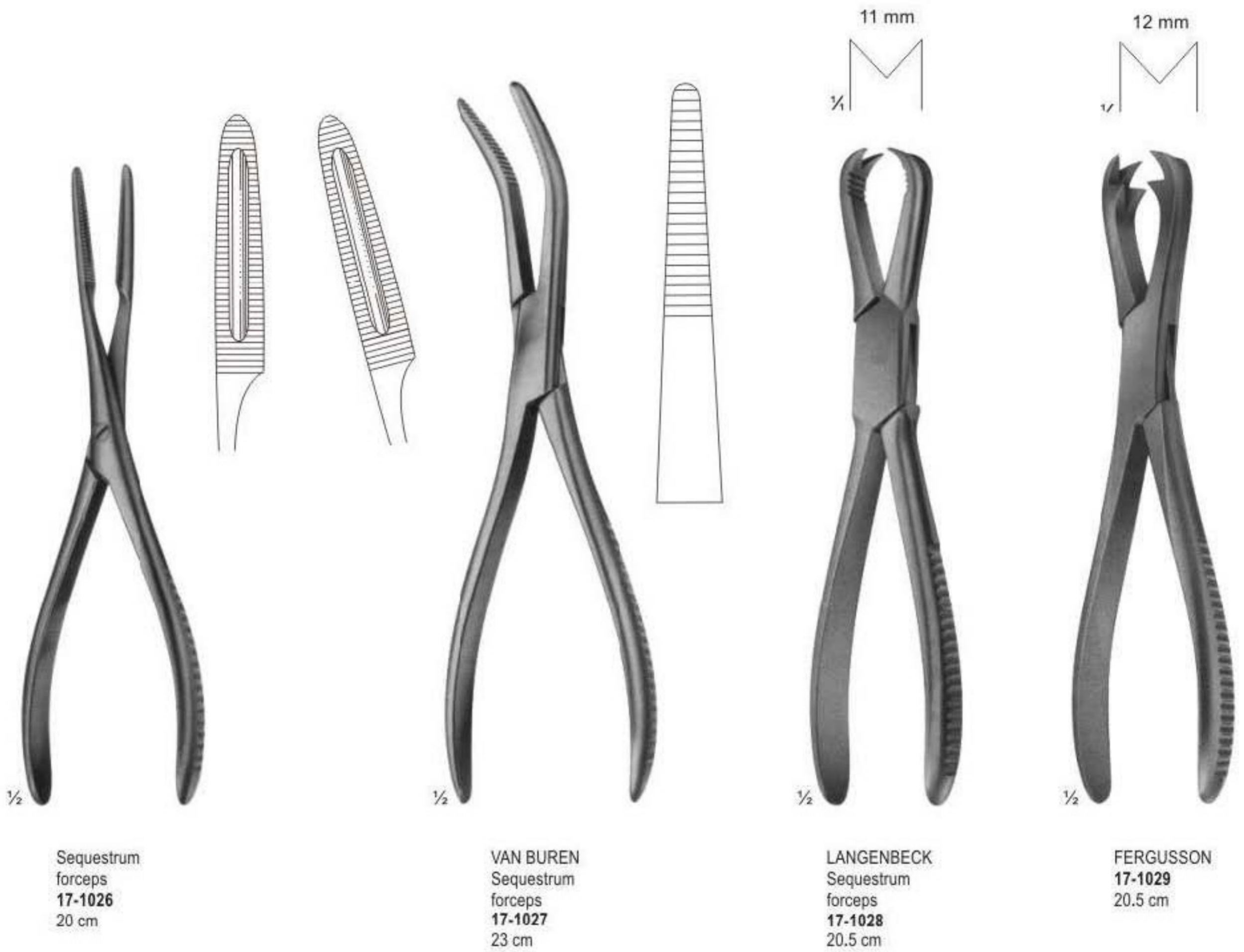

Sequestrum
forceps
17-1026
20 cm

VAN BUREN
Sequestrum
forceps
17-1027
23 cm

LANGENBECK
Sequestrum
forceps
17-1028
20.5 cm

FERGUSSON
17-1029
20.5 cm

Bone Holding, Repositioning Forceps

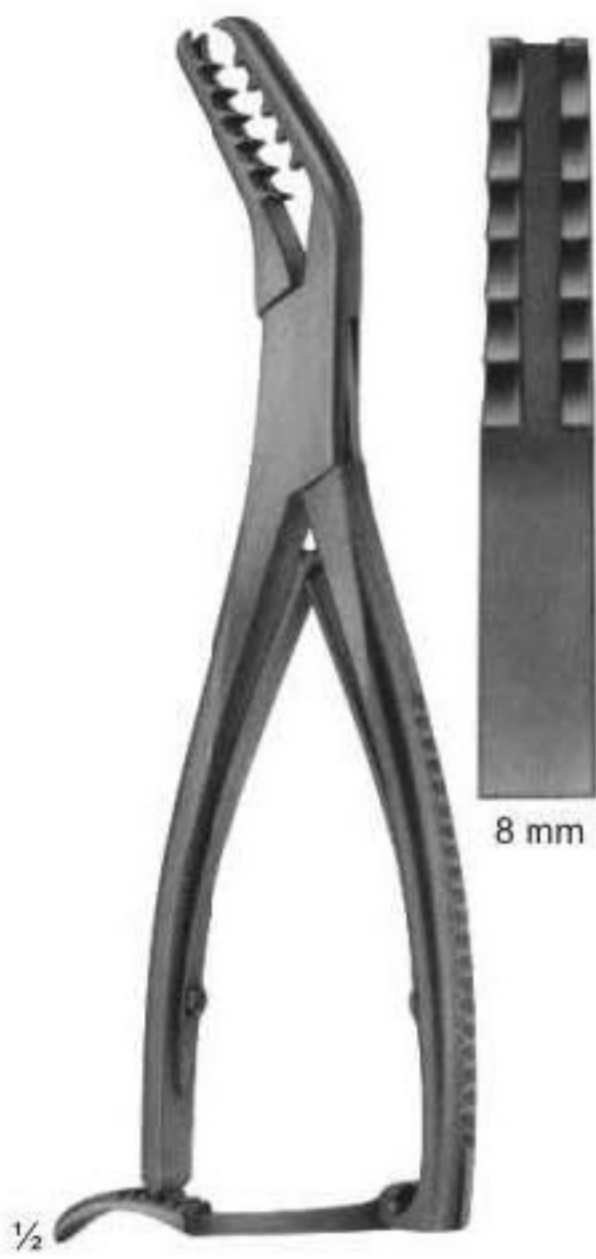

SEMB
17-1030
19 cm

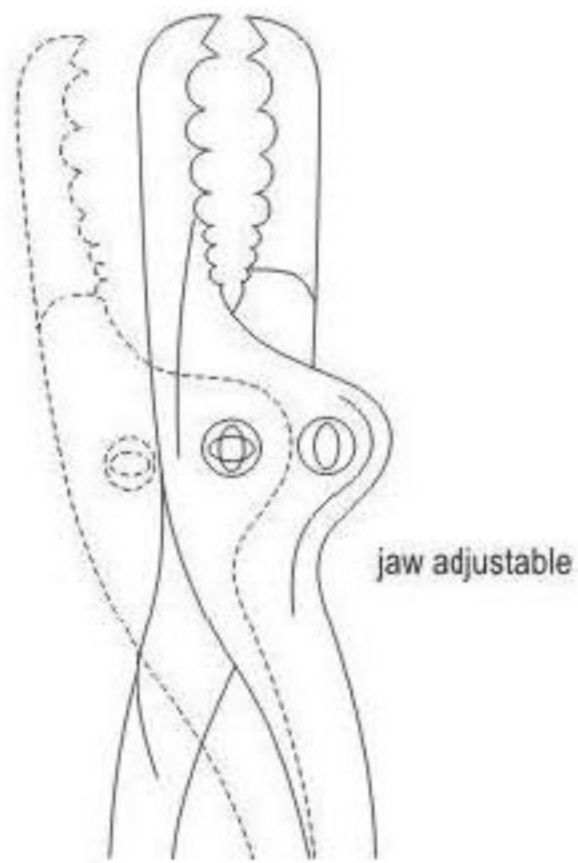

SEMB
17-1031
19.5 cm

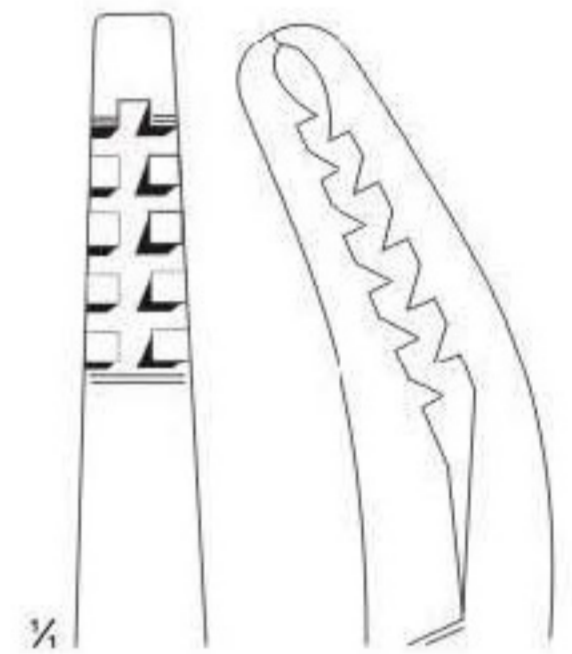

Bone Holding Forceps

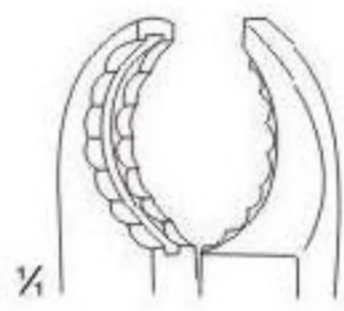
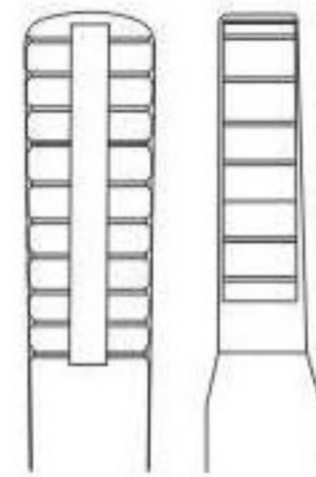
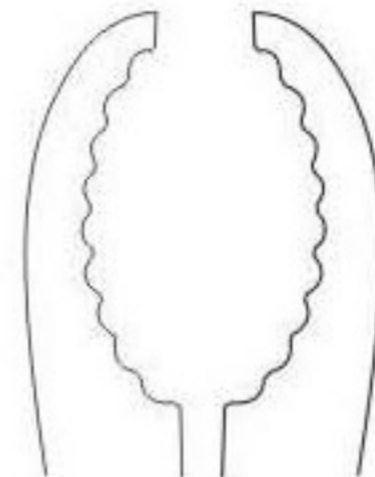
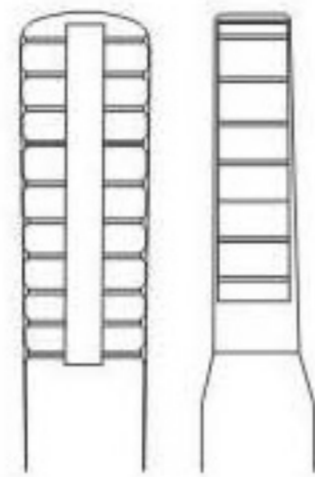
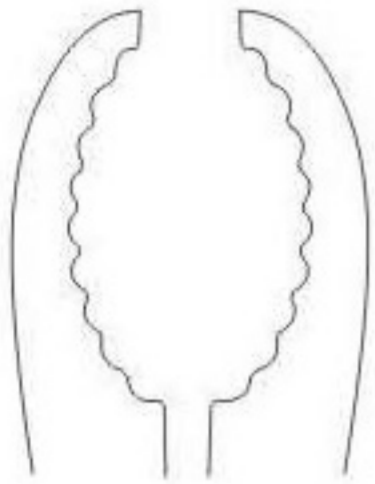

17-1032
23 cm

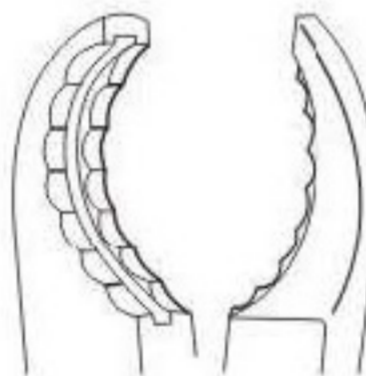

17-1033
25 cm

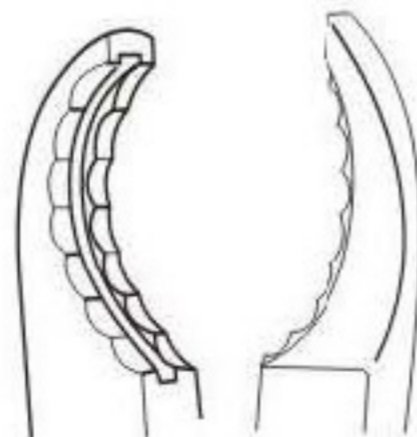

17-1034
28 cm

ULRICH
17-1032 - 17-1034
With thread Fixation

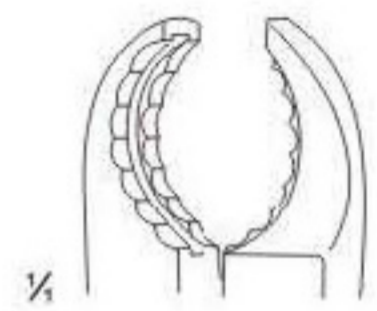

17-1035
23 cm

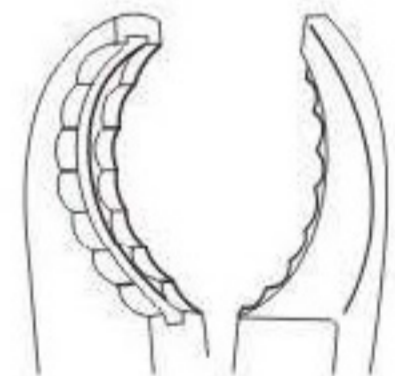

17-1036
25 cm

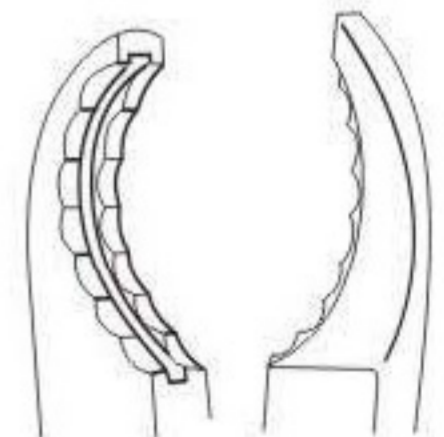

17-1037
27 cm

ULRICH
17-1035 - 17-1037
With thread Fixation

Bone Holding Forceps

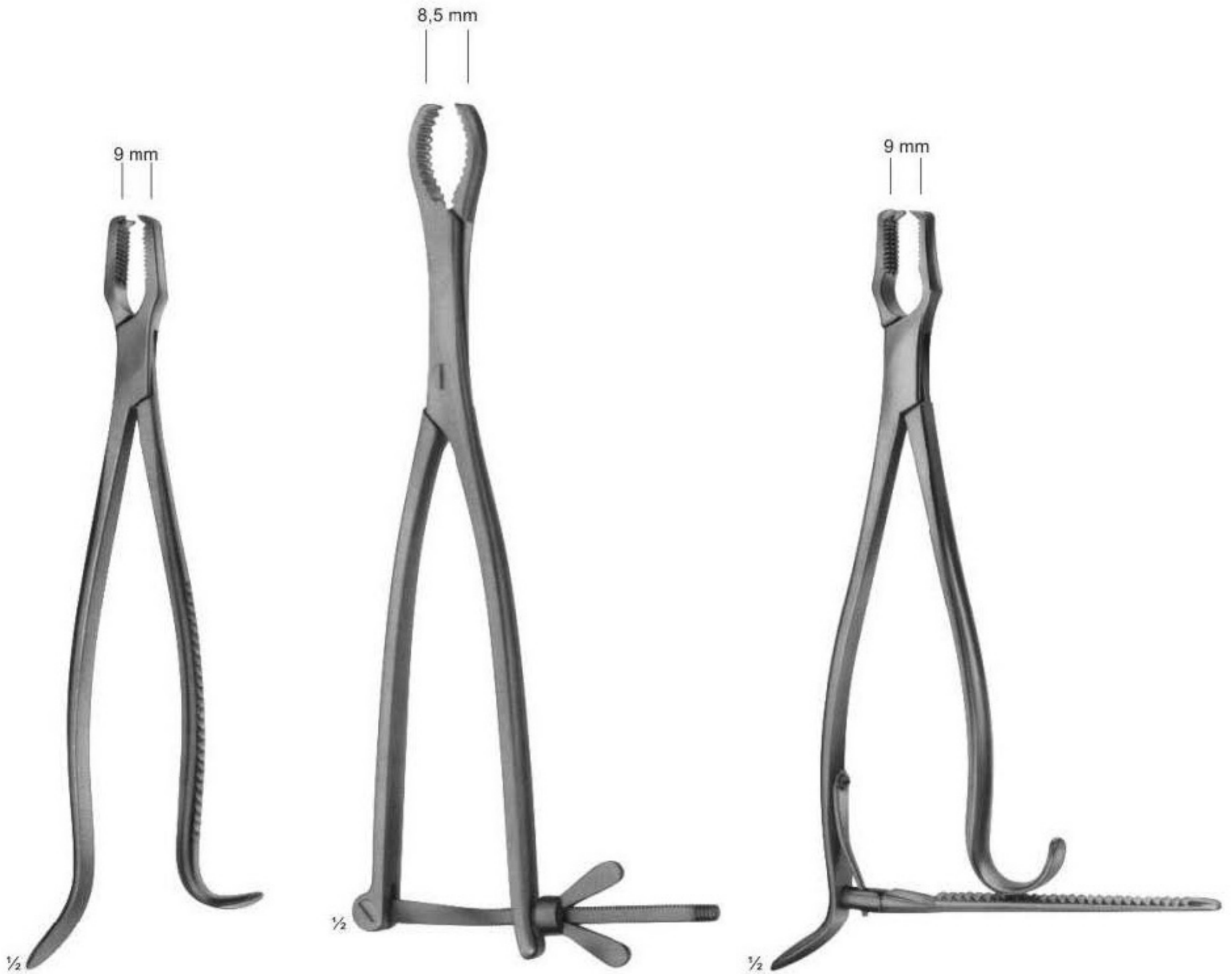

KERN-LANE
17-1038 - 17-1041
17-1038 14 cm
17-1039 17 cm
17-1040 21 cm
17-1041 24 cm

HEY GROVES
17-1042
30.5 cm

KERN-LANE
17-1043 - 17-1046
17-1043 14 cm
17-1044 17 cm
17-1045 21 cm
17-1046 24 cm

Bone Holding Forceps



FARABEUF
17-1047
23 cm



FARABEUF
17-1048
25.5 cm



FARABEUF-LAMBOTTE
17-1049
25.5 cm

Bone Holding Forceps



LANE
17-1050 - 17-1051
17-1050 33 cm
17-1051 45 cm



LANE
17-1052 - 17-1053
17-1052 33 cm
17-1053 45 cm

Bone Holding Forceps

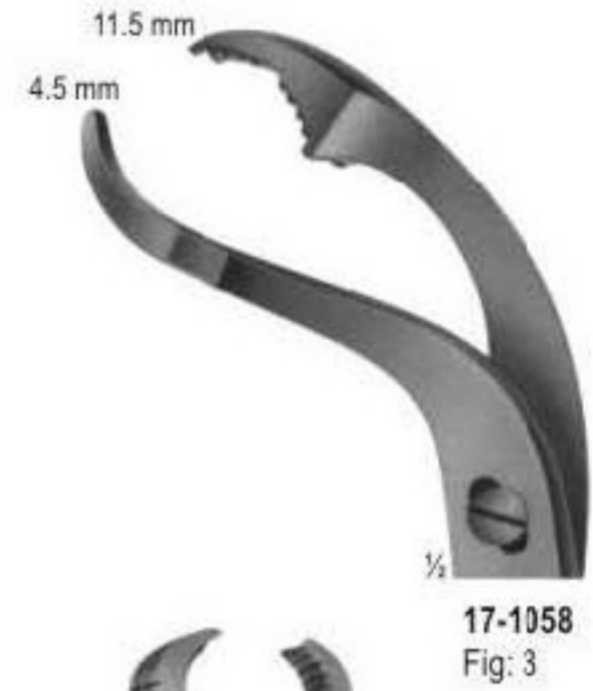
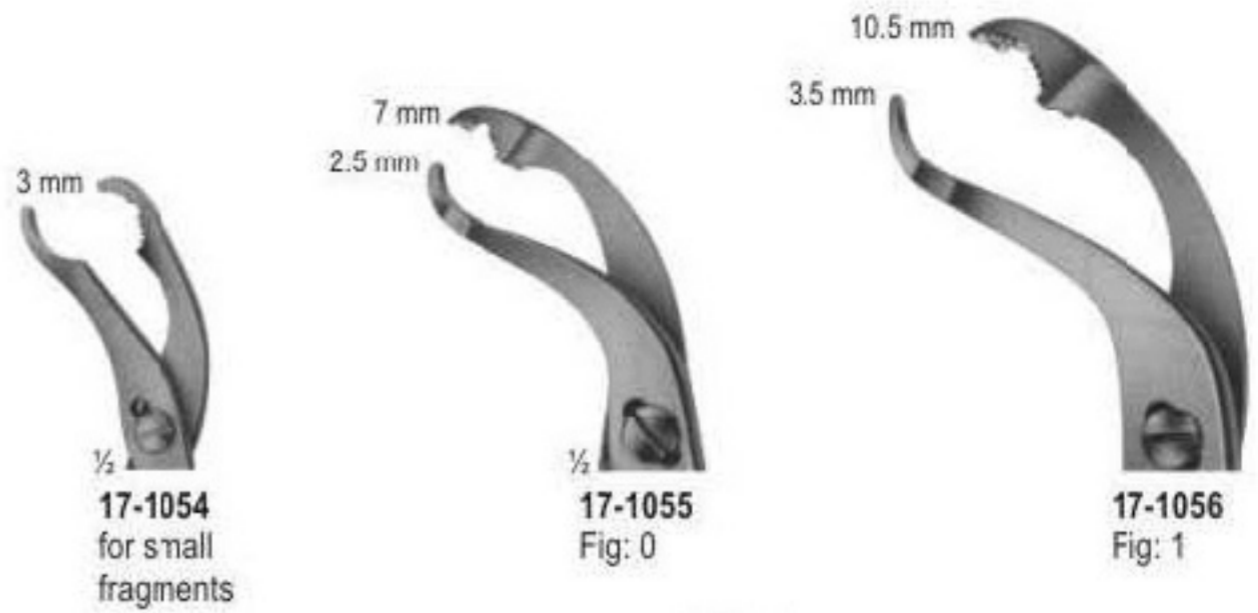

Meniscus-and Cartilage Forceps



BIRCHER
17-1063
20 cm



BIRCHER
17-1054
20 cm

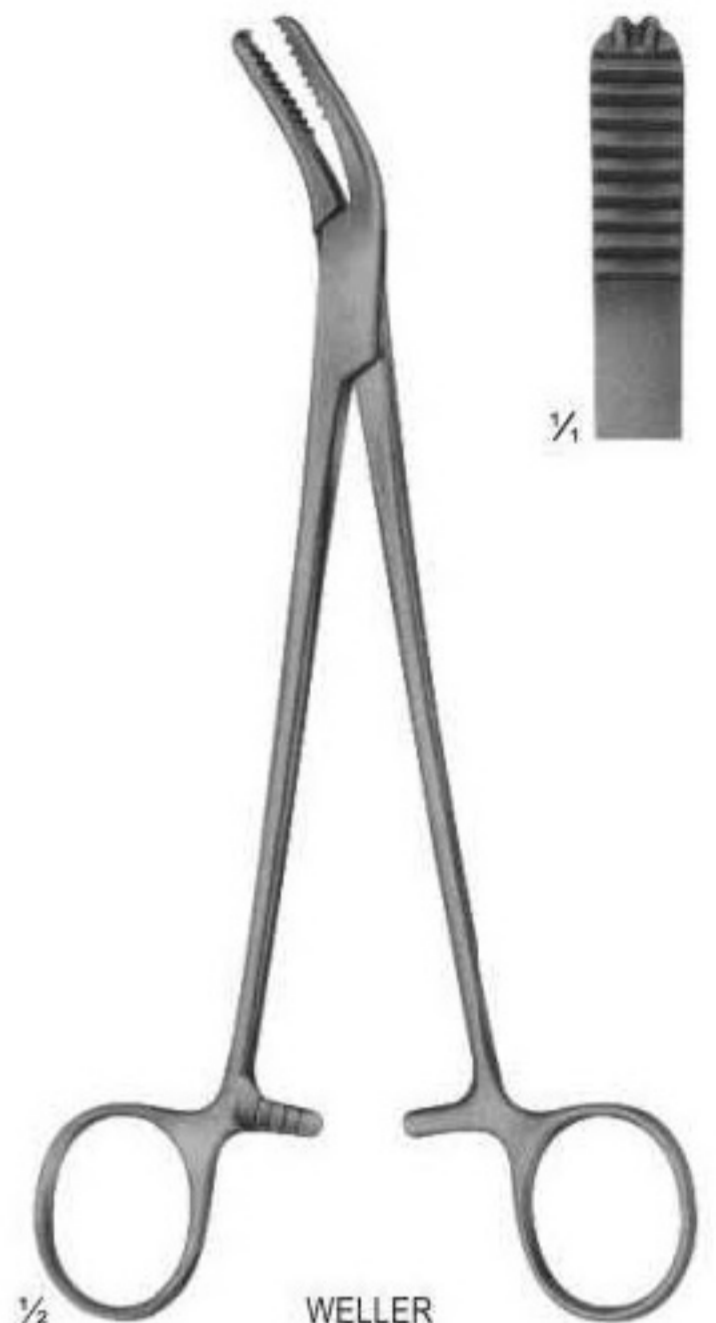

WELLER
17-1065
20 cm



BIRCHER-GANSKE
17-1066
20 m



BIRCHER-GANSKE
17-1067
20 cm



MARTIN
17-1068
20.5 cm

Bone Clamps



LOW/MAN
17-1069 - 17-1070
17-1069 17 cm
17-1070 20.5 cm



LOWMAN-GERSTER
17-1071
21 cm



LOWMAN-HOGLUND
17-1072
17.5 cm

Wire Holding Forceps, Flat-nosed Pliers, Pliers For Bending And Cutting Wires



17-1073
13 cm



17-1074
18 cm



Extraction pliers
for boring wires
17-1073 - 17-1074



Flat-nosed pliers,
parallel
17-1075
18.5 cm

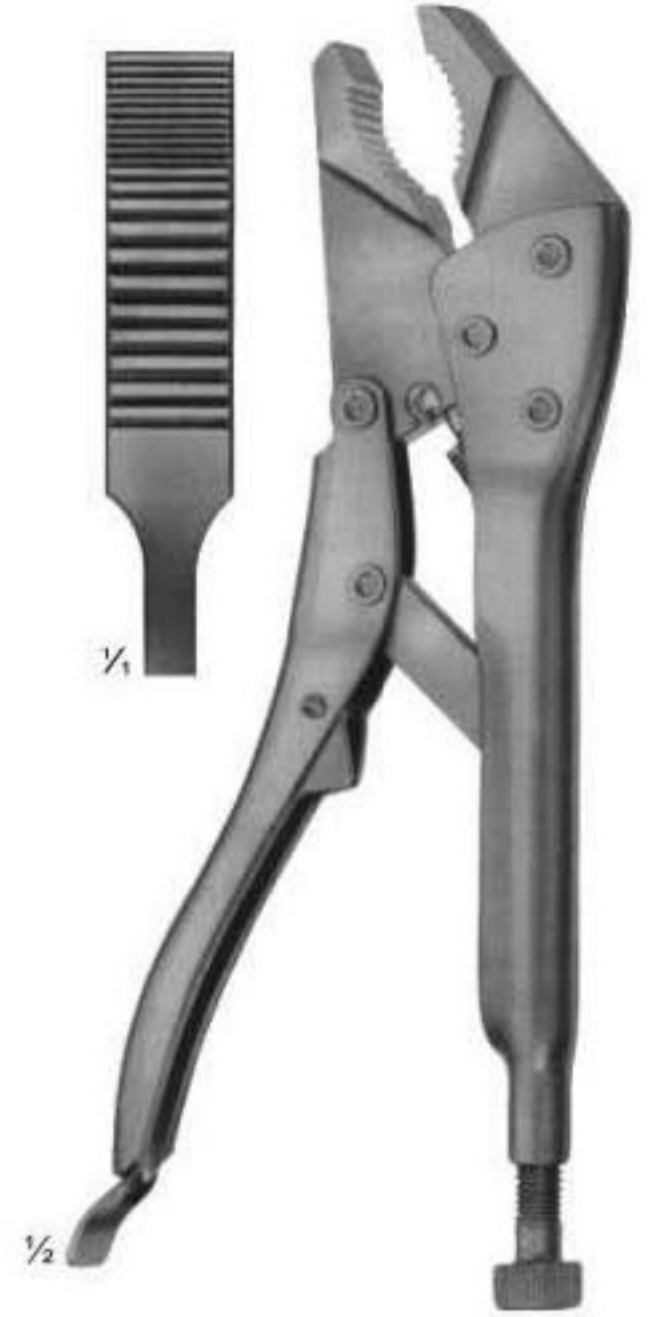

Vise grip
17-1076
20 cm



Round pliers
17-1077 - 17-1081
18 cm



17-1077



17-1078



17-1079



17-1080



17-1081

17-1077
17-1078 14.5 cm
17-1079 18 cm
17-1080 18 cm
17-1081 18 cm
Extraction pliers for wires



Bending pliers
for wires up to
1.8 mm diam
17-1082

Synovectomy-Rongeurs, Bone Rongeurs

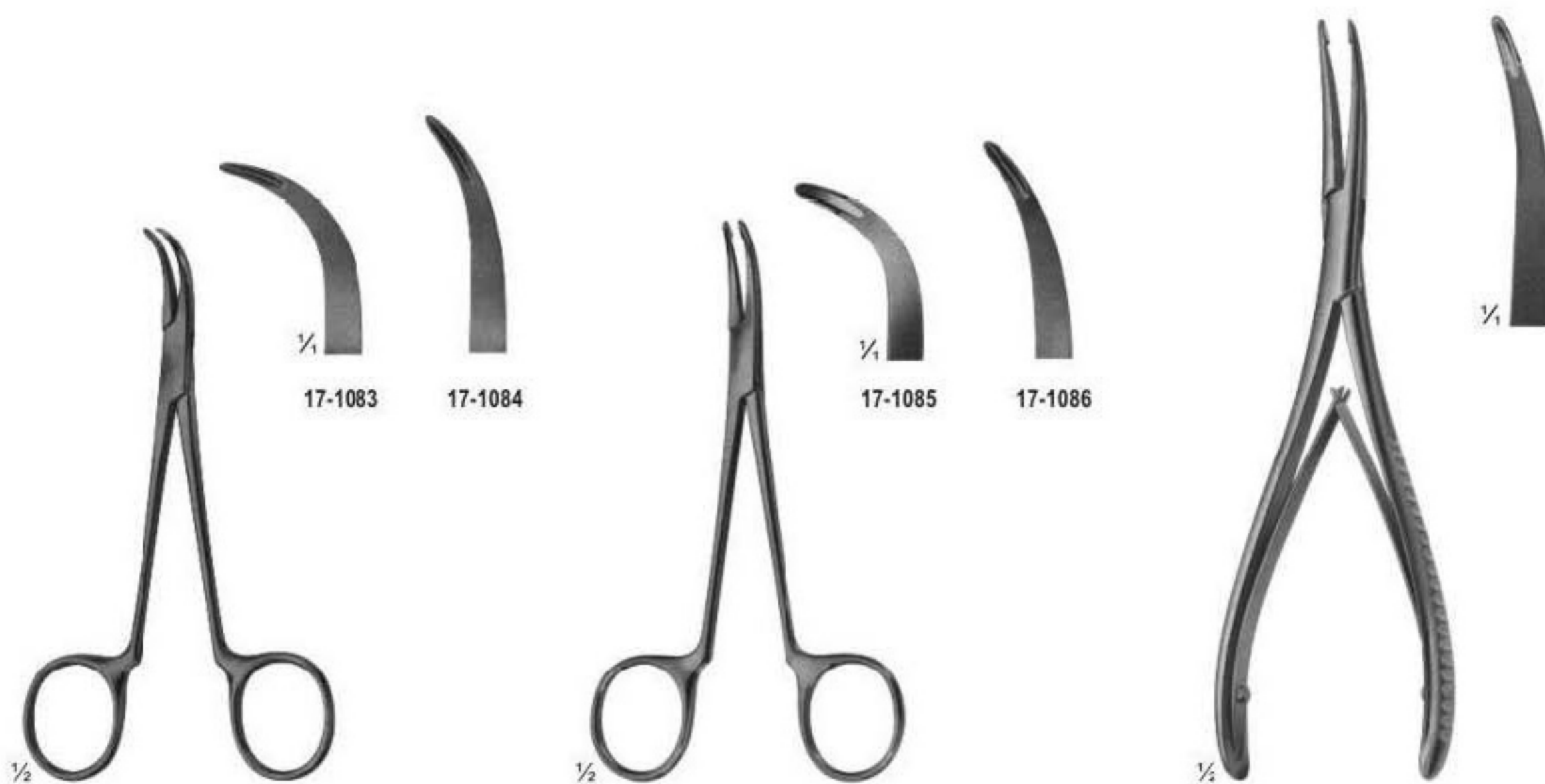

Synovectomy rongeur
width of jaws 1.2 mm
17-1083 - 17-1084
13 cm

Synovectomy rongeur
width of jaws 2.0 mm
17-1085 - 17-1086
13 cm

STELLBRINK
Synovectomy rongeur
17-1087
17.5 cm

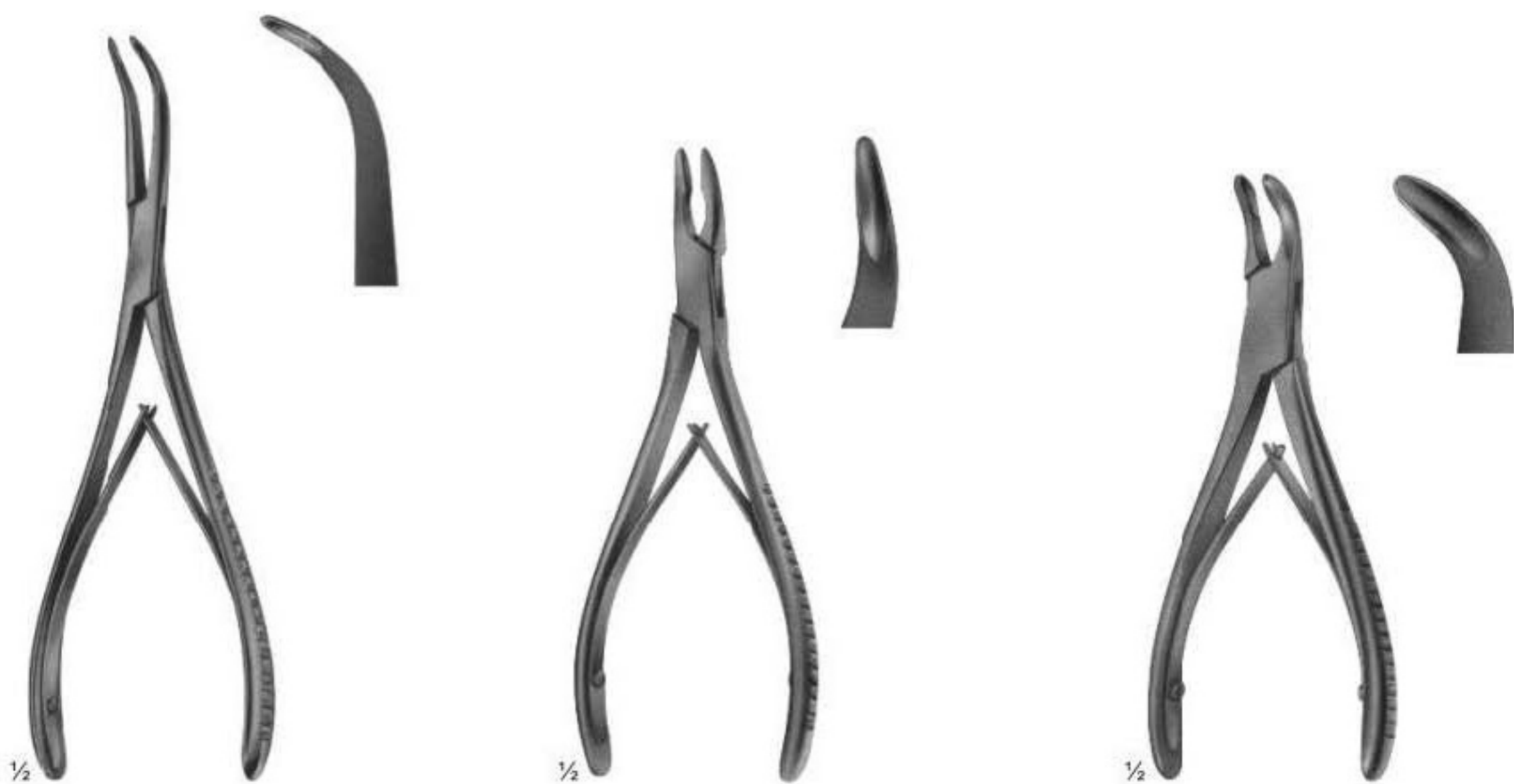

STELLBRINK
Synovectomy rongeur
17-1088
17 cm

LUER-FRIEDMANN
17-1089
14.5 cm

17-1090
14 cm

Bone Rongeurs



LUER
17-1091
15 cm



LUER
17-1092
15.5 cm



BLUMENTHAL
17-1093
15.5 cm



BLUMENTHAL
17-1094
15 cm



JANSEN
17-1095 - 17-1096
17.5 cm



17-1096

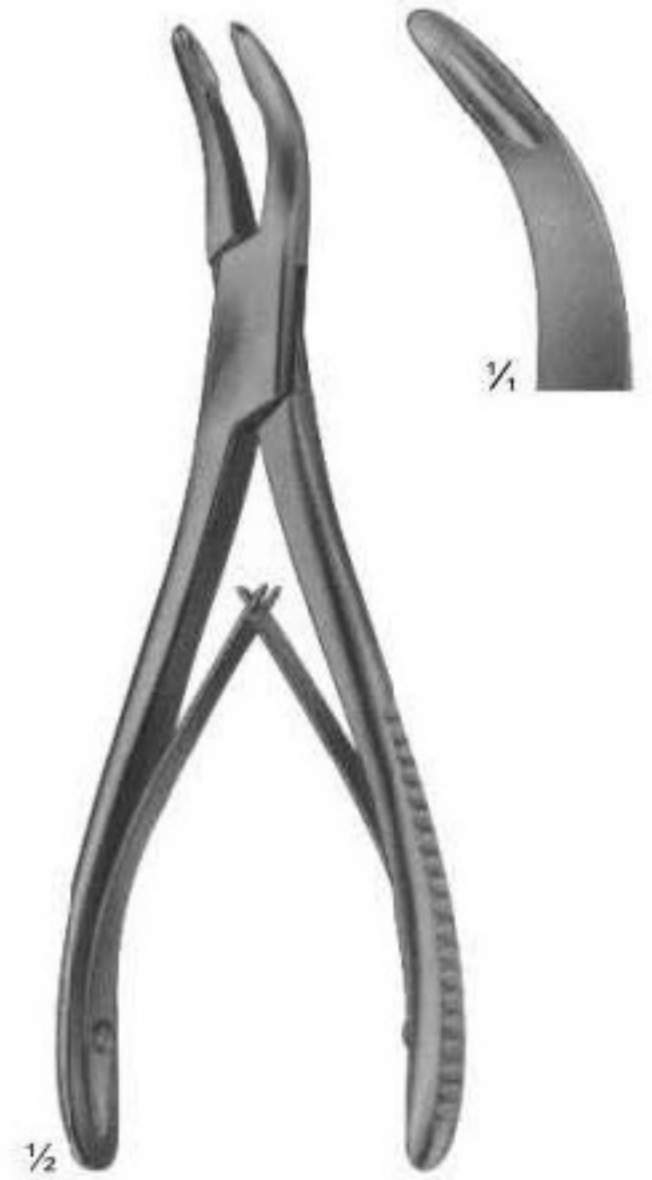

BANE-HARTMANN
17-1097
17.5 cm

Bone Rongeurs



ALEXANDER
17-1098
14 cm

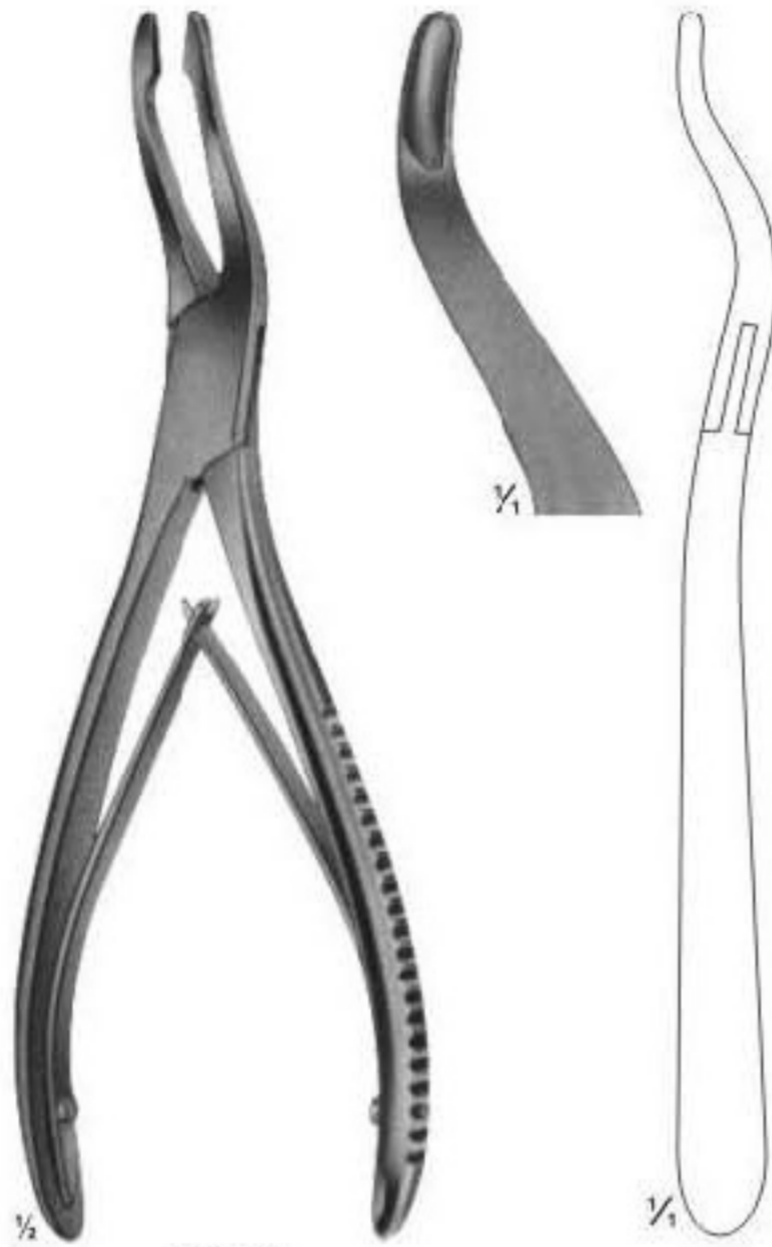

JANSEN
17-1099
19 cm

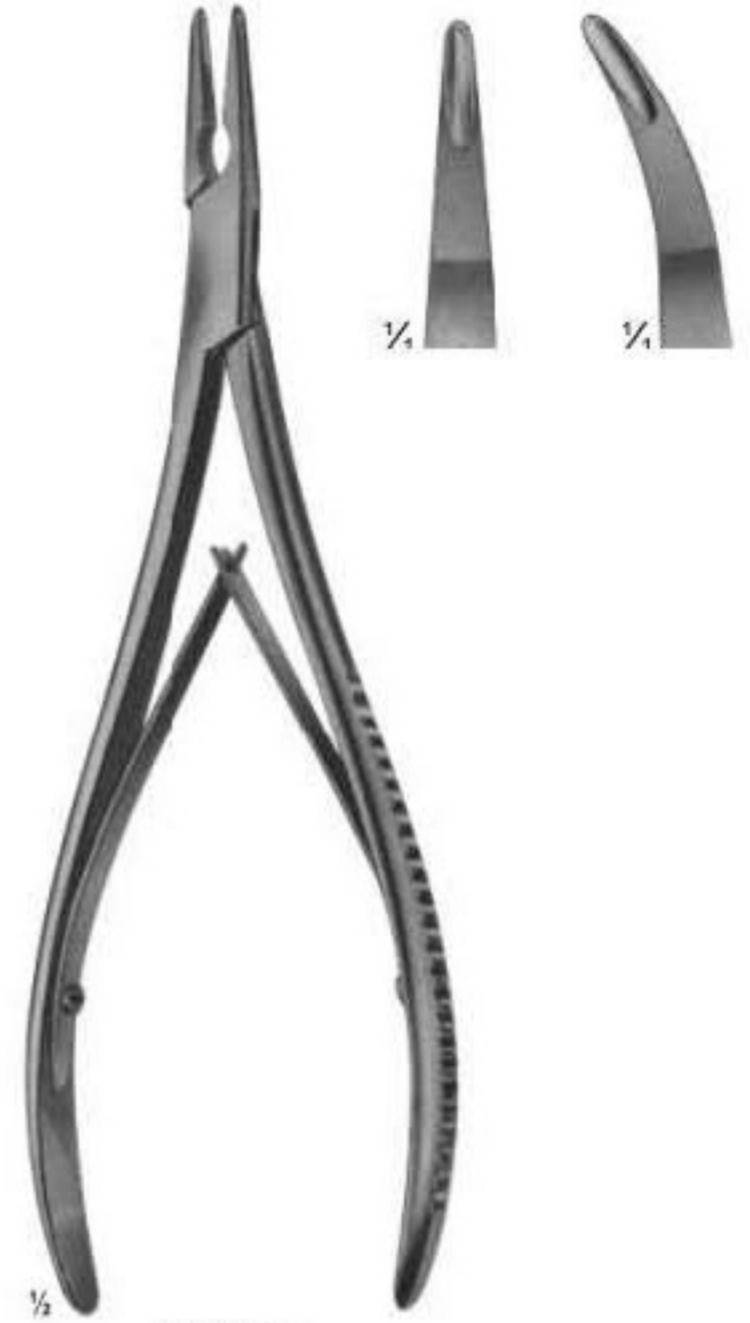

LEMPERT
17-1100
20 cm



BEYER
17-1101
18 cm

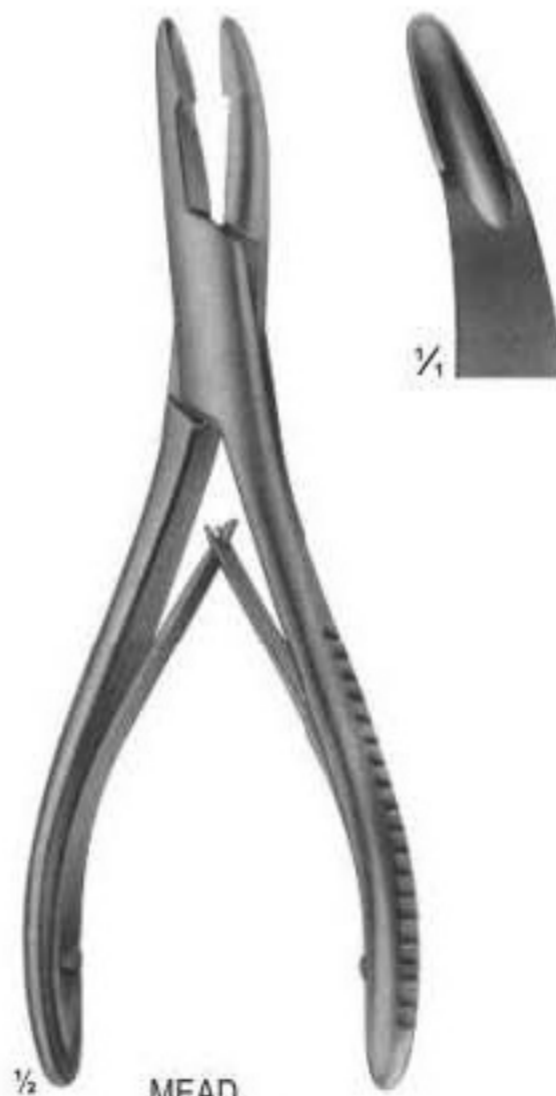

MEAD
17-1102
16.5 cm



MEAD
17-1103
16.5 cm

Bone Rongeurs



17-1104



17-1105



LUER
17-1106
18 cm



LUER
17-1107
18 cm



OLIVECRONA
17-1108
20.5 cm



BOHLER
17-1109
15.5 cm



MARQUARTD
17-1110
20 cm

Bone Rongeurs



STILLE
17-1111
23.5 cm



LEKSELL-STILLE
17-1112
24 cm



STILLE-RUSKIN
17-1113
24 cm

Bone Rongeurs

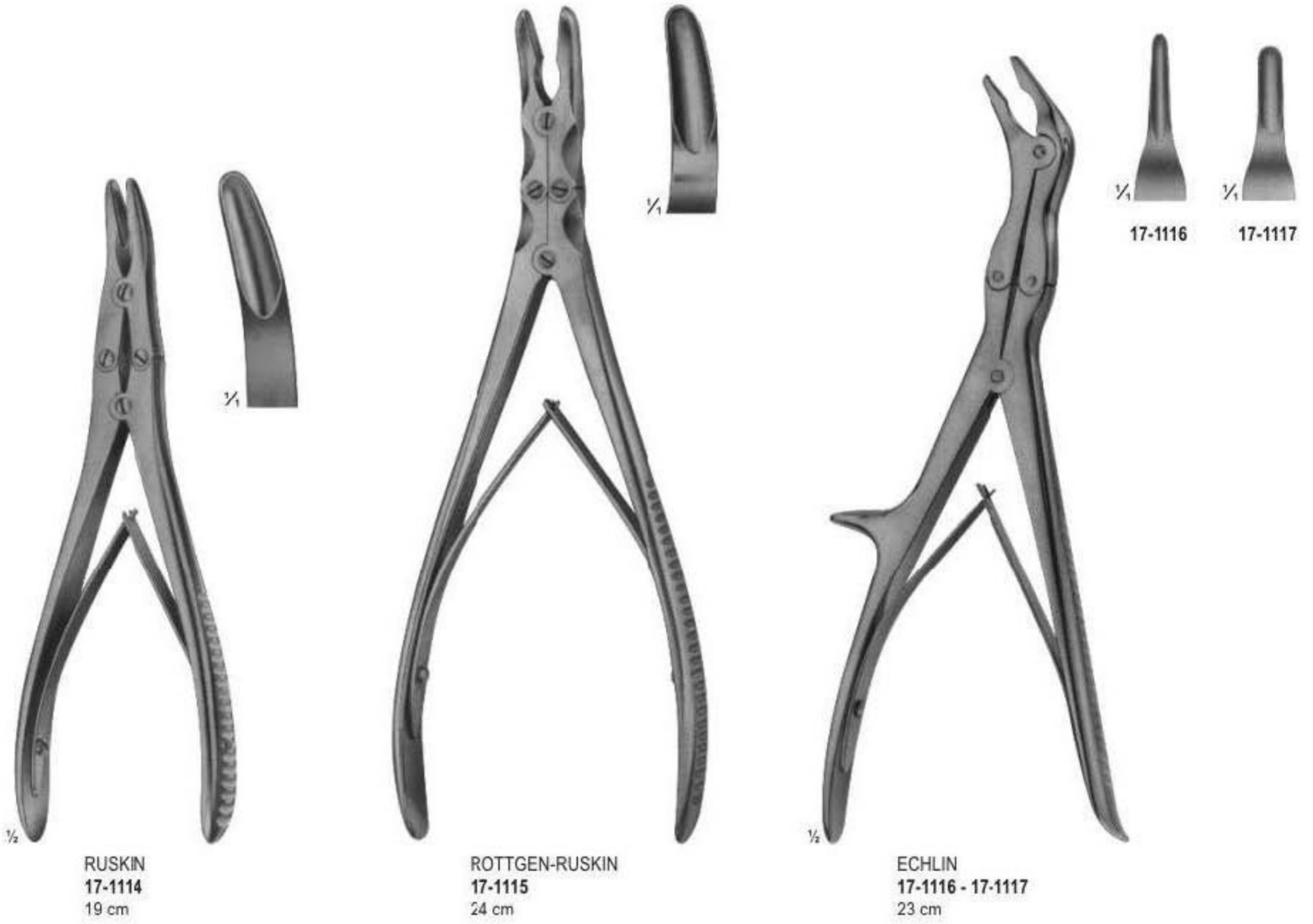

Bone Rongeurs



Bone Rongeurs



17-1120
LUER-STILLE
22.5 cm



17-1121
LUER-STILLE
22.5 cm



Mallets



HAJEK
140 g
17-1122
21.5 cm



17-1123
215 g
with interchangeable
plastic disks
24.5 cm
17-1124
pair of spare disks

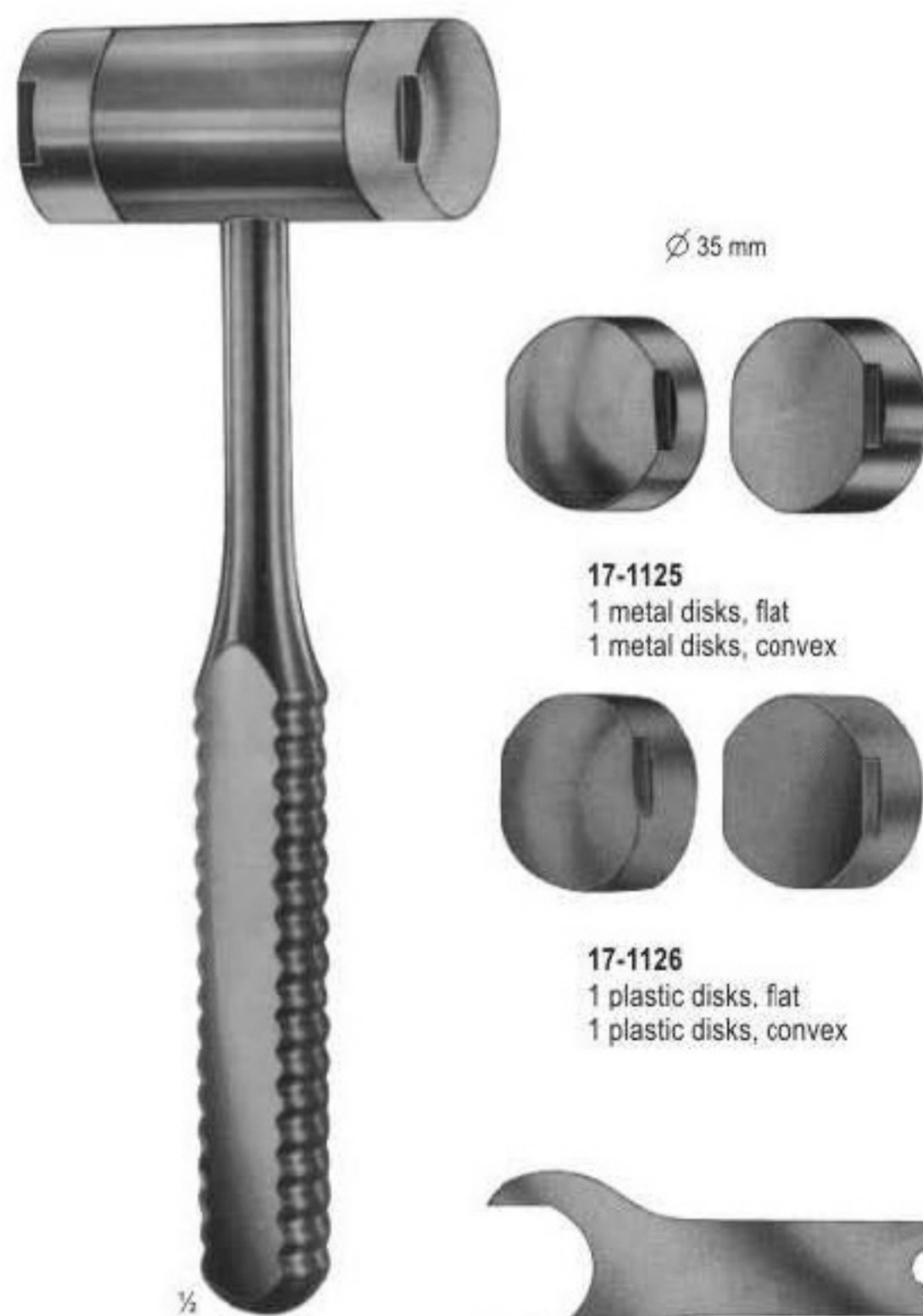

WAGNER
complete with:
1 pair of metal disks and
1 pair of plastic disks and
1 wrench 566
17-1125 - 17-1127
23.5 cm



Wrench
17-1127

Mallet without disks 130 g

Mallets



BERGMANN
17-1128
24.5 cm



BERGMANN
17-1129
23.5 cm



OMBREDANNE
17-1130
24 cm



HEATH
copper filled head
700 g
17-1131
18.5 cm

Mallets



½

PARTSCH
17-1132
With Hollow Handle
19 cm

Weight 175 g Head ∅ 27 mm



VIKERS
17-1133
19 cm

Weight 185 g Head ∅ 25 mm



HERBERT
17-1134
For Ulna Head Prosthesis
19 cm

Weight 215 g Head ∅ 25 mm

Mallets



MEAD
17-1135
185 g
with interchangeable
plastic cisks
19 cm
17-1136
pair of spare disks



17-1137
140 g
with interchangeable
plastic disks
18.5 cm
17-1138
pair of spare disks



COTTLE
17-1139
140 g
1 Side convex
18.5 cm



17-1140
165 g
lead filled head
19 cm

Mallets



COLLIN
17-1141
20 cm

Weight 220 g Head
 ∅ 30 mm



LUCAE
17-1142 - 17-1143
19.5 cm

17-1142
Weight 230 g Head
 ∅ 19 mm
17-1143
Weight 260 g Head
 ∅ 25 mm



WILLIGER
17-1144
16.5 cm

Weight 140 g Head
 ∅ 20 mm

Mallets



WILLIGER
17-1145 - 17-1147
Lead Filled

17-1145	
Weight	Head
275 g	∅ 26 mm
17-1146	
Weight	Head
320 g	∅ 28 mm
17-1147	
Weight	Head
340 g	∅ 30 mm



DOYEN
17-1148 - 17-1150

17-1148	
Weight	Head
120 g	∅ 25 mm
17-1149	
Weight	Head
180 g	∅ 30 mm
17-1150	
Weight	Head
260 g	∅ 35 mm

Wire Cutting Pliers



17-1151
32 cm

for soft wire
up to diam. 3 mm
For hard wire
up to diam 3 mm

Cutter for cutting off
KIRSCHNER wires,
Tibia head screws,
bolts, pins, up to 3 mm diam.



Durotip

17-1152
Cutter for cutting off
KIRSCHNER wires,
Tibia head screws,
bolts, pins, up to 6 mm diam.
47 cm

Wire Cutting Pliers, Lateral Cutting Action



17-1153
18 cm

for soft wire
up to diam. 2,0 mm
For hard wire 1,5 mm
up to diam
specially hardened
cutting edges, front
and lateral cutting
action



REILL
17-1154
17.5 cm

for soft wire
up to diam. 2,0 mm
For hard wire 1,6 mm
up to diam
specially hardened
cutting edges, for
cutting off wires close
to the bone



17-1155
23.5 cm

for soft wire
up to diam. 3,0 mm
For hard wire 2,2 mm
up to diam

Wire Cutting Pliers, Lateral And Front Cutting Action



17-1156
24 cm

for soft wire
up to diam. 2 mm
For hard wire
up to diam. 1.6 mm

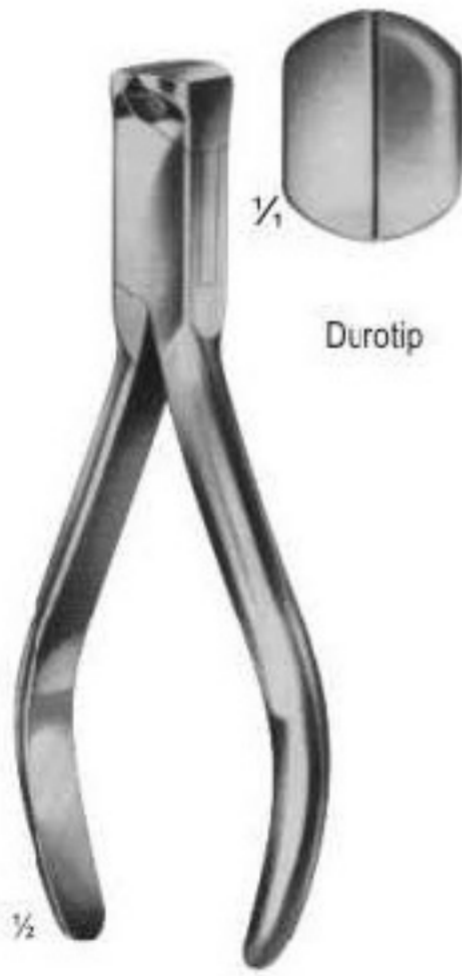

17-1157
14 cm

for soft wire
up to diam. 1.5 mm
For hard wire
up to diam. 1 mm



17-1158
14.5 cm

for soft wire
up to diam. 2 mm
For hard wire
up to diam. 1.5 mm



17-1159
22 cm

for soft wire
up to diam. 3.5 mm
For hard wire
up to diam. 2.5 mm

Osteotomes, Gouges



17-1160
18 cm
6 mm



17-1161
18 cm
6 mm

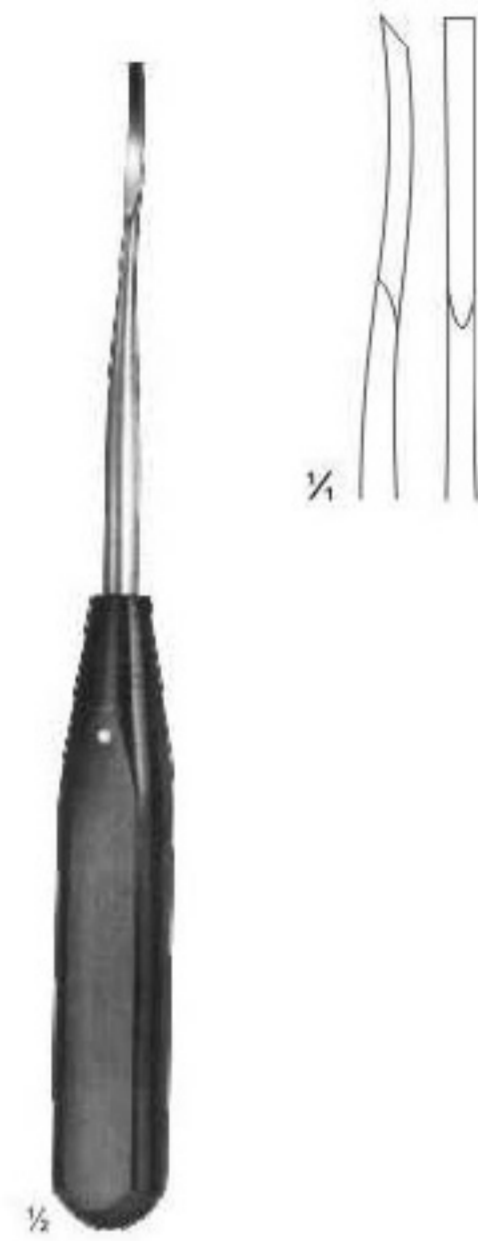

17-1162
18 cm
3 mm

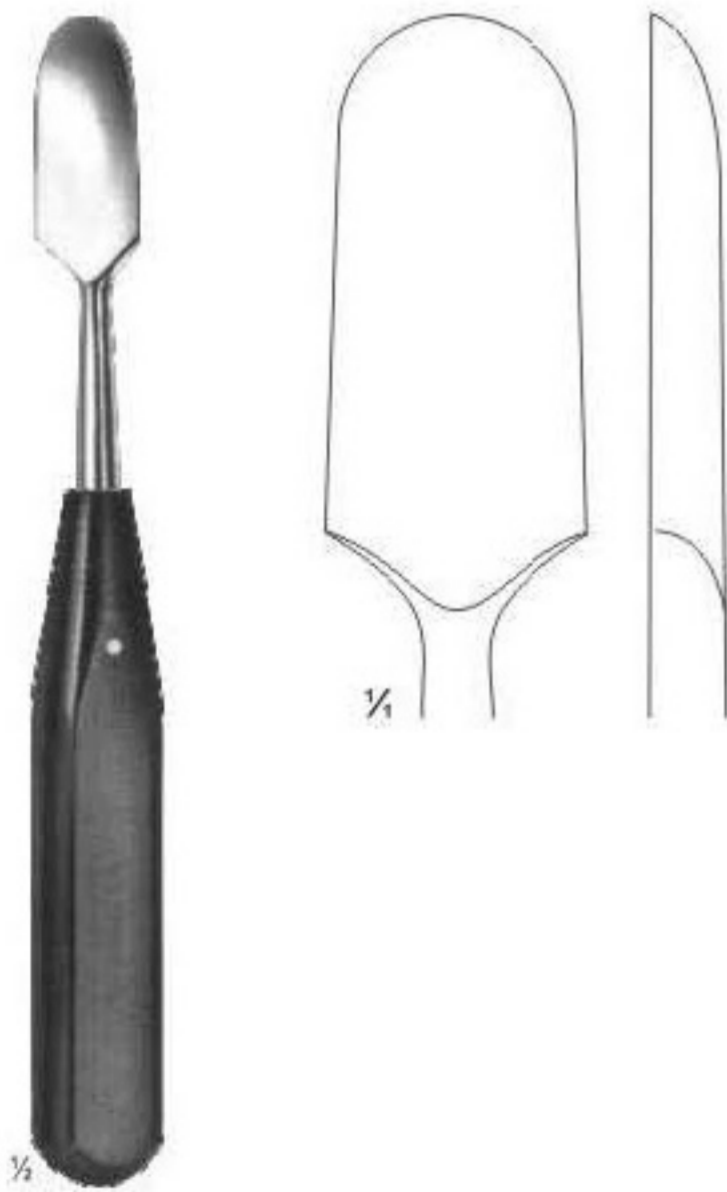

17-1163
18 cm
20 mm



17-1164
20 cm
14 mm

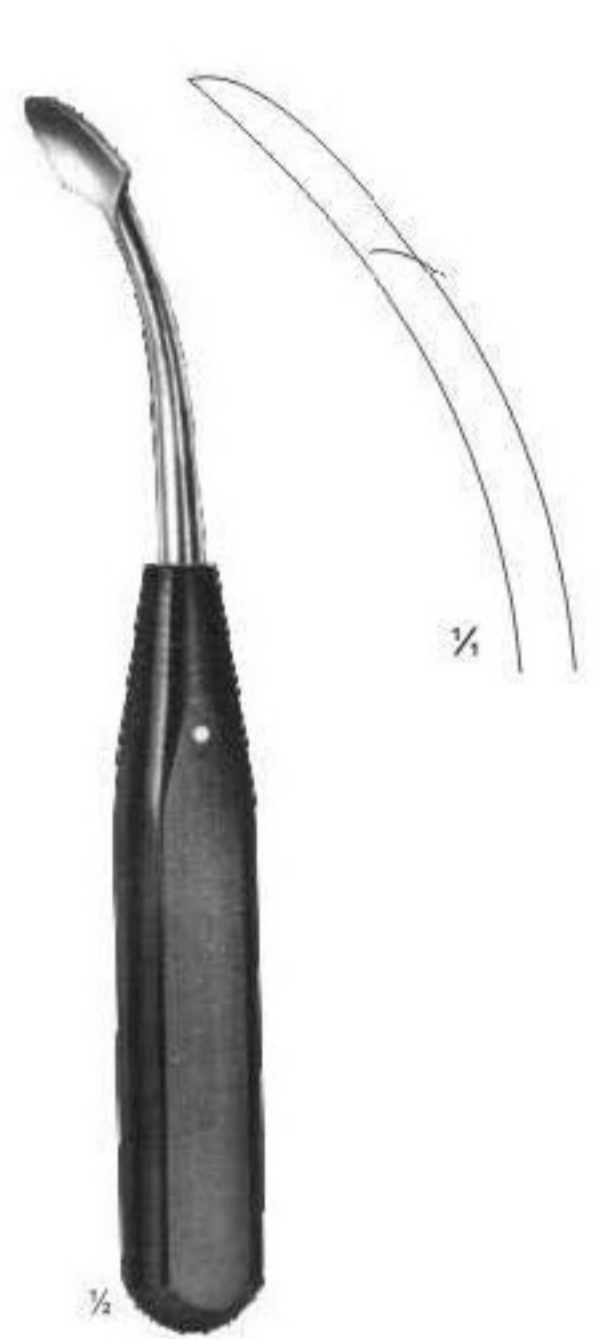

17-1165
19 cm
14 mm

Osteotomes, Gouges

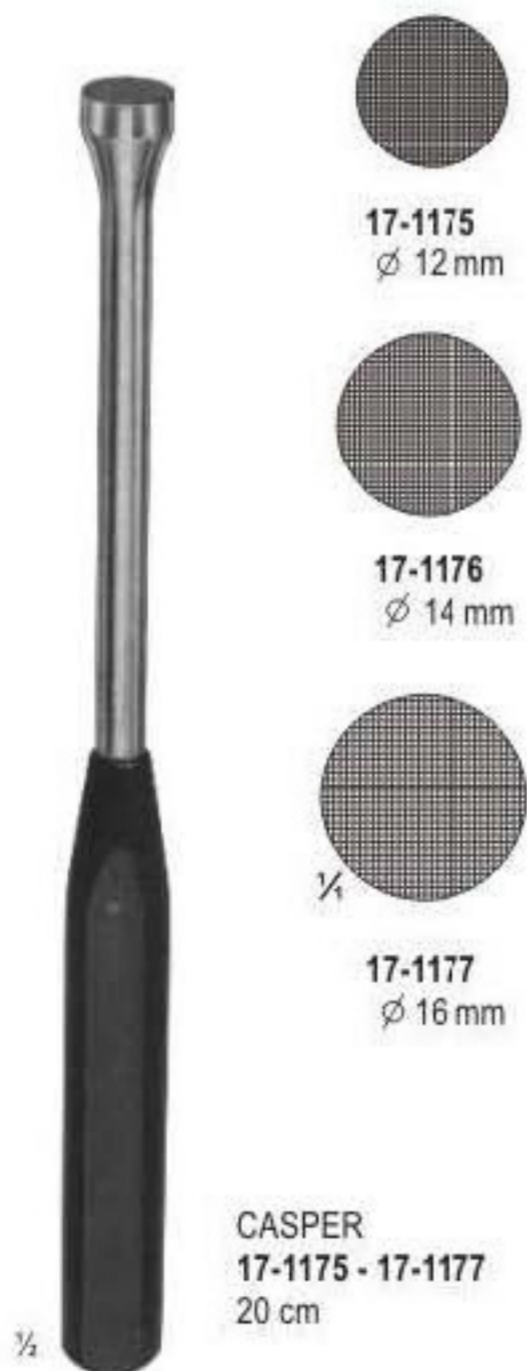

Osteotomes, Gouges

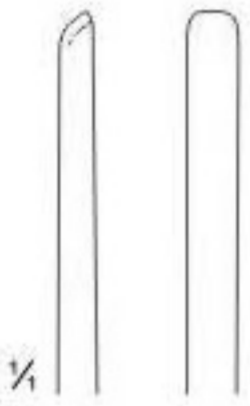

17-1182 5 mm
17-1183 10 mm
17-1184 15 mm

LEXER
17-1182 - 17-1184
24.5 cm

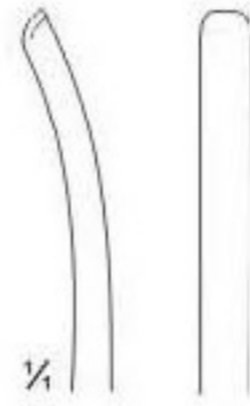

17-1185 5 mm
17-1186 10 mm
17-1187 15 mm

LEXER
17-1185 - 17-1187
24.5 cm



17-1188 4 mm
17-1189 6 mm
17-1190 8 mm
17-1191 10 mm
17-1192 12 mm

LEXER-MINI
17-1188 - 17-1192
18 cm

Osteotomes, Gouges

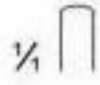

- 17-1193 4 mm
- 17-1194 6 mm
- 17-1195 8 mm
- 17-1196 10 mm
- 17-1197 12 mm

LEXER-MINI
17-1193 - 17-1197
18 cm

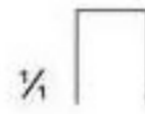

- 17-1198 7 mm
- 17-1199 10 mm
- 17-1200 15 mm
- 17-1201 20 mm
- 17-1202 25 mm
- 17-1203 30 mm

LEXER
17-1198 - 17-1203
22 mm



- 17-1204 7 mm
- 17-1205 10 mm
- 17-1206 15 mm
- 17-1207 20 mm
- 17-1208 25 mm
- 17-1209 30 mm

LEXER
17-1204 - 17-1209
22 mm

Bone Cutting Forceps



STAMM
17-1210
15 cm



KAZANJIAN
17-1211
18.5 cm



17-1212
14 cm



17-1213
17 cm



17-1216
17 cm

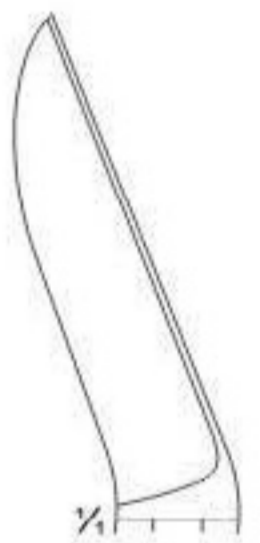

17-1217
20 cm



17-1214
20 cm



17-1215
22 cm



17-1218
22 cm

LISTON
17-1212 - 17-1215

LISTON
17-1216 - 17-1218

Bone Cutting Forceps

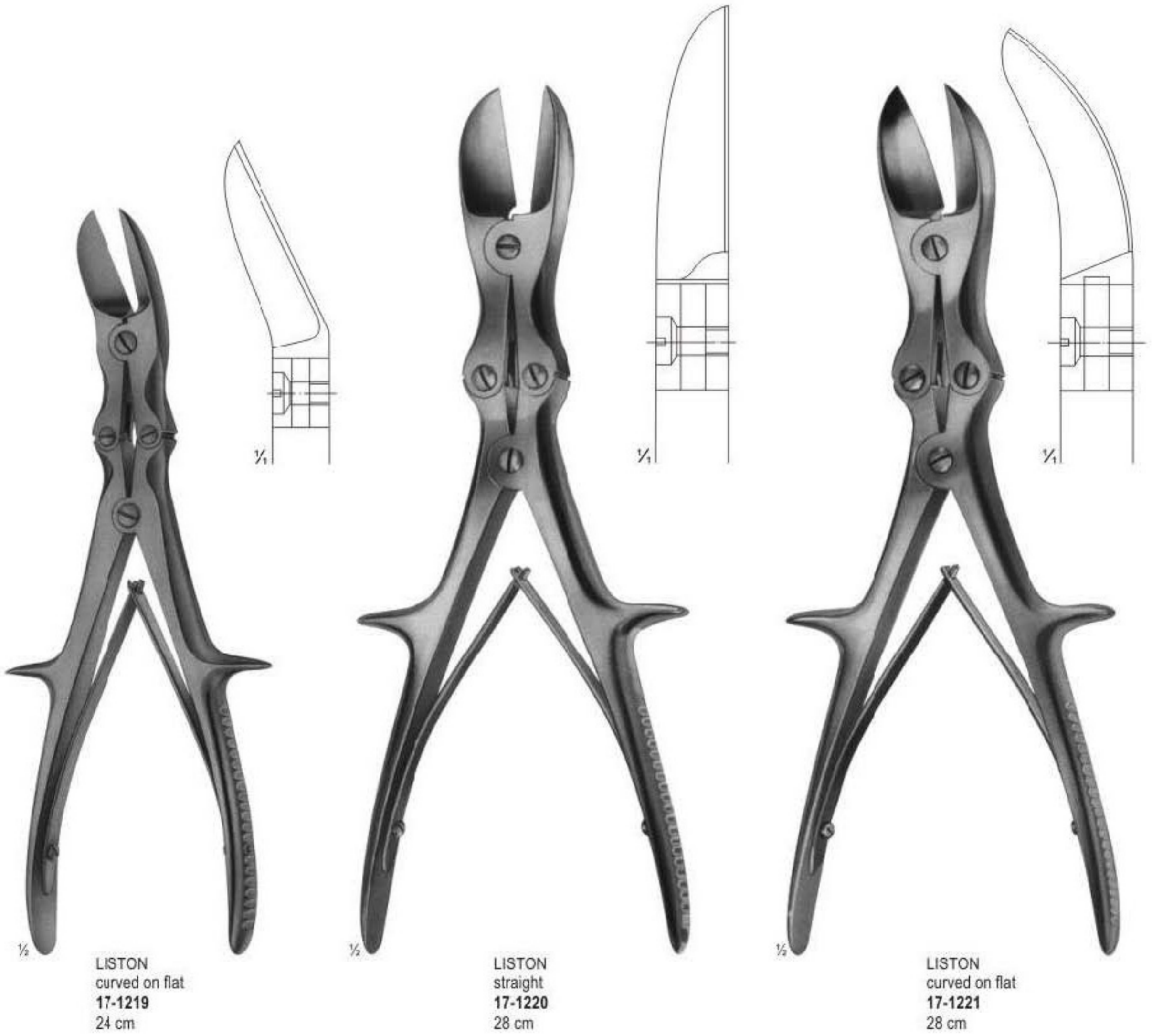

Bone Cutting Forceps



BOHLER
17-1222
14.5 cm



RUSKIN-LISTON
17-1223
19 cm



RUSKIN-LISTON
17-1224
19 cm

Bone Holding Forceps

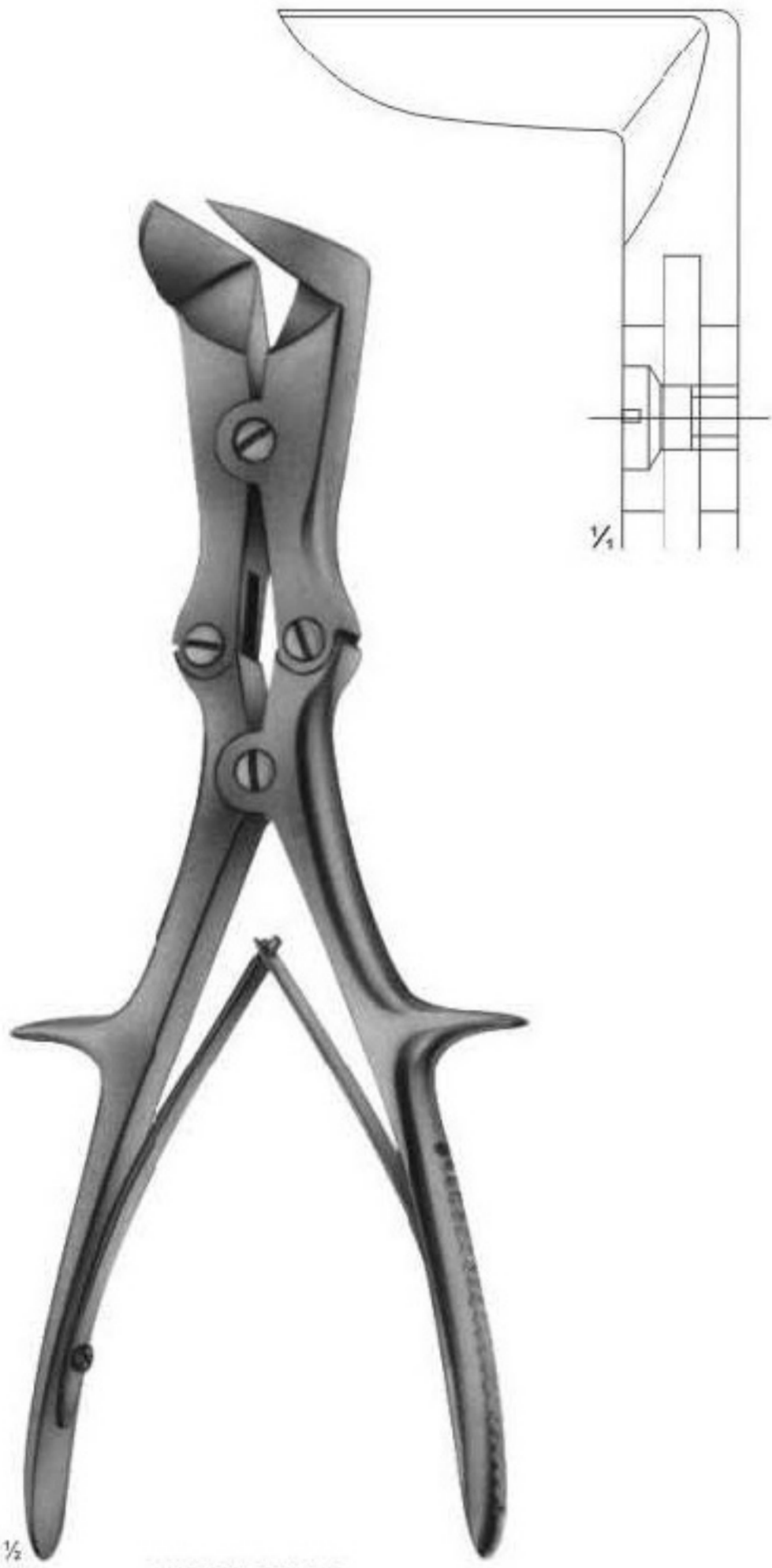

LISTON-STILLE
17-1225
26.5 cm

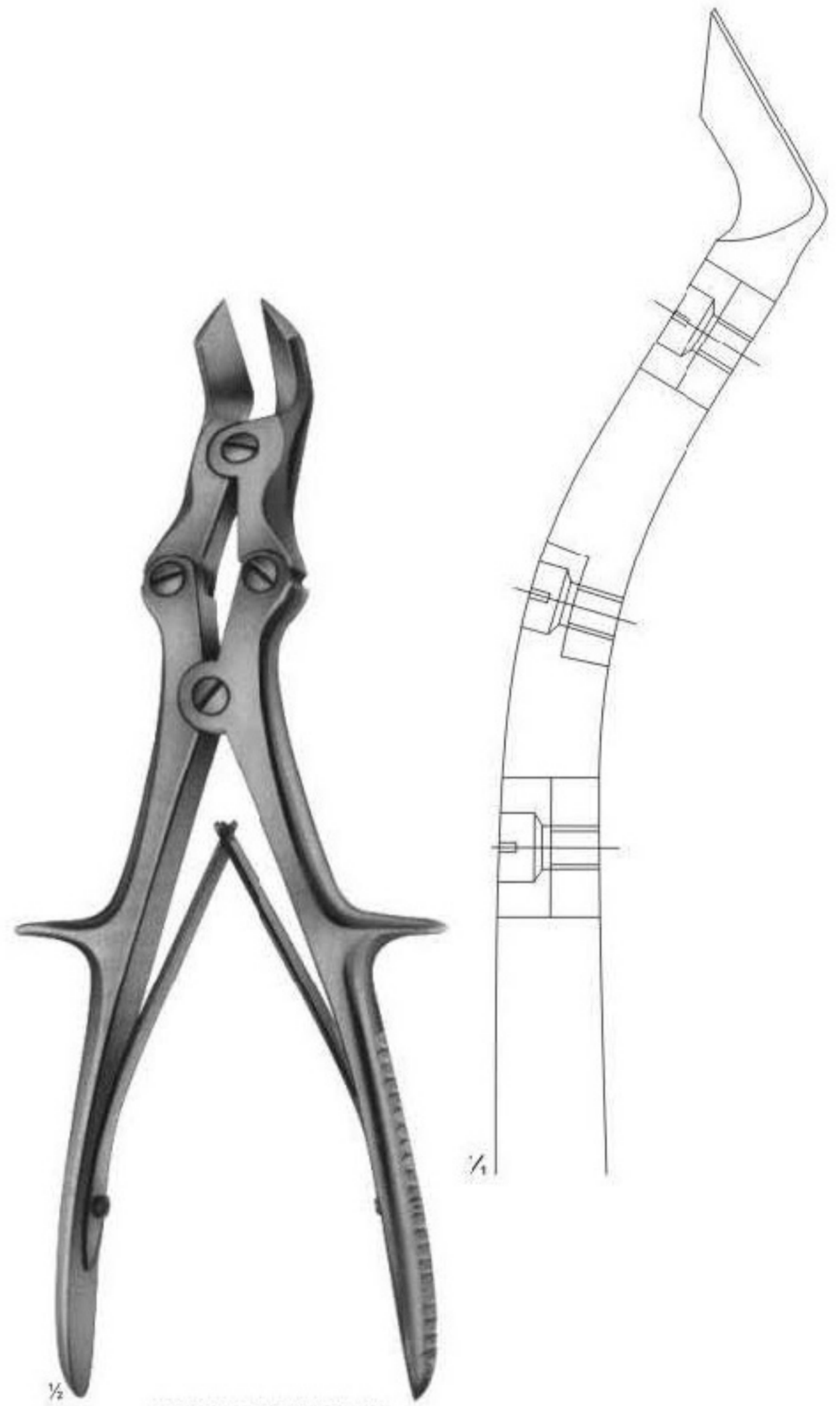

LISTON-KEY-HORSLEY
(TUDOR EDWARDS)
17-1226
25.5 cm

Bone Currettes

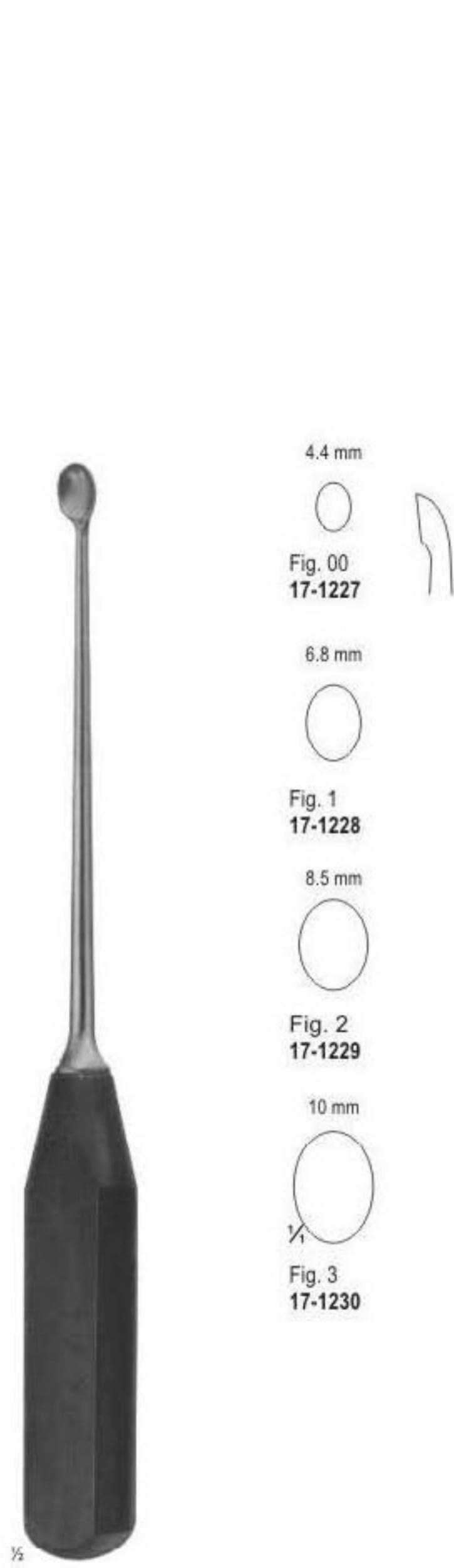

17-1227 - 17-1230
27 cm

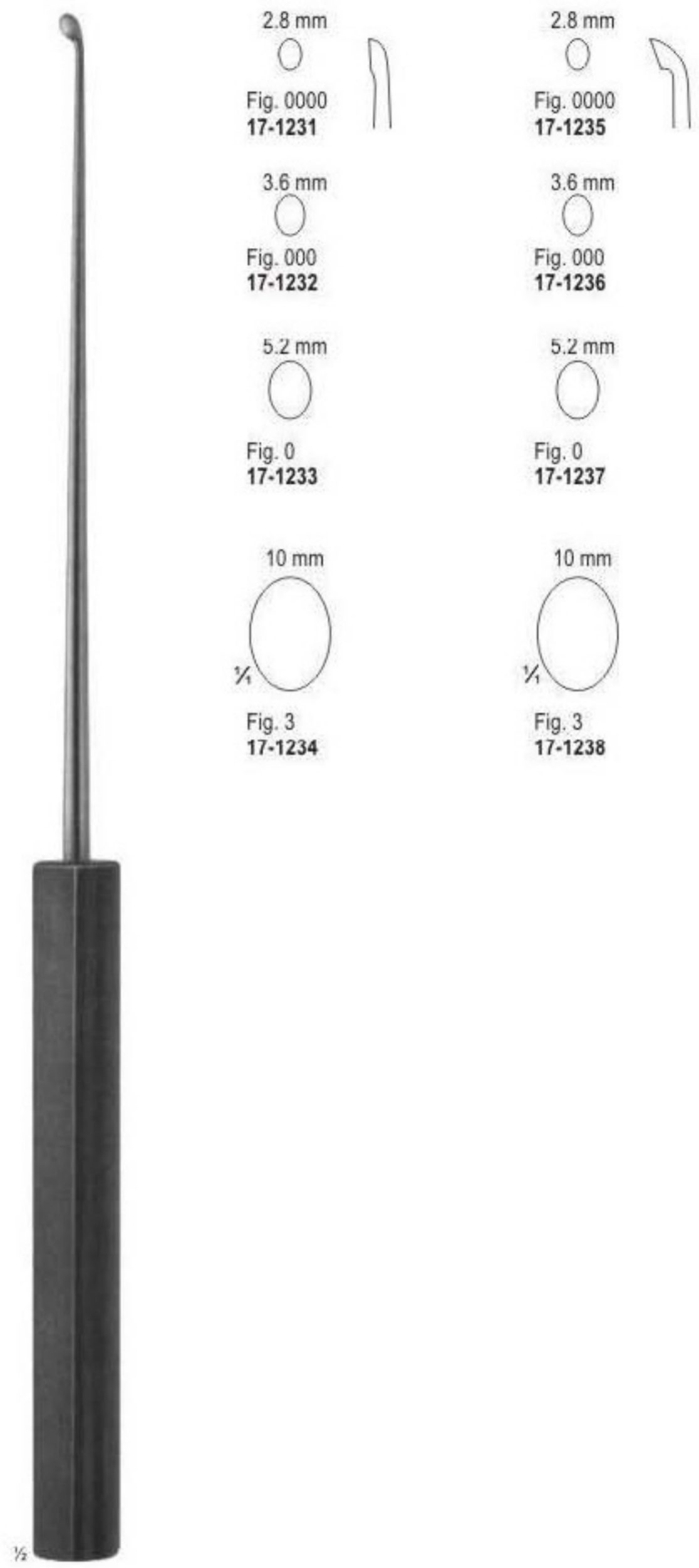

SYPERT
17-1231 - 17-1238
38 cm

Raspatories With HARTPRESS-handle

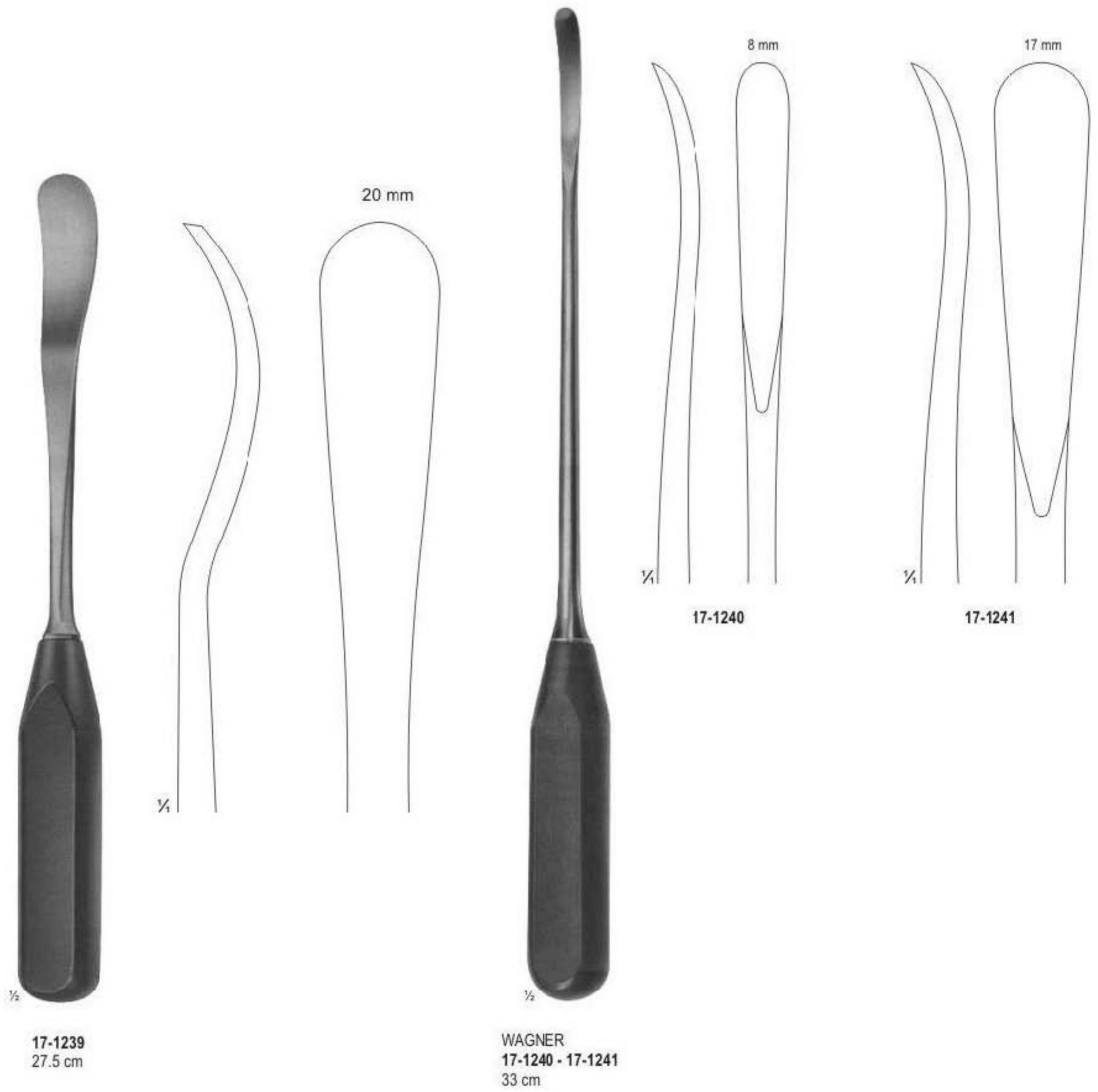

Osteotomes, chisels And Gouges With HARTPRESS -handle

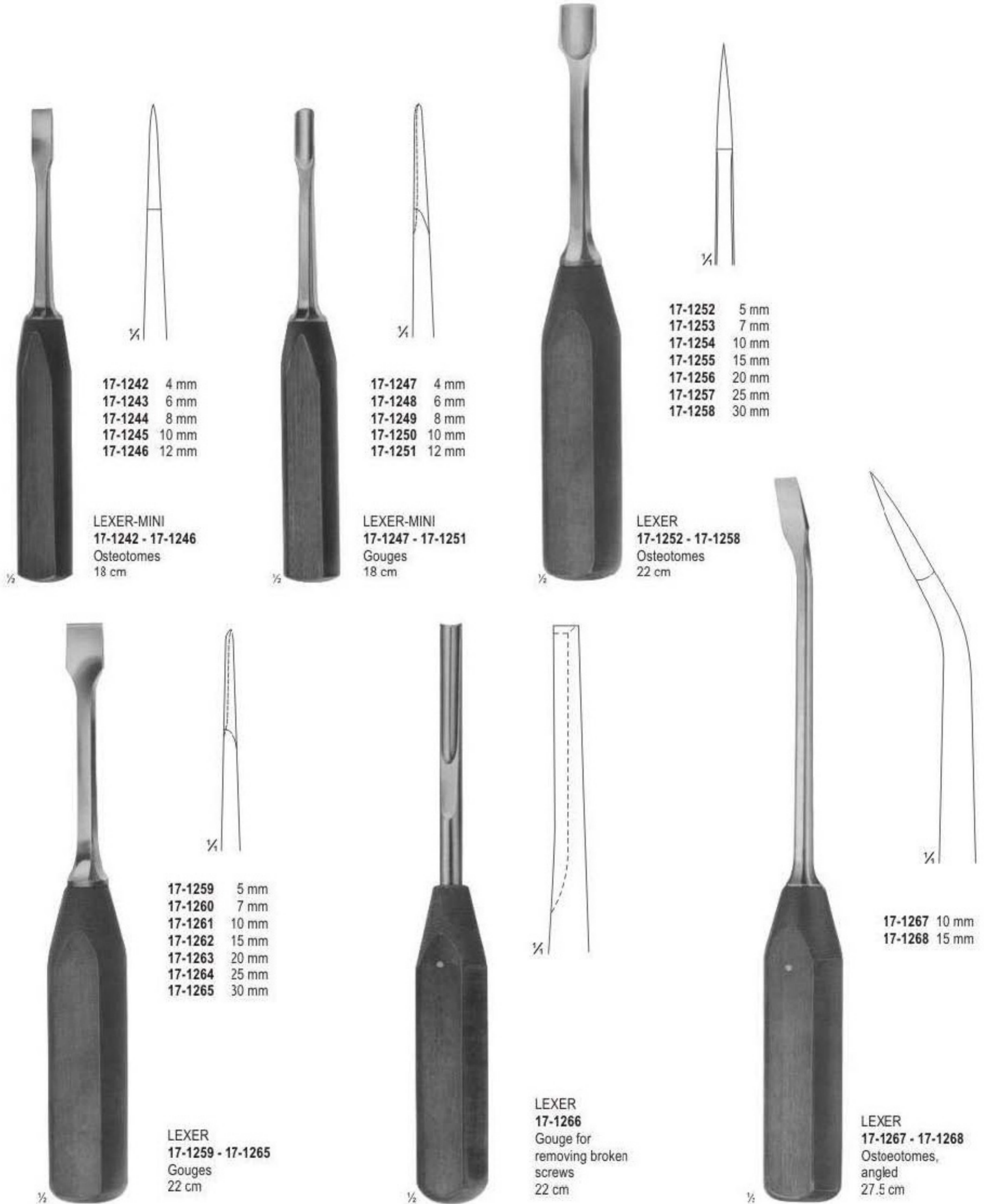

17-1242 4 mm
17-1243 6 mm
17-1244 8 mm
17-1245 10 mm
17-1246 12 mm

LEXER-MINI
17-1242 - 17-1246
Osteotomes
18 cm

17-1247 4 mm
17-1248 6 mm
17-1249 8 mm
17-1250 10 mm
17-1251 12 mm

LEXER-MINI
17-1247 - 17-1251
Gouges
18 cm

17-1252 5 mm
17-1253 7 mm
17-1254 10 mm
17-1255 15 mm
17-1256 20 mm
17-1257 25 mm
17-1258 30 mm

LEXER
17-1252 - 17-1258
Osteotomes
22 cm

17-1259 5 mm
17-1260 7 mm
17-1261 10 mm
17-1262 15 mm
17-1263 20 mm
17-1264 25 mm
17-1265 30 mm

LEXER
17-1259 - 17-1265
Gouges
22 cm

LEXER
17-1266
Gouge for
removing broken
screws
22 cm

17-1267 10 mm
17-1268 15 mm

LEXER
17-1267 - 17-1268
Osteotomes,
angled
27.5 cm

Osteotomes, chisels And Gouges With HARTPRESS -handle



17-1269 10 mm
17-1270 15 mm

1/2
20 mm

1/2
16 mm

1/2
17-1273 5.5 mm
17-1274 9 mm

LEXER
17-1269 - 17-1270
Gouges,
angled
27.5 cm

Chisel
17-1271
24.5 cm

Chisel
curved
17-1272
26.5 cm

ZIELKE
17-1273 - 17-1274
Gouge for
scoliose-operations
23 cm

Osteotomes, chisels And Gouges With HARTPRESS -handle



LANGENBECK
17-1275 - 17-1276

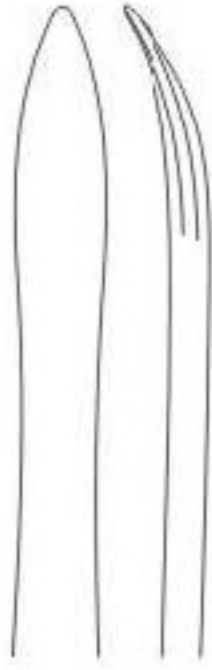

17-1275
20 cm



17-1276
20 cm



COBB
17-1278 - 17-1280



17-1278
28 cm



17-1279
28 cm



17-1280
28 cm



QUERVAIN
17-1277
20 cm

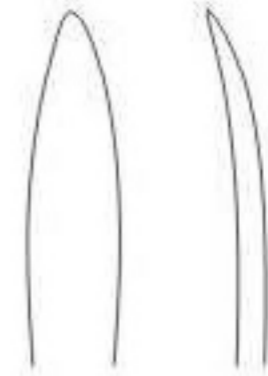

17-1281 - 17-1286
17-1281 17 cm
17-1282 17 cm
17-1283 17 cm
17-1284 17 cm
17-1285 19 cm
17-1286 19 cm

Tampers - Osteotomes, Chisels And Gouges

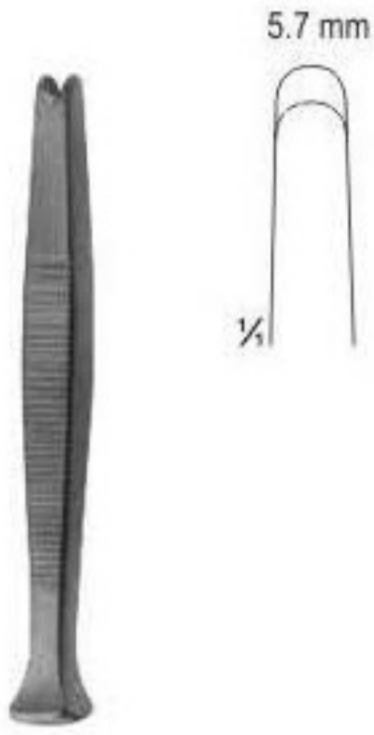

Haase
17-1287
10 cm



PASSOW
17-1288 - 17-1289
12 cm

1/4 □
17-1288
5.7 mm
1/4 □
17-1289
3.5 mm

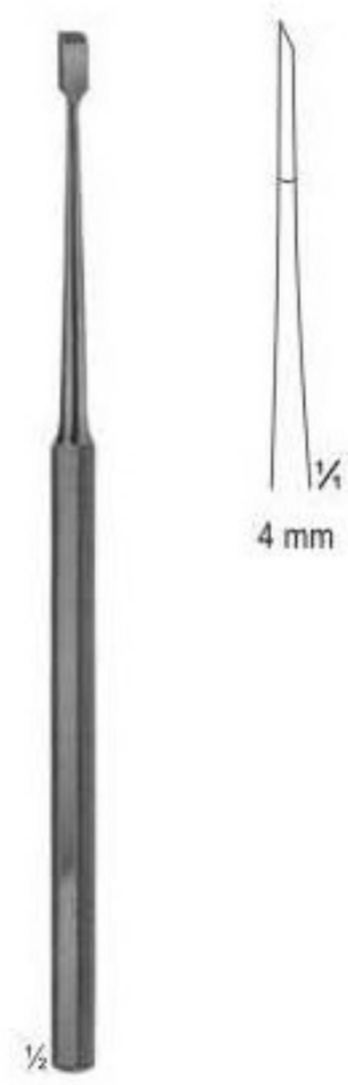

FREER
Chisel
17-1290
16 cm

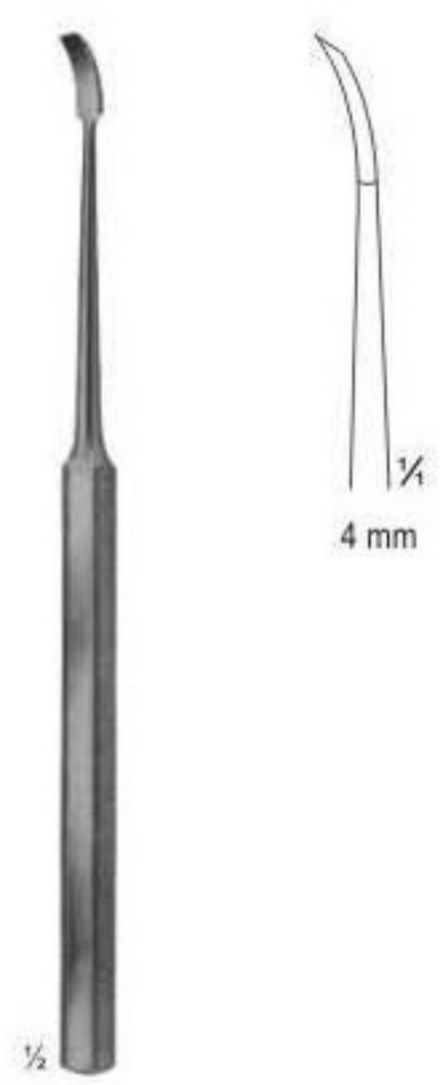

FREER
Chisel, curved
17-1291
16 cm

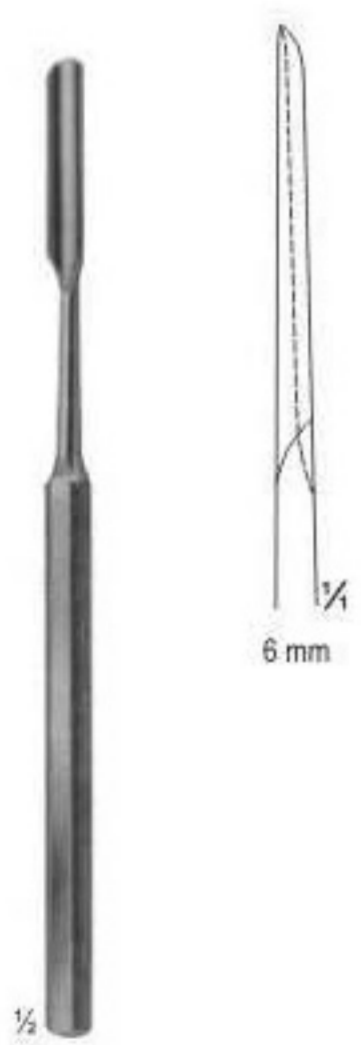

FREER
Gouge
17-1292
15 cm

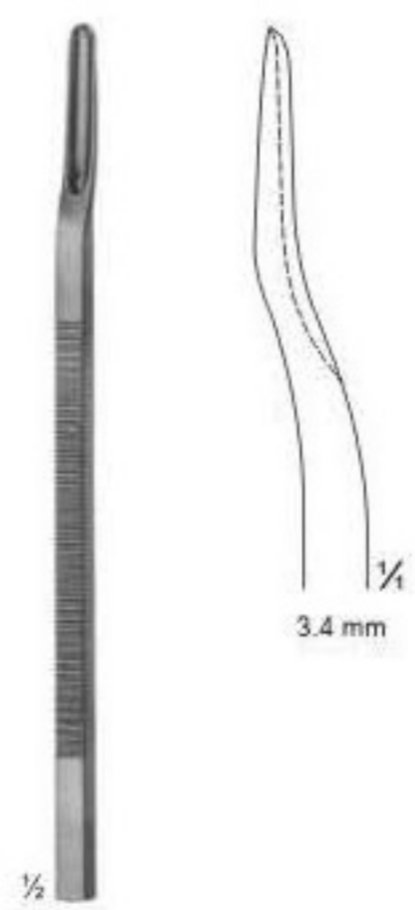

Scaphoid gouge,
downwards curved
17-1293
13.5 cm

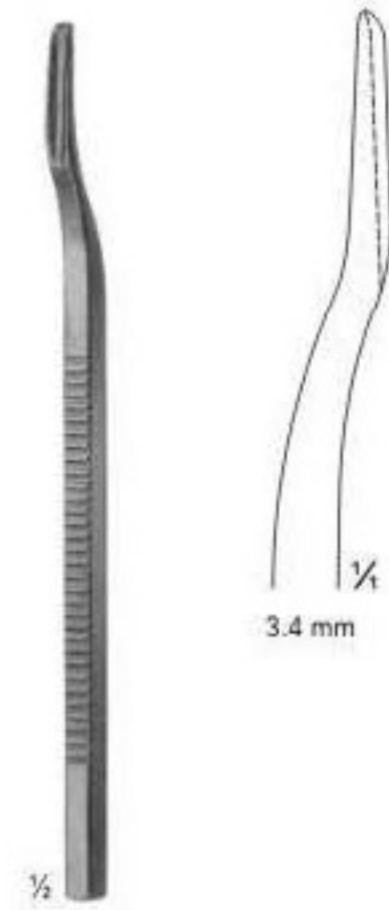

Scaphoid gouge,
upwards curved
17-1294
13.5 cm



Mannerfelt
17-1295 - 17-1297
17-1295 4 mm
17-1296 6 mm
17-1297 8 mm
15.5 cm

Osteotomes Chisels And Gouges



ALEXANDER
17-1298 - 17-1301
Gouges
17 cm

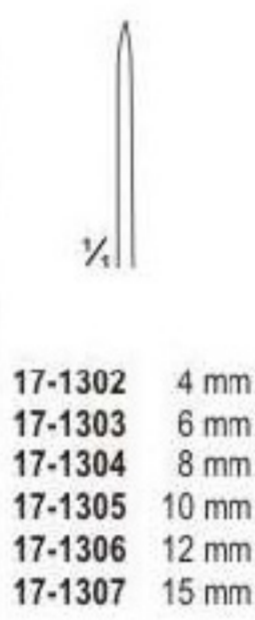

LAMBOTTE
17-1302 - 17-1307
Osteotome
12.5 cm

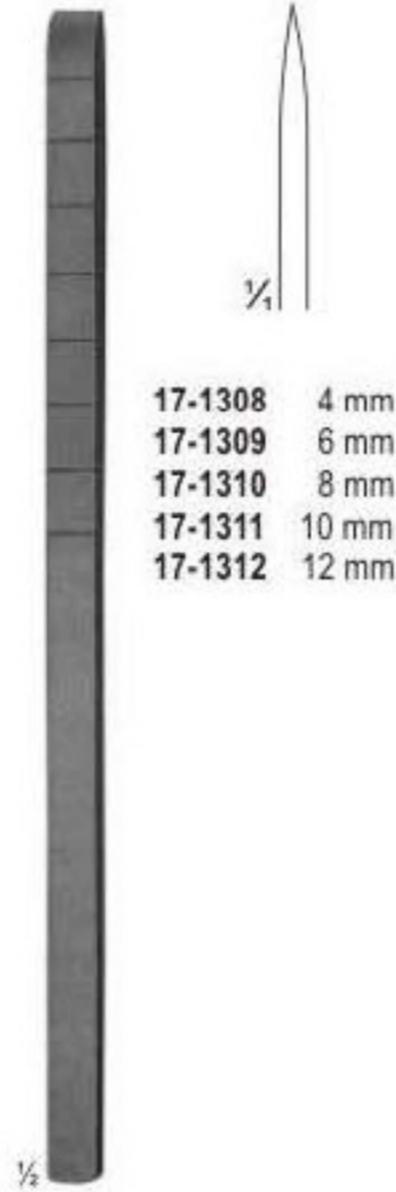

COTTLE
17-1308 - 17-1312
Osteotome with depth
markings
18 cm

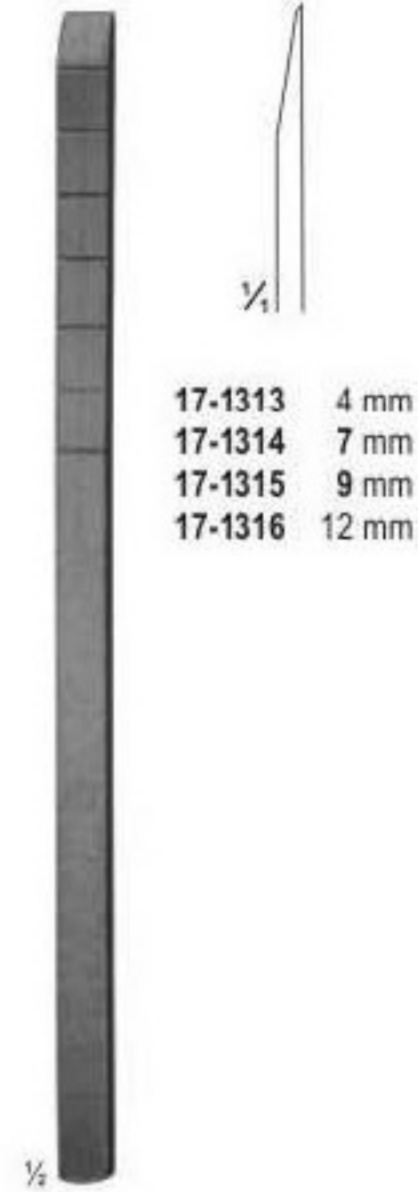

COTTLE
17-1313 - 17-1316
Chisel-Osteotomes
with depth markings
18 cm



COTTLE
17-1317
Fishtail Chisel,
with protected ends
18 cm



STILLE
17-1318 - 17-1322
Chisels
20.5 cm

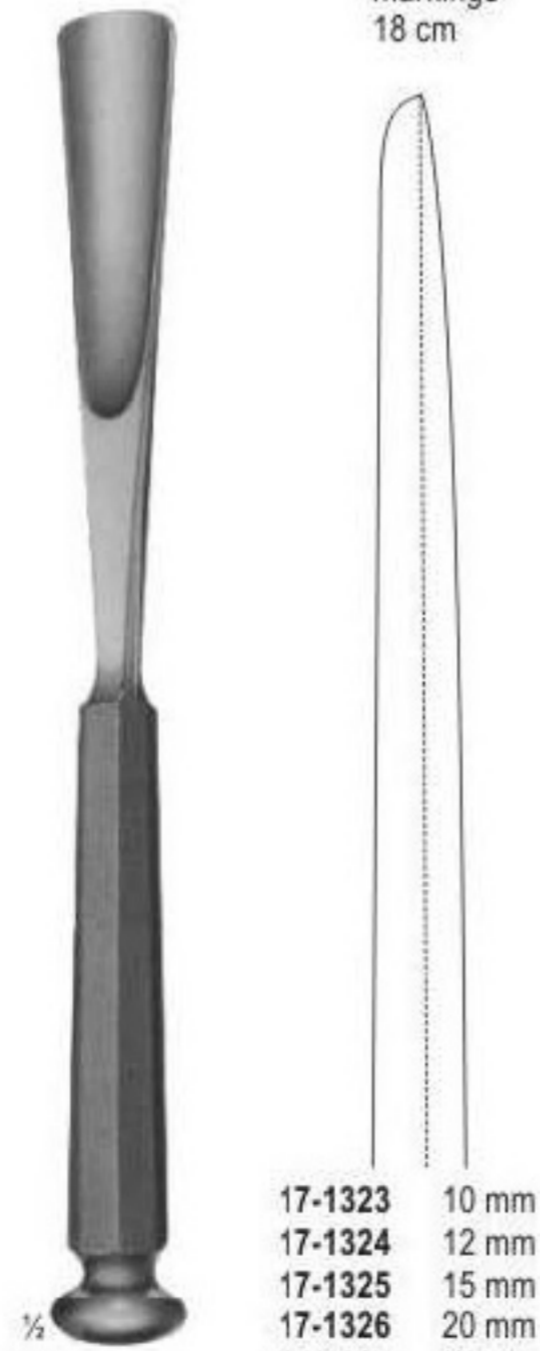

STILLE
17-1323 - 17-1327
Gouges
20.5 cm

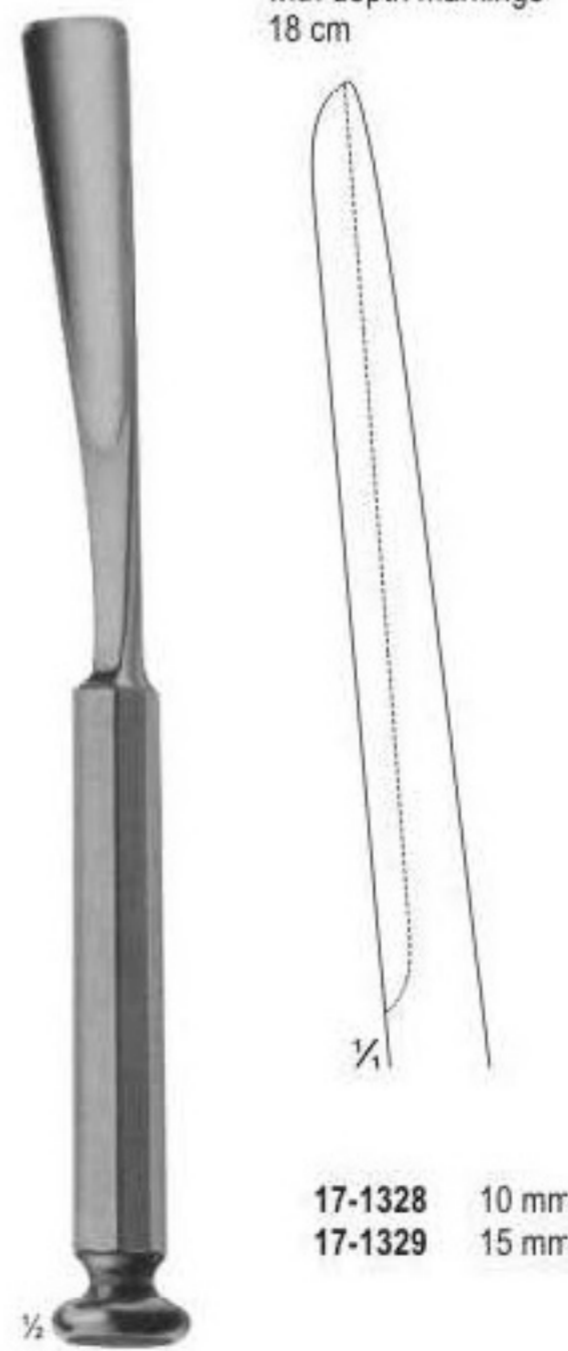

WALTER
17-1328 - 17-1329
Osteotomes
gouges for taking
grafts from the rib
20.5 cm



STILLE
17-1330 - 17-1334
Osteotomes
20.5 cm

Osteotomes Chisels And Gouges



MANNERFELT
17-1335
15.5 cm

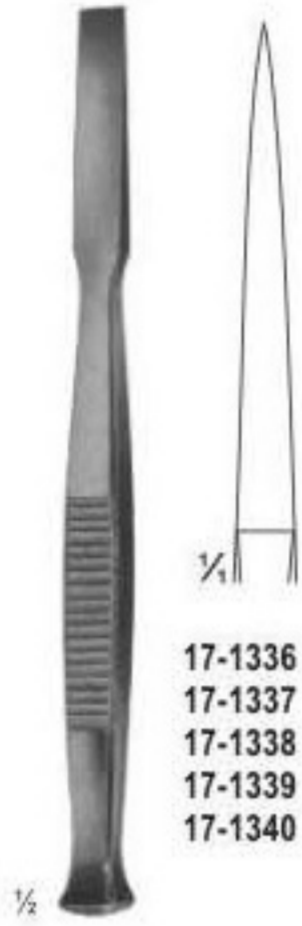

OSTEOTOME
17-1336 - 17-1340
14 cm

- 17-1336** 4 mm
- 17-1337** 6 mm
- 17-1338** 8 mm
- 17-1339** 10 mm
- 17-1340** 12 mm

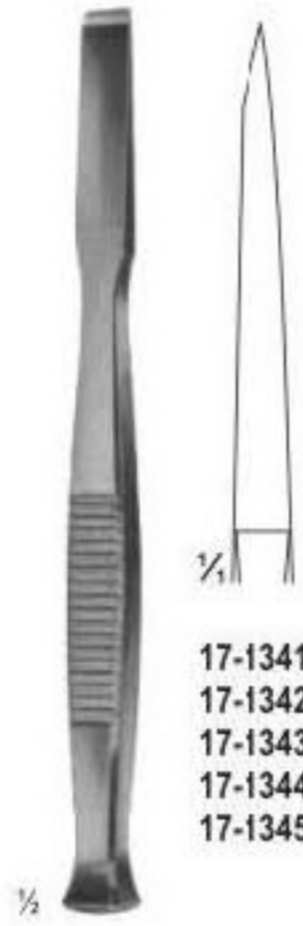

CHISELS
17-1341 - 17-1345
14 cm

- 17-1341** 4 mm
- 17-1342** 6 mm
- 17-1343** 8 mm
- 17-1344** 10 mm
- 17-1345** 12 mm

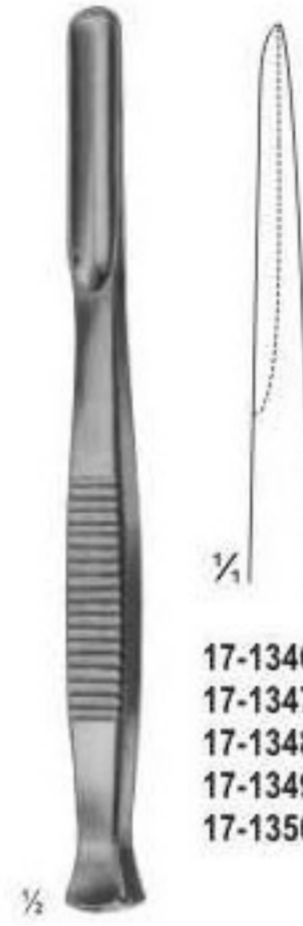

GOUGES
17-1346 - 17-1350
14 cm

- 17-1346** 4 mm
- 17-1347** 6 mm
- 17-1348** 8 mm
- 17-1349** 10 mm
- 17-1350** 12 mm



PARTSCH
17-1351 - 17-1354
Chisels
14 cm

- 17-1351** 3 mm
- 17-1352** 4 mm
- 17-1353** 5 mm
- 17-1354** 6 mm

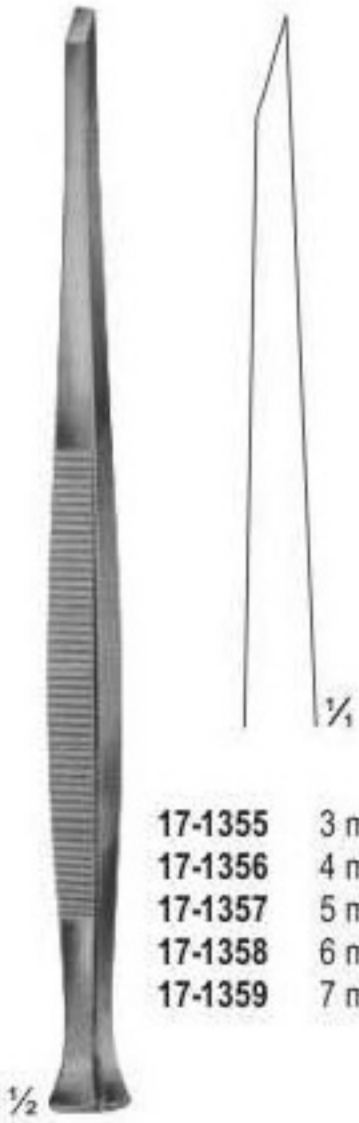

PARTSCH
17-1355 - 17-1359
Chisels
17 cm

- 17-1355** 3 mm
- 17-1356** 4 mm
- 17-1357** 5 mm
- 17-1358** 6 mm
- 17-1359** 7 mm

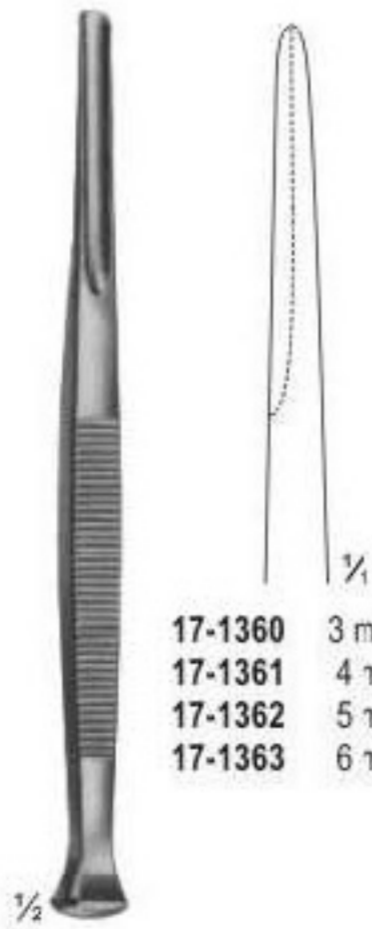

PARTSCH
17-1360 - 17-1363
Gouges
14 cm

- 17-1360** 3 mm
- 17-1361** 4 mm
- 17-1362** 5 mm
- 17-1363** 6 mm

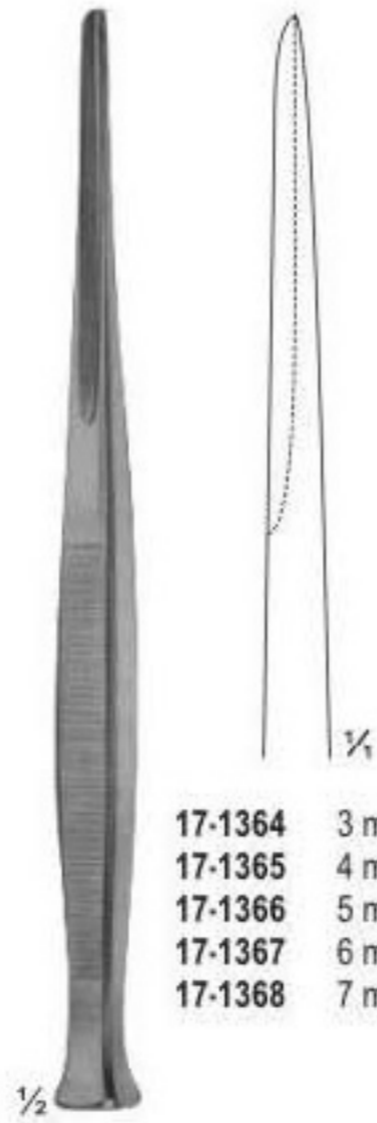

PARTSCH
17-1364 - 17-1368
Gouges
17 cm

- 17-1364** 3 mm
- 17-1365** 4 mm
- 17-1366** 5 mm
- 17-1367** 6 mm
- 17-1368** 7 mm

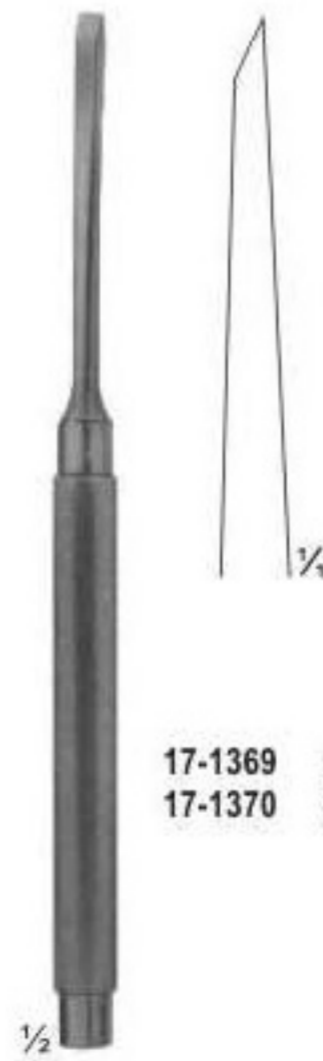

LUCAS
17-1369 - 17-1370
Chisels
16 cm

- 17-1369** 4 mm
- 17-1370** 6 mm

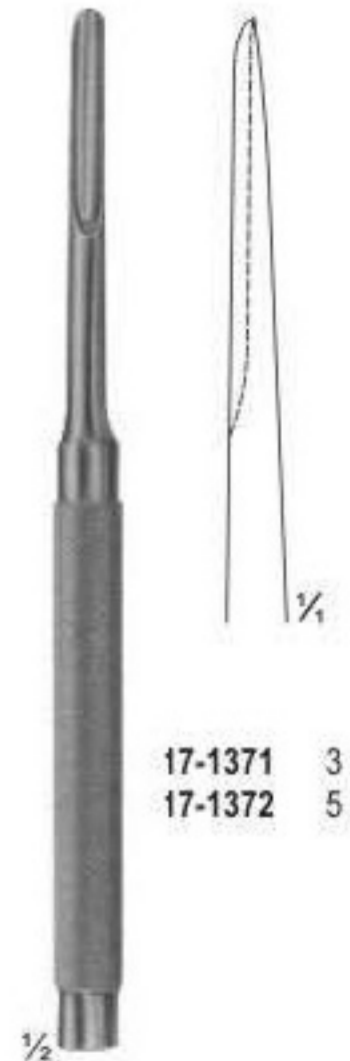

LUCAS
17-1371 - 17-1372
Gouges
16 cm

- 17-1371** 3 mm
- 17-1372** 5 mm

Osteotomes, Gouges

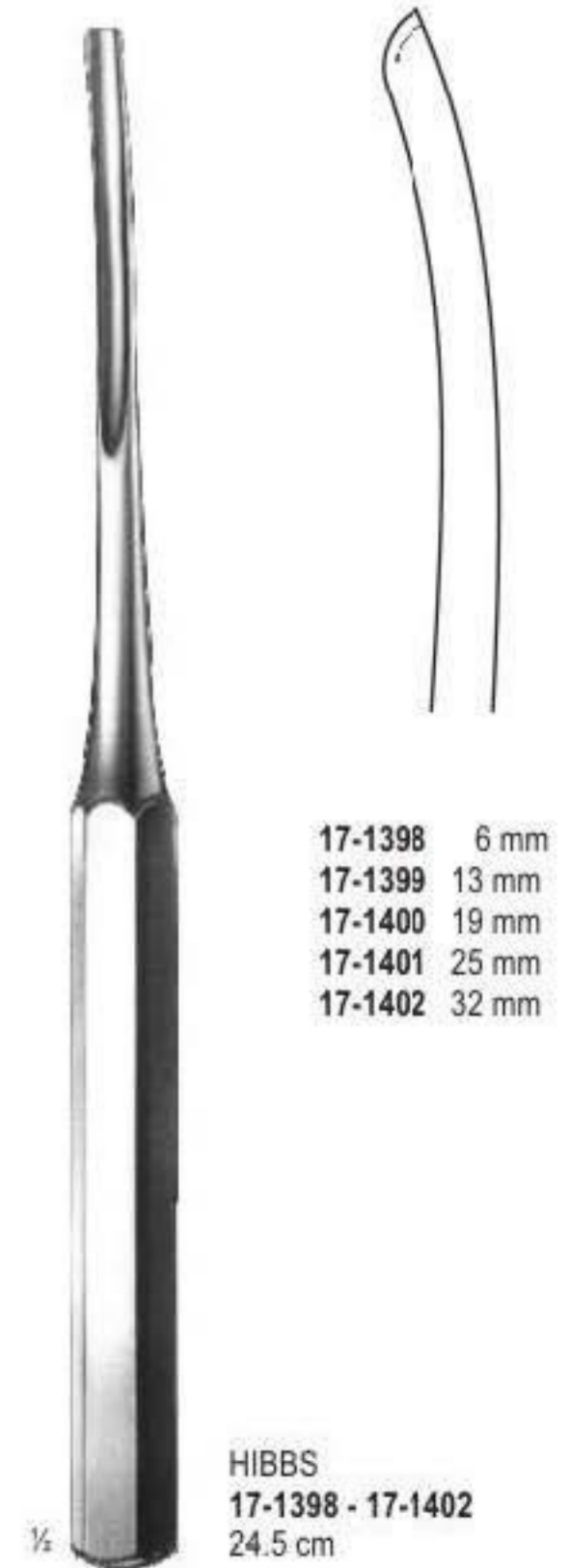
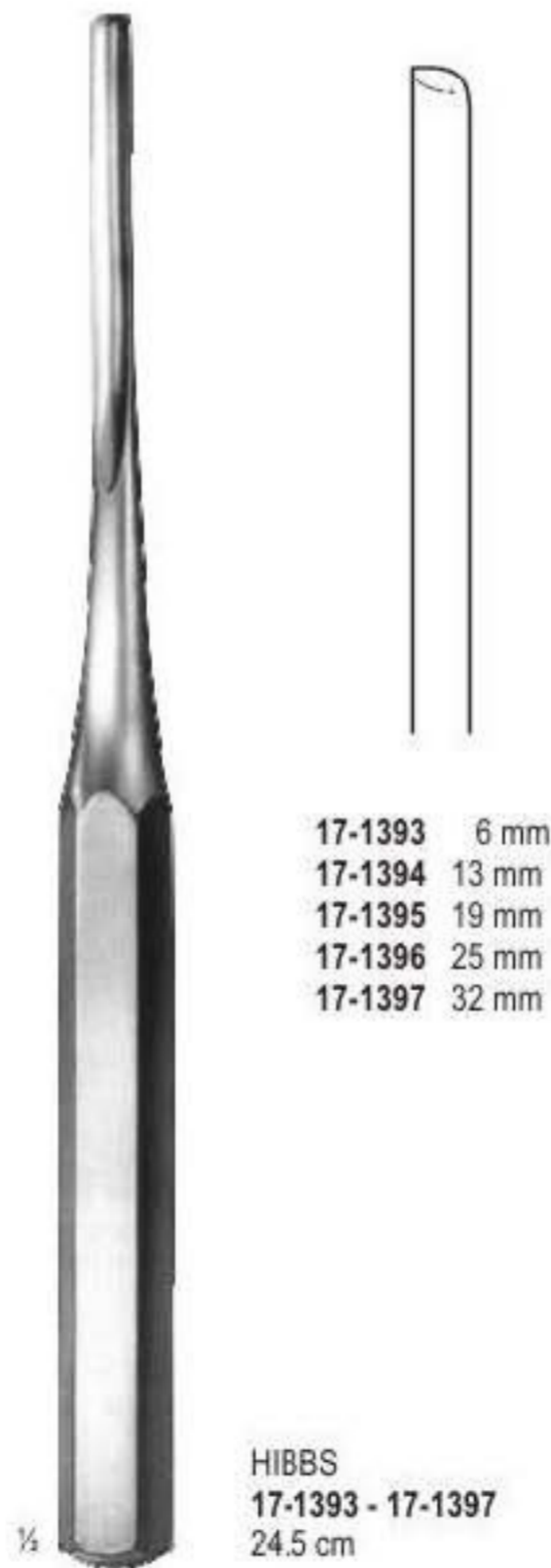
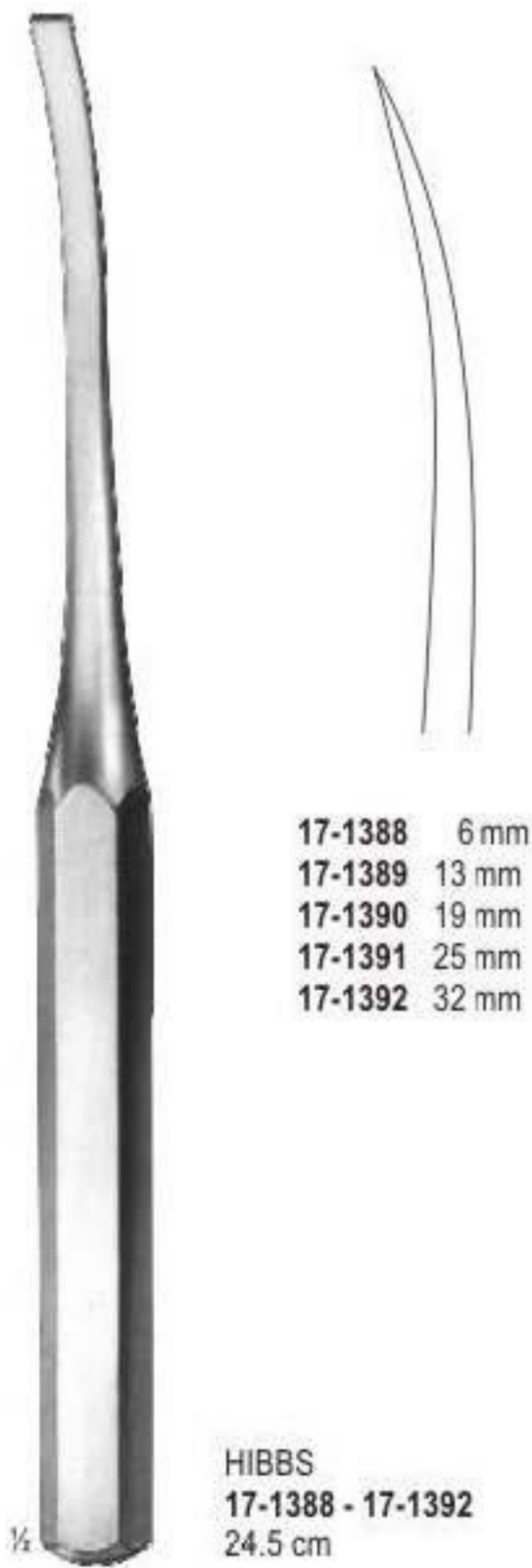
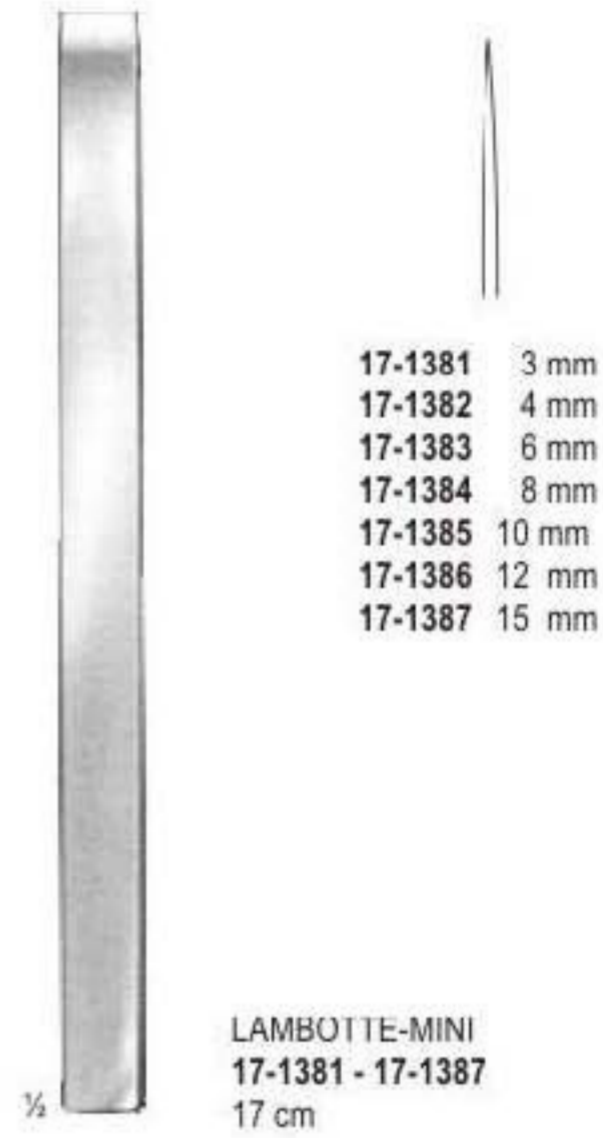
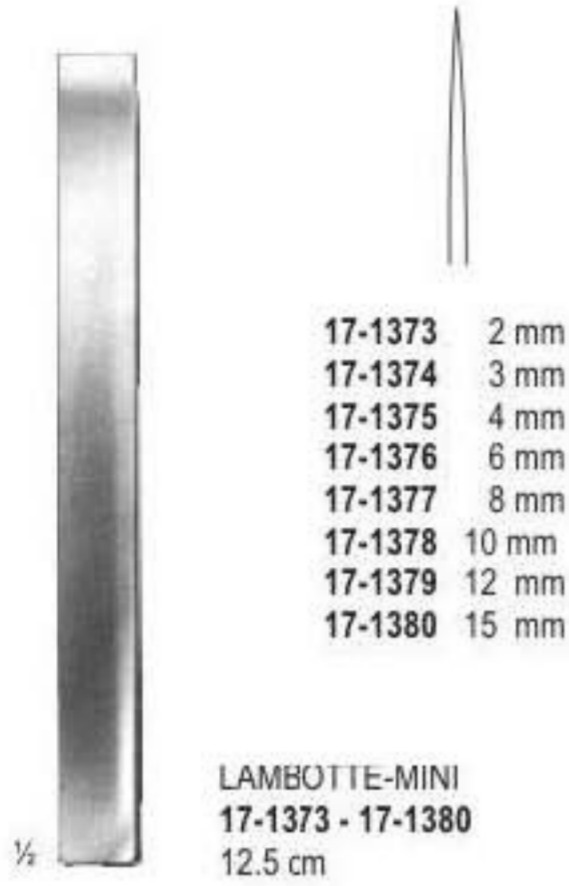

Osteotomes



- 17-1403
6 mm
- 17-1404
9 mm
- 17-1405
13 mm
- 17-1406
16 mm
- 17-1407
19 mm
- 17-1408
25 mm
- 17-1409
32 mm

1/2

SMITH-PETERSEN
17-1403 - 17-1409
20.5 cm



- 17-1410
6 mm
- 17-1411
9 mm
- 17-1412
13 mm
- 17-1413
16 mm
- 17-1414
19 mm
- 17-1415
25 mm
- 17-1416
32 mm

1/2

SMITH-PETERSEN
17-1410 - 17-1416
20.5 cm



- 17-1417
9 mm
- 17-1418
14 mm
- 17-1419
19 mm
- 17-1420
25 mm

1/2

SMITH-PETERSEN
17-1417 - 17-1420
20.5 cm



- 17-1421
9 mm
- 17-1422
14 mm
- 17-1423
19 mm
- 17-1424
25 mm

1/2

SMITH-PETERSEN
17-1421 - 17-1424
20.5 cm



Osteotomes

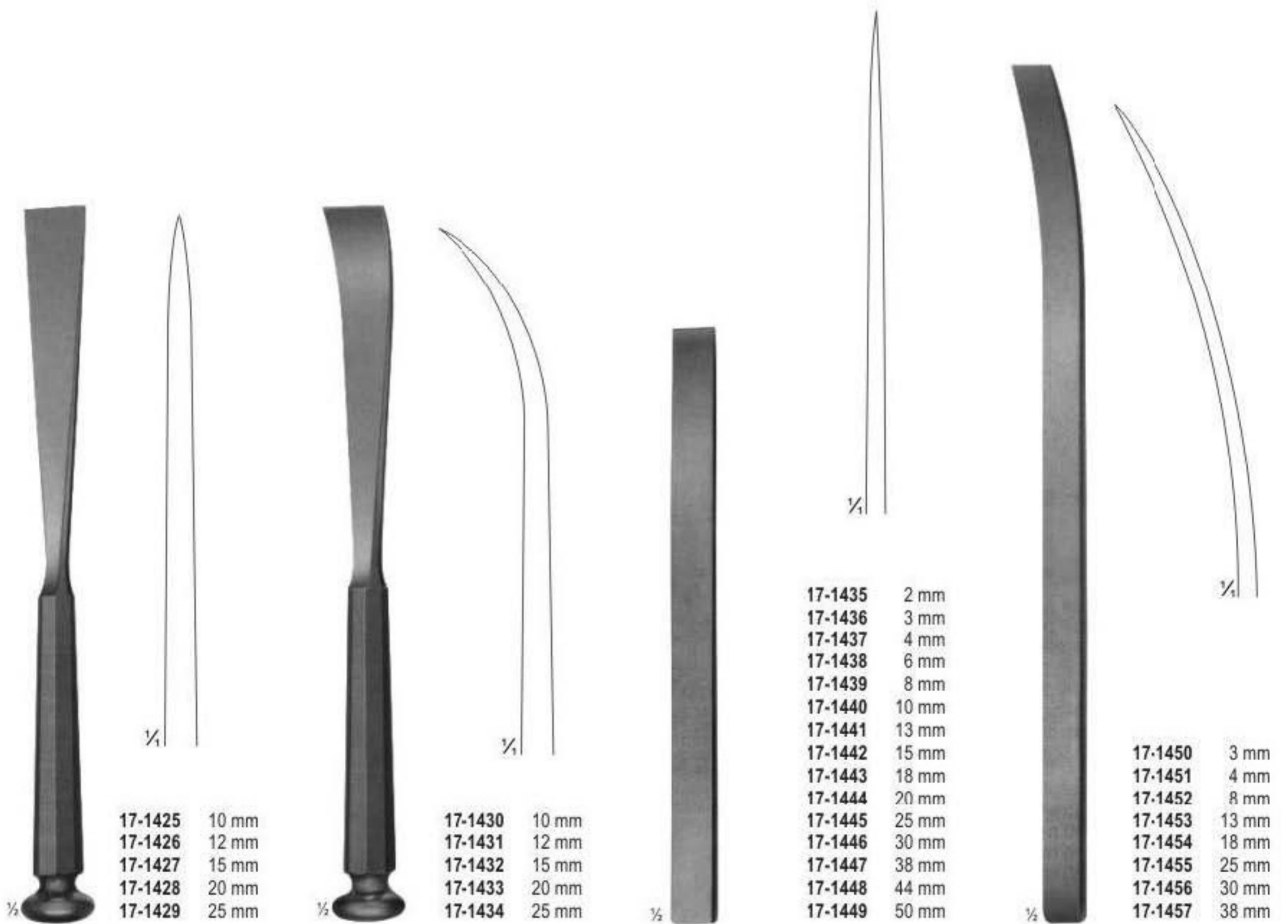

STILLE
17-1425 - 17-1429
Osteotomes
20.5 cm

STILLE
17-1430 - 17-1434
Osteotomes, curved
20.5 cm

LAMBOTTE
Osteotomes
17-1435 - 17-1449
17 cm

LAMBOTTE
17-1450 - 17-1457
Osteotomes, curved
24.5 cm

Osteotomes, Chisels



- 17-1458**
3 mm
- 17-1459**
5 mm
- 17-1460**
6 mm
- 17-1461**
8 mm
- 17-1462**
9 mm

HOKE
17-1458 - 17-1462
17 cm



- 17-1463**
6 mm
- 17-1464**
13 mm
- 17-1465**
19 mm
- 17-1466**
25 mm
- 17-1467**
32 mm

HIBBS
17-1463 - 17-1467
24.5 cm



- 17-1468**
6 mm
- 17-1469**
13 mm
- 17-1470**
19 mm
- 17-1471**
25 mm
- 17-1472**
32 mm

HIBBS
17-1468 - 17-1472
24.5 cm



Bone Curettes



BRUNS
17-1473 - 17-1479
16.5 cm

- Fig. 000
17-1473
3 mm
- Fig. 00
17-1474
4 mm
- Fig. 0
17-1475
5 mm
- Fig. 1
17-1476
6 mm
- Fig. 2
17-1477
8 mm
- Fig. 3
17-1478
10 mm
- Fig. 4
17-1479
12 mm



SCHEDE
17-1480 - 17-1486
17 cm

- Fig. 000
17-1480
2.5 mm
- Fig. 00
17-1481
3.4 mm
- Fig. 0
17-1482
4.2 mm
- Fig. 1
17-1483
5.2 mm
- Fig. 2
17-1484
6.3 mm
- Fig. 3
17-1485
7.4 mm
- Fig. 4
17-1486
8 mm



VOLKMANN
17-1487 - 17-1496
17 cm

- Fig.0000
17-1487
2.8 mm
- Fig.000
17-1488
3.6 mm
- Fig.00
17-1489
4.4 mm
- Fig.0
17-1490
5.2 mm
- Fig.1
17-1491
6.8 mm
- Fig.2
17-1492
8.5 mm
- Fig.3
17-1493
10 mm
- Fig.4
17-1494
11.5 mm
- Fig.5
17-1495
13 mm
- Fig.6
17-1496
14.5 mm



WILLIGER
17-1497 - 17-1498
17 cm

- Fig.00
17-1497
3.4 mm
- Fig.1
17-1498
5.2 mm

Bone Currettes

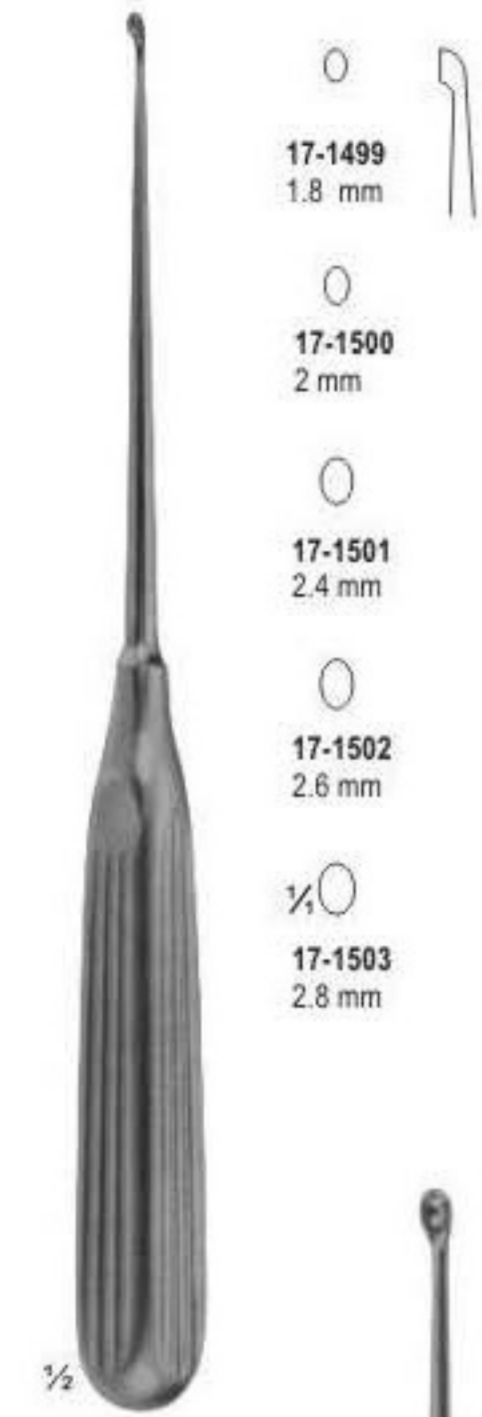

LEMPERT
17-1499 - 17-1503
21.5 cm



HALLE
17-1504 - 17-1506
21.5 cm

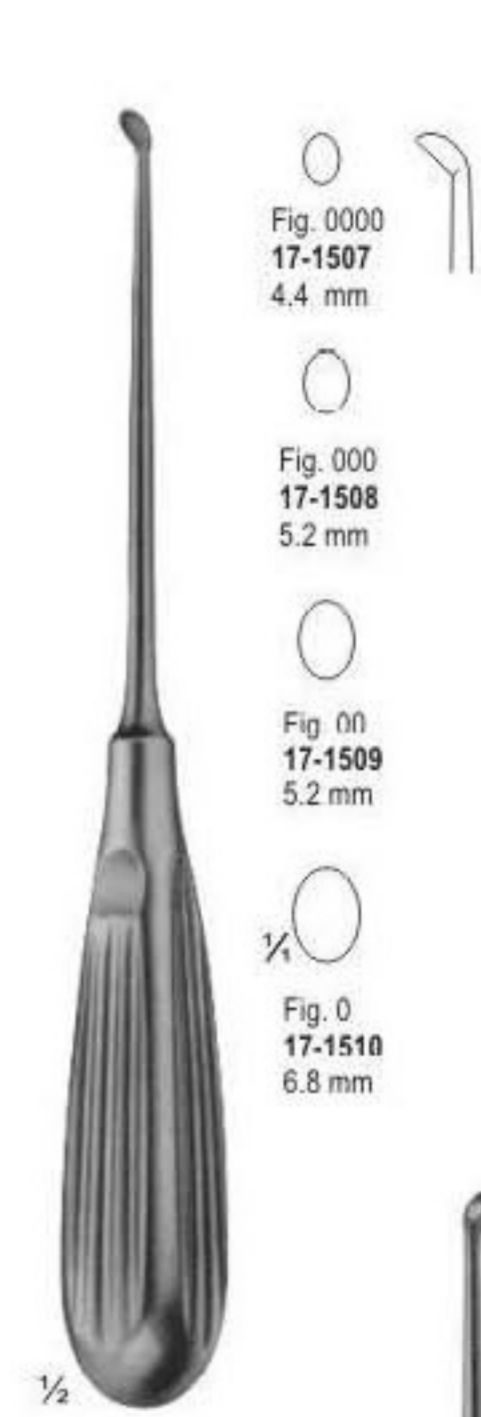

DAUBENSPECK
17-1507 - 17-1510
20 cm



17-1511 - 17-1514
25 cm

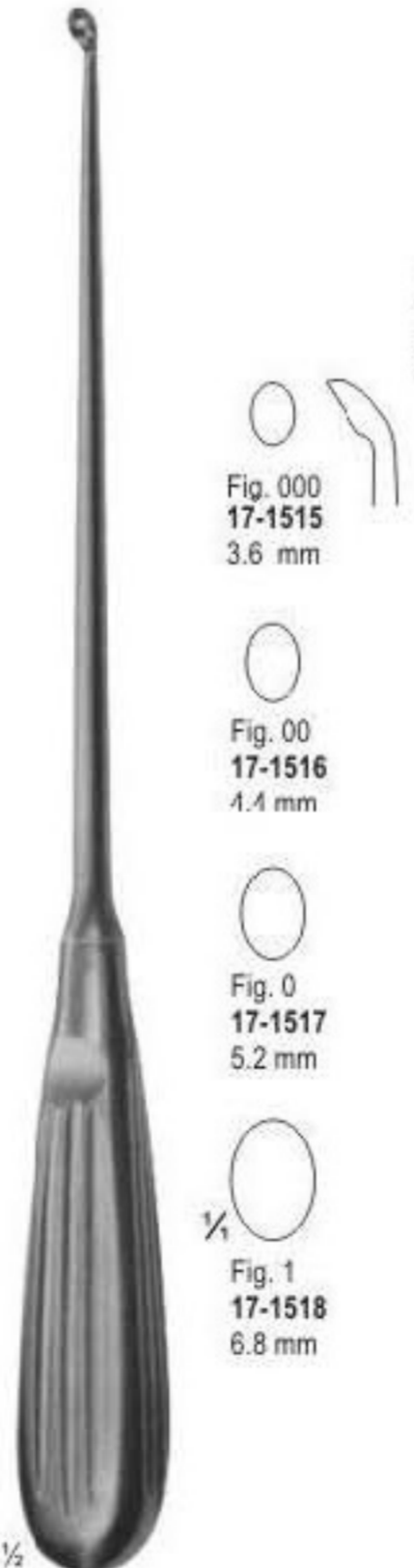

17-1515 - 17-1518
25 cm



BUSHE
17-1519 - 17-1521
25 cm

Bone Currettes

$\frac{1}{4}$ ○

Fig. 1
17-1522

○

Fig. 2
17-1523

○

Fig. 3
17-1524

○

Fig. 4
17-1525

○

Fig. 5
17-1526

○

Fig. 6
17-1527



$\frac{1}{2}$

MODELL USA
Oval, With Hollow Handle
17-1522 - 17-1527
16.5 cm

$\frac{1}{4}$ ○

Fig. 1
17-1528

○

Fig. 2
17-1529

○

Fig. 3
17-1530

○

Fig. 4
17-1531

○

Fig. 5
17-1532

○

Fig. 6
17-1533



$\frac{1}{2}$

MODELL USA
Oval, With Hollow Handle
17-1528 - 17-1533
16.5 cm

$\frac{1}{4}$ ○

Fig. 1
17-1534

○

Fig. 2
17-1535

○

Fig. 3
17-1536

○

Fig. 4
17-1537

○

Fig. 5
17-1538

○

Fig. 6
17-1539



$\frac{1}{2}$

MODELL USA
Oval, With Hollow Handle
17-1534 - 17-1539
16 cm

Bone Currettes



SIMON
17-1540 - 17-1542
23.5 cm

- 

Fig. 000
17-1540
3.6 mm
- 

Fig. 00
17-1541
4.4 mm
- 

Fig. 0
17-1542
5.2 mm



SIMON
17-1543 - 17-1548
24 cm

- 

Fig. 1
17-1543
6.8 mm
- 

Fig. 2
17-1544
8.5 mm
- 

Fig. 3
17-1545
10 mm
- 

Fig. 4
17-1546
11.5 mm
- 

Fig. 5
17-1547
13 mm
- 

Fig. 6
17-1548
14.5 mm

Bone Currettes



Fig. 1
17-1549



Fig. 2
17-1550



Fig. 3
17-1551



Fig. 1
17-1555



Fig. 4
17-1552



Fig. 2
17-1556



Fig. 5
17-1553



Fig. 3
17-1557



Fig. 6
17-1554



1/2

SIMON
Oval, With Hollow Handle
17-1549 - 17-1554
22.5 cm



1/2

MODELL USA
Oval, Malleable Shaft,
With Hollow Handle
17-1555 - 17-1557
21 cm



1/2

17-1558
21 cm



1/4



Bone Currettes, Double-ended



17-1559
12.5 cm



17-1562
13 cm



17-1560
14.5 cm

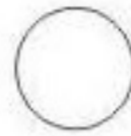

17-1563
16 cm

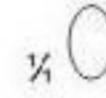

$\frac{1}{4}$
Fig. 00/0
17-1565



Fig. 00/00
17-1568



17-1561
17 cm



17-1564
20 cm



Fig. 0/1
17-1566

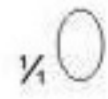
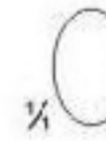

Fig. 0/0
17-1569



Fig. $\frac{1}{2}$
17-1567

Fig. 1/1
17-1570



VOLKMANN
17-1559 - 17-1561



VOLKMANN
17-1562 - 17-1564



WILLIGER
17-1565 - 17-1567
14 cm



WILLIGER
Oval
17-1568 - 17-1570
16.5 cm

Bone Curettes



JACOBSON
17-1571
14 cm

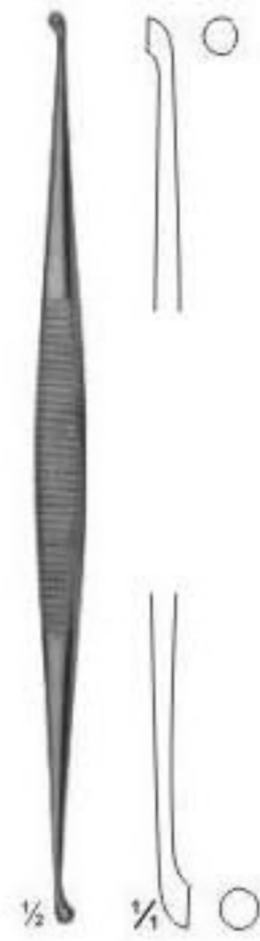

MARTINI
17-1572
14 cm



MARTINI
17-1573
14 cm



WILLIGER
17-1574
14.5 cm



JANSEN
17-1575
16 cm



BARTH
17-1576
18 cm



VOLKMANN
17-1577
13 cm

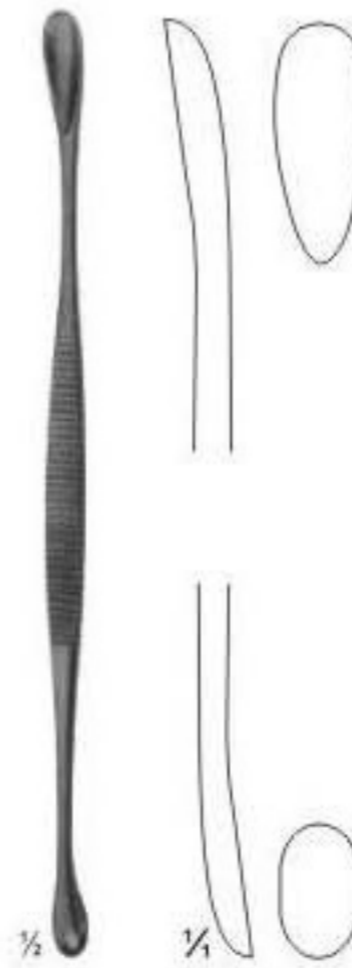

VOLKMANN
17-1578
14.5 cm



VOLKMANN
17-1579
17 cm

Bone Curettes



JACOBSON
17-1571
14 cm

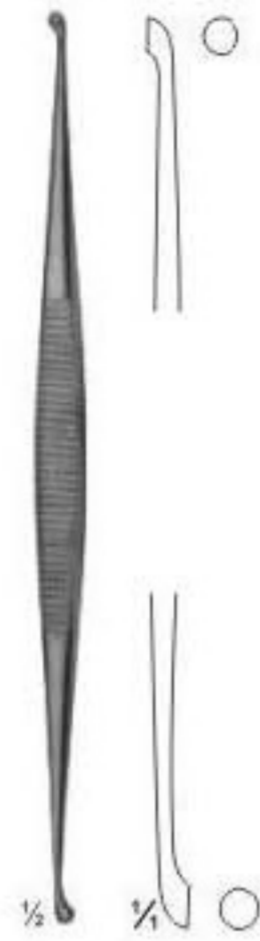

MARTINI
17-1572
14 cm



MARTINI
17-1573
14 cm



WILLIGER
17-1574
14.5 cm



JANSEN
17-1575
16 cm



BARTH
17-1576
18 cm



VOLKMANN
17-1577
13 cm

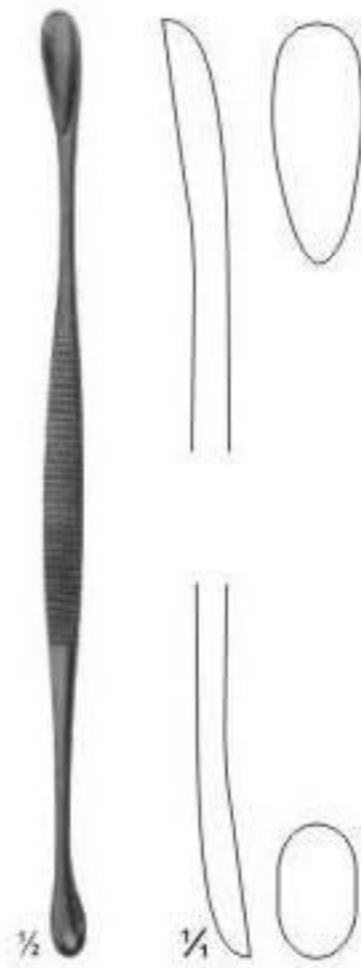

VOLKMANN
17-1578
14.5 cm

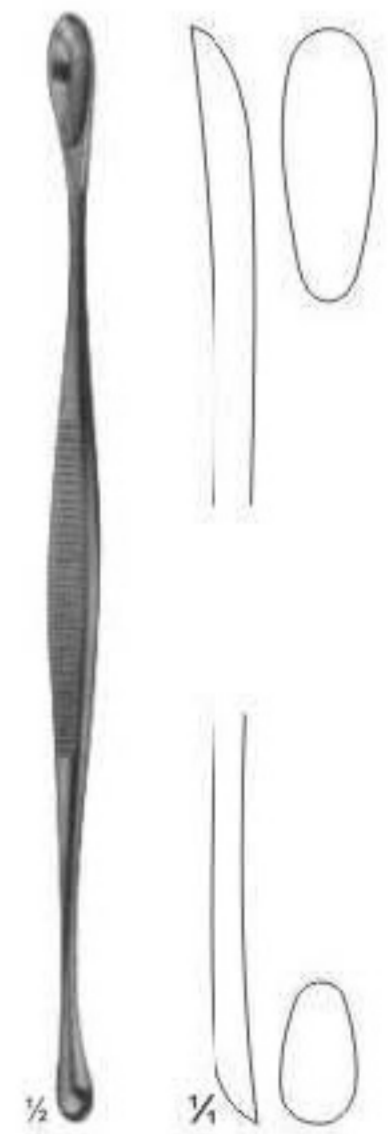

VOLKMANN
17-1579
17 cm

Raspatories

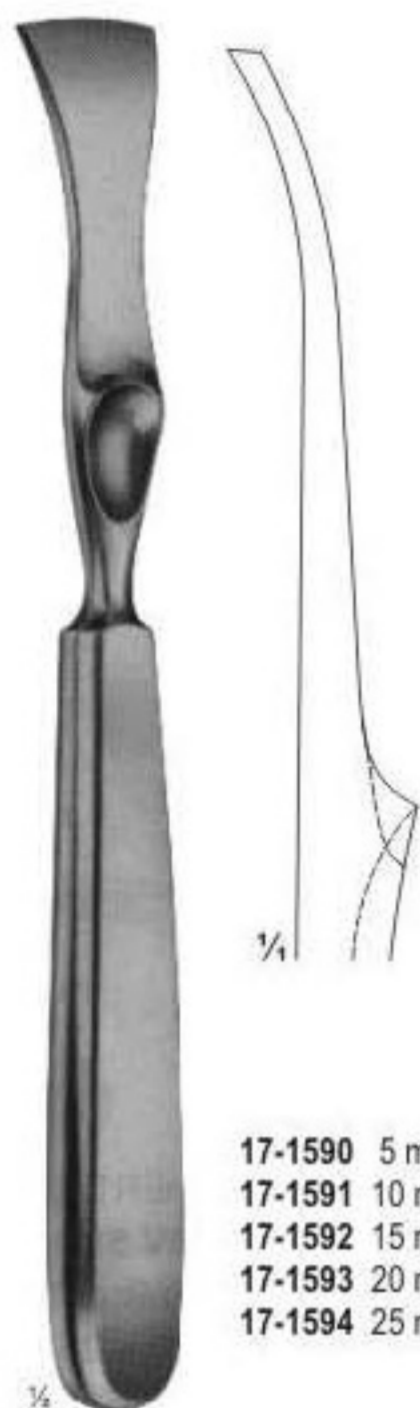

- 17-1590 5 mm
- 17-1591 10 mm
- 17-1592 15 mm
- 17-1593 20 mm
- 17-1594 25 mm

LAMBOTTE
17-1590 - 17-1594
21.5 cm



FARABEUF
17-1595 - 17-1596
17-1595 12.5 cm
17-1596 20 cm

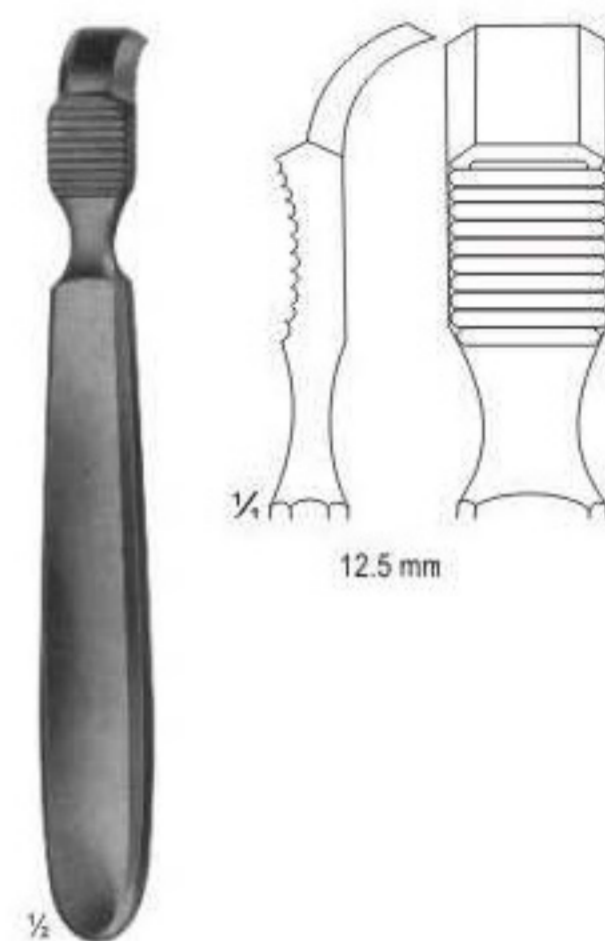

FARABEUF
17-1597 - 17-1598
17-1597 12.5 cm
17-1598 20 cm

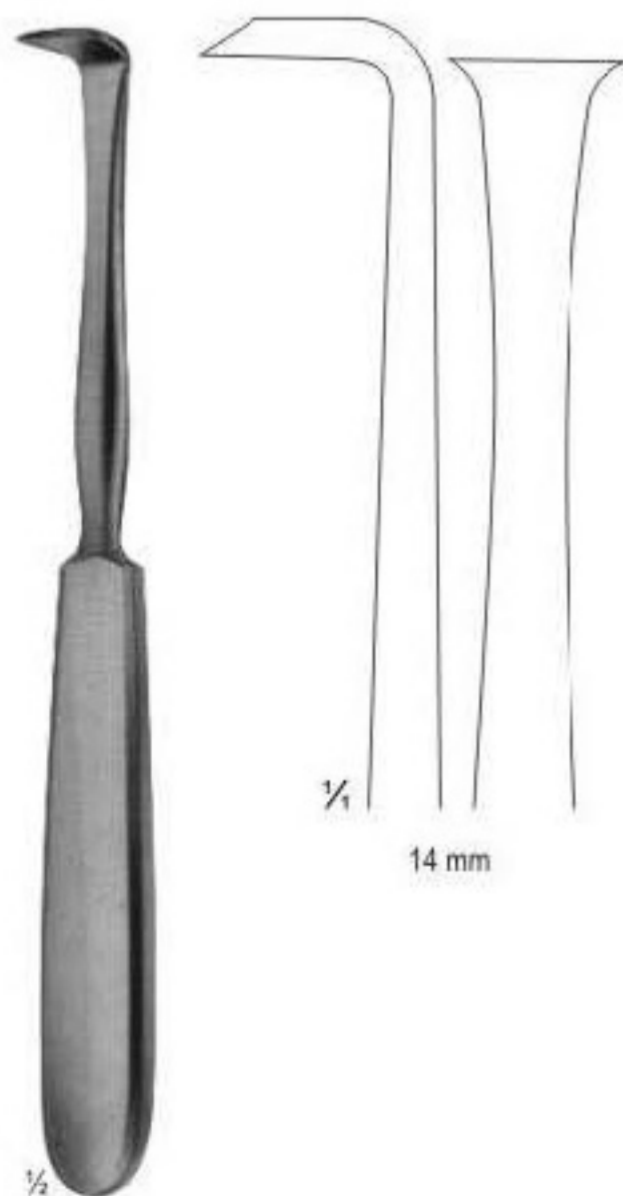

LANGENBACK
17-1599
18 cm

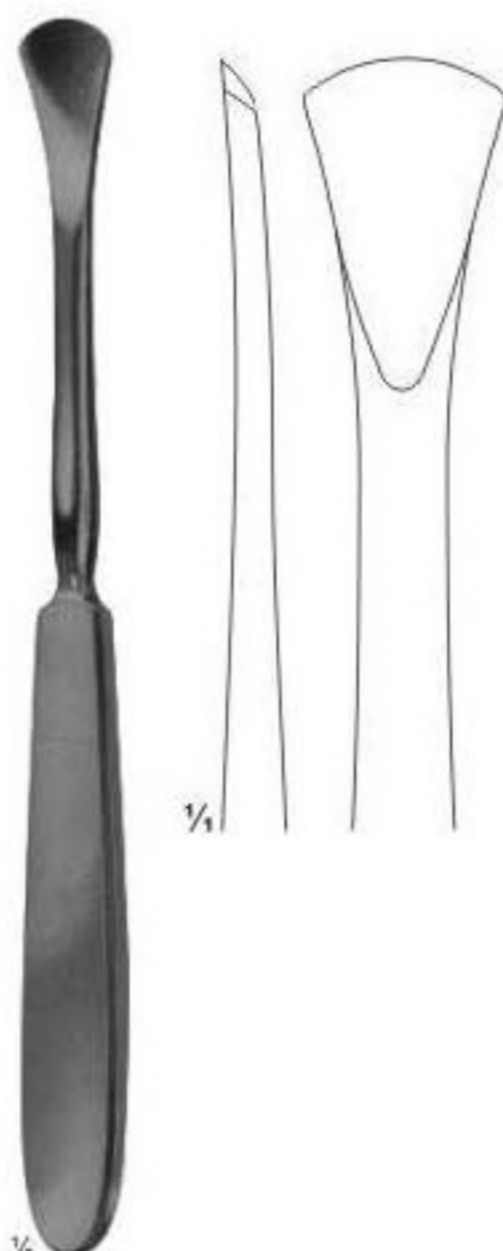

LANGENBECK
17-1600
19 cm

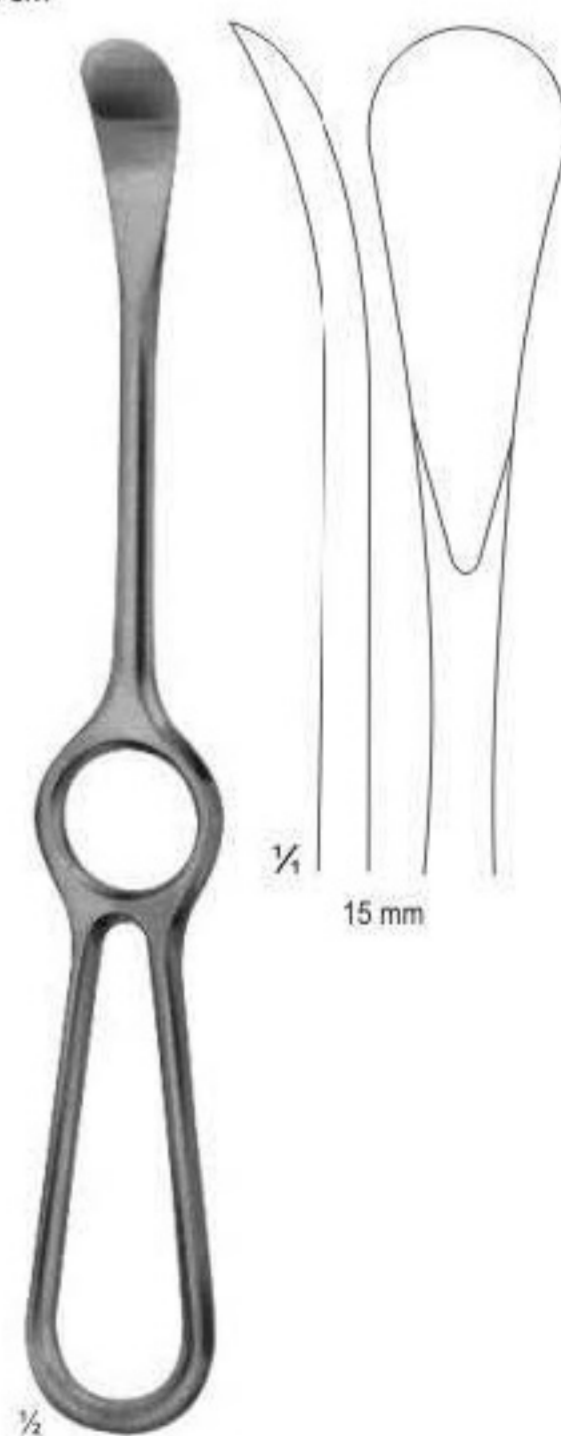

SEDILLOT
17-1601
21.5 cm

Rib Raspatories



SEMB
17-1602 - 17-1606
23 cm

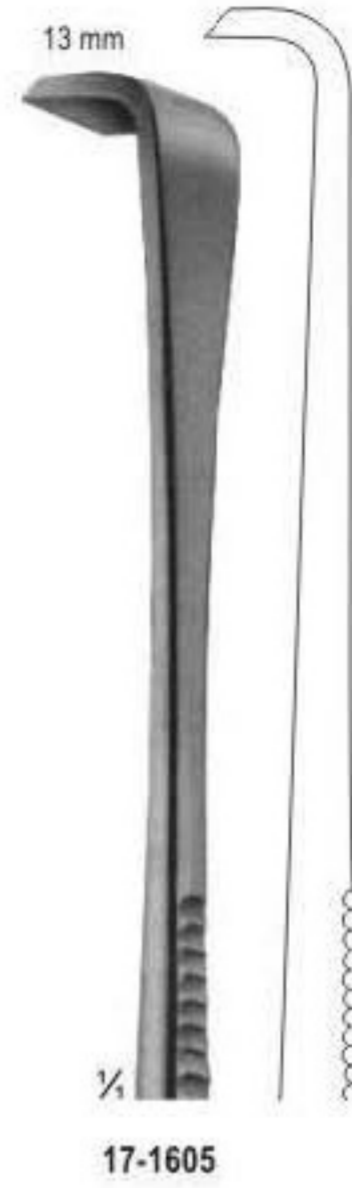

SCHNEIDER
17-1607
17.5 cm

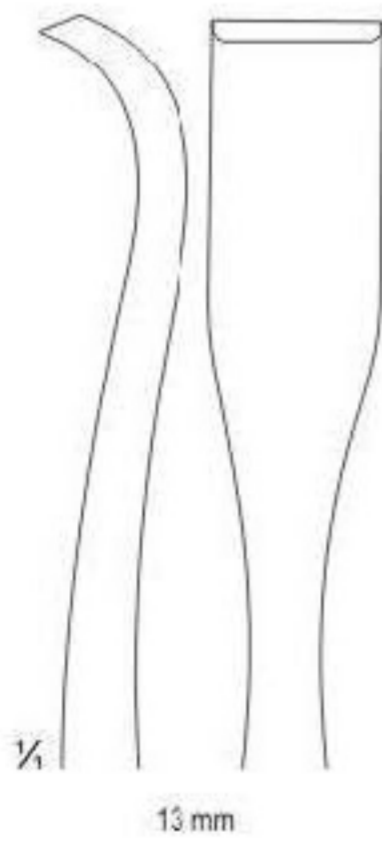

JANSEN
17-1608
16.5 cm



ALEXANDER
17-1609
21 cm

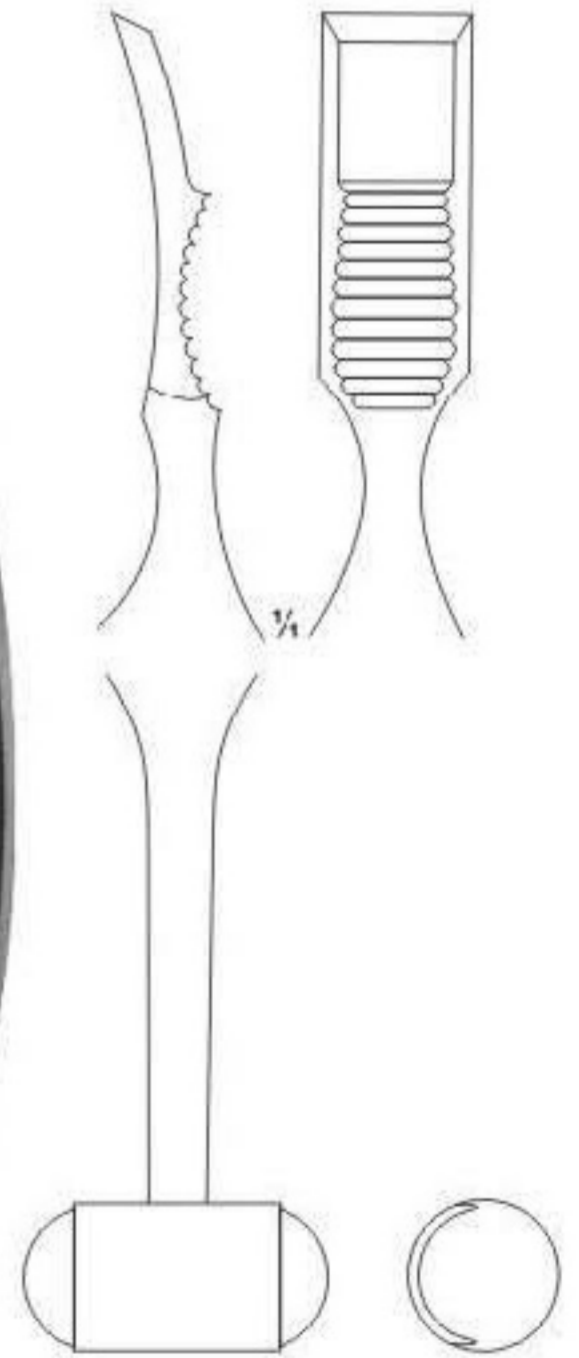

Rib Raspatories

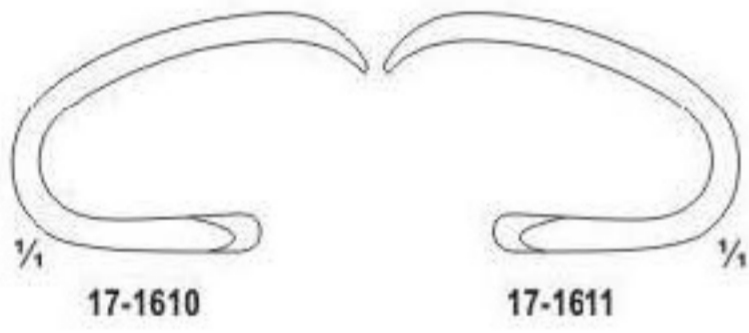

17-1610

17-1611



1/2

DOYEN
for children
17-1610 - 17-1611
17.5 cm



17-1612

17-1613

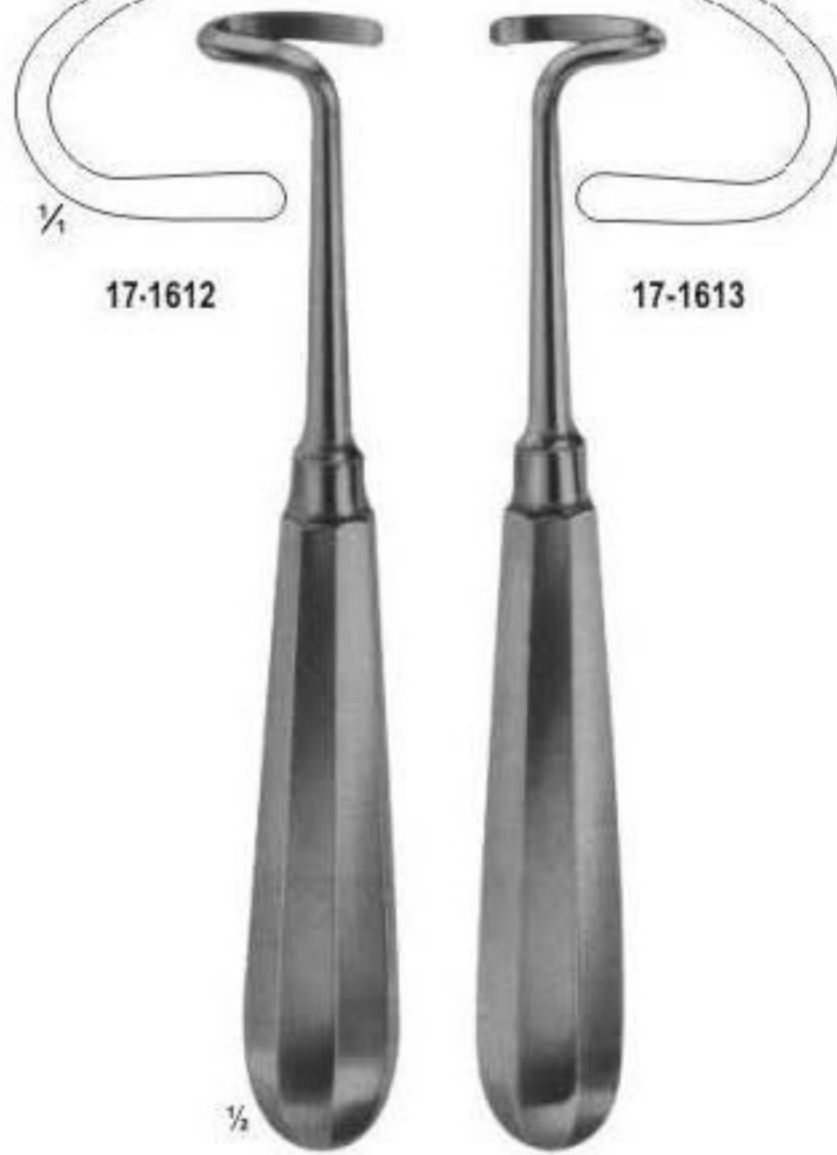

1/2

DOYEN
17-1612
for children
17-1613
for adults
17.5 cm

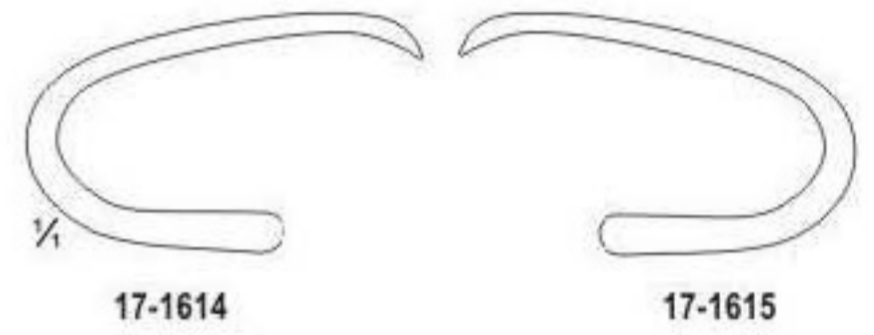

17-1614

17-1615



1/2

DOYEN
17-1614 - 17-1615
24 cm

Elevators And Bone Levers



Raspatories



PARTSCH
17-1624 - 17-1625
15 cm



PARTSCH mod. LANGE
17-1626
14.5 cm



MC KENTY
17-1627
15.5 cm

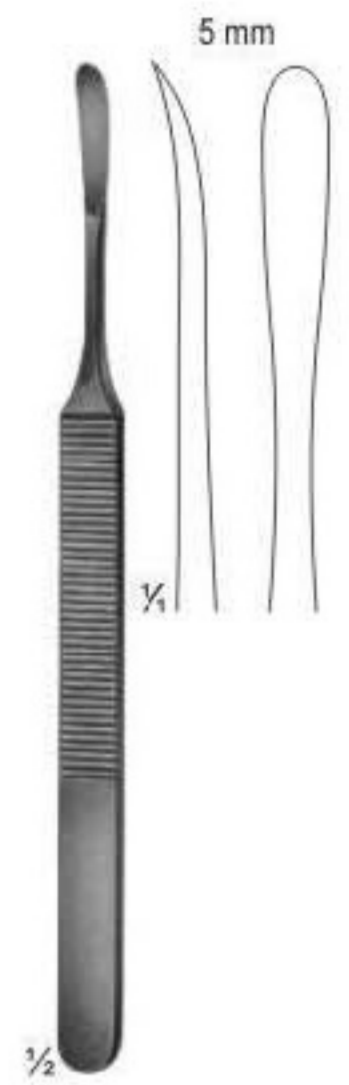

KONIG
17-1628
15.5 cm

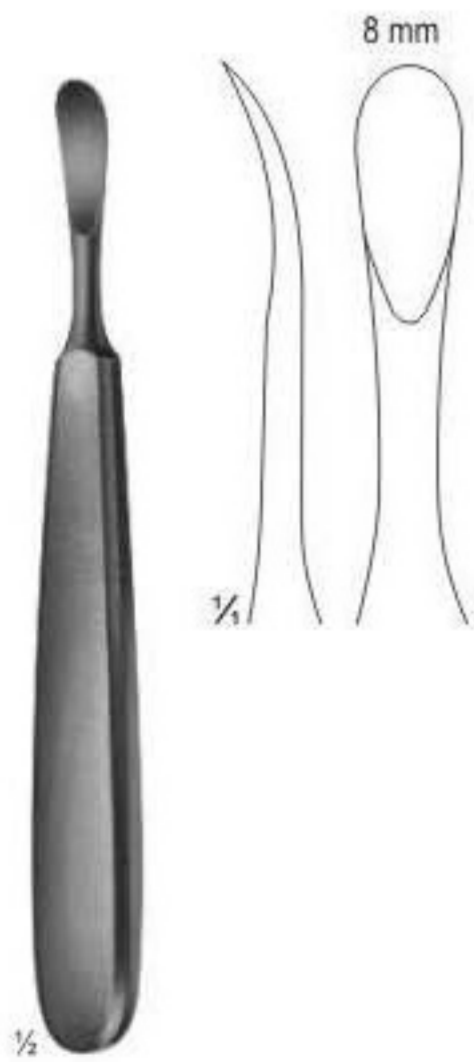

TRELAT
17-1629
15 cm

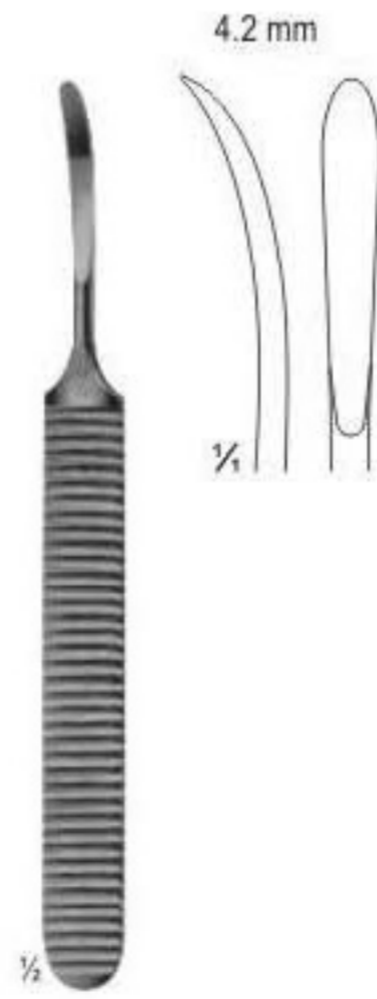

WILLIGER
17-1630
14 cm

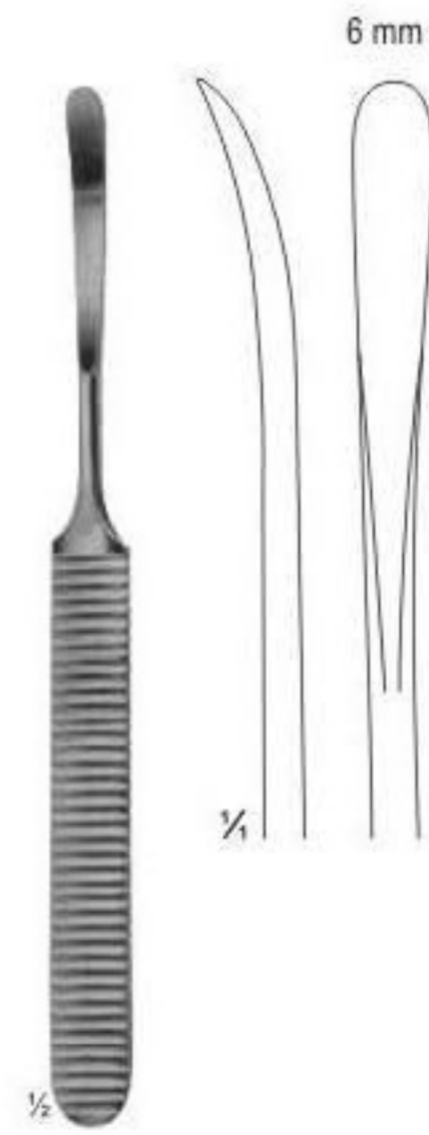

WILLIGER
17-1631
16 cm

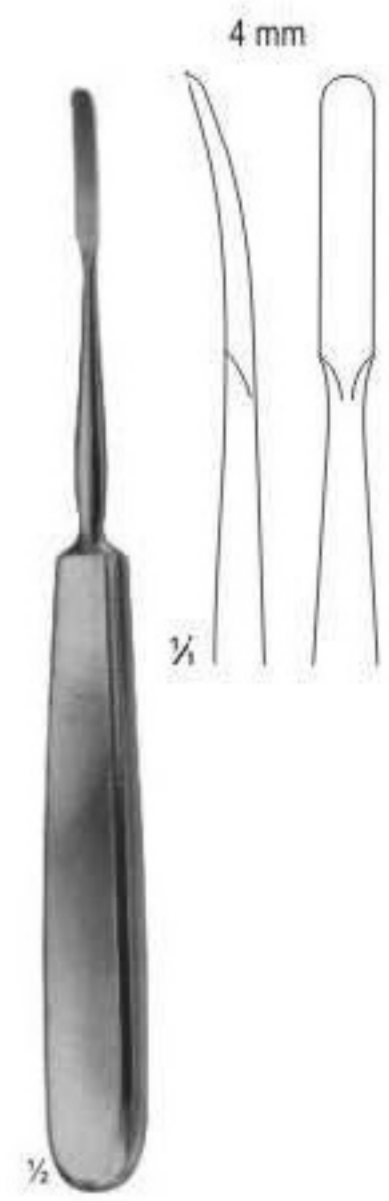

JOSEPH
17-1632
17 cm

Raspatories



KILLIAN
sharp/blunt
17-1633
18.5 cm

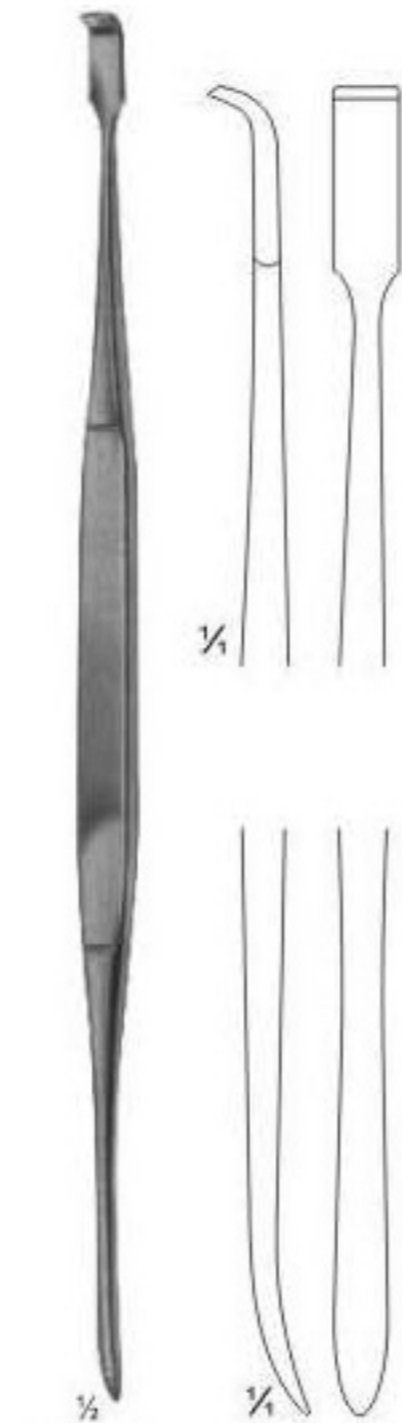

HOWARTH
sharp/blunt
17-1634
21.5 cm

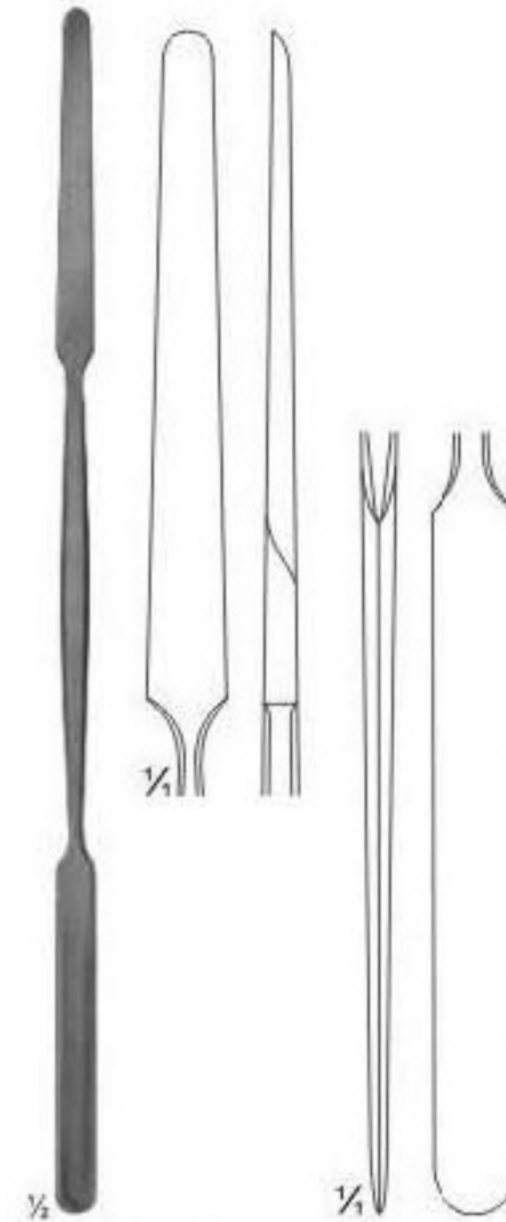

KILLIAN
sharp/blunt
17-1635
18.5 cm

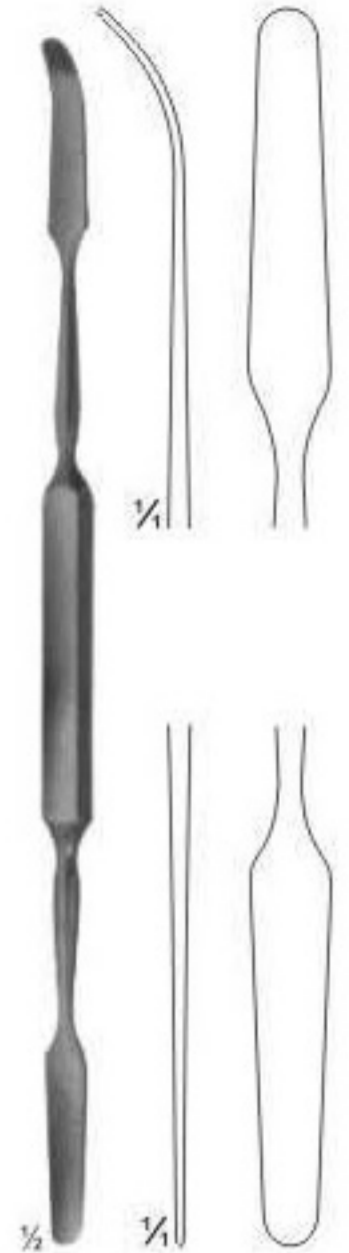

MAC DONALD
blunt/blunt
17-1636
18.5 cm

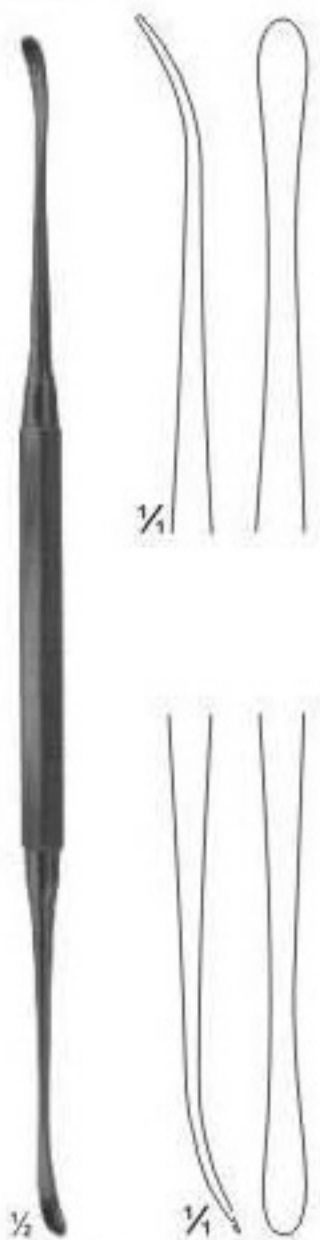

FREER
sharp/blunt
17-1637
18.5 cm

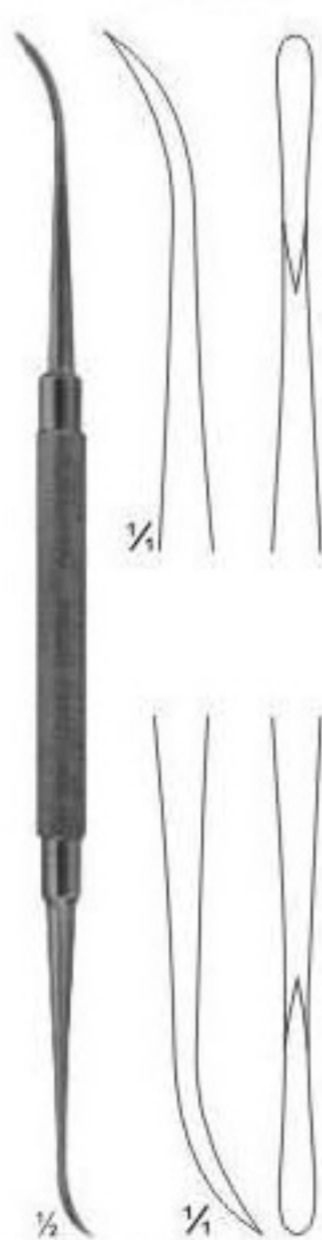

FREER-YASARGIL
sharp/sharp
17-1638
18.5 cm

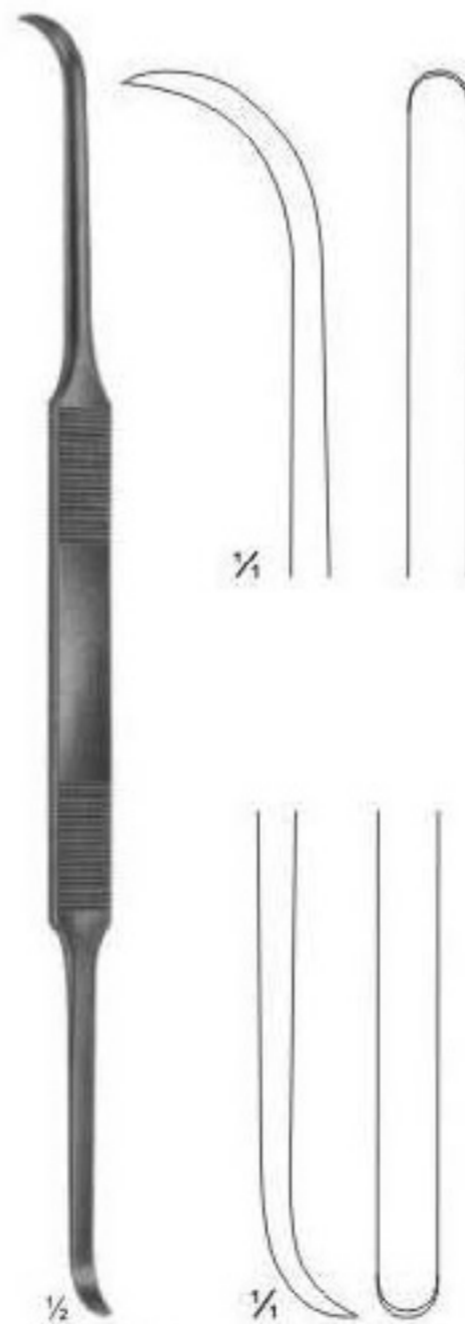

COTTLE
sharp/sharp
17-1639
20 cm



MEAD
sharp/sharp
17-1640
16.5 cm

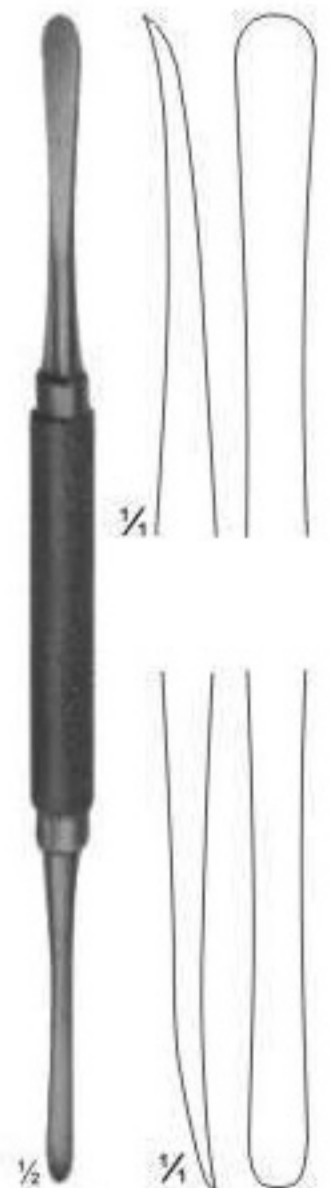

MOLT
sharp/sharp
17-1641
18 cm

Raspatories

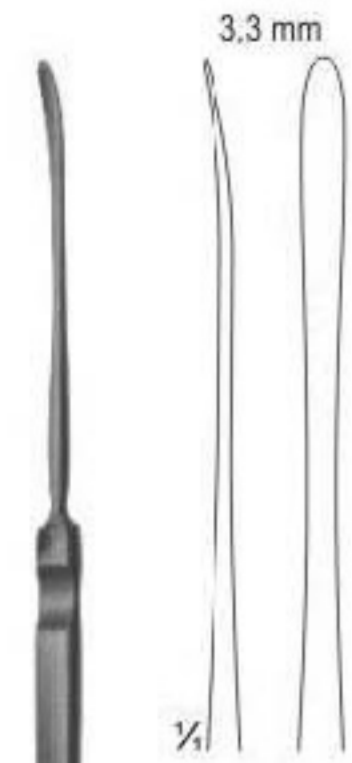

HALLE
stumpf/blunt
17-1642
18 cm



FREER
stumpf/blunt
17-1643
19 cm



FREER
stumpf/sharp
17-1644
19 cm



SEWALL
stumpf/blunt
17-1645
19 cm



17-1646



17-1647



17-1648



PAULSEN
17-1646 - 17-1648
20.5 cm



17-1649



17-1650



PAULSEN
17-1649 - 17-1650
20.5 cm

Raspatories



17-1651

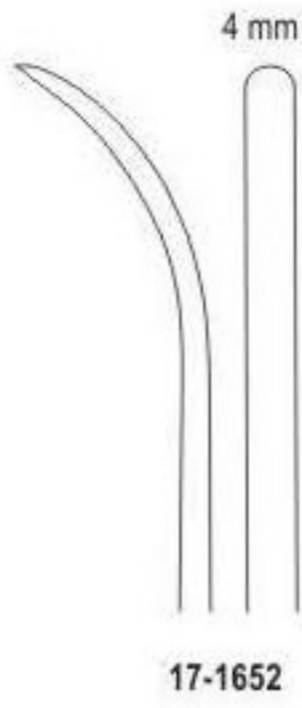

17-1652

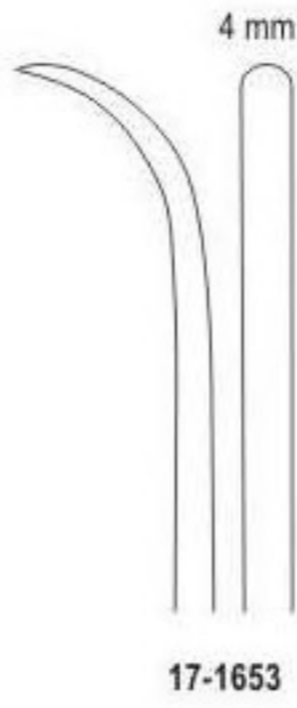

17-1653

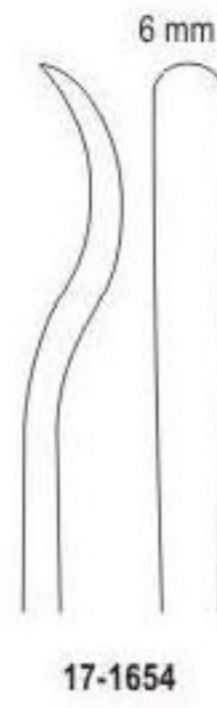

17-1654

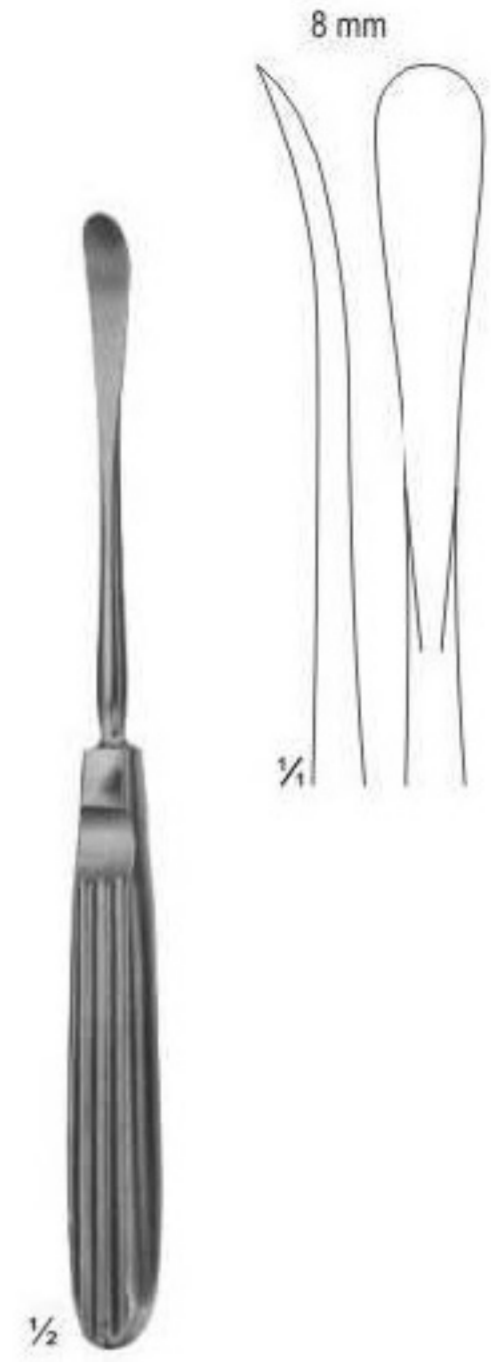

COTTLE
17-1655
17.5 cm

MUHLING
17-1651 - 17-1654
17 cm

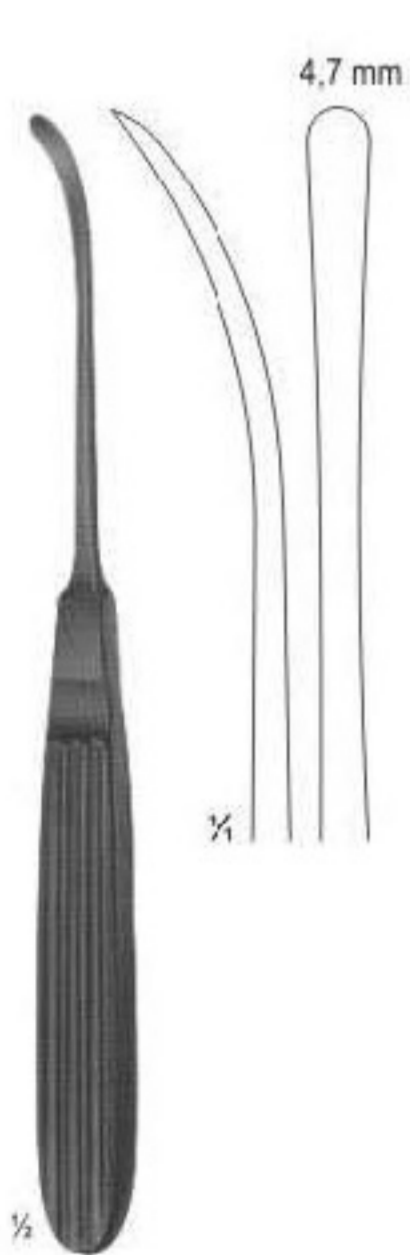

LANDOT
17-1656
17.5 cm



CASPER
17-1657
18 cm

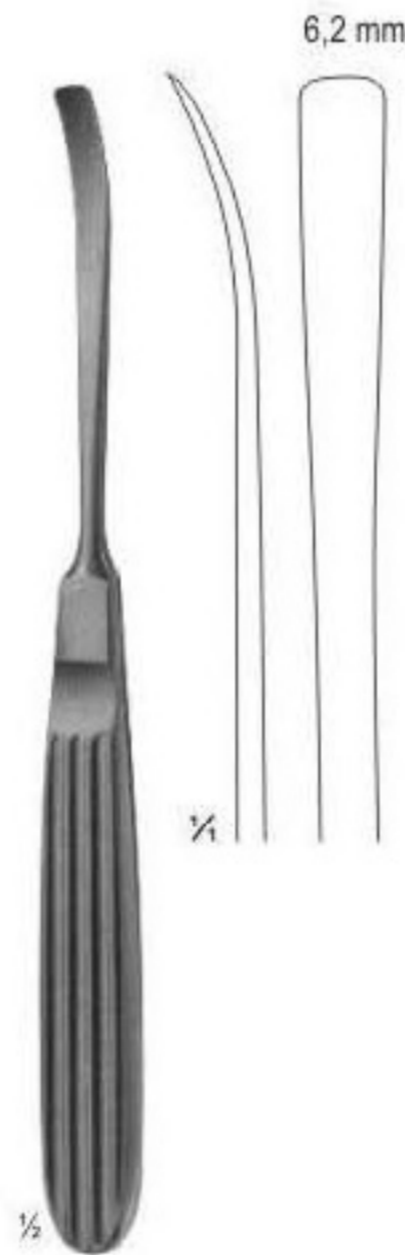

CASPER
17-1658
18 cm

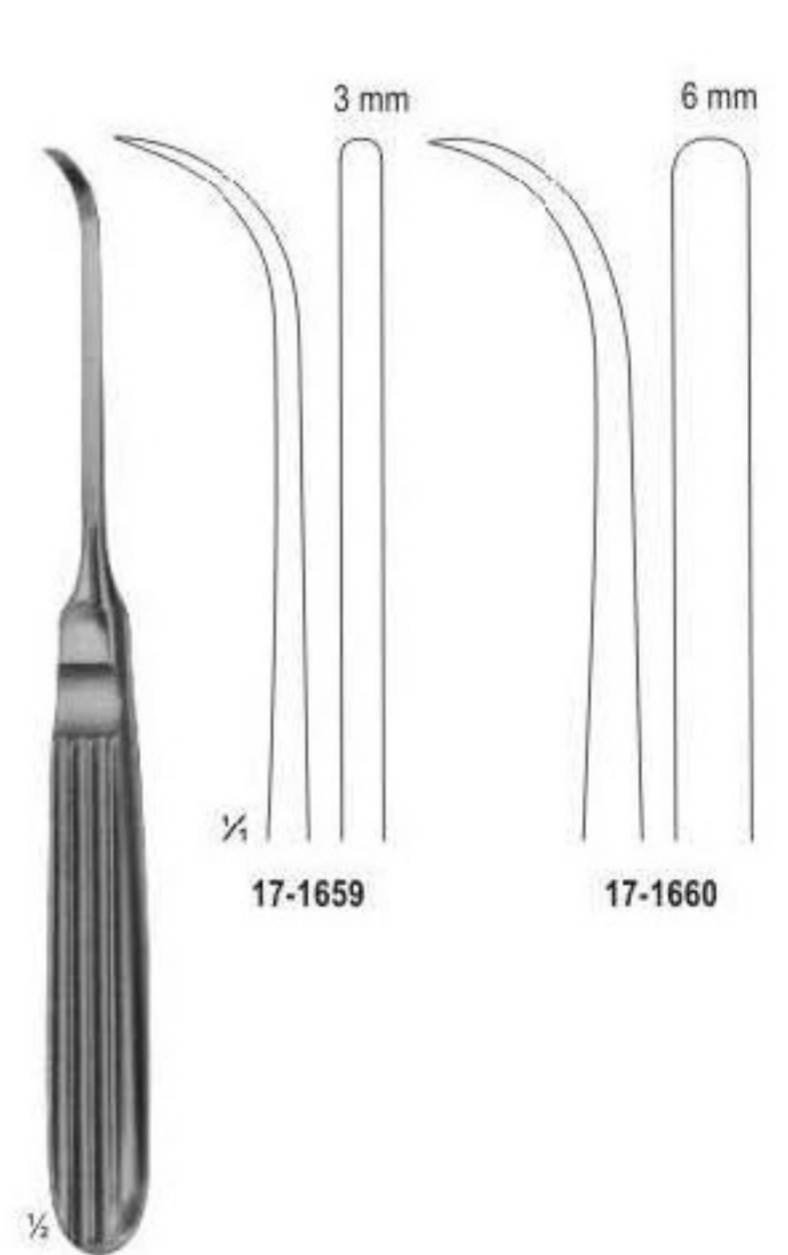

17-1659 - 17-1660
17 cm

Alveotomy Files, Elevators



MILLER
17-1681
19 cm

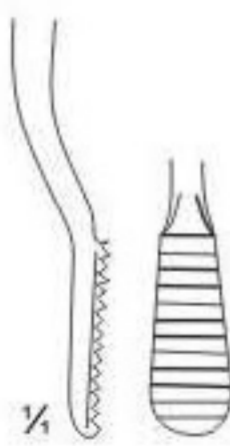
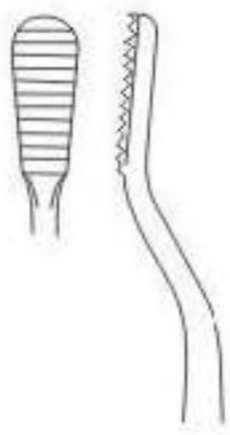

1/2



MILLER
17-1682
19 cm



1/2



LANGENBACK
17-1683 - 17-1684

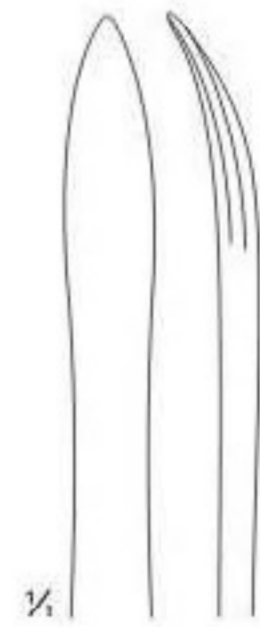

1/2

17-1683
7 mm



17-1684
10 mm

Periosteal Elevators



1/2

WILLIGER
17-1685
12.5 cm
Solid
6 mm



1/4



1/2

17-1686 - 17-1687
17 cm
With Hollow Handle

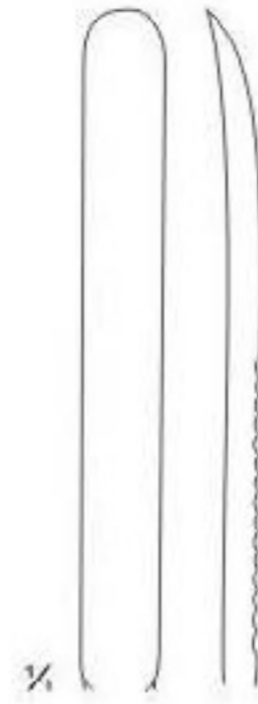

1/4

17-1686
6 mm



17-1687
8 mm



1/2

KAHRE-WILLIGER
17-1688 - 17-1689
16.5 cm
Solid

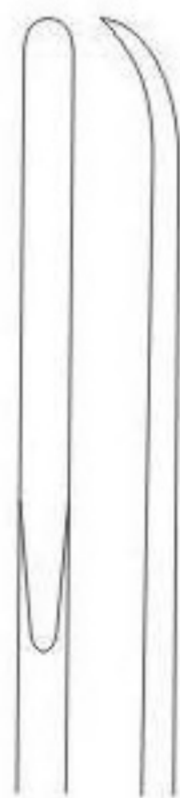

4 mm
17-1688
16.5 cm

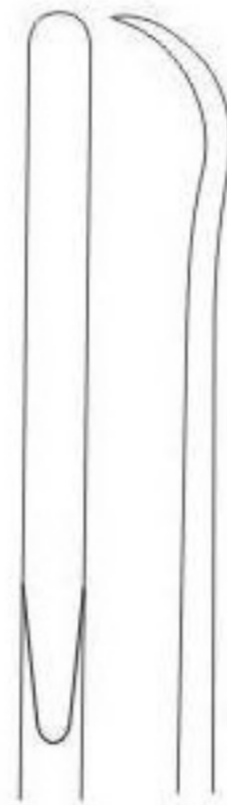

5 mm
17-1689
16.5 cm



1/2

17-1690 - 17-1692
Delicate, Angled, Solid
16 cm



1/4

17-1690
5 mm



17-1691
6 mm



17-1692
7 mm

Bone File And Rasps

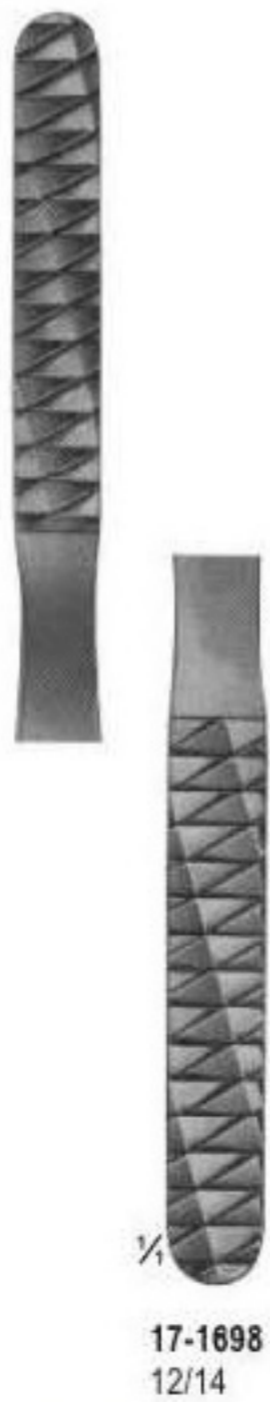
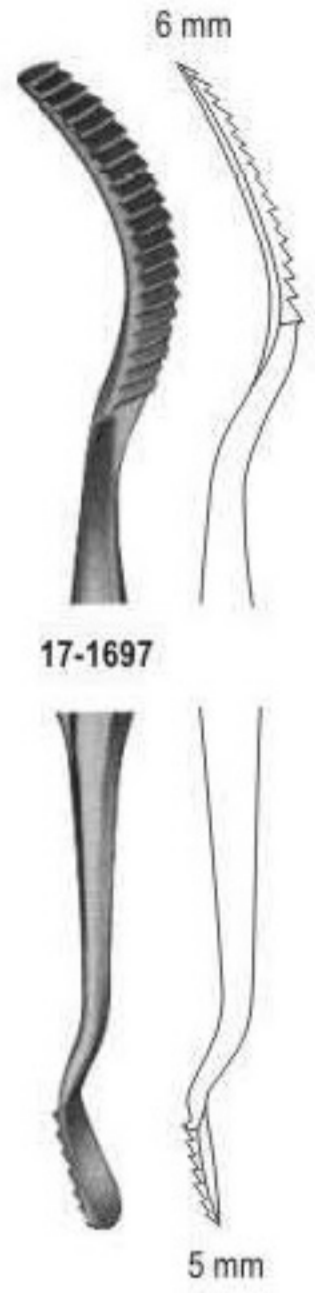
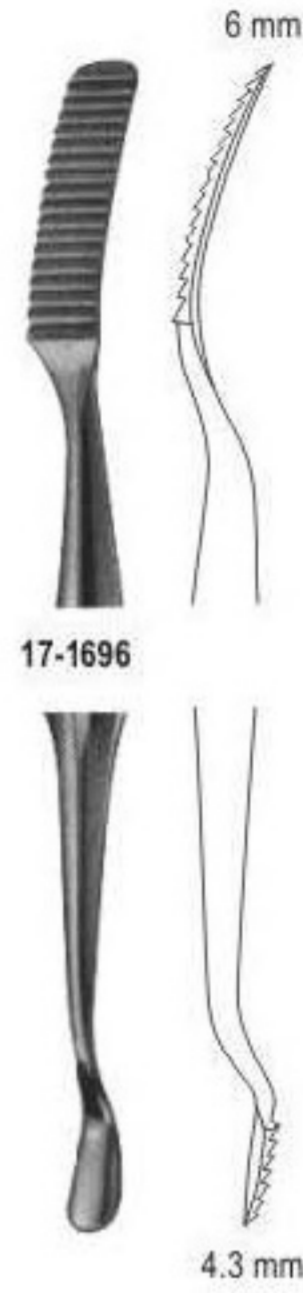
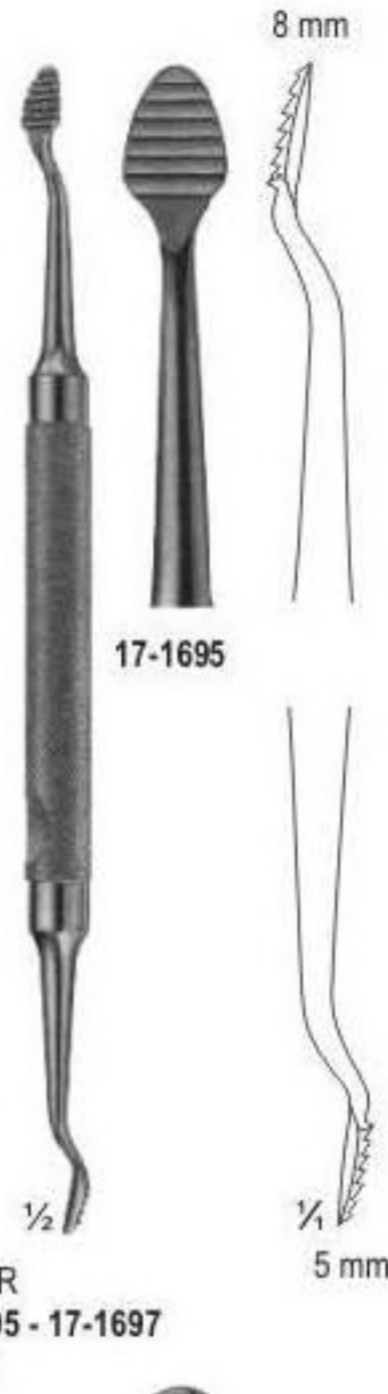

Bone File And Rasps



JOSEPH
17-1703 - 17-1704
fine, chequered
coarse, chequered
16.5 cm



17-1703
7.5 mm



17-1704
9 mm



LEWIS
17-1705 - 17-1706
fine, teeth



17-1705
8 mm



17-1706
8 mm
coarse, teeth
17.5 cm



MALTZ
down stroke
17-1707
18 cm



9 mm



AUFRICHT
17-1708 - 17-1709
up stroke
17-1710
down stroke
22 cm



17-1708
9 mm



17-1709
9 mm



6,5 mm

GALLAHER
17-1711
19 cm

Bone File And Rasps

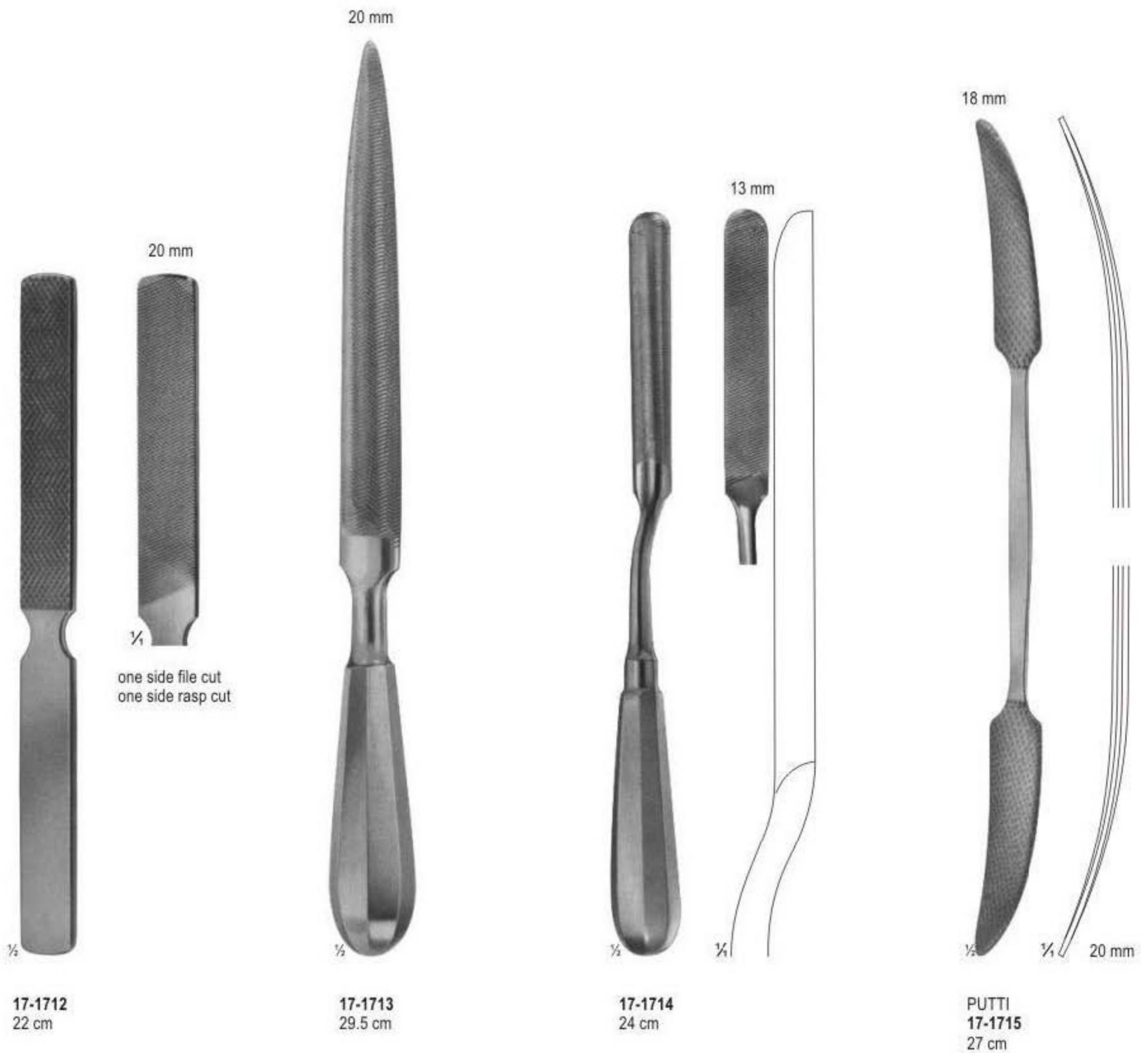

Bone Levers

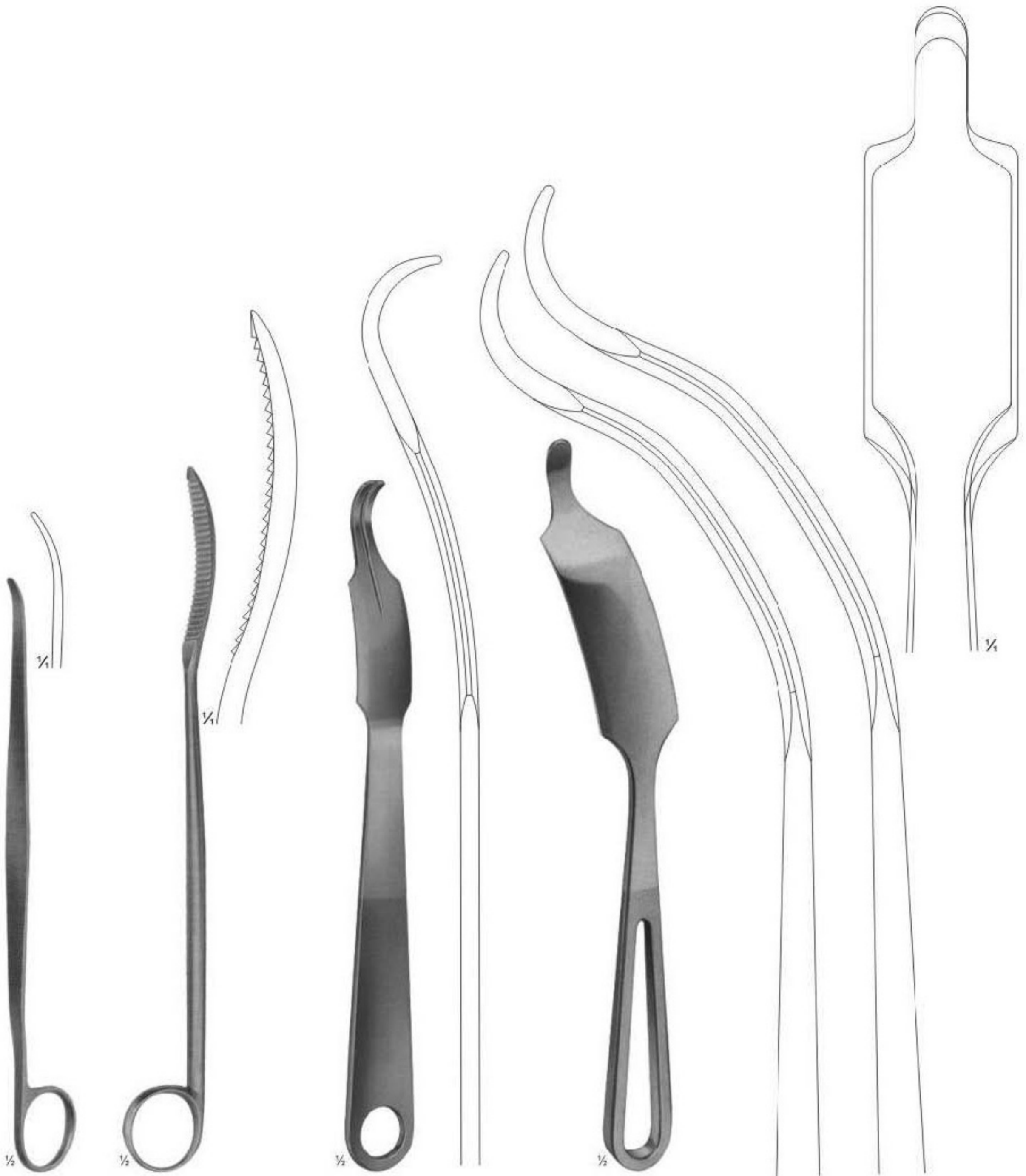

LANE TRETOWAN
17-1716
21.5 cm

LANE
17-1717
25.5 cm

LANGE-HOHMANN
17-1718
25 cm

LANGE-HOHMANN
17-1719 - 17-1720
17-1719 26.5 cm
17-1720 28 cm

Bone Levers

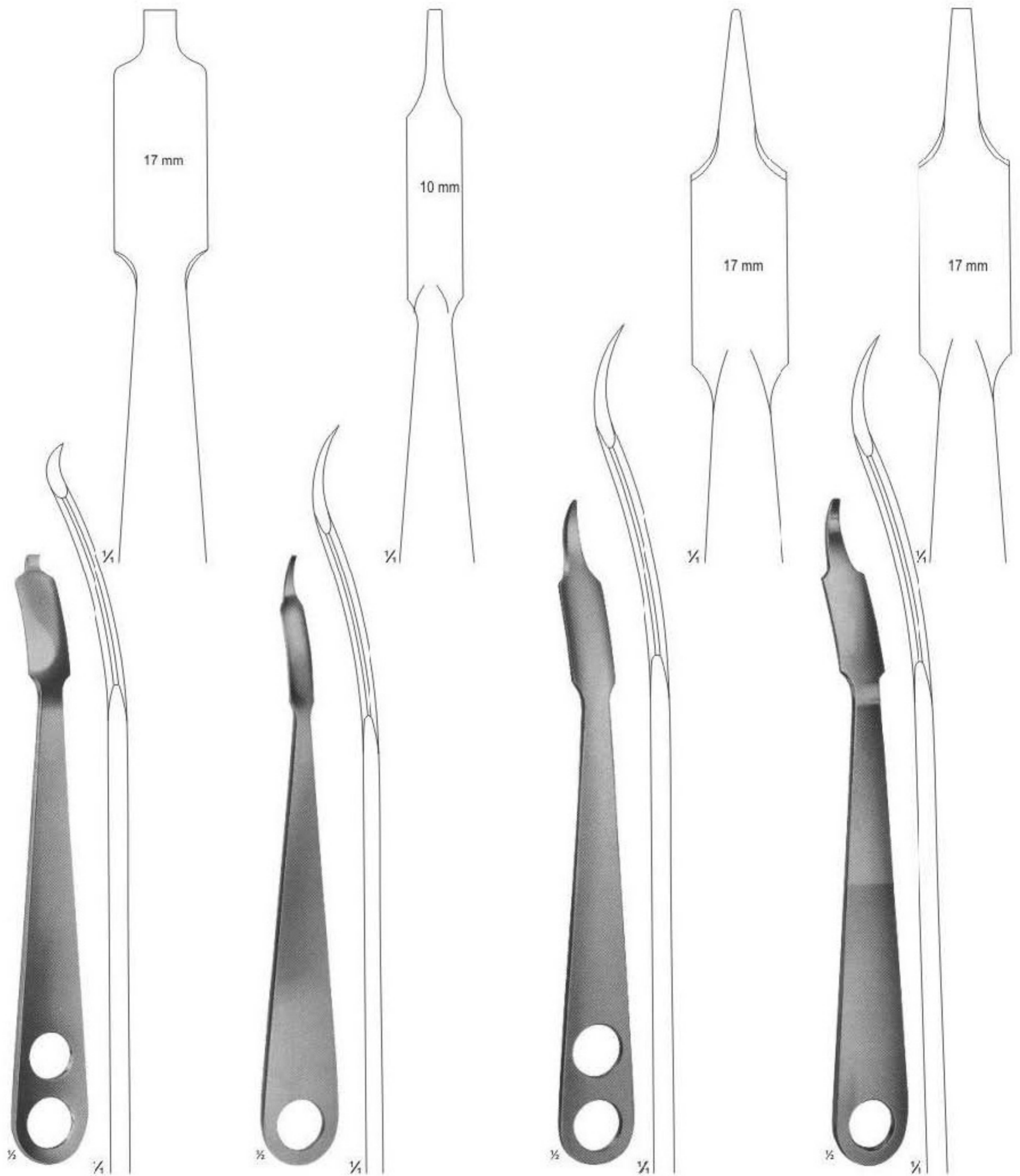

WAGNER
17-1721
22 cm

17-1722
22 cm

17-1723
24 cm

17-1724
24 cm

Bone Levers

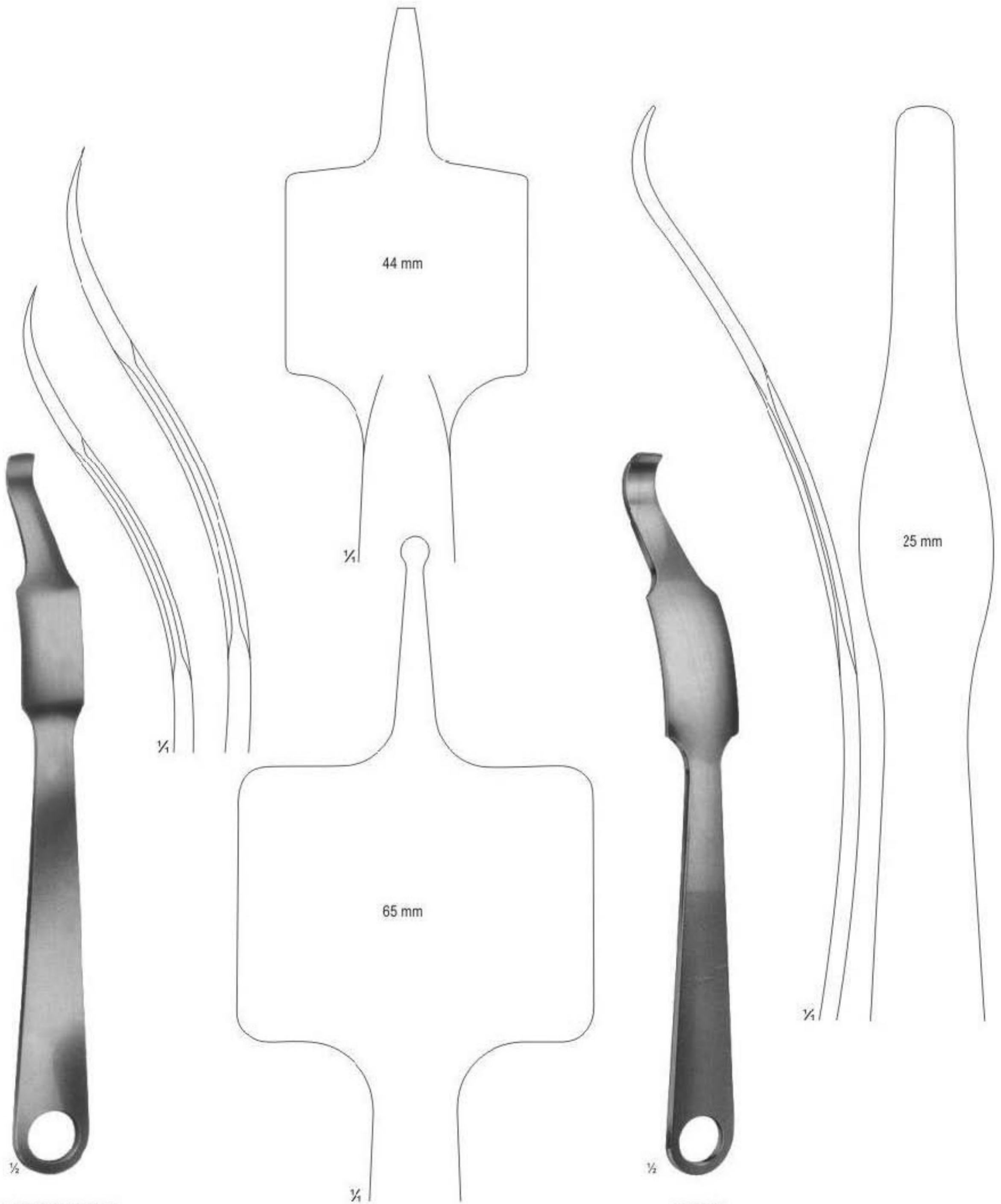

VERBRUGGE-MULLER
17-1725 - 17-1726
17-1725 24 cm
17-1726 25.5 cm

17-1727
26 cm

Bone Levers

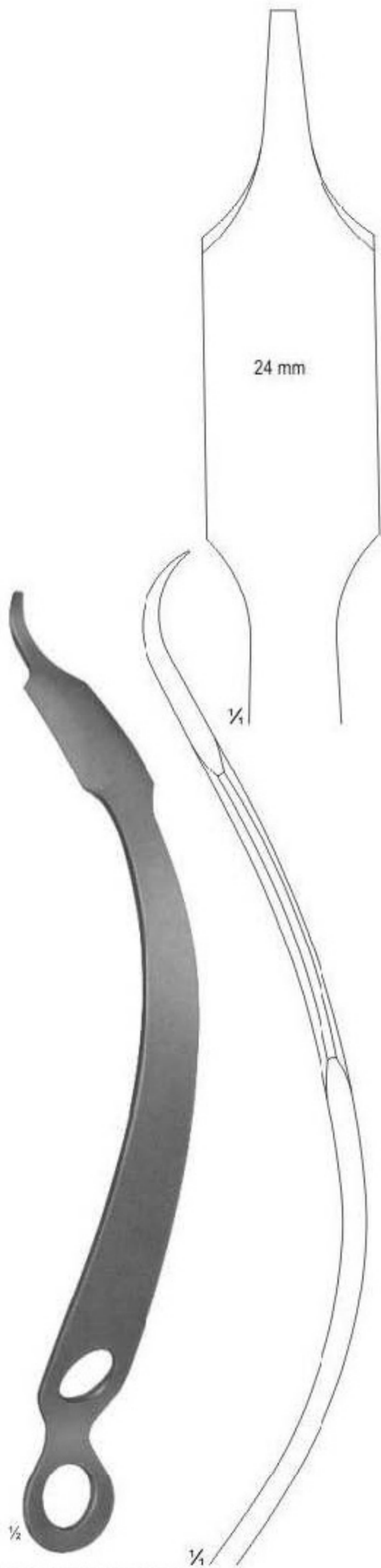

HOHMANN-ALDINGER
17-1728
27 cm

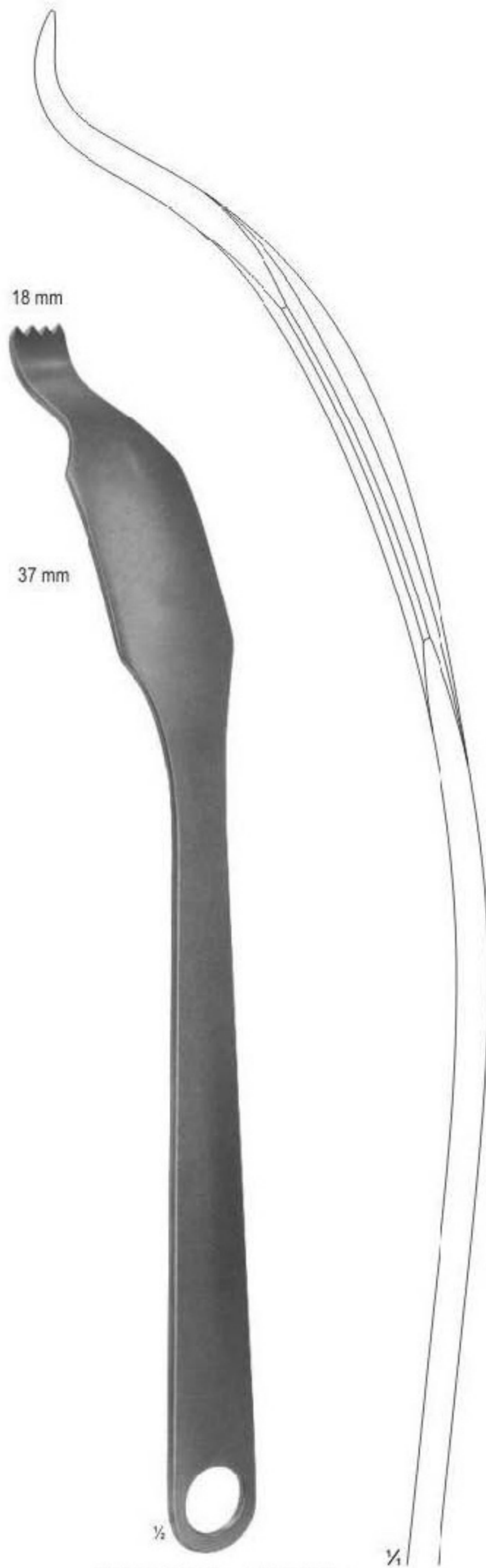

SCHUMACHER mod. WAGNER
17-1729
34.5 cm

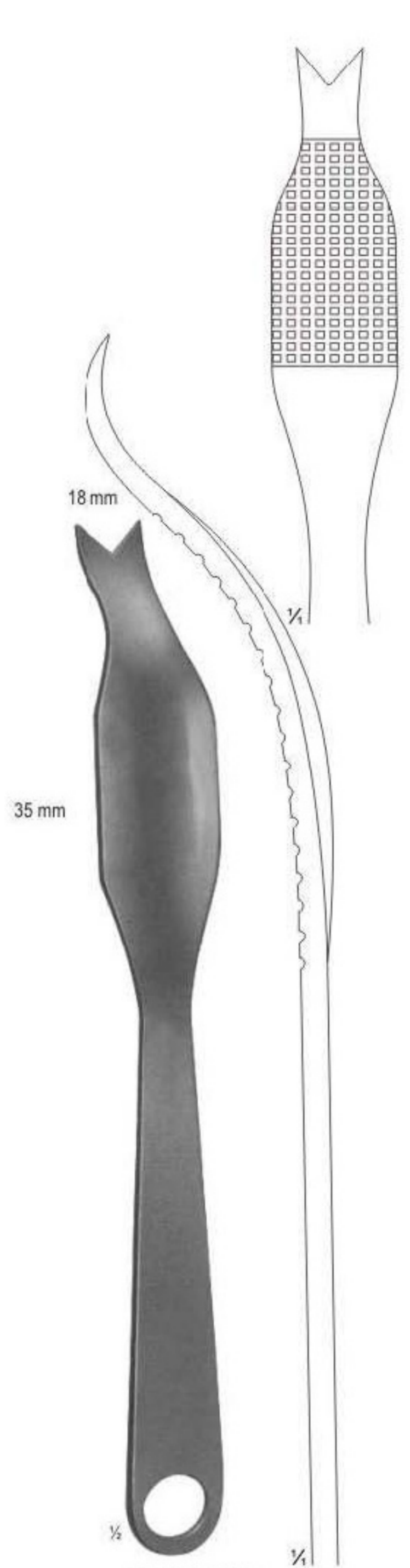

SCHUMACHER
17-1730
29 cm

Bone Levers

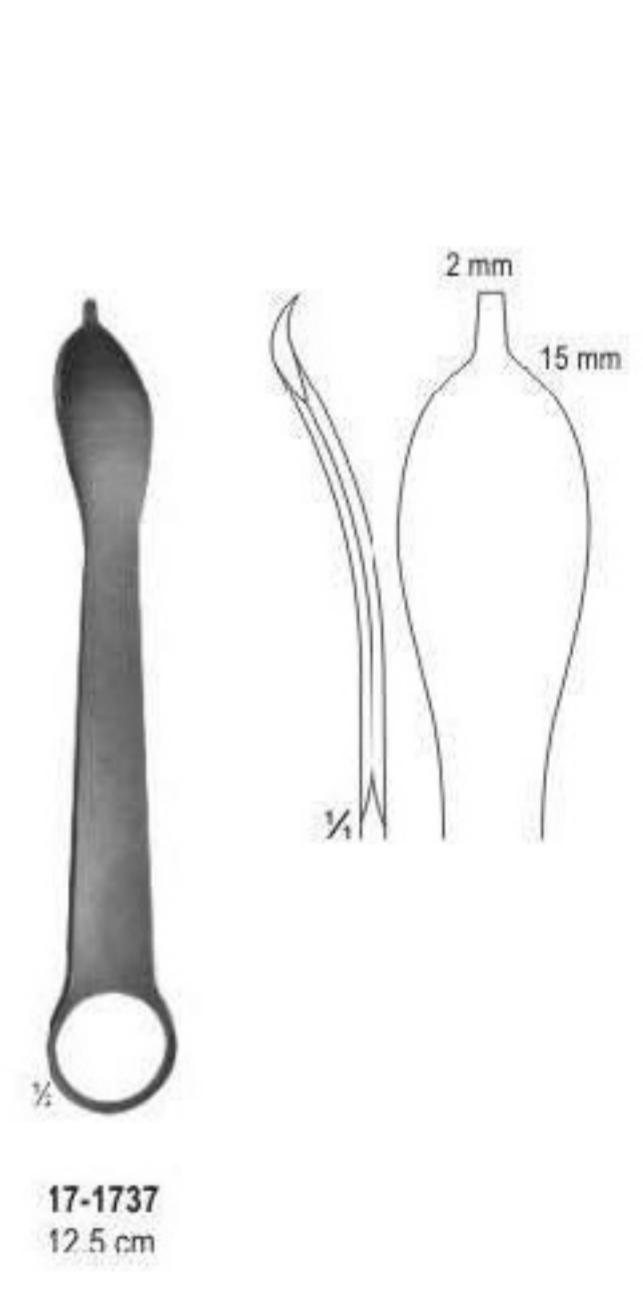
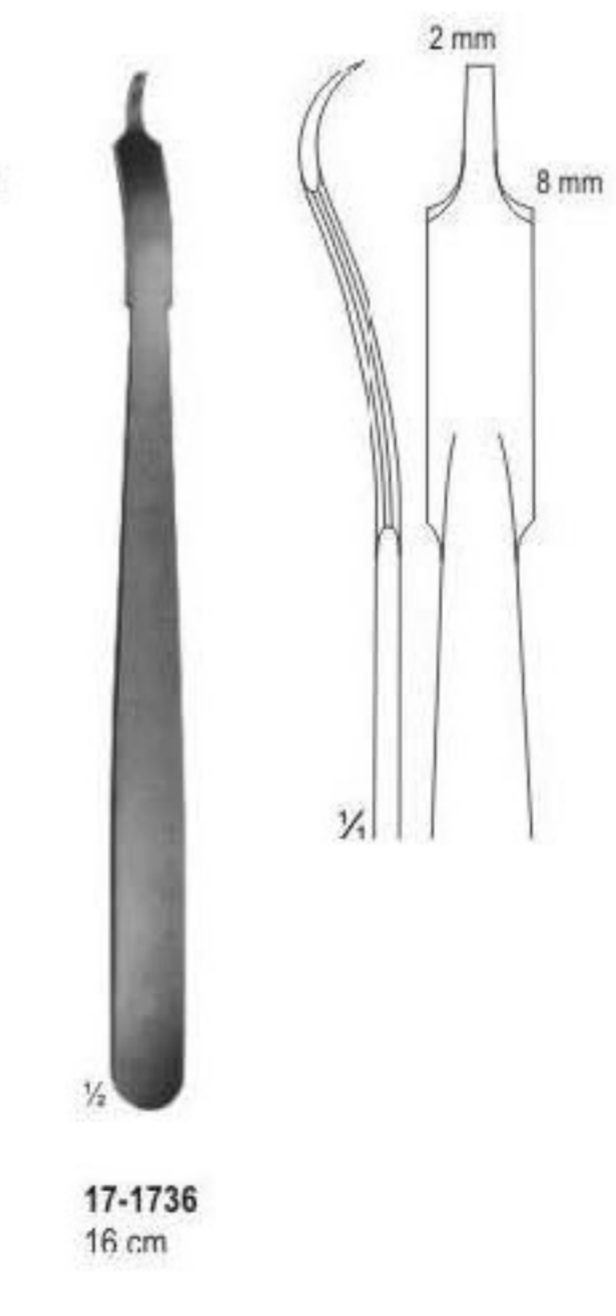
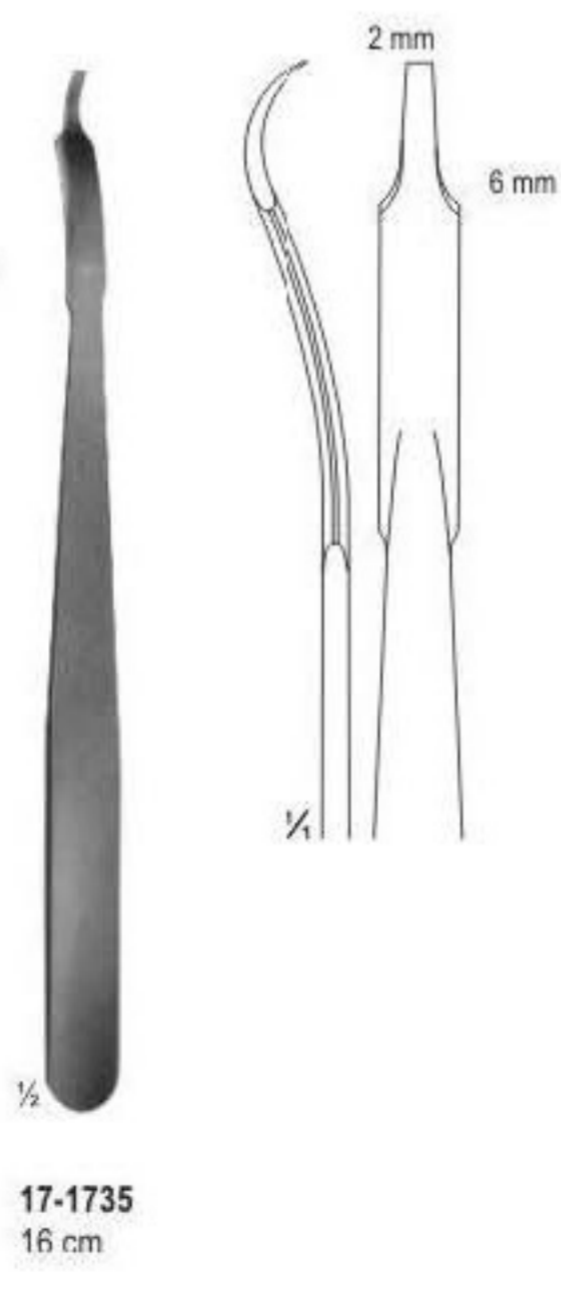
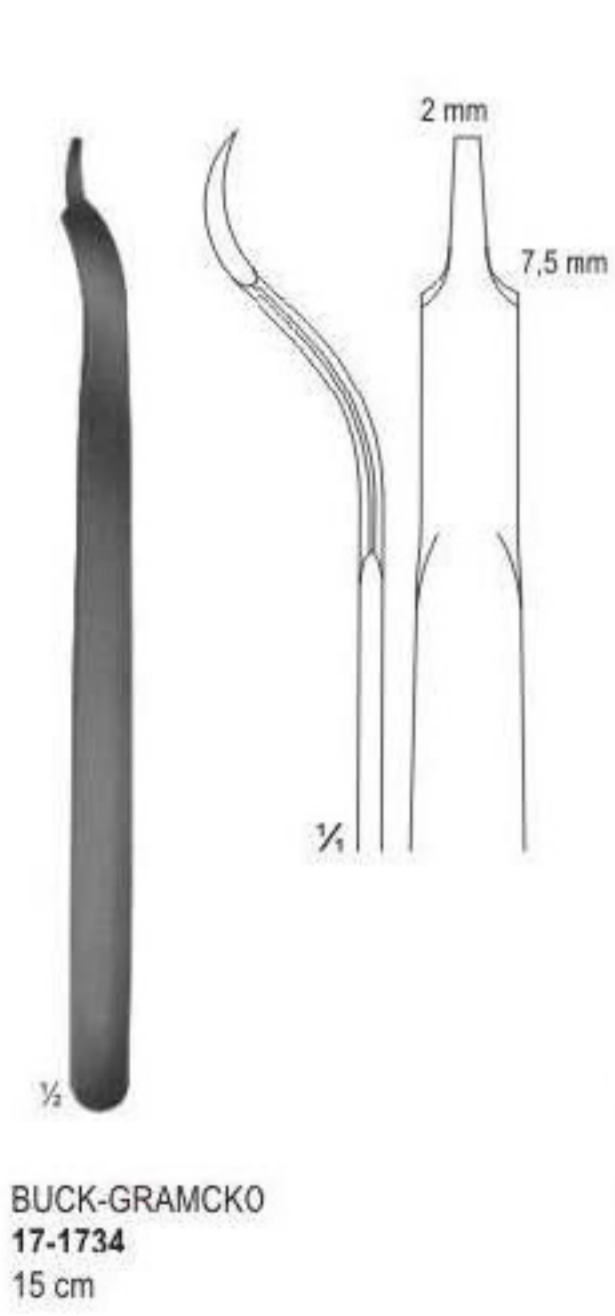
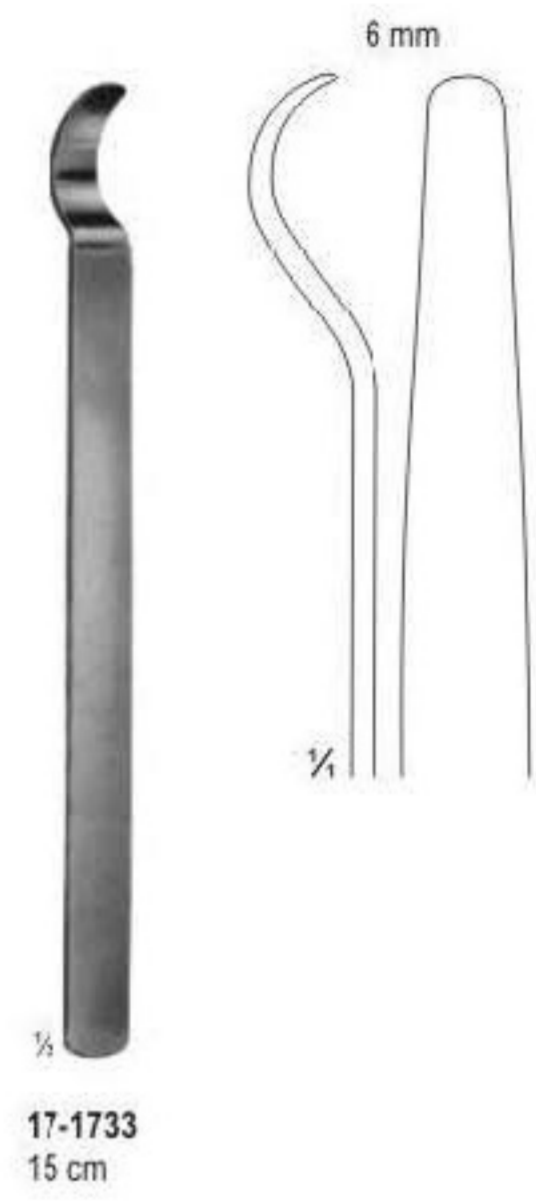
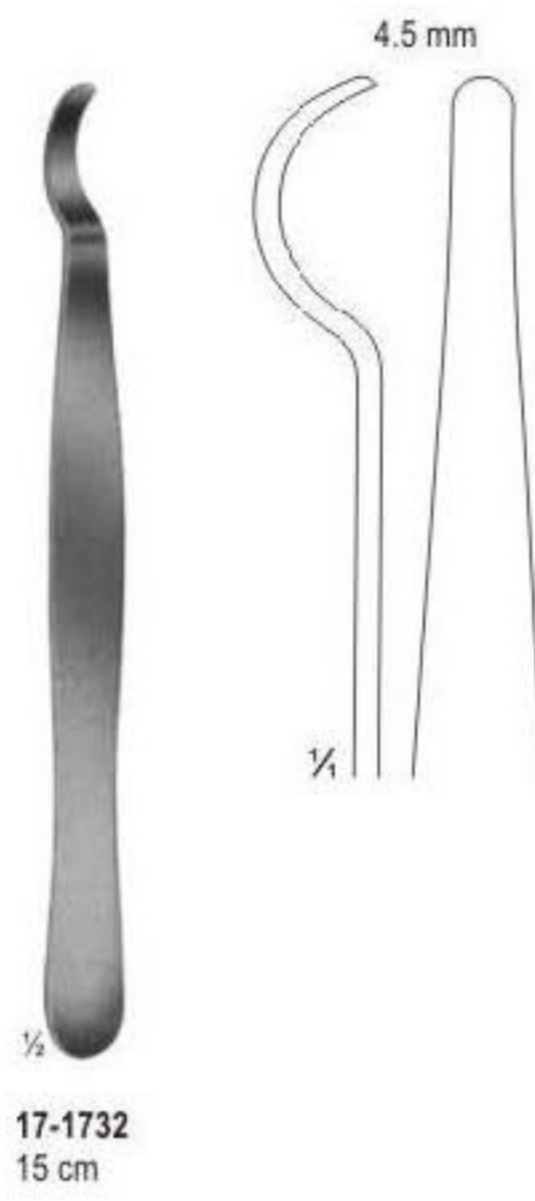
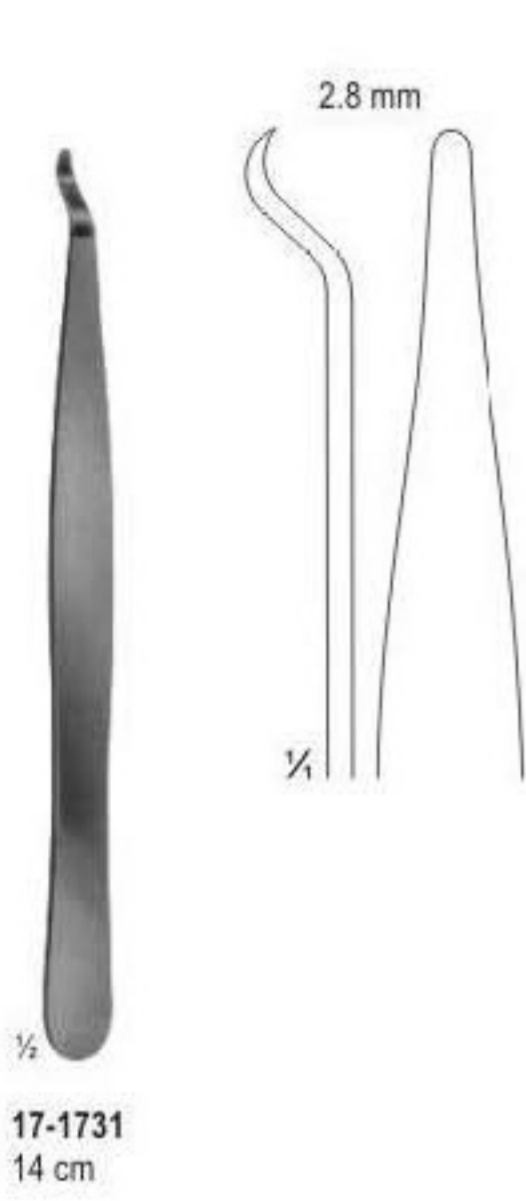

Special Bone Levers



TAGER
Bone lever for
angle joint operations
17-1738
17.5 cm



BENNETT
17-1739
23.5 cm

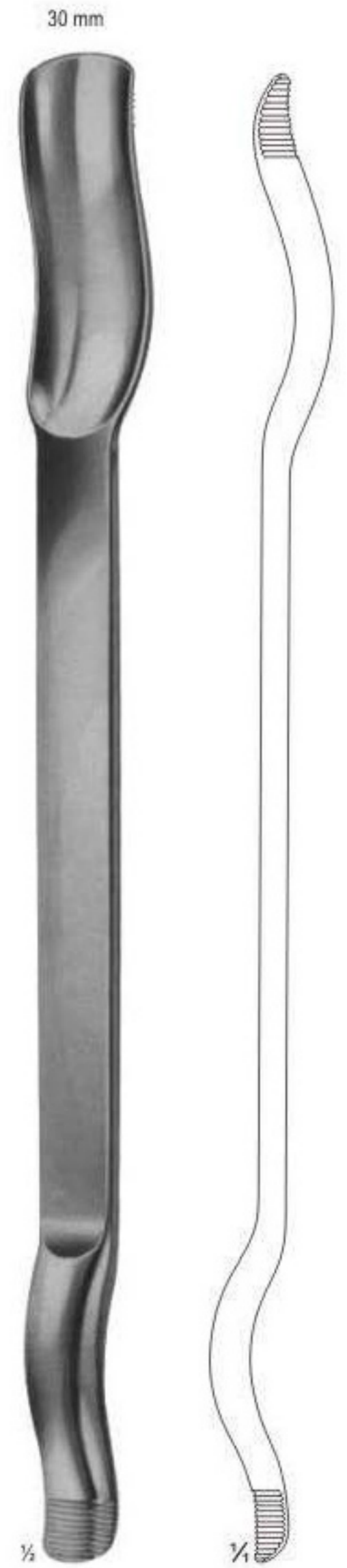

MURPHY-LANE
Luxation lever
17-1740
34 cm

Drilling Chucks



REILL
17-1741
Drilling chuck, cannulated, for shanks from 2.0 - 2.5 mm diam
11.5 cm



17-1742
Drilling chuck, cannulated, for shanks from 0.8 - 2.0 mm diam
15 cm



17-1743
Drilling chuck, cannulated, for shanks up to 4.5 mm diam with key
14 cm



LOUTE
17-1744
Wire tightener, improved pattern, with movable tip, for wires up to 1.0 mm diam.
22 cm



17-1745
Drilling chuck, cannulated, for shanks up to 6.35 mm diam., To be tightened by hand
10 cm



17-1746
Drilling chuck, cannulated, for shanks up to 4.5 mm diam., And for triangular shaft width across flats 4.7 mm



17-1747
Drilling chuck, cannulated, for shanks up to 6.35 mm diam., With key
16 cm

Tendon Strippers

¼ 
 Fig. 1
17-1748
 15 cm
 4.5 mm

 Fig. 2
17-1749
 15 cm
 5.5 mm



 Fig. 3
17-1750
 15 cm
 6.5 mm

 Fig. 4
17-1751
 15 cm
 7.5 mm



 Fig. 4
17-1752
 15 cm
 8.5 mm



BUNNELL
17-1748 - 17-1752
 15 cm



17-1753 - 17-1755
 23 cm
 Flexible Shaft

¼ 
17-1753
 23 cm
 4 mm



17-1754
 23 cm
 4.5 mm

17-1755
 23 cm
 5.5 mm



17-1756
 33.5 cm
 Tendon Passing
 Instrument



¼ 
17-1756
 Screw

Tendon Strippers



FISCHER
17-1757
31 cm
Blunt



17-1758
28.5 cm



BUNNELL
17-1759
23 cm
Tendon Passer



Wire Extension

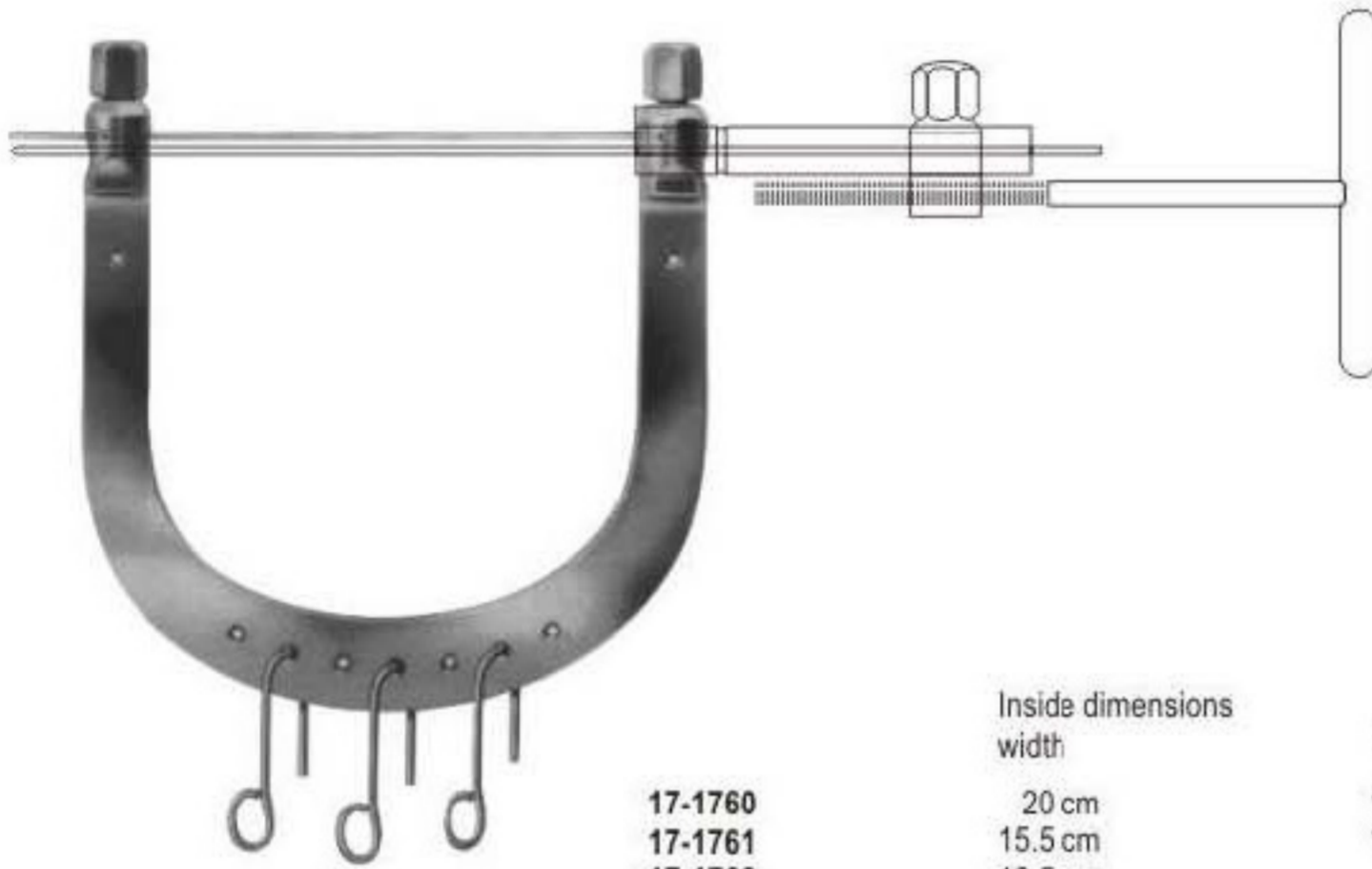

KIRSCHNER
17-1760 - 17-1766
Wire traction bows,
to be used with
KIRSCHNER-wires
up to 2.5 mm diam.,
With 3 hooks,
stainless steel

- 17-1760
- 17-1761
- 17-1762
- 17-1763
- 17-1764
- 17-1765
- 17-1766

Inside dimensions width	Depth
20 cm	15.5 cm
15.5 cm	15.5 cm
13.5 cm	13 cm
12 cm	12 cm
10.5 cm	10 cm
9.5 cm	11 cm
9.5 cm	7 cm



17-1767
Wrench, double - ended,
for wire traction bows



17-1768
Wire tightener, with
clamping jaws



17-1769
Traction hook only,
large size



17-1770
Traction hook only,
small size



17-1771
Fixation clamp, to secure clamping
jaws of stainless steel

Wire Extension



17-1772
Wire traction bow, adjustable,
with 3 hooks, small size

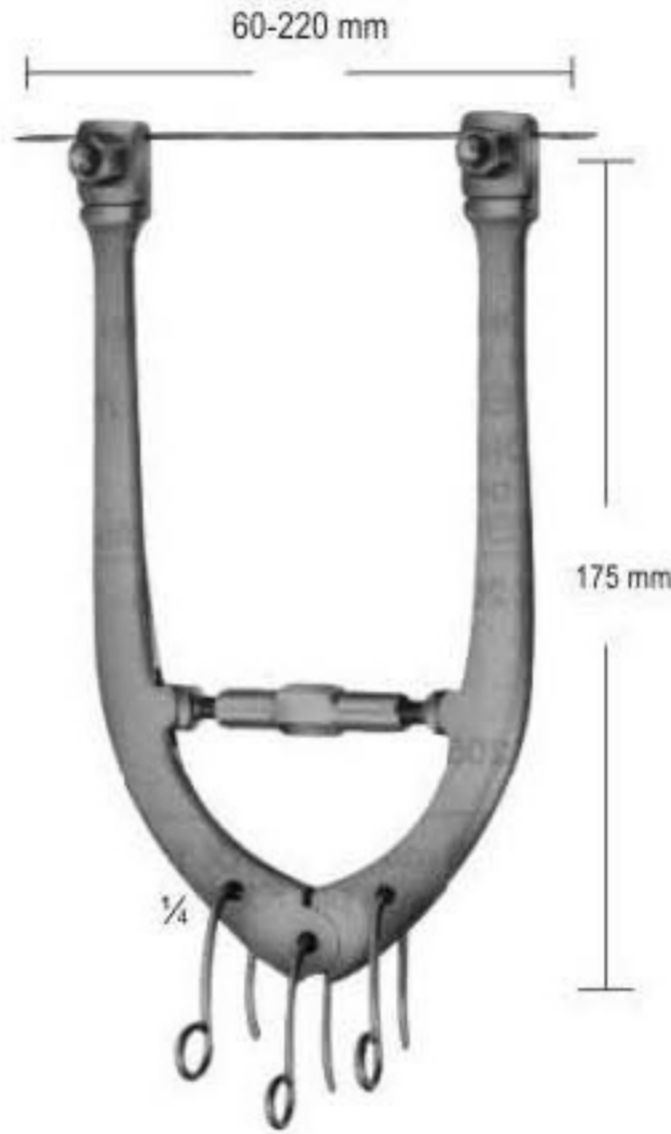

17-1773
Wire traction bow, adjustable,
with 3 hooks, large size

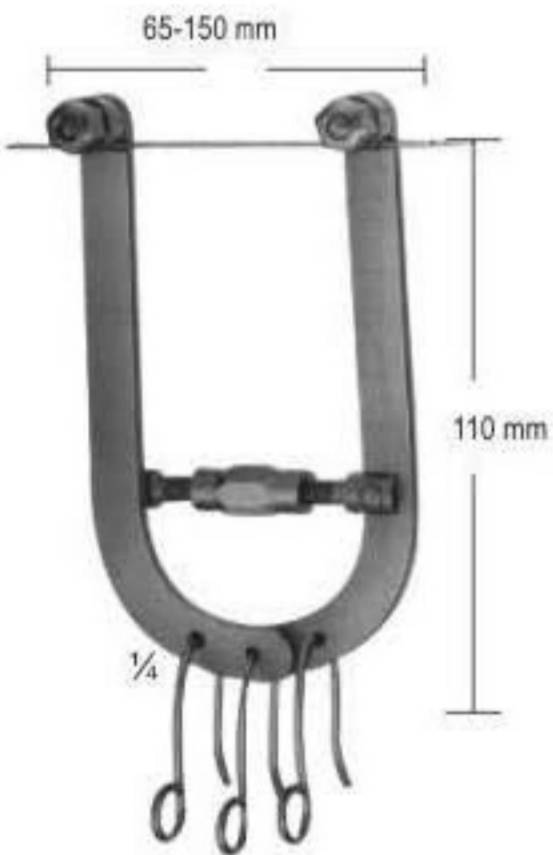

17-1774
Wire traction bow, adjustable,
with 3 hooks, large size for
elbow and calcaneus, for
adolescents



KIRSCHNER
17-1776 - 17-1781
Wire traction bow, modified
adjustable in with width, holds wire
securely, with 1 hook

- 17-1776** 10 cm
- 17-1777** 16 cm
- 17-1778** 20 cm

- 17-1779** 1.6 mm
- 17-1780** 2 mm
- 17-1781** 2.5 mm



17-1775
Fixation disc, slotted



17-1783
idem, aluminum, transparent
to X-rays



17-1782
Fixation disc, slotted



17-1784
Screw driver, for above
fixations discs

Traction Bows, Distractor



Steinmann pins, 4 mm daim.	Steinmann pins, 5 mm daim.
17-1785 with pin	16x9cm Arm
17-1786 without pin	17-1787 without
17-1788 with pin	21x11cm Arm
17-1789 without pin	17-1790 without
17-1791 with pin	21x15cm Arm
17-1792 without pin	

17-1785 - 17-1792
Screw driver, for above fixations discs



17-1793
SCHWARZ
Traction bow for fingers,
to be used with KIRSCHNER-
wire up to 1.6 mm diam.



17-1794
Small distractor
as a repositioning device for
distraction and compression of small bones,
for wires with 3 mm diam.

STEINMANN Pins



STEINMANN
17-1795 - 17-1809
triangular shaft ended
and trocar point

Length	4 mm	5 mm
8 cm	17-1795	
10 cm	17-1796	
12 cm	17-1797	
14 cm	17-1798	
15 cm	17-1799	17-1800
16 cm	17-1801	
18 cm	17-1802	17-1803
20 cm	17-1804	17-1805
21 cm	17-1806	
25 cm	17-1807	17-1808
30 cm		17-1809



17-1810
Protection cap
for 4 mm STEINMANN Pins



17-1811
Protection cap
for 5 mm STEINMANN Pins

Meniscus Knives



17-1812



17-1813



17-1814

17-1812 - 17-1814
17.5 cm



Fig. 1
17-1816

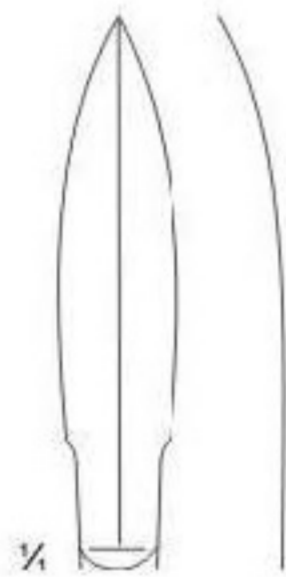

Fig. 2
17-1817



17-1815
17.5 cm



NEFF
17-1816 - 17-1817
22 cm



SALENIUS
17-1818
21.5 cm



SALENIUS
17-1819
21.5 cm

Meniscus Knives

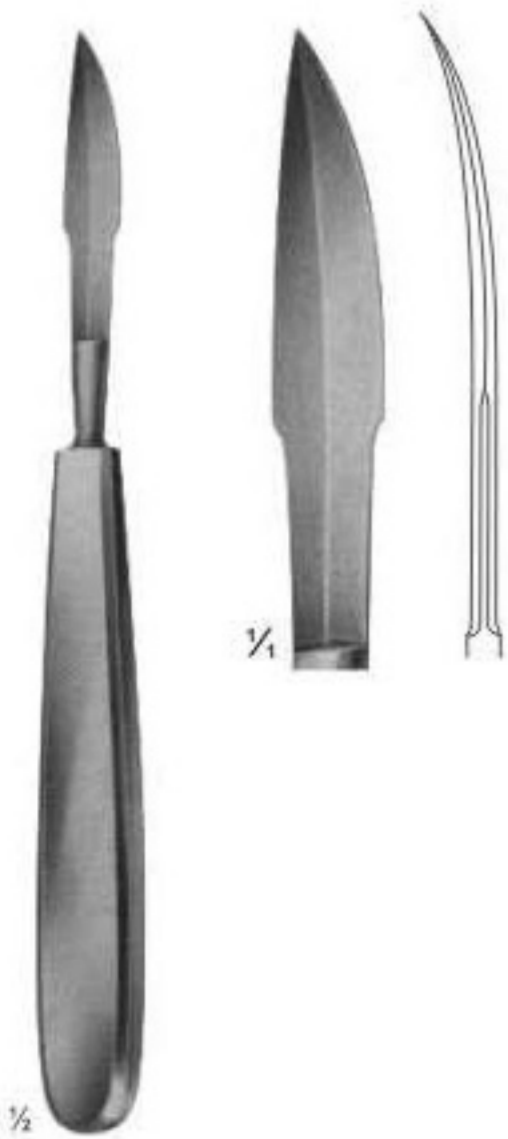

17-1820
17 cm



NEFF
17-1821
21.5 mm



NEFF
17-1822
21.5 cm



WAGNER
17-1823
21.5 cm

Meniscus Knives

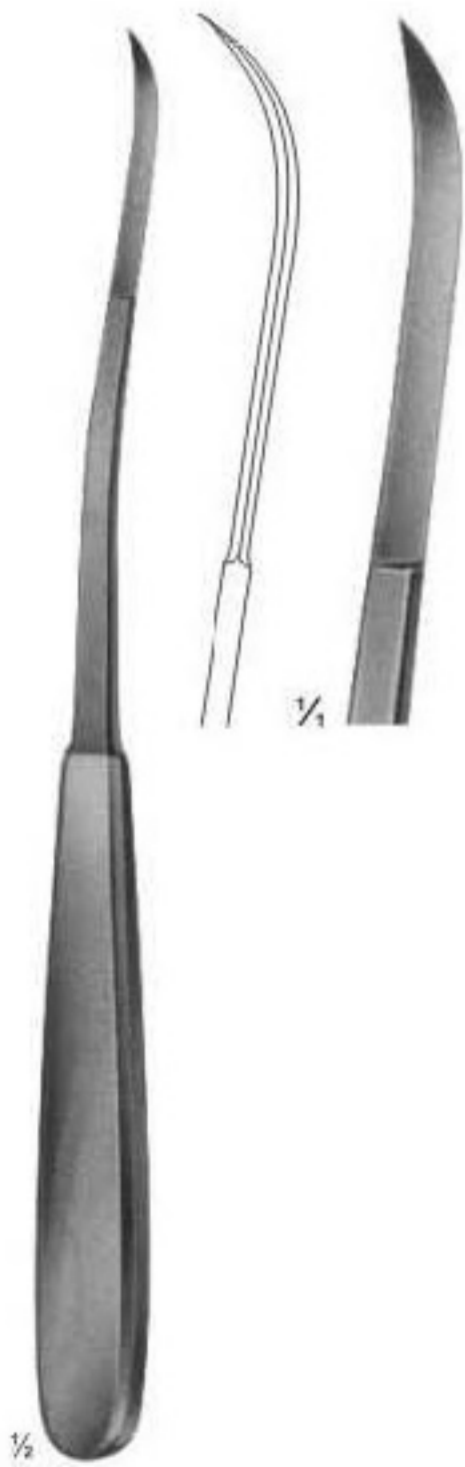

SALENIUS
17-1824
22 cm



CHNAD.MODELL
17-1825
20 cm

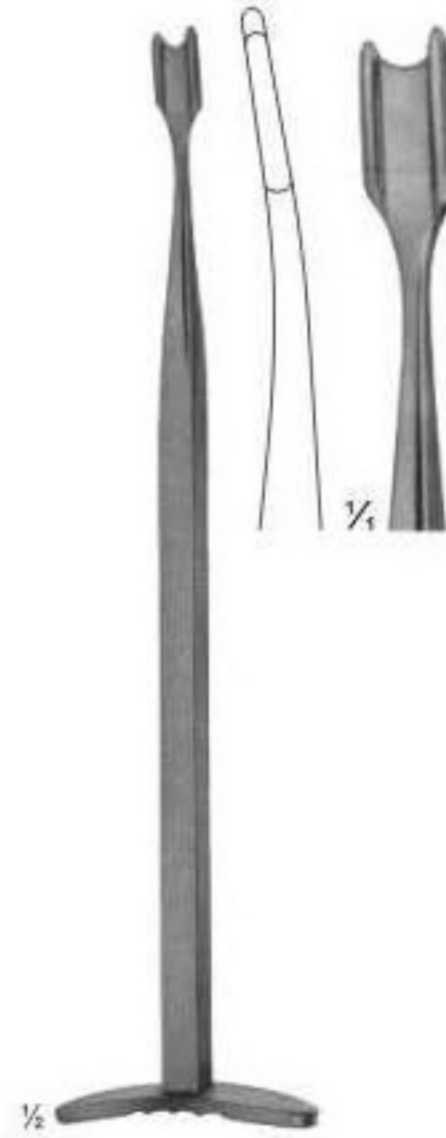

SMILLIE
17-1826
17 cm

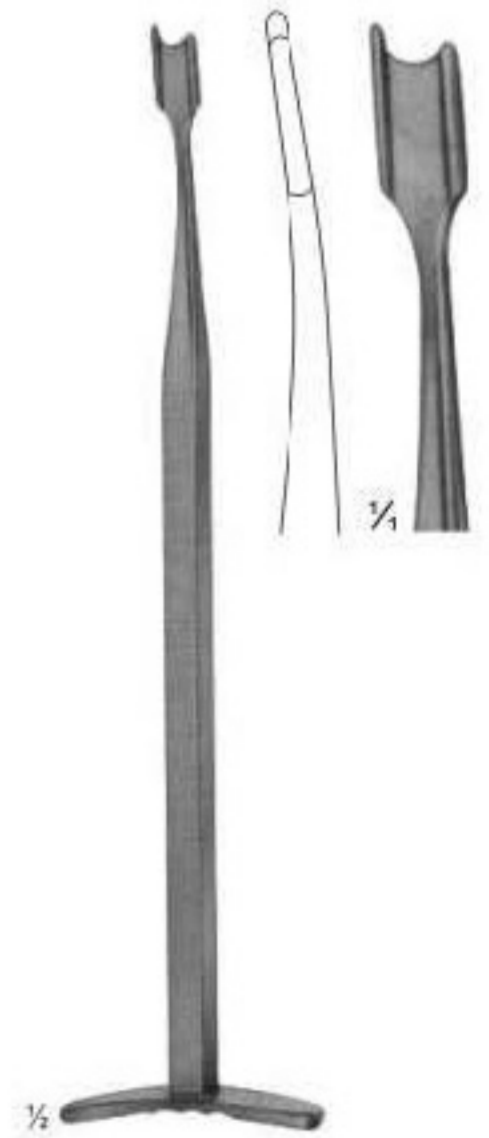

SMILLIE
17-1827
17 cm

Finger Nail Instruments

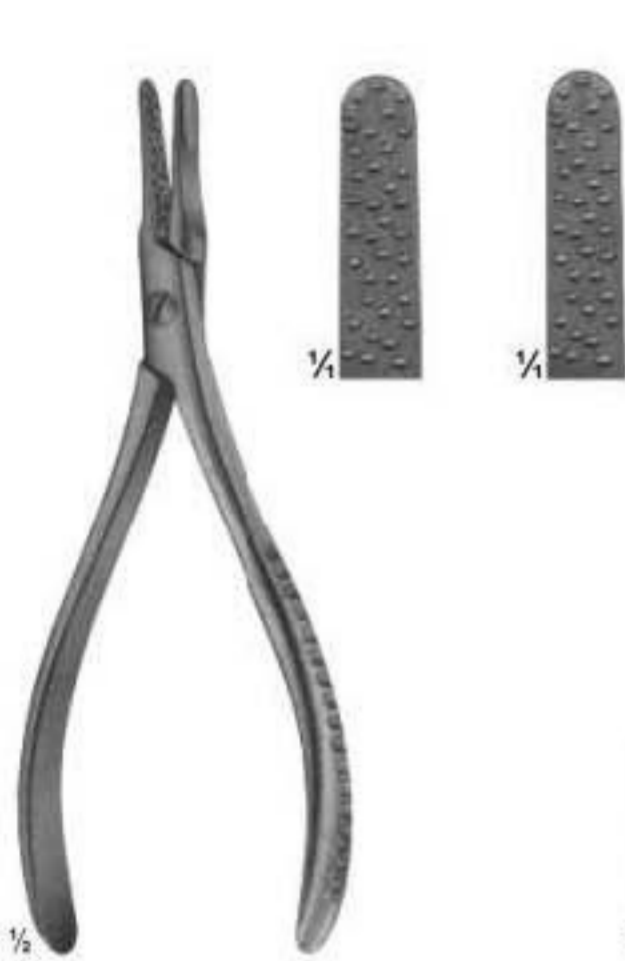

17-1828
Nail extracting
forceps
13.5 cm



17-1829
Nail extracting
forceps
14.5 cm



MARTIN-IDEAL
17-1830 - 17-1832
Finger nail drill
with 3 points

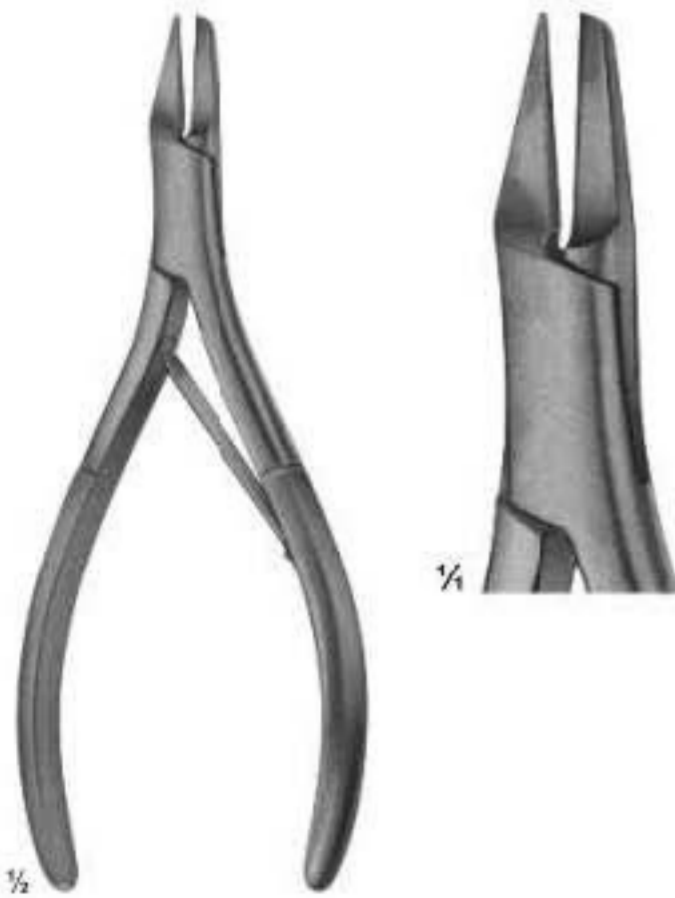

17-1833
Nail splitting
forceps
13.5 cm



SYSTRUNK
17-1834
Scissors, for splitting
finger nails
13 cm



17-1835
Finger ring saw
15 cm

Amputation Retractors

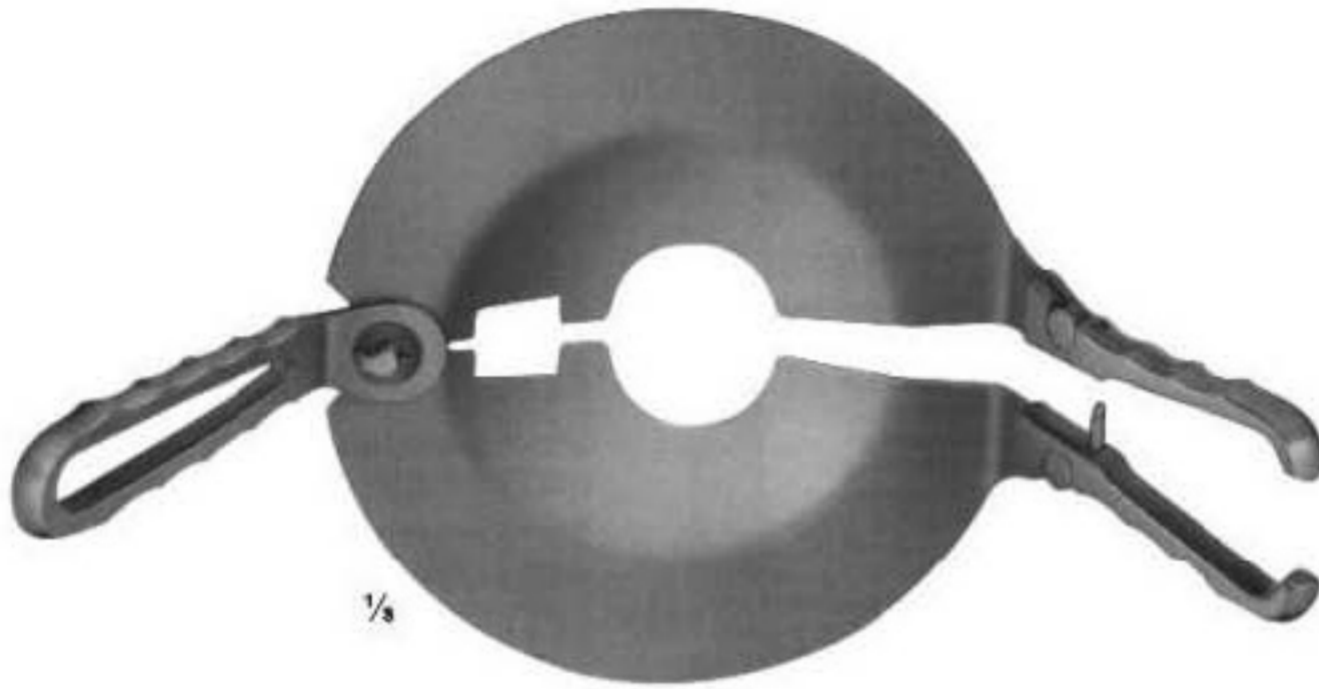

PERCY
17-1836
removeable handles

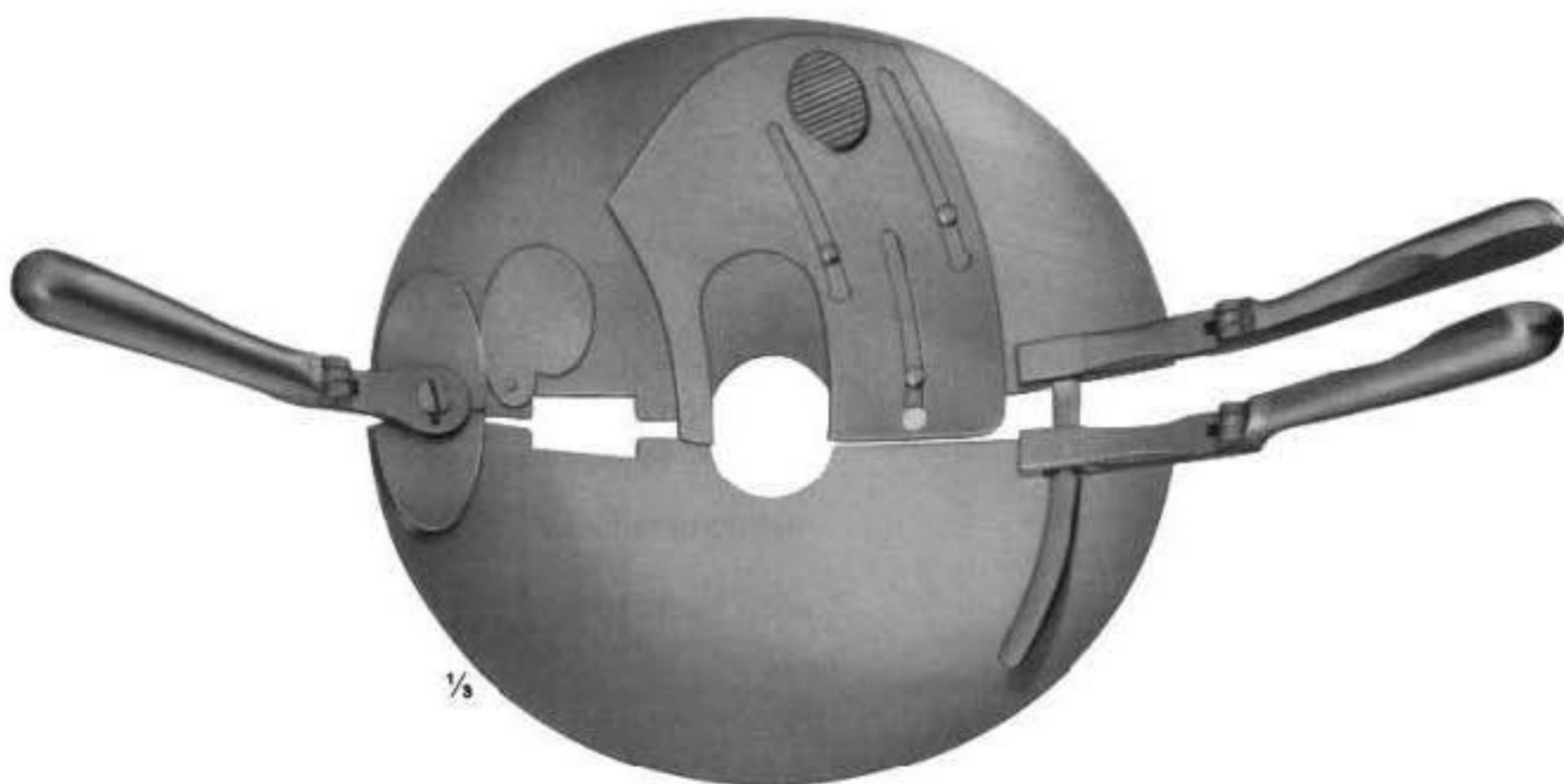

PERCY
17-1837
reversible handles

Wire Cutters And Wire Cutting Scissors

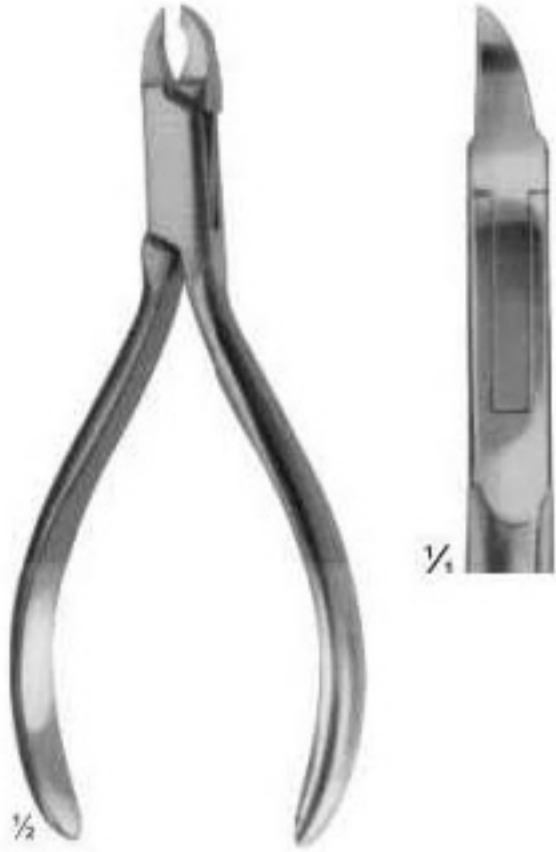

ANGLE
17-1838
13 cm

DUROTIP
ANGLE
17-1839
13 cm

for soft wire up to diam. 0.5 mm 0.6 mm
for hard wire up to diam. 0.3 mm 0.4 mm

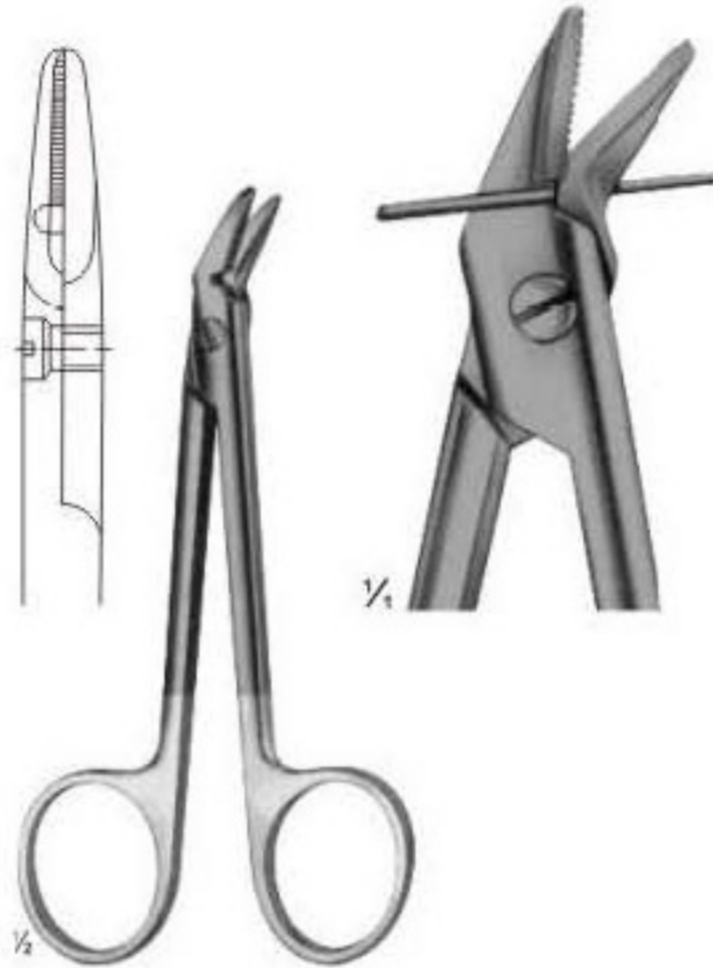

17-1840
12 cm

DUROTIP
17-1841
12 cm

for soft wire up to diam. 1.2 mm 1.2 mm
for hard wire up to diam. 0.8 mm 0.8 mm

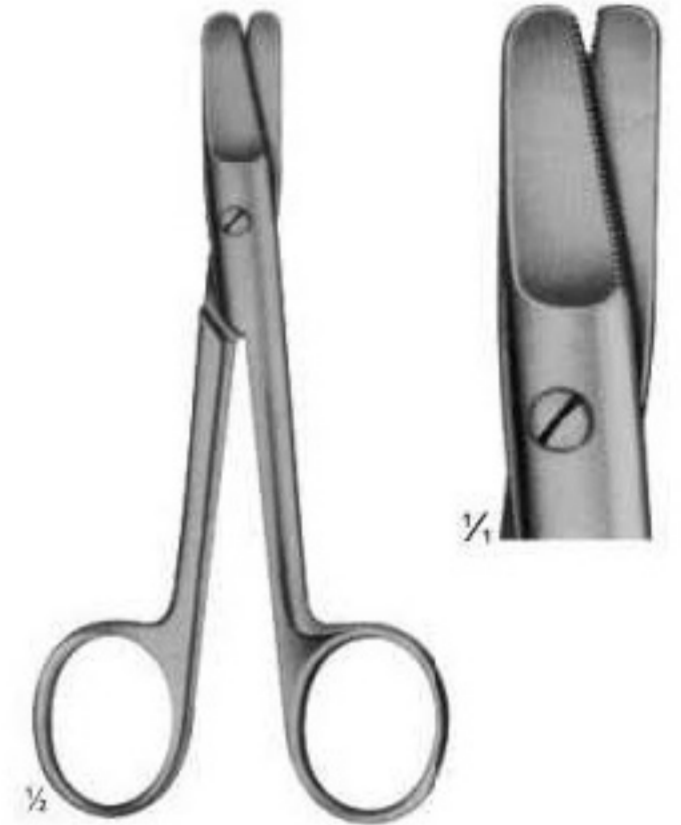

HARVEY
17-1842
12.5 cm

0.4 mm
0.3 mm



17-1843
15 cm

for soft wire up to diam 1.5 mm
for hard wire up to diam 1 mm



17-1844
16 cm

1.5 mm
1 mm



17-1845
14 cm

1.5 mm
1 mm

Wire Holding Forceps, Wire Tightening Pliers, Flat-nosed Pliers



**DUROGRIP
17-1846**
Holding forceps for cerclage
wire, with lateral jaws to avoid
wire slipping off
17 cm



**DUROGRIP
17-1847**
Wire, tightening pliers,
Ligature pliers
15 cm



**DUROGRIP
17-1848**
Wire, tightening pliers,
Ligature pliers
15 cm



17-1849
with serrated jaws
14 cm



17-1850
one jaws smooth,
one jaws serrated
14 cm



17-1851
with serrated jaws
17-1852
with longitudinal and
transversal grooves
17 cm



17-1853
19 cm

Page 498-553

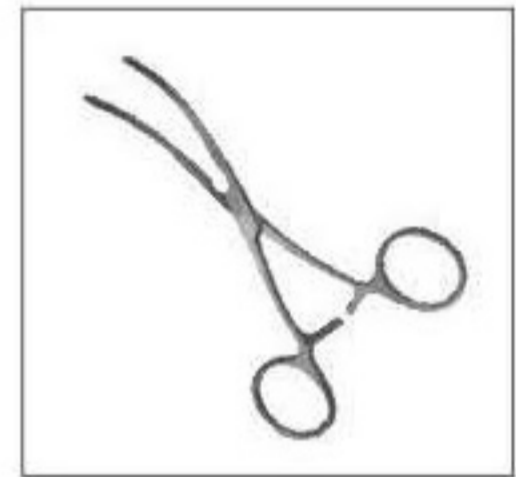

- Rib Shears
- Rib Spreaders & Contractors
- Rib Retractors
- Multi-purpose Vascular Clamps
- Lung Grasping Forceps
- Muller Vessel Clips
- Non-traumatic Haemostatic Forceps
- Ring Handle Bulldog Clamps
- Anastomosis & Multi-purpose-Clamps For Neonates
- Anastomosis & Multi-purpose-Clamps-Paediatric Types
- Vena-cava Clamps
- Anastomosis & Aneurysm Clamps
- Aorta-anastomosis Clamps
- Forceps For Vena-cava
- Auricle Clamps
- Perfunda & Peripheral Vascular Clamps
- Catheter Clamps
- Aortic Clamps
- Aneurysm Clamps
- Biopotome & Aortic Dilators
- Vascular Dilators
- Intima Spatulas

- Nerve Hooklets, Tourniquets



Rib Shears



KILLIAN
18-1001
20 cm



18-1002 - 18-1003
18-1002 19.5 cm
18-1003 22.5 cm



LEBSCHE
18-1004
Sternum chisel
20 cm



18-1005
23 cm



COLLIN
18-1006
19.5 cm



GLUCK
18-1007
19 cm

Rib Shears



1/2
SCHUMACHER
Sternum shears
18-1008
21 cm



1/3
GIERTZ-STILLE
18-1009
25 cm



1/2
GLUCK
18-1010
19 cm



1/3
BRUNNER
Universal Pattern
18-1011
34 cm

Rib Spreaders

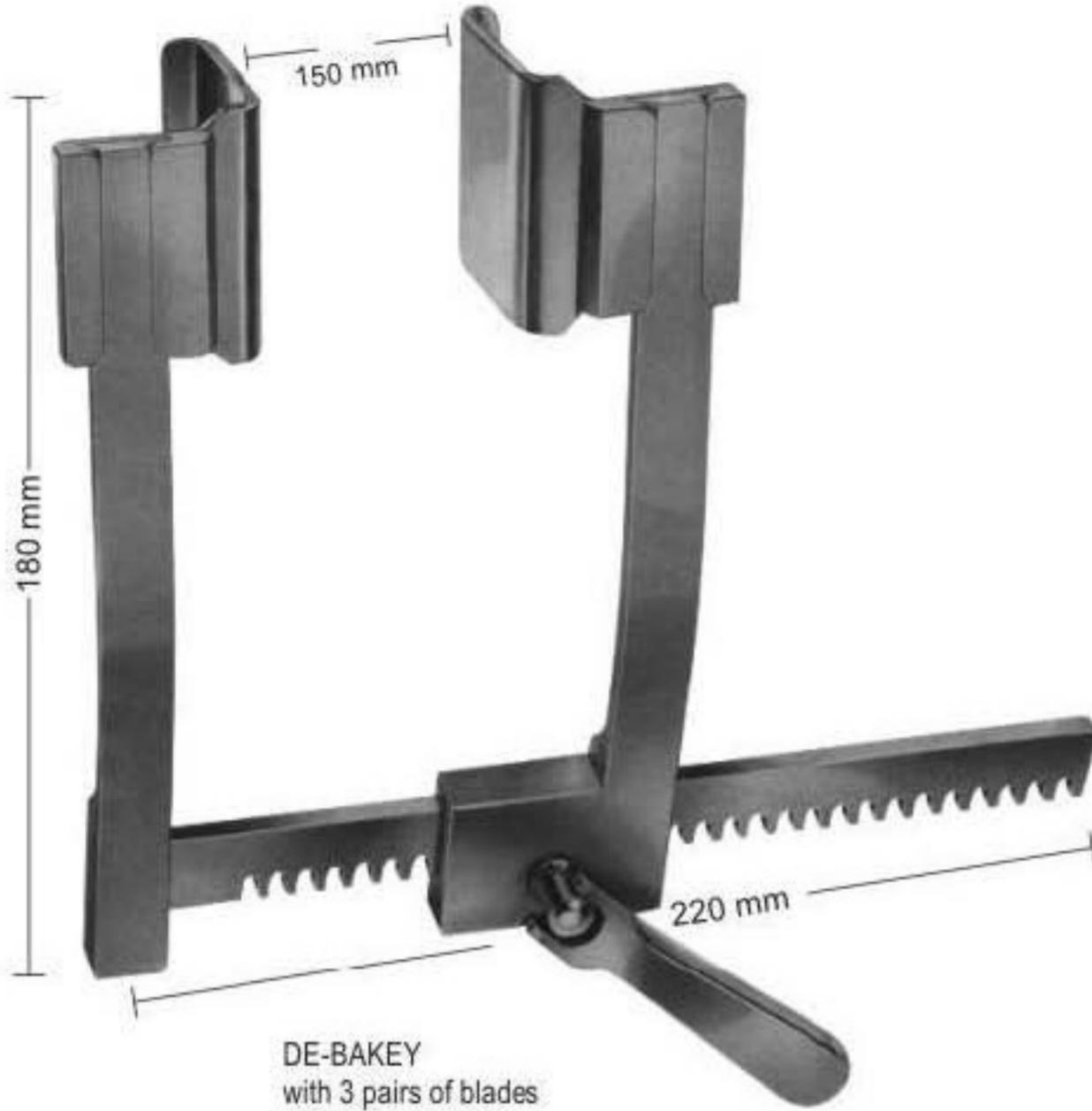

DE-BAKEY
with 3 pairs of blades
18-1012 - 18-1014

STAINLESS STEEL



STAINLESS STEEL

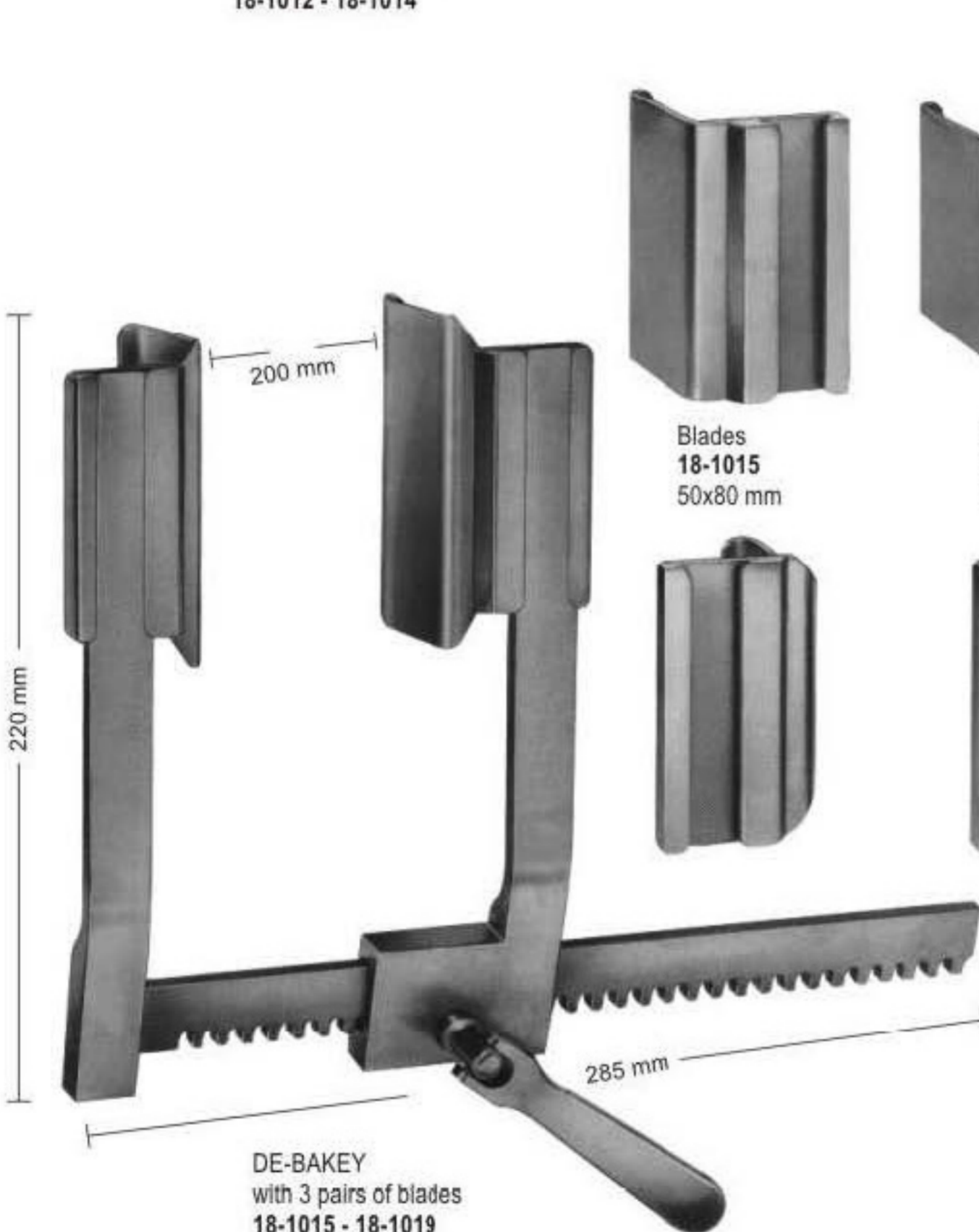

DE-BAKEY
with 3 pairs of blades
18-1015 - 18-1019



Sternotomy Blades
18-1019
50x660 mm



Rib Retractors

STAINLESS STEEL



18-1020 - 18-1021
for blades, with 2 pairs of blades
9X20 mm 9X10 mm, spreading 52 mm



18-1020
Blades, only
9x20 mm



18-1021
Blades, only
9x10 mm

ALUMINIUM



COOLEY
18-1022
for blades, lateral blades 12X16 mm,
spreading 95 mm

ALUMINIUM

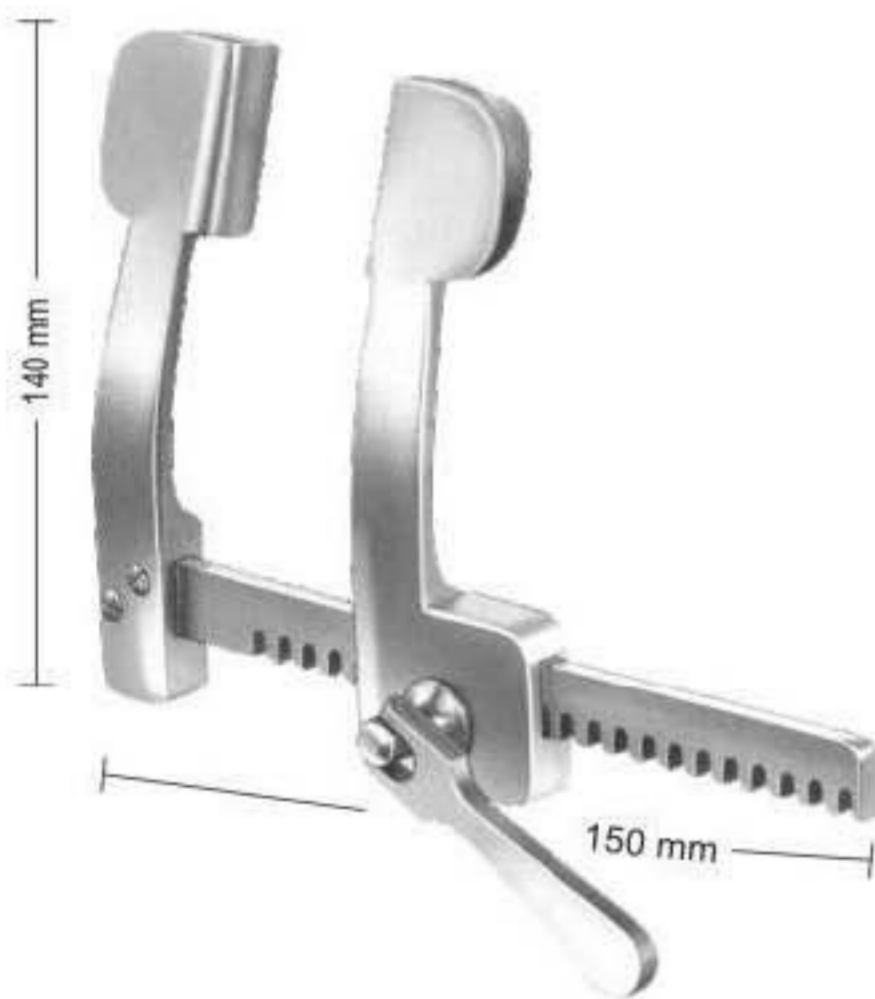

COOLEY
18-1023
for children, lateral blades 21X44 mm,
spreading 150 mm

ALUMINIUM

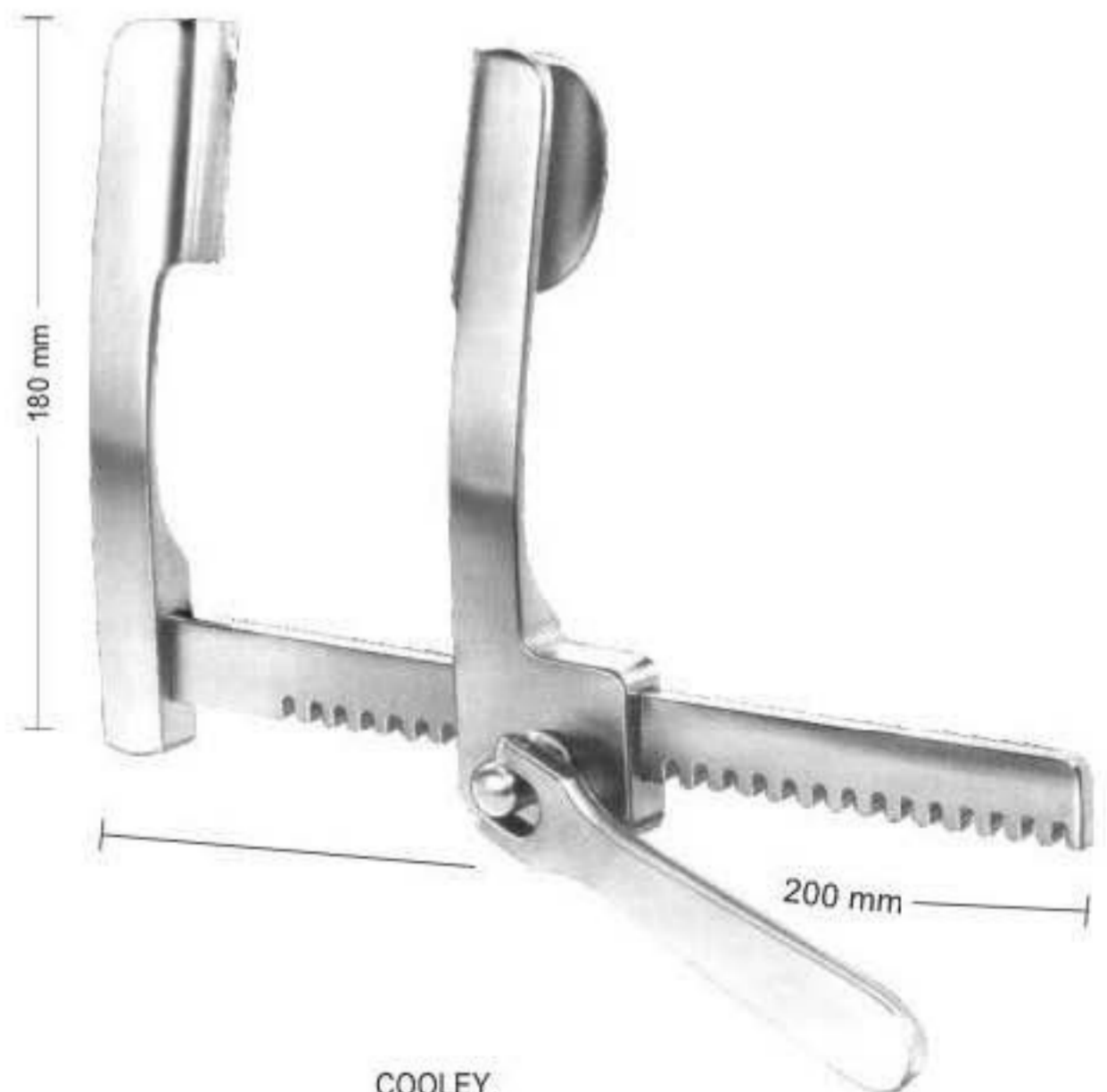

COOLEY
18-1024
for adults, lateral blades 35X50 mm,
spreading 200 mm

Rib Retractors

ALUMINIUM

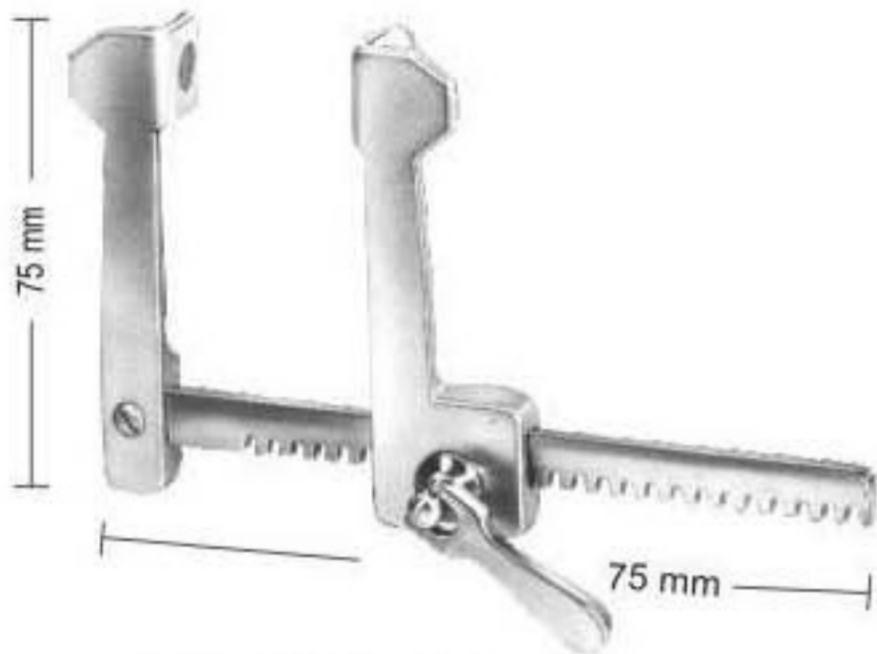

FINOCHIETTO, INFANT
18-1025
for children, lateral blades 15X15 mm,
spreading 75 mm

STAINLESS STEEL

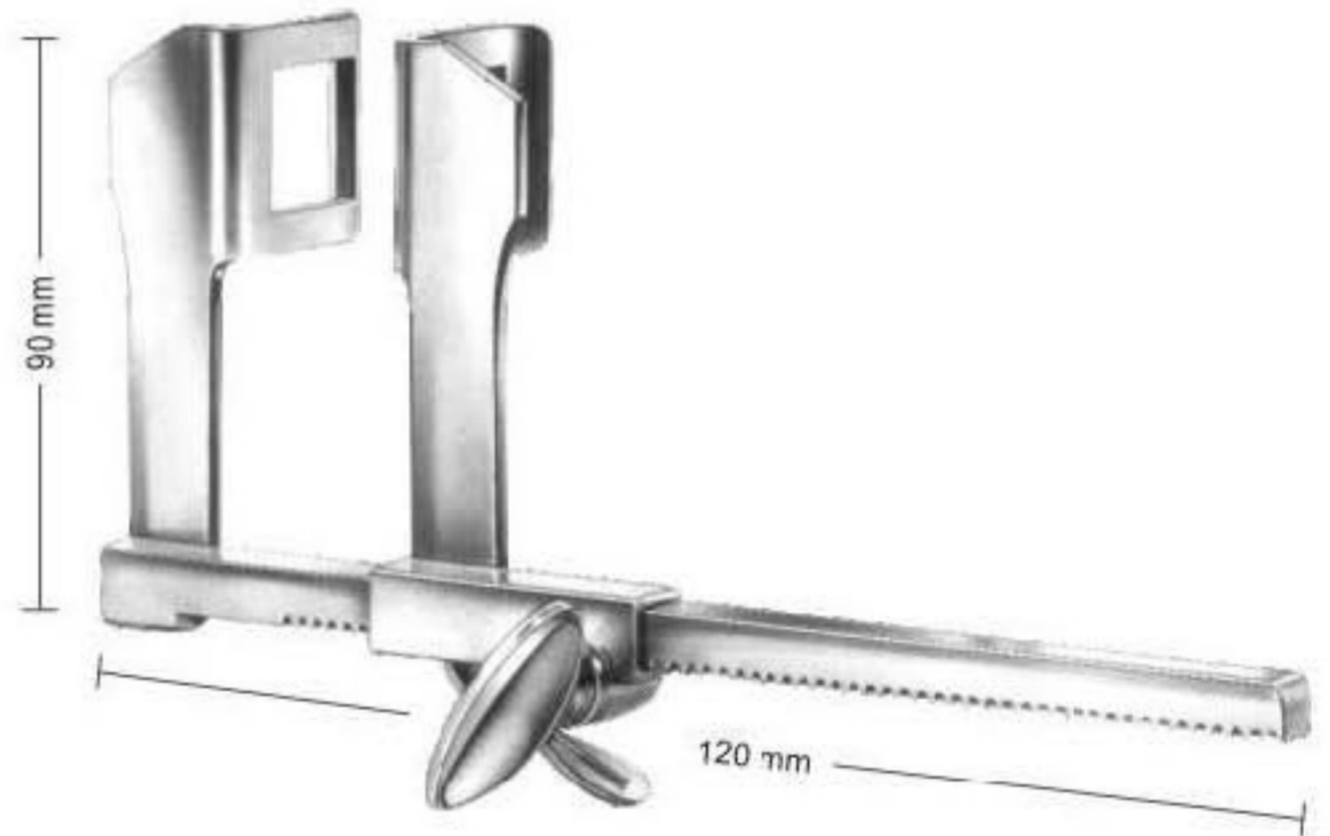

HAIGHT
18-1026
lateral blades 30X30 mm,
spreading 120 mm

ALUMINIUM

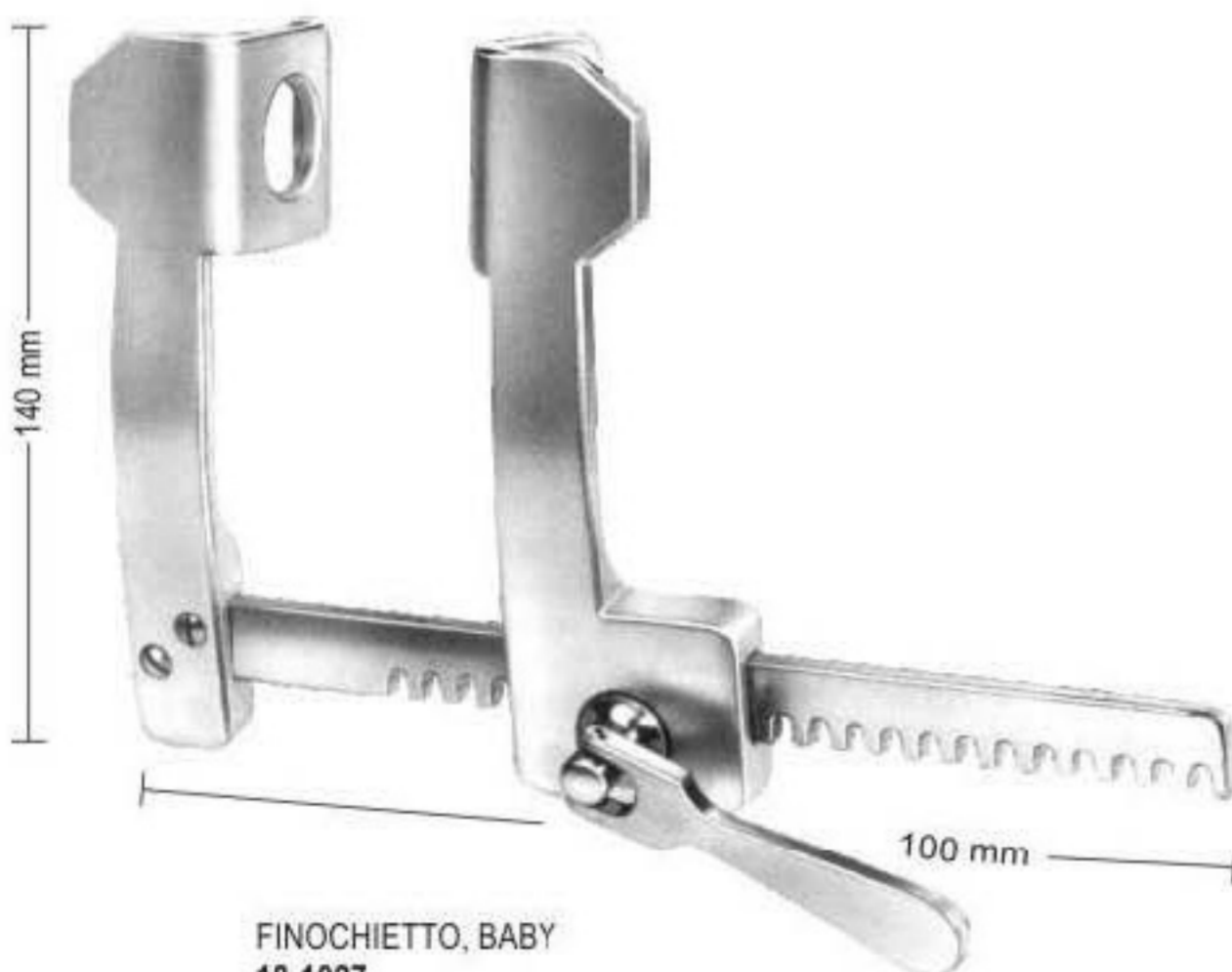

FINOCHIETTO, BABY
18-1027
for children, lateral blades 31X31 mm,
spreading 100 mm

Rib Retractors

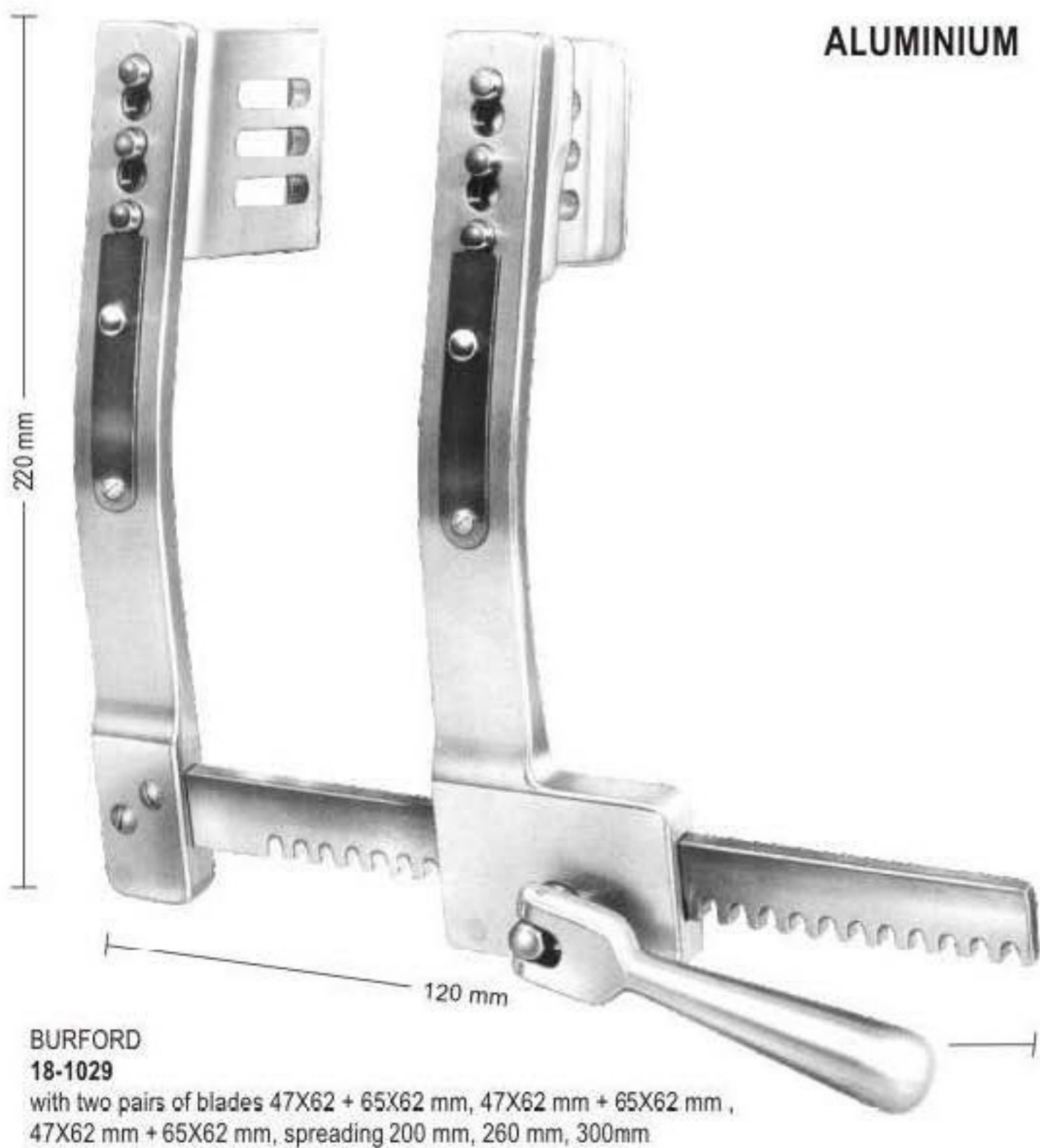
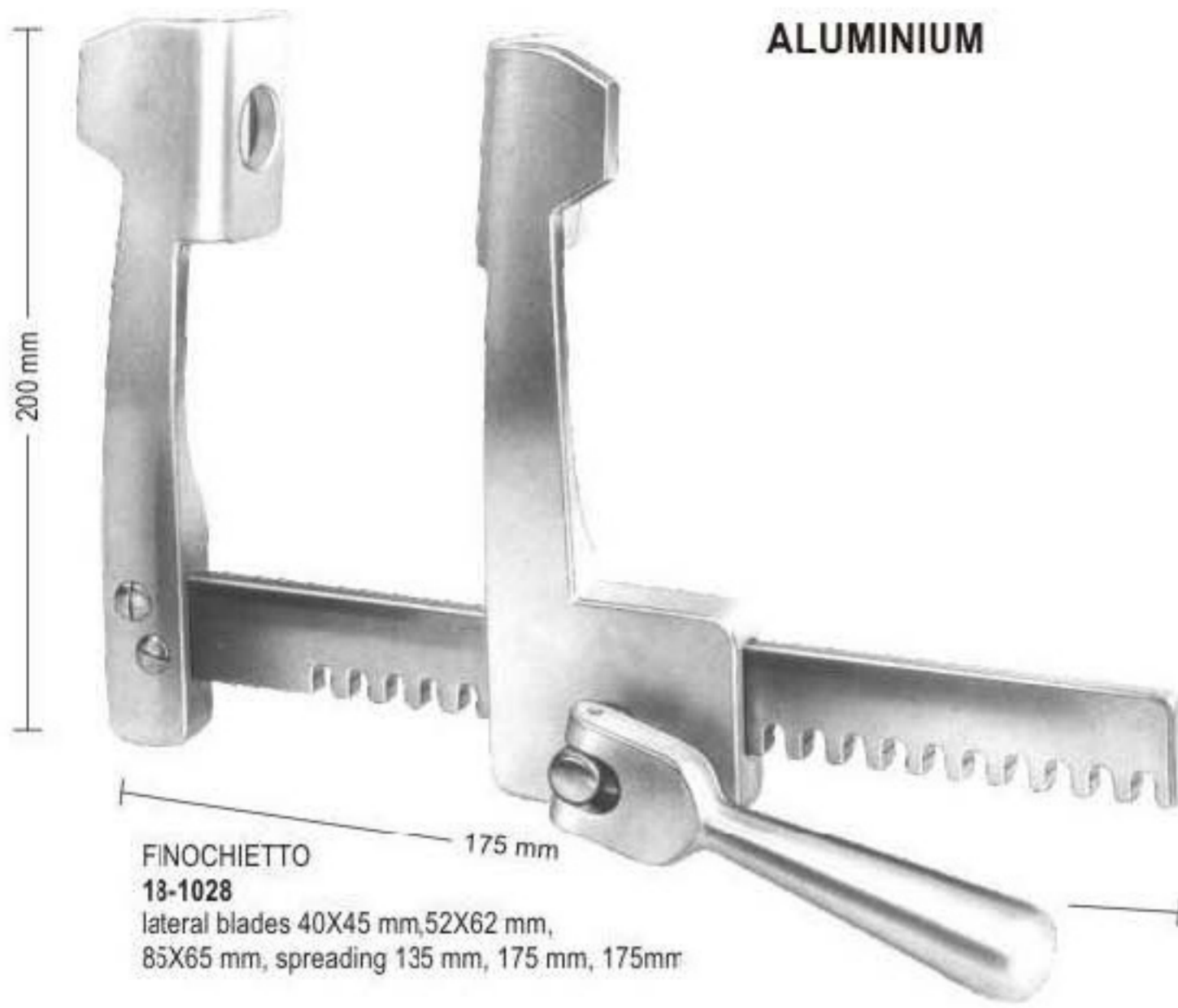

Rib Retractors



Rib Retractors

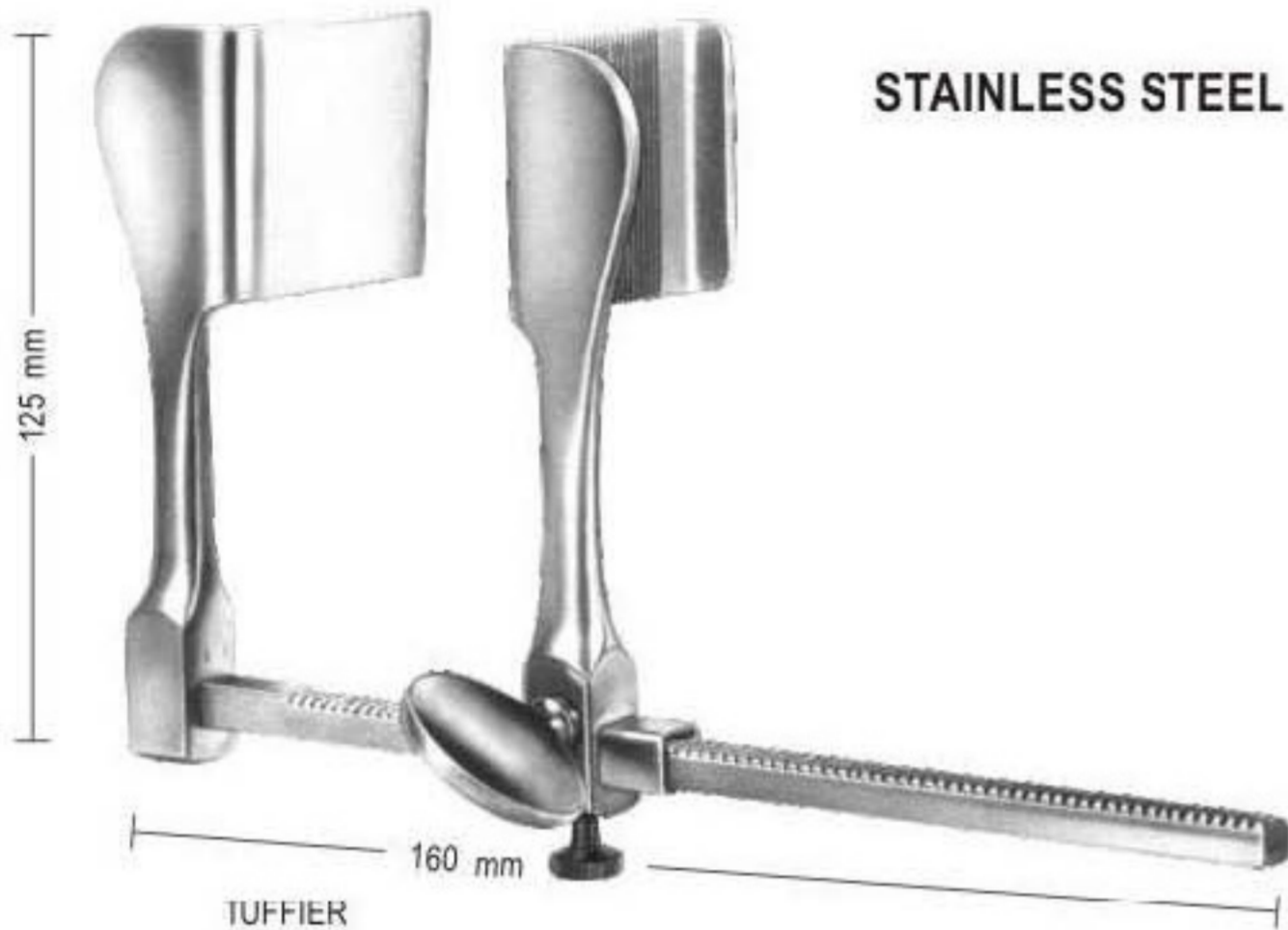

STAINLESS STEEL

TUFFIER
18-1032
lateral blades 45X45 mm,
spreading 160 mm

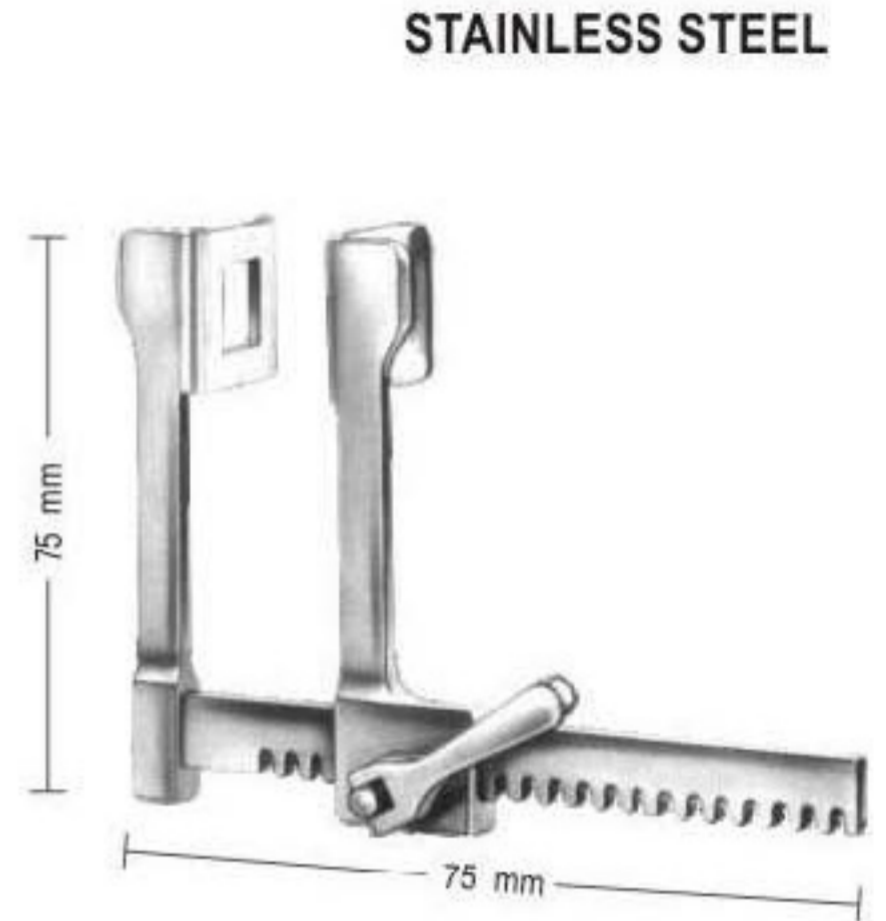

STAINLESS STEEL

FINOCHIETTO, BABY
18-1033
lateral blades 14X15 mm,
spreading 75 mm



STAINLESS STEEL

FINOCHIETTO
18-1034
lateral blades 30X45 mm, 46X62 mm, 80X65 mm,
spreading 150 mm, 190 mm, 190 mm

Rib Spreaders-and Contractors



SELLORS
Rib spreader-and contractor
with swivel blades
18-1035
20 cm



BAILEY-BABY
18-1036
15 cm



BAILEY
18-1037
20 cm



BAILEY-GIBBON
18-1038
20 cm

Rib Spreaders-and Contractors



HARRINGTON RETRACTOR
18-1039
123X45 mm 29.5 cm
123X64 mm 29.5 cm
175X64 mm 29.5 cm



ALLISON
18-1040
40 mm 29.5 cm
54 mm 33 cm

Multi-purpose Clamps



PRICE THOMAS
18-1041
22.5 cm

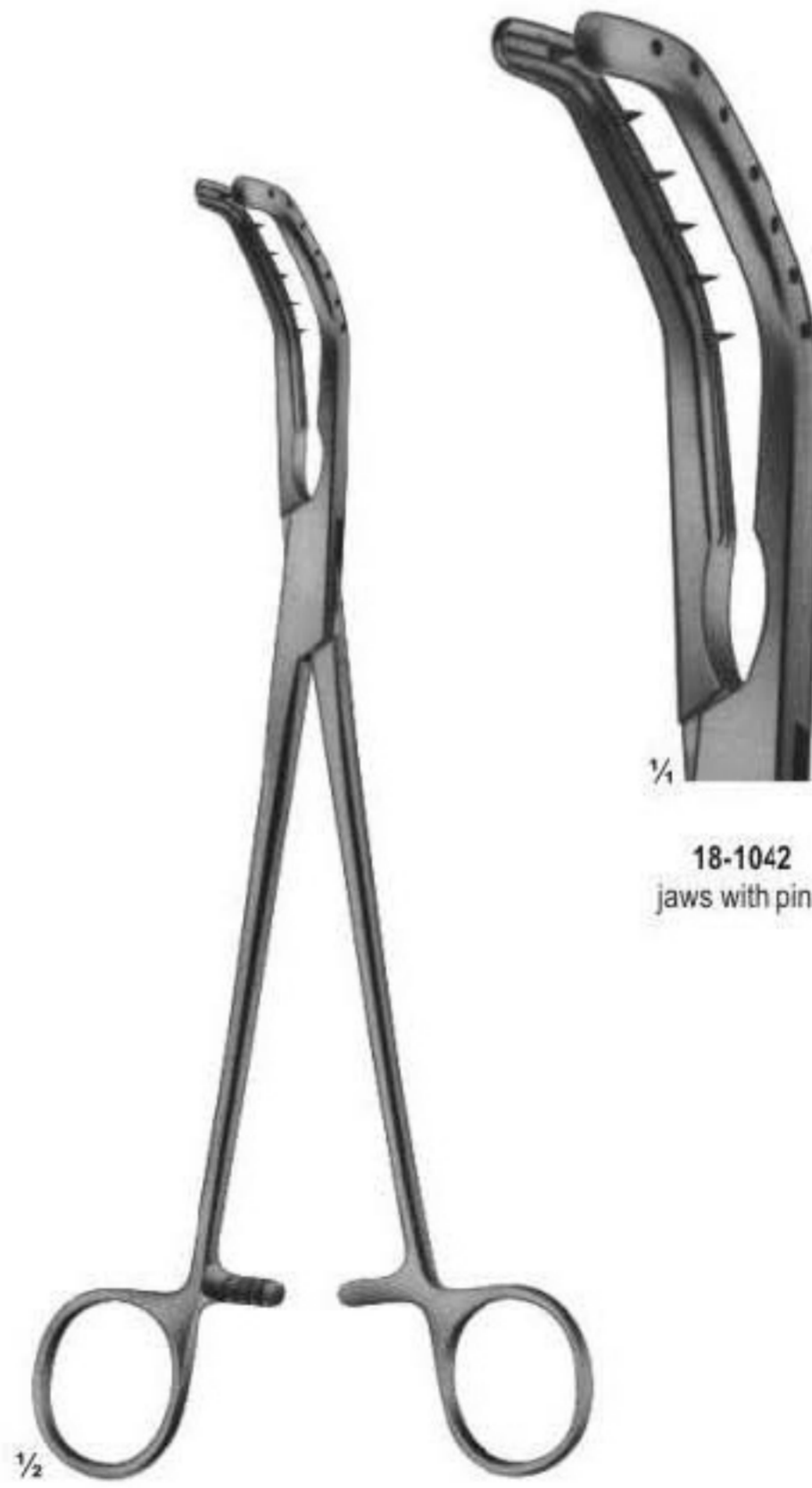

PRICE THOMAS
18-1042 - 18-1043
22.5 cm

18-1042
jaws with pins



18-1043
jaws with pins

Lung Grasping Forceps



LOVELACE
18-1044
20.5 cm

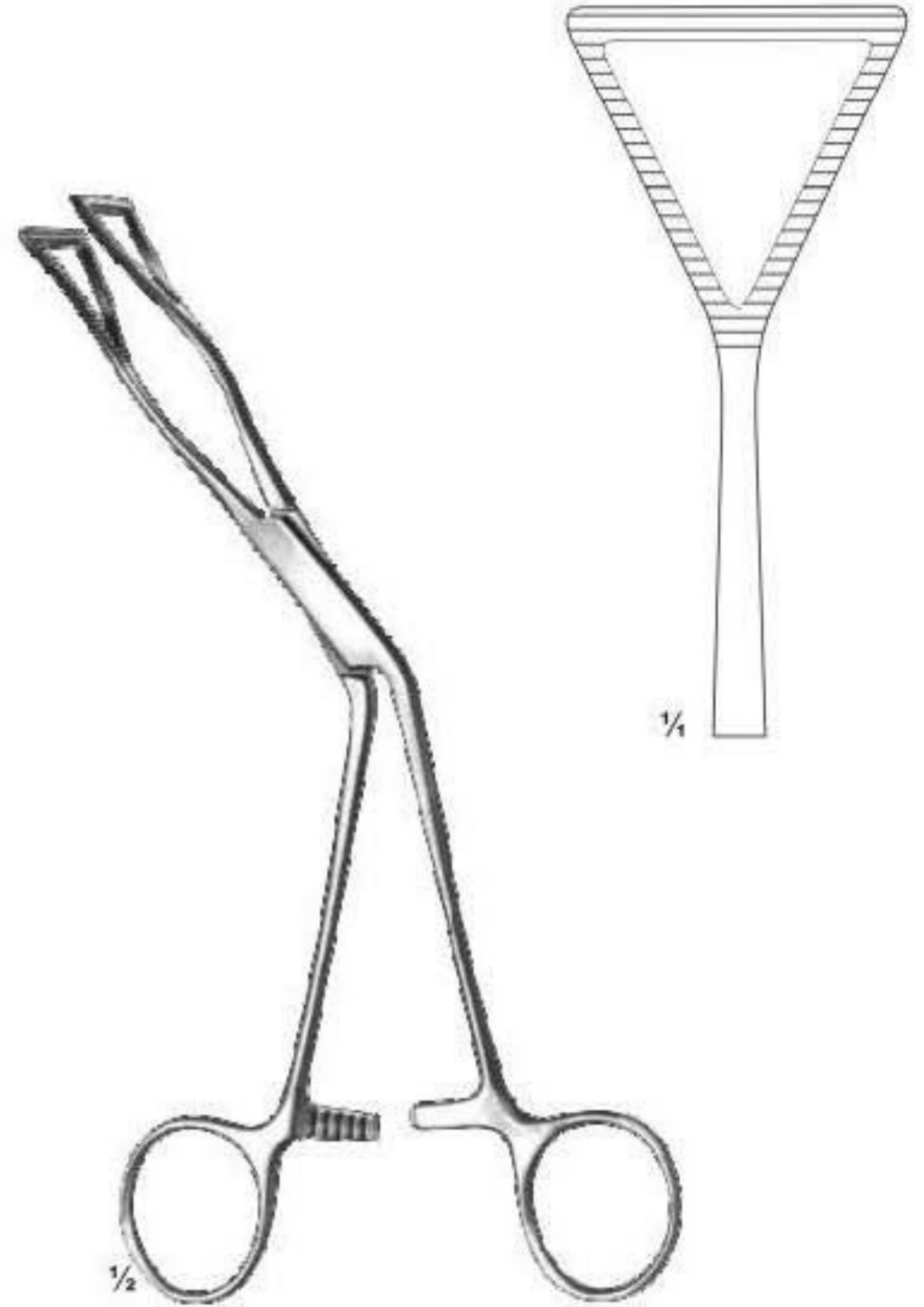

LOVELACE
18-1045
19 cm

Muller Vessel Clips And Bulldog Clamps

Closing Force



18-1046
Straight
80g
50g



18-1047
Curved
80g
50g



18-1048
Curved tips
80g
50g



18-1049
Angled
Shaped
80g
50g



18-1050
Muller
Knee-bent
80g
50g



18-1051
Muller
Ligature Forceps

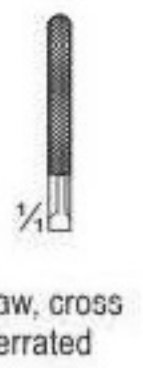

18-1052
35 mm



18-1053
35 mm



18-1054
45 mm



18-1055
45 mm



DIEFFENBACH

18-1056
38 mm



DIEFFENBACH

18-1058
38 mm



DIEFFENBACH

18-1060
58 mm



DIEFFENBACH

18-1061
58 mm



JOHNS-HOPKINS

18-1062 -18-1069
91 mm



**DE BAKEY-
HESS**
18-1070
20 mm

- 18-1062** 38 mm
- 18-1063** 48 mm
- 18-1064** 56 mm
- 18-1065** 63 mm
- 18-1066** 75 mm
- 18-1068** 80 mm
- 18-1069** 90 mm



DE BAKEY
18-1071
Length
50 mm
Jaws
27 mm



DE BAKEY
18-1072
Length
48 mm
Jaws
27 mm



GLOVER
18-1073
Length
57 mm
Jaws
35 mm



DE BAKEY
18-1074
Length 73 mm
Jaws 38 mm



DE BAKEY
18-1075
Length 99 mm
Jaws 63 mm



DE BAKEY
18-1076
Length 95 mm
Jaws 54 mm



DE BAKEY
18-1077
L. 80 mm



DE BAKEY
18-1081
L. 78 mm



GLOVER
18-1085
L. 68 mm



GLOVER
18-1088
L. 65 mm

Non-traumatic Haemostatic Forceps



MOSQUITO FORCEPS
18-1091 - 18-1092
12.5 cm



18-1091
20 mm



18-1092
20 mm



RANKIN
18-1093 - 18-1094
16.5 cm



18-1093
27 mm



18-1094
27 mm



DE BAKY-BAINRIDGE
18-1095 - 18-1096
15.5 cm



18-1095
40 mm



18-1096
40 mm



DE BAKY-BAINRIDGE
18-1097 - 18-1098
18.5 cm



18-1097
65 mm



18-1098
65 mm

Non-traumatic Haemostatic Forceps



DE-BAKEY-KELLY
18-1099 - 18-1100
14 cm



18-1099
32 mm



18-1100
32 mm



PEAN
18-1101 - 18-1102
15.5 cm



18-1101
50 mm



18-1102
50 mm



18-1103 - 18-1108

DE-BAKEY-PEAN	DE-BAKEY-PEAN
18-1103 20 cm	18-1106 20 cm
18-1104 26.5 cm	18-1107 26 cm
18-1105 28 cm	18-1108 27.5 cm



18-1103
60 mm



18-1104
89 mm



18-1105
99 mm



18-1106
60 mm



18-1107
89 mm



18-1108
99 mm

Ring Handle Bulldog Clamps

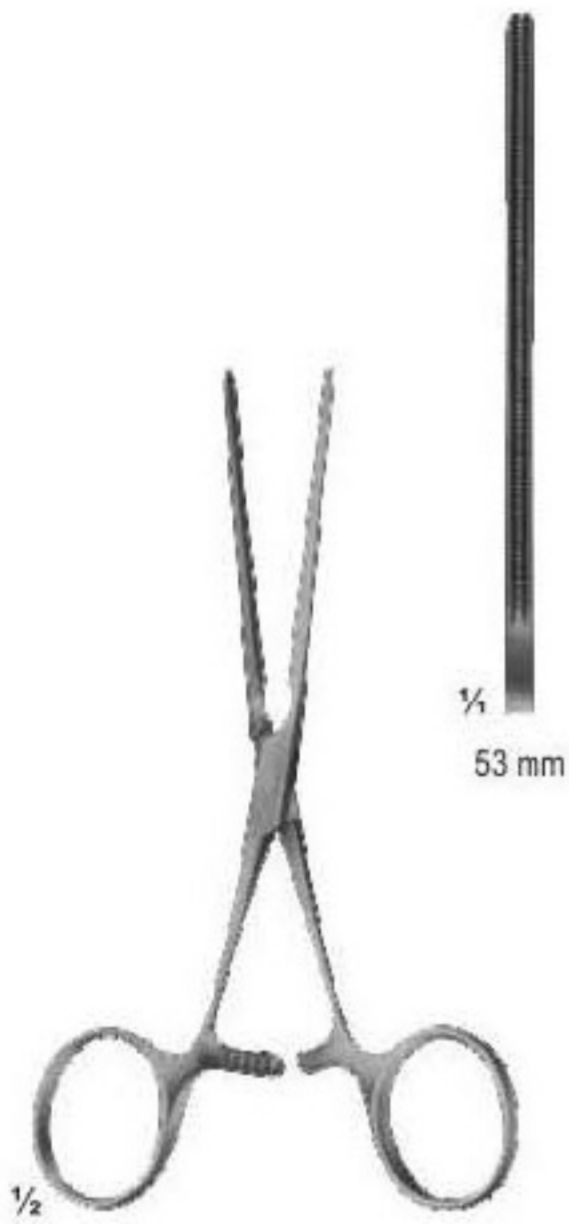

DE-BAKEY
gerade straight
18-1109
13 cm

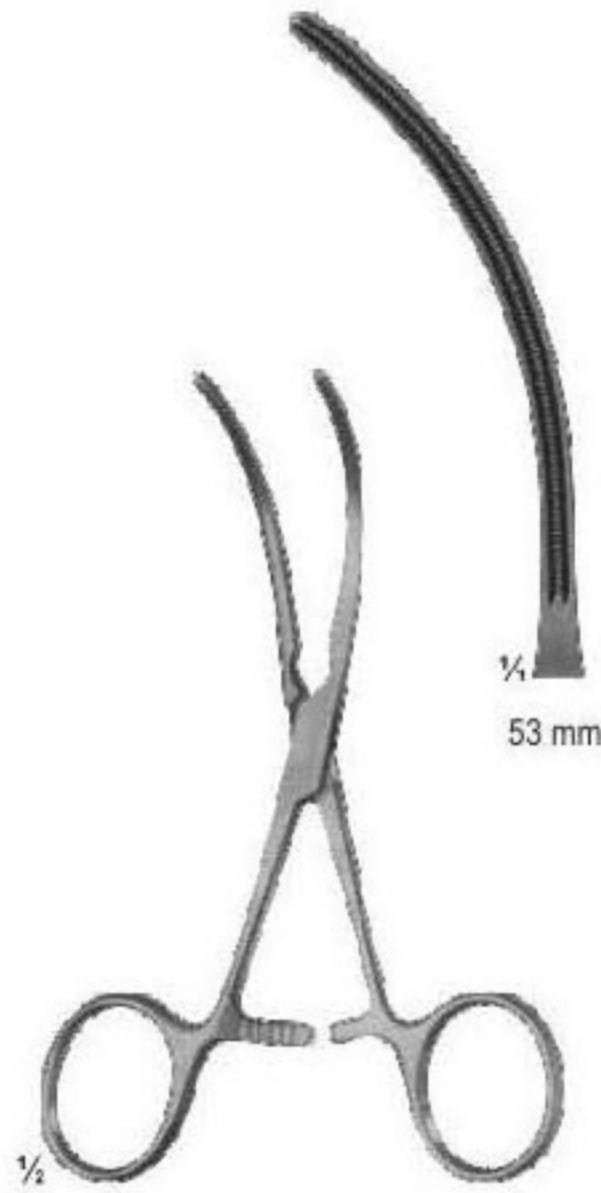

DE-BAKEY
curved jaws
18-1110
12.5 cm

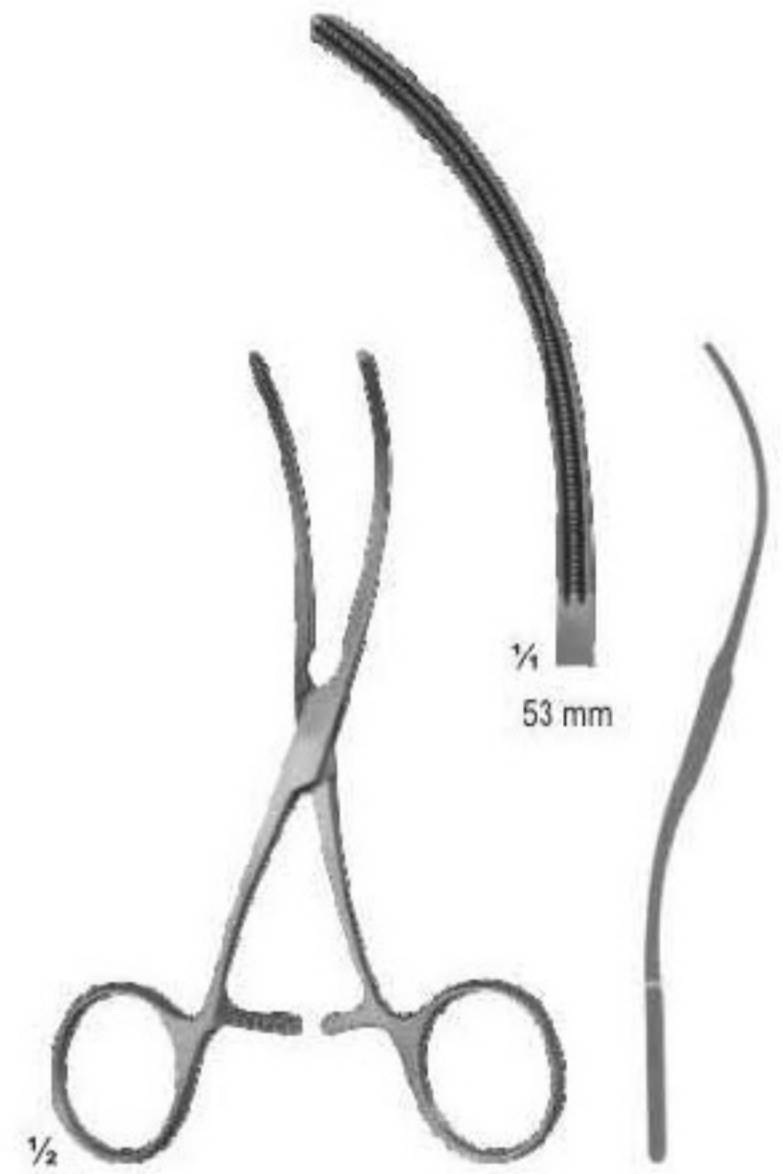

DE-BAKEY
S-shaped curved
18-1111
12.5 cm

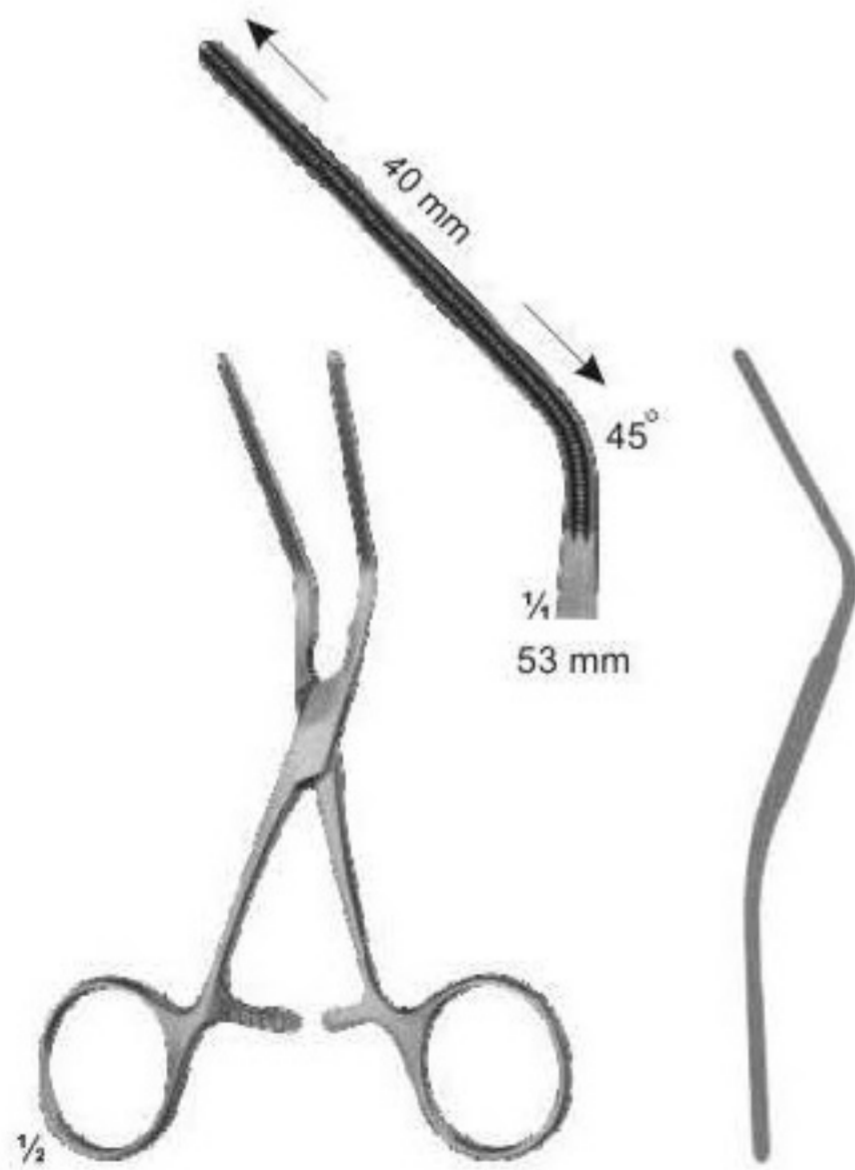

DE-BAKEY
angled 45°
18-1112
12.5 cm



DE-BAKEY
angled 90°
18-1113
10.5 cm

Anastomosis-and Multi-purpose-clamps For Neonates

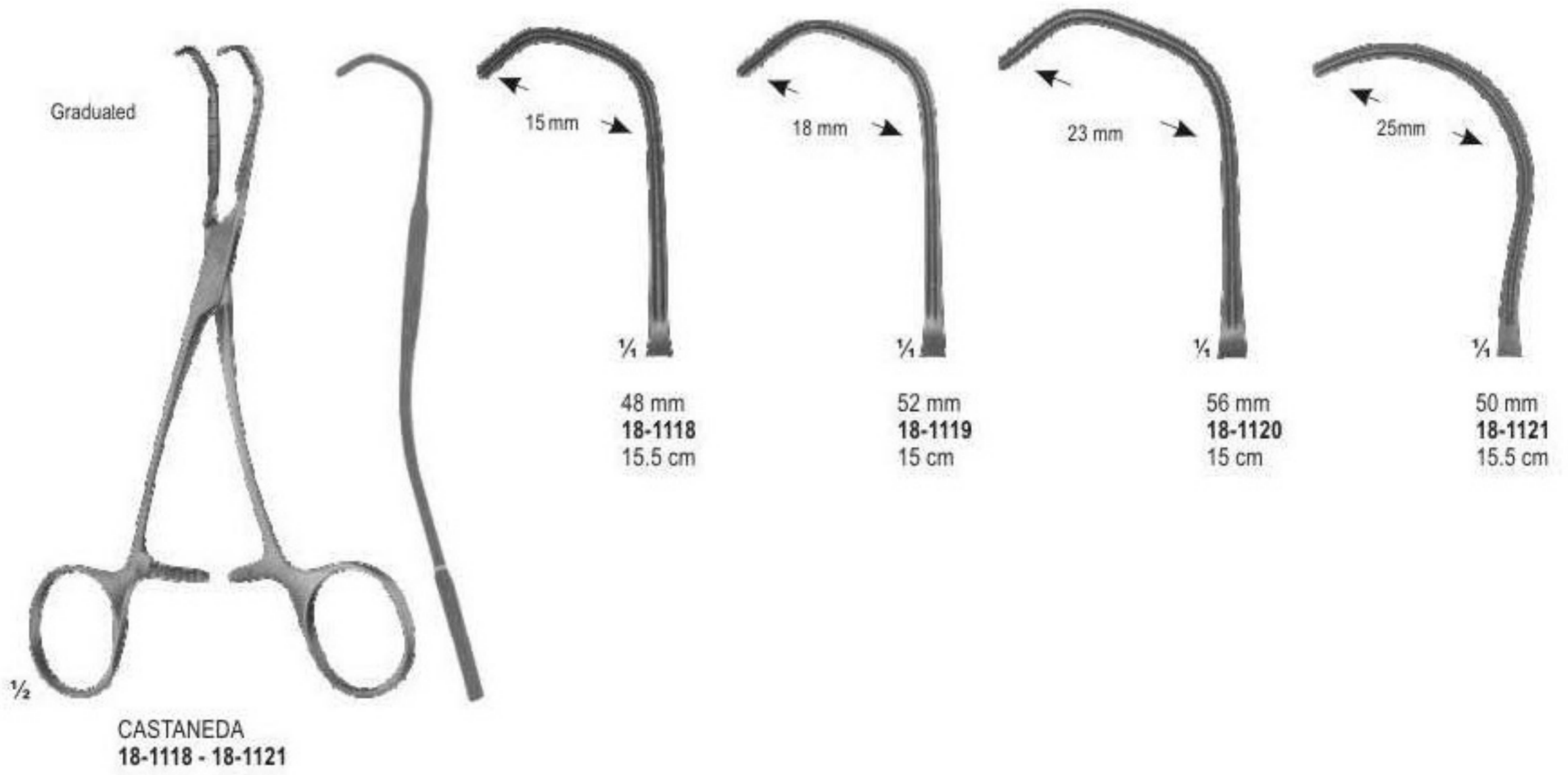
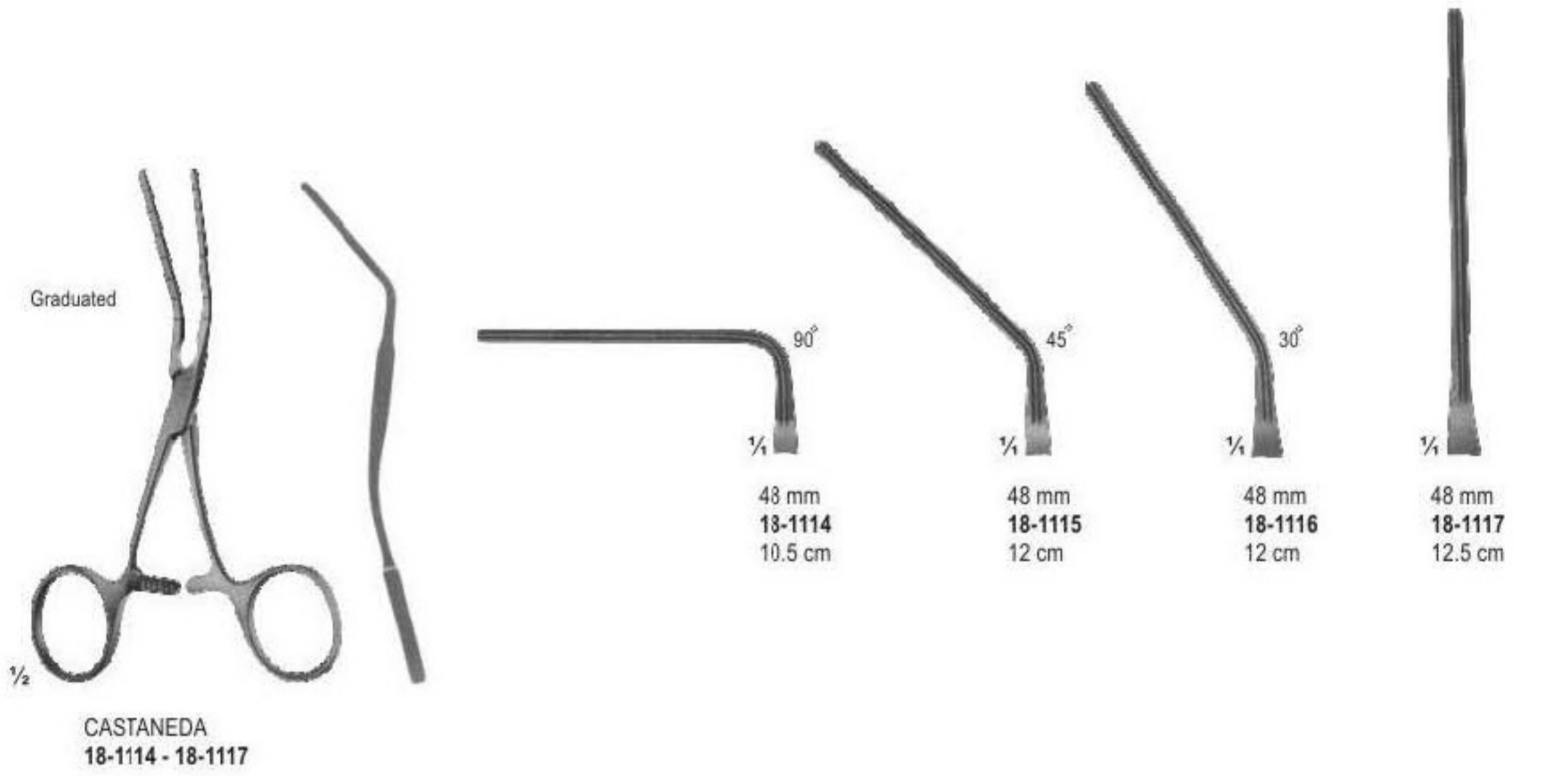

Anastomosis-and Multi-purpose-clamps-paediatic Types

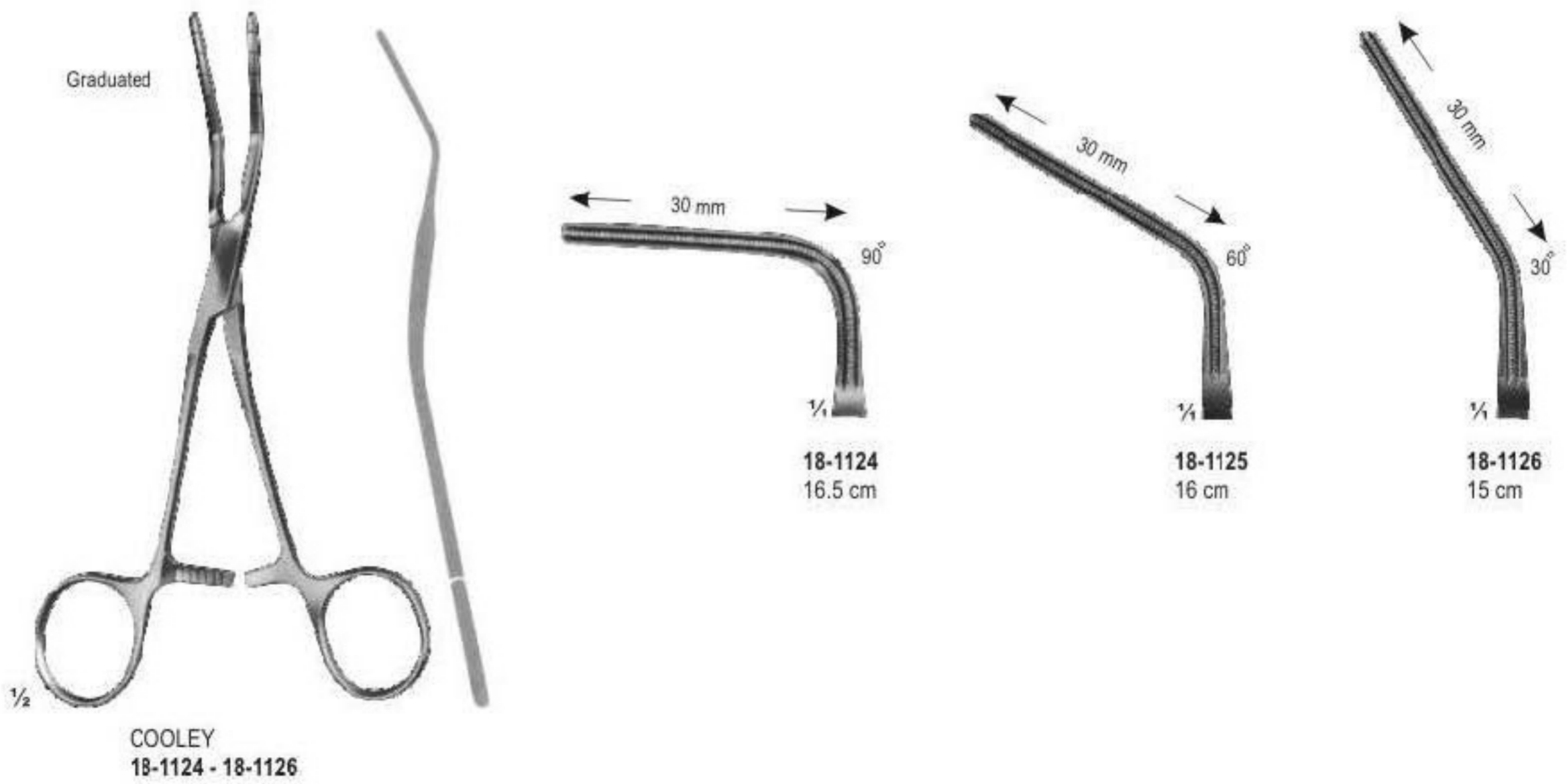
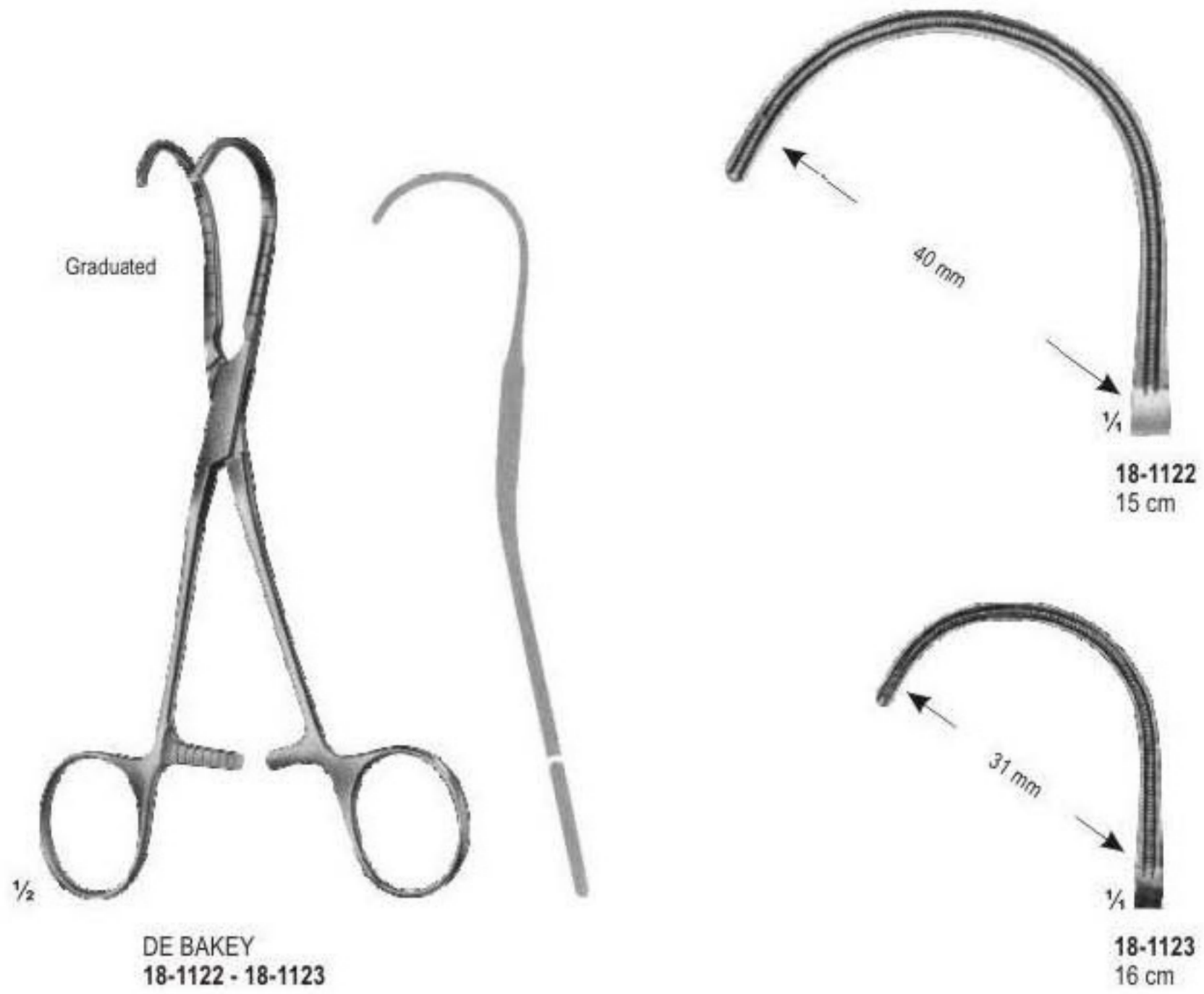

Anastomosis-and Multi-purpose-clamps-paediatric Types

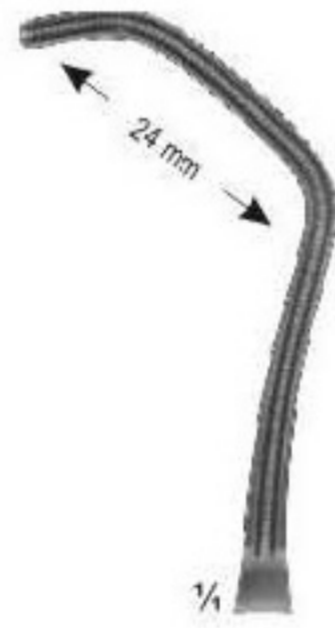
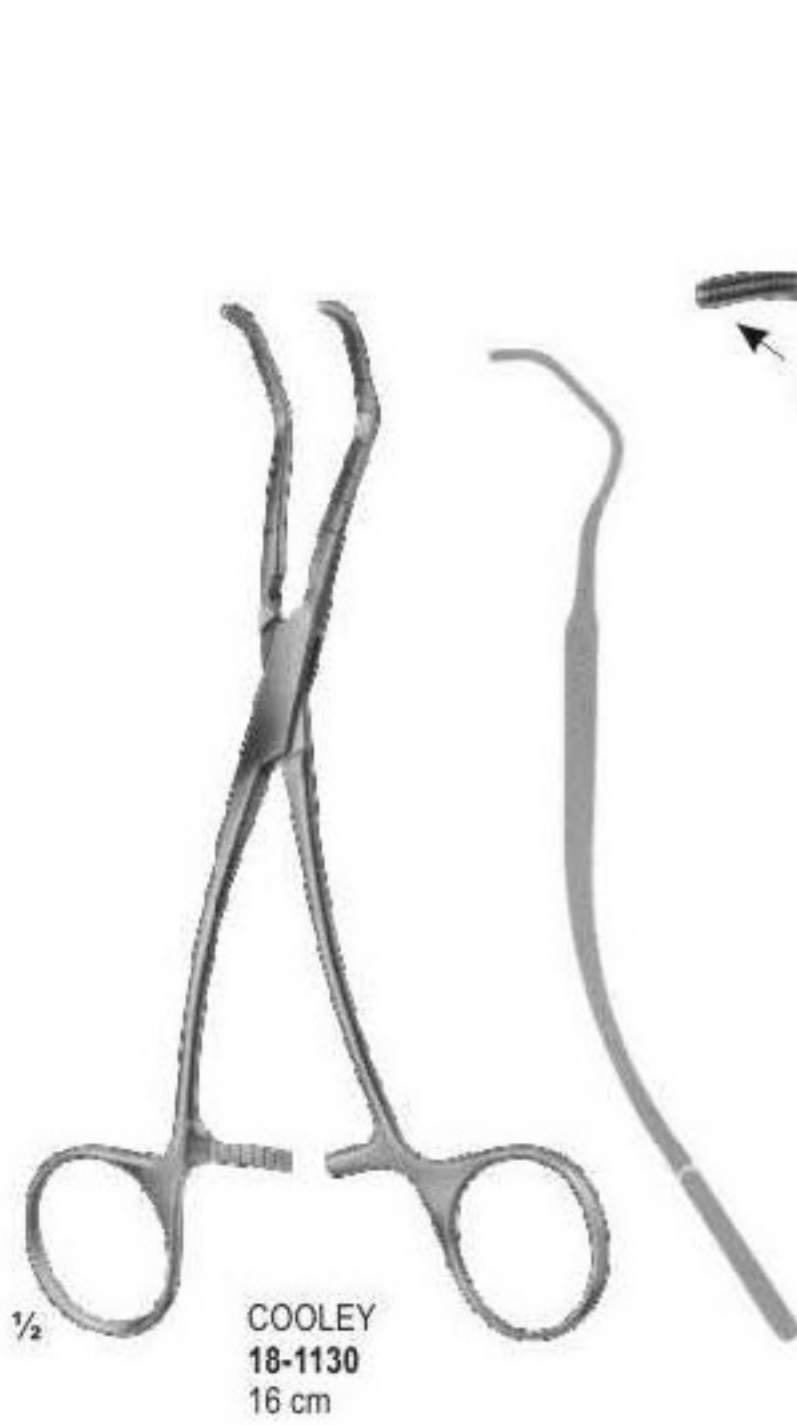
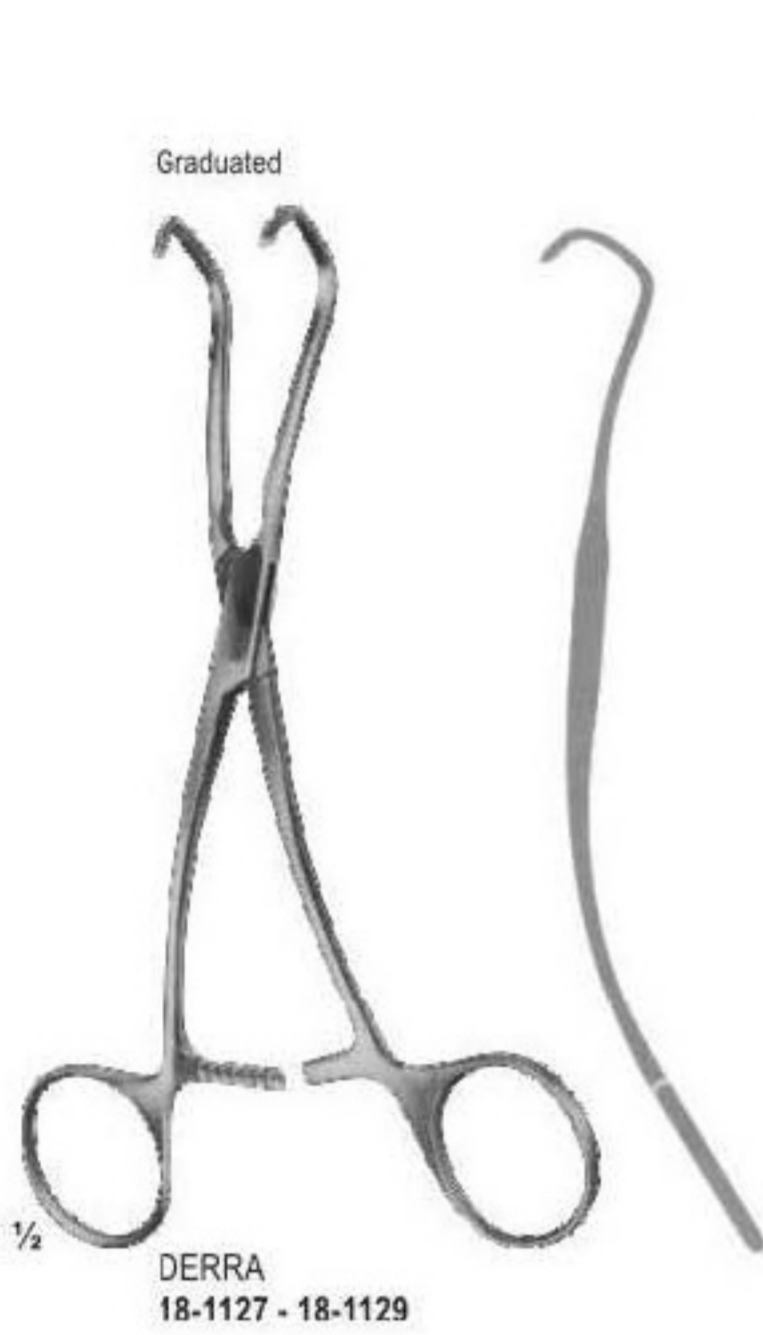

Vena-cava Clamps



HOPT
18-1132 23 cm
18-1133 23.5 cm
18-1134 24.5 cm



18-1132
40 mm



18-1133
50 mm



18-1134
60 mm



DE BAKEY
18-1135 17 cm
18-1136 16.5 cm



1/4
18-1135
50 mm



1/4
18-1136
50 mm



DE BAKEY
18-1137
16.5 cm



1/4
50 mm

Anastomosis Clamps



DE-BAKEY-RUMEL
18-1138 - 18-1139
18-1138 25 cm
18-1139 24.5 cm

DE-BAKEY-MIXTER
18-1140
28.5 cm

DE-BAKEY-MC QUIGG-MIXTER
18-1141
21.5 cm

Multi-Purpose Clamps



SATINSKY
18-1142
26.5 cm

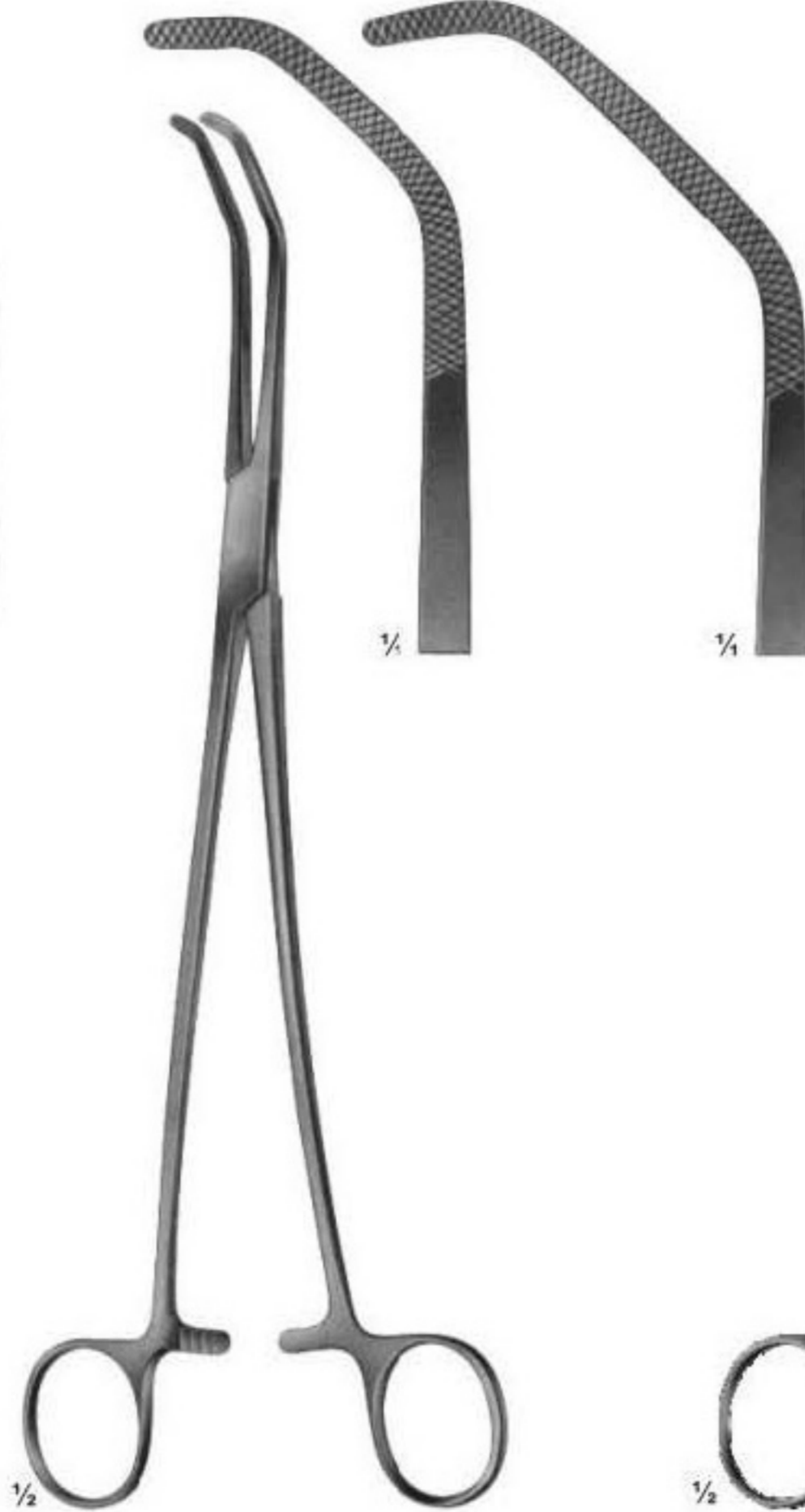

SATINSKY
18-1143
26.5 cm

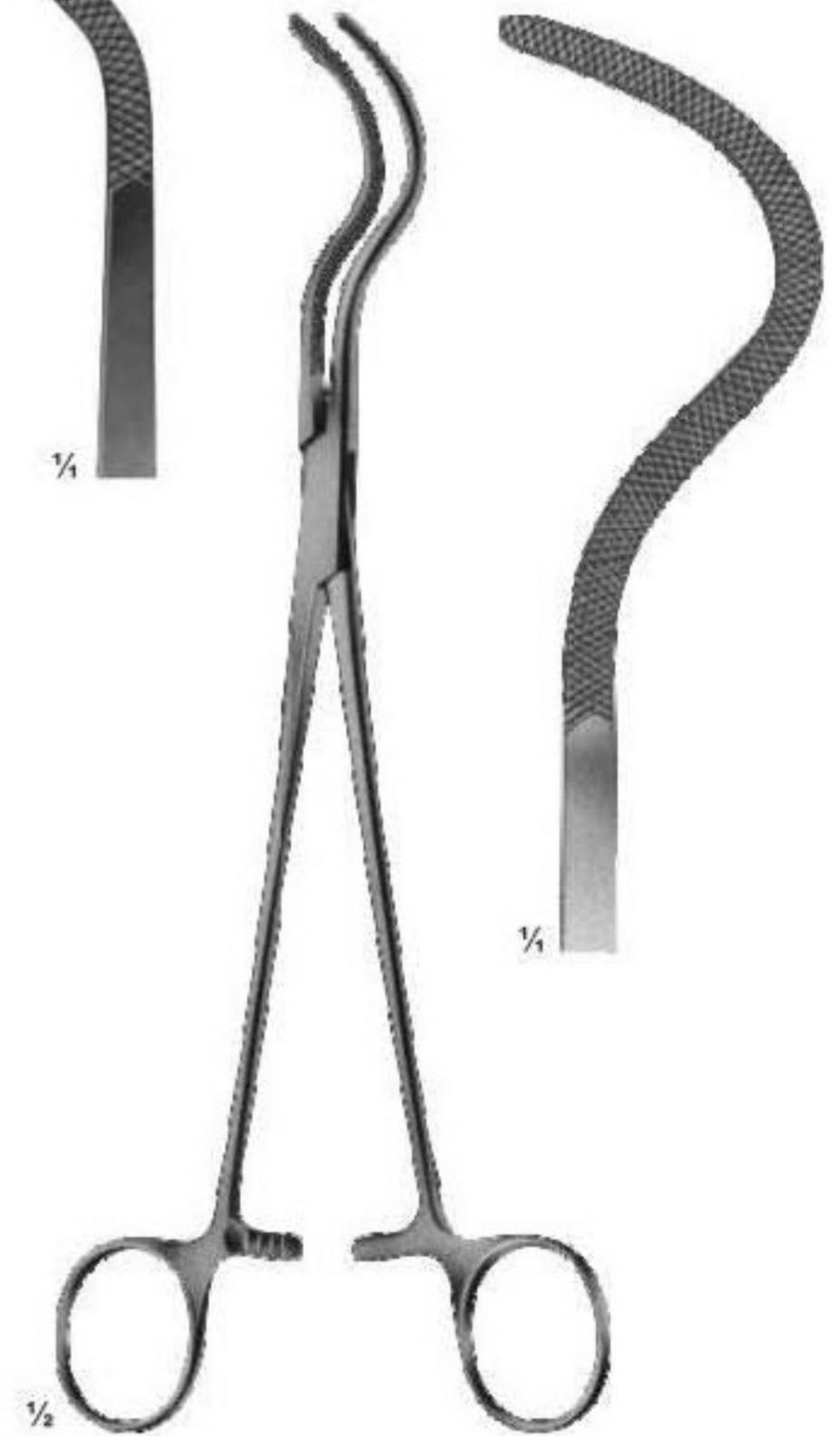

HARKEN
18-1144
24 cm

Multi-Purpose Clamps



CRAFOORD-SELLORS
18-1145
24 cm



CRAFOORD
18-1146 - 18-1147
24 cm



Anastomosis Clamps & Vena-cava Clamps

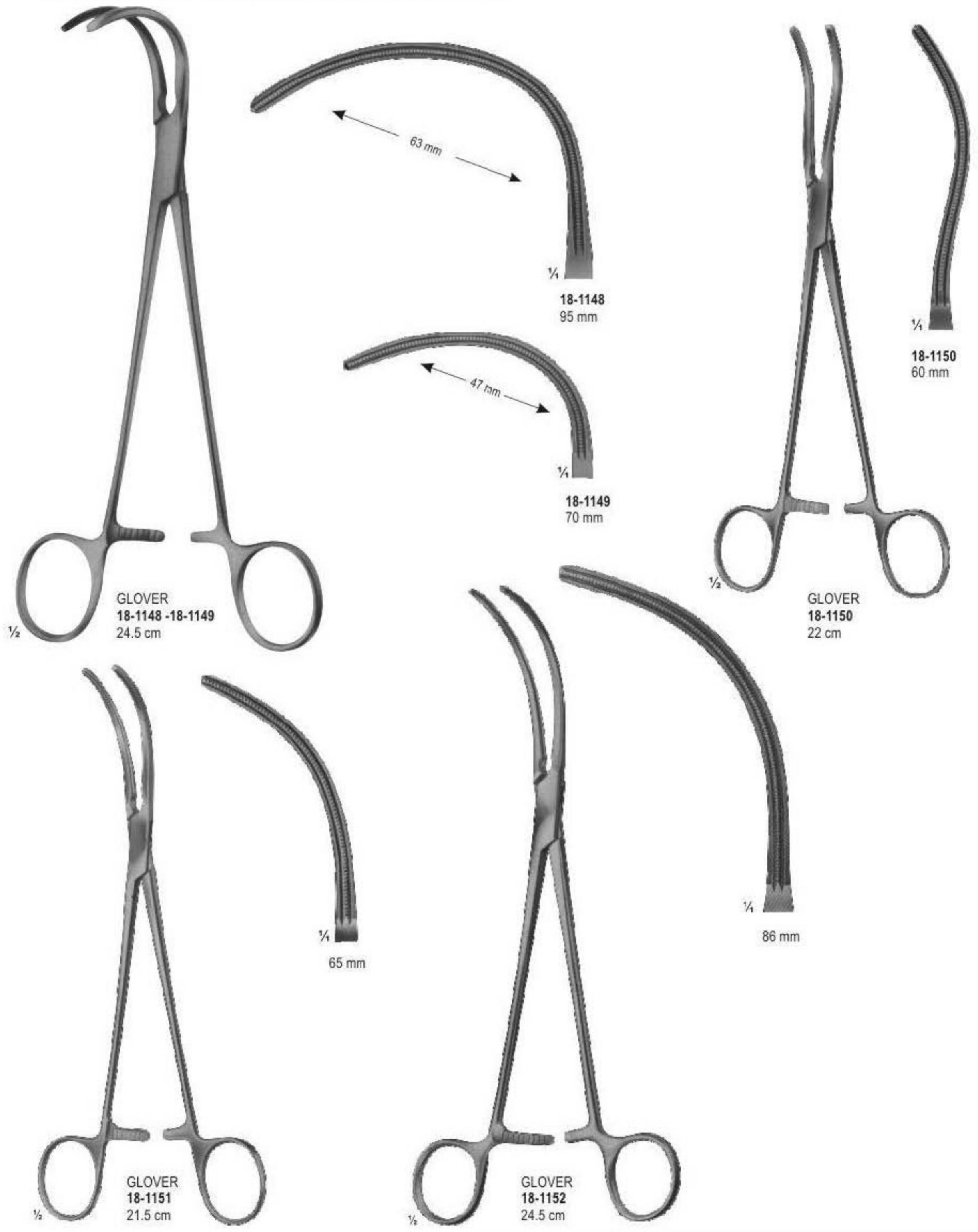

Vena-cava Clamps



DE BAKEY
18-1153 - 18-1157

Total Length:
Length of jaws:

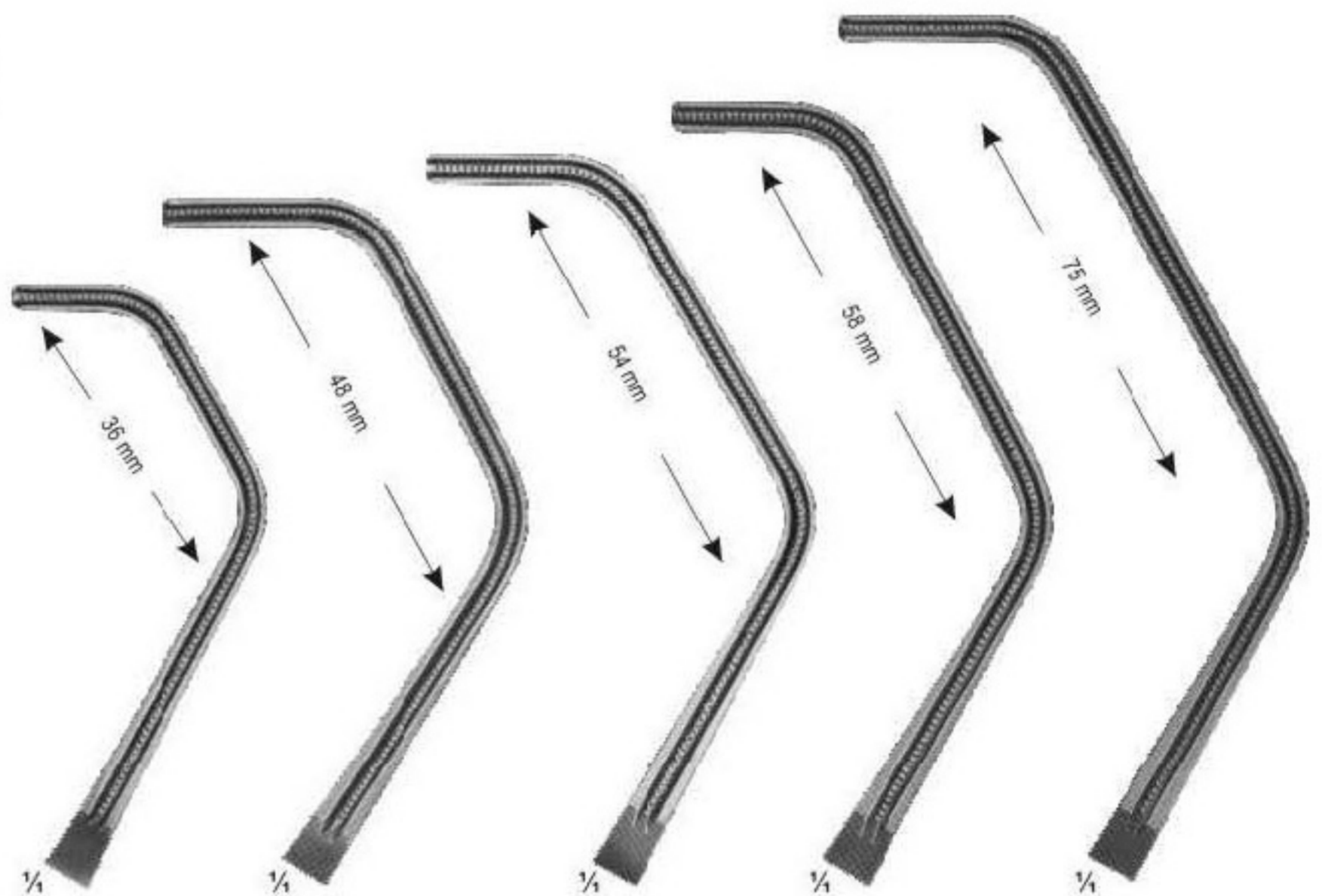

18-1153
220 mm
85 mm

18-1154
256 mm
95 mm

18-1155
270 mm
99 mm

18-1156
270 mm
103 mm

18-1157
280 mm
119 mm



DE BAKEY-SATINSKY
18-1158 - 18-1160

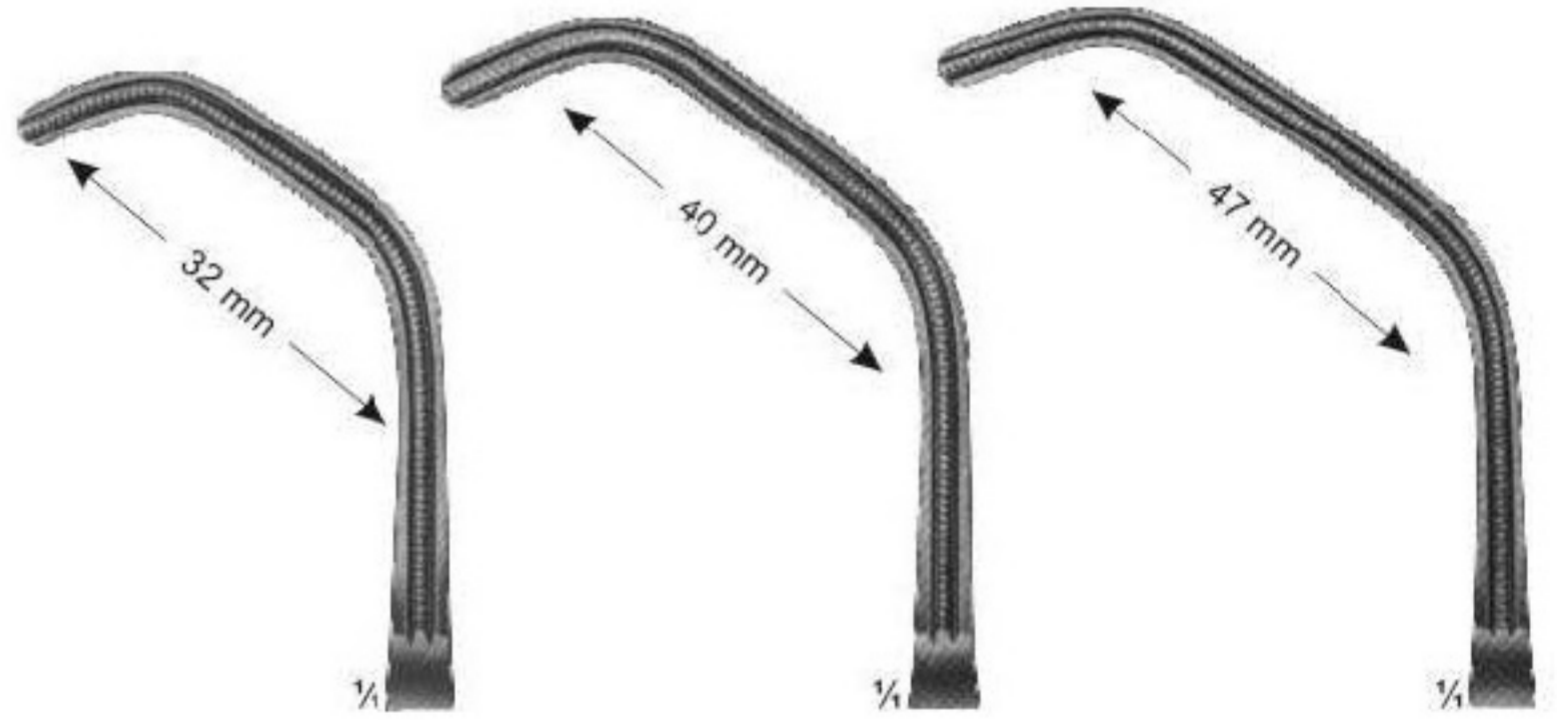

18-1158
23.5 cm

18-1159
23.5 cm

18-1160
23.5 cm

Vena-cava Clamps

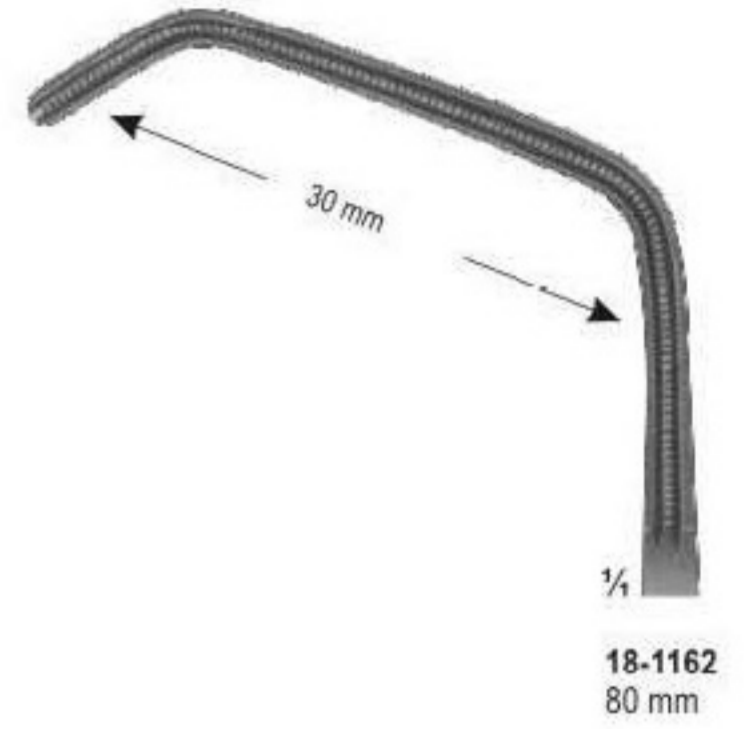
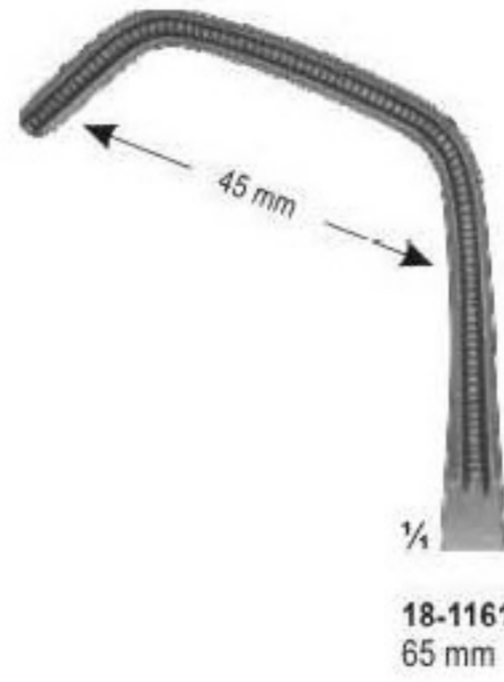

DE BAKEY-HARKEN
18-1163 25.5 cm
18-1164 24.5 cm
18-1165 24.5 cm
18-1166 24.5 cm



Vena-cava Clamps

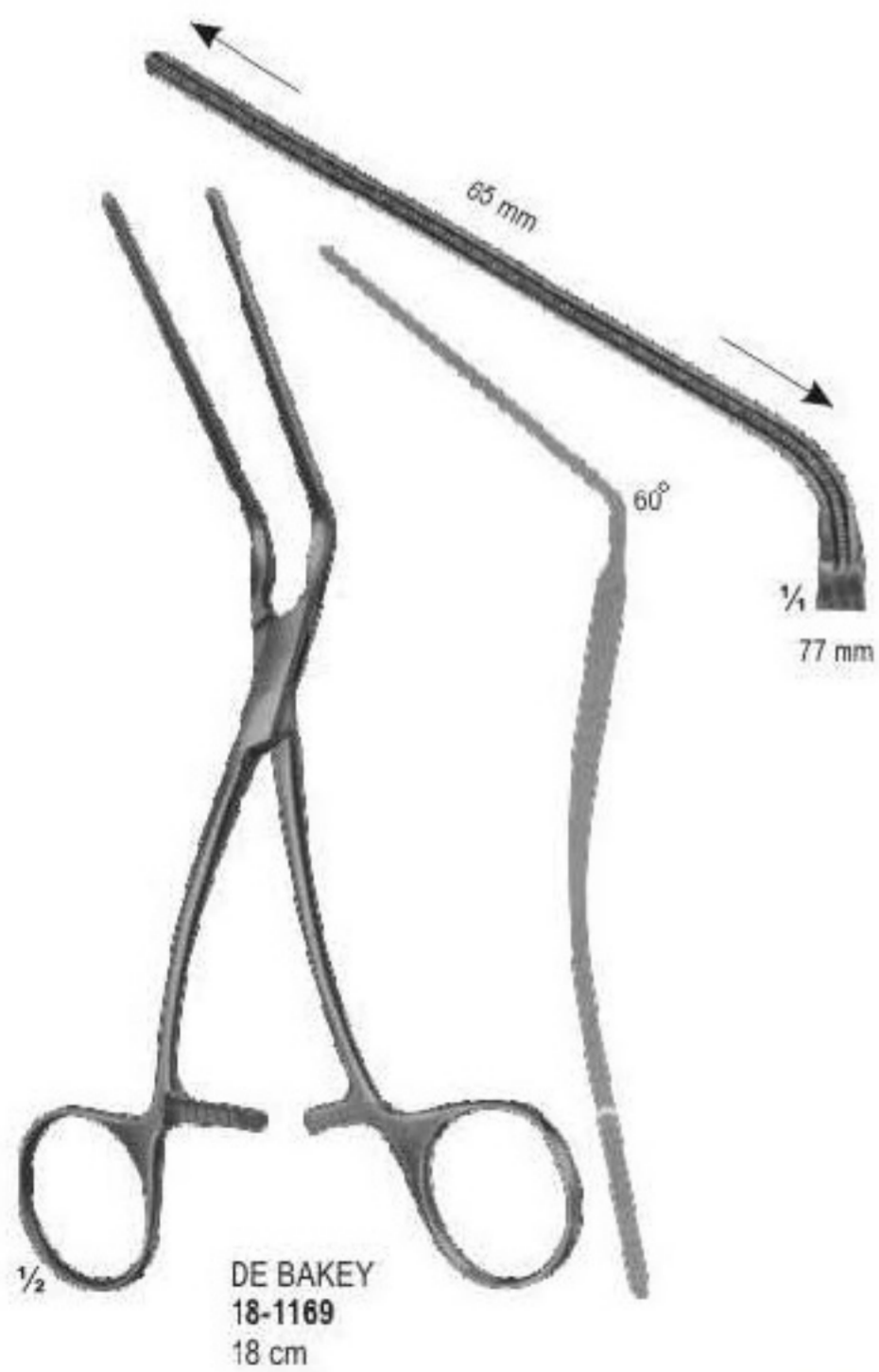
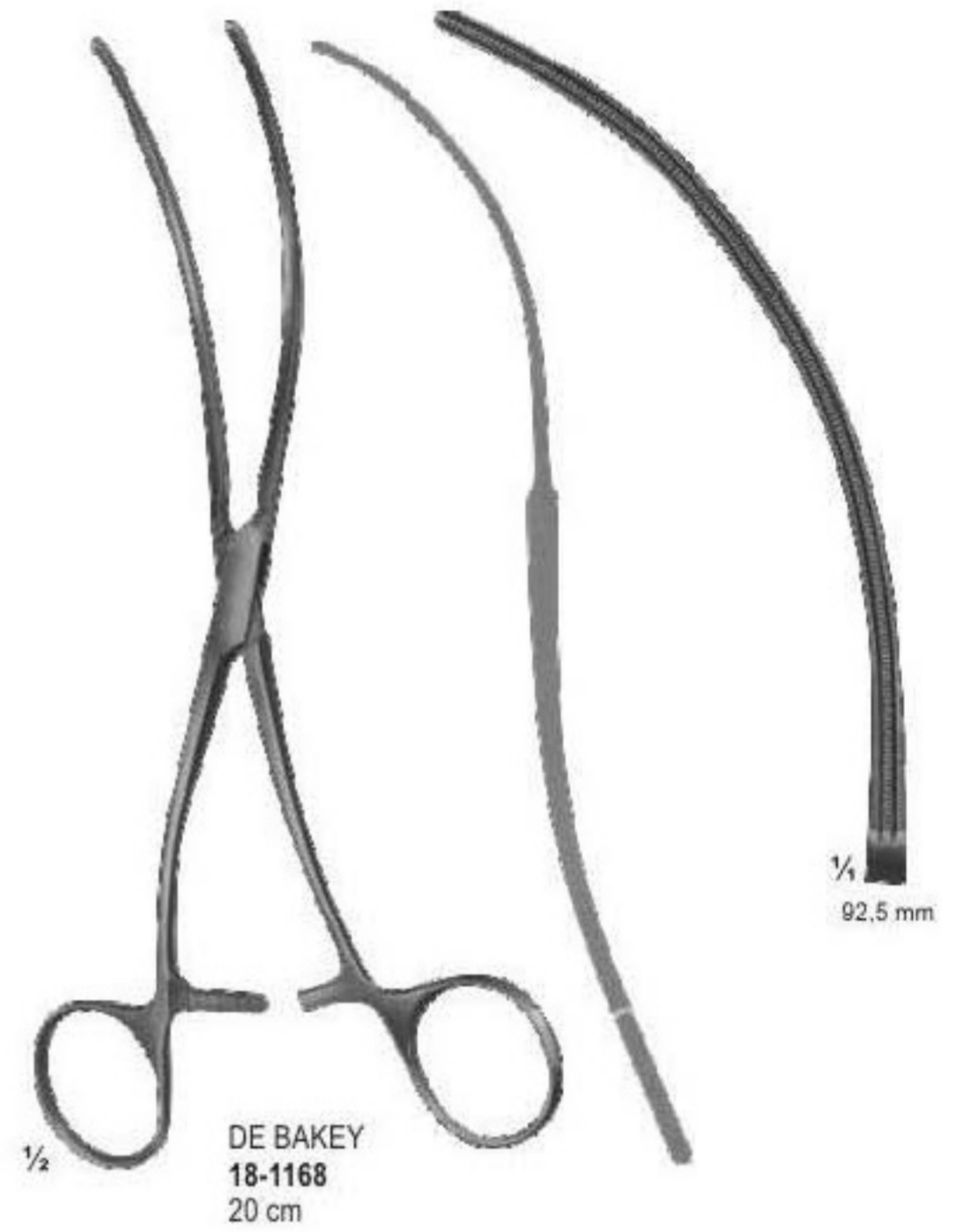
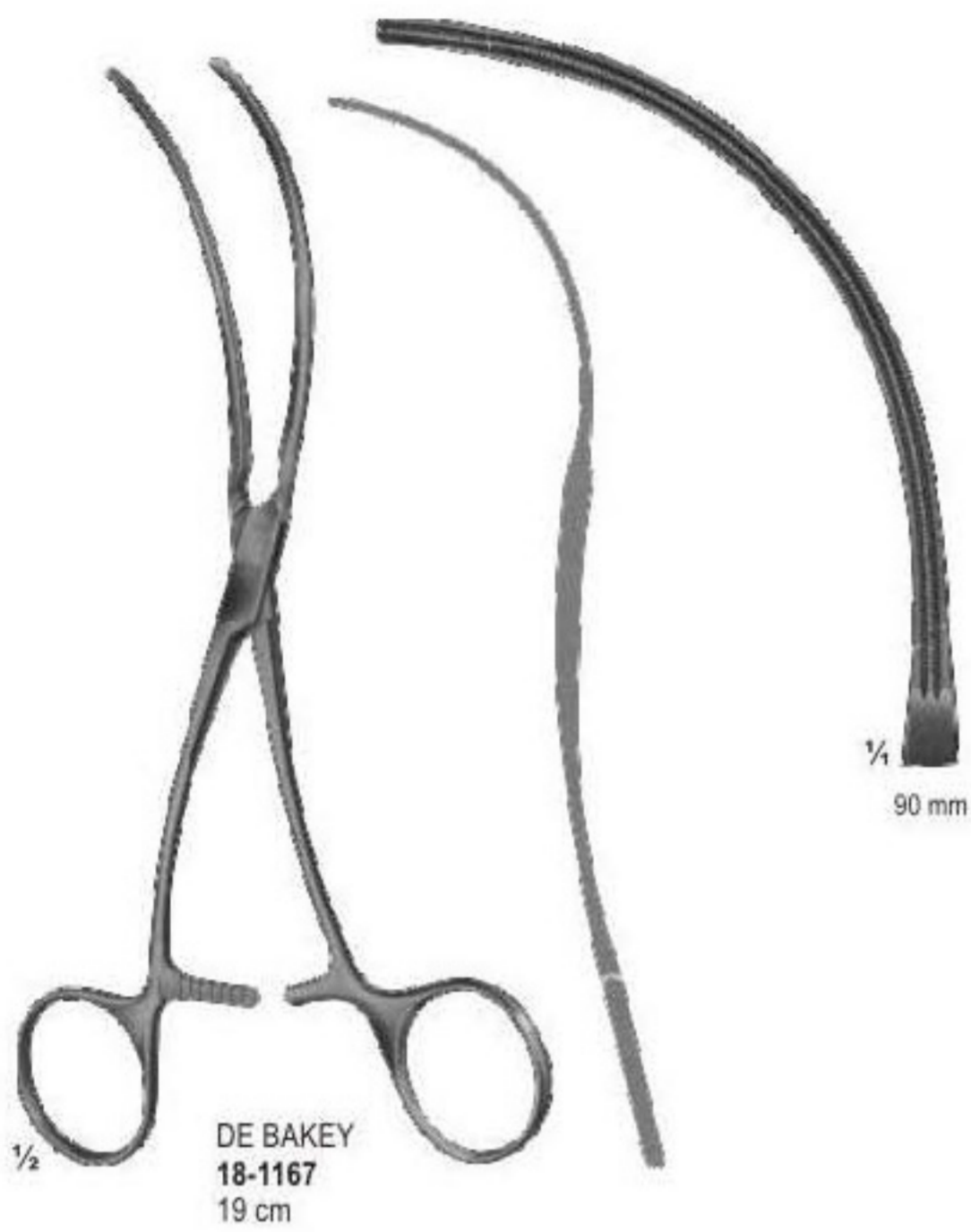

Vena-cava Clamps



1/4
18-1172
41 mm



1/4
18-1173
65 mm



1/4
18-1174
80 mm



1/2
DE BAKEY
18-1175 20.5 cm
18-1176 22.5 cm
18-1177 24 cm



1/4
18-1175
41 mm



1/4
18-1176
65 mm



1/4
18-1177
80 mm



1/2
DE BAKEY
18-1178
21 cm



1/4
51 mm



1/2
DE BAKEY
18-1179
21 cm



15°
51 mm



1/2
DE BAKEY
18-1180
16 cm

56 mm

Vena-cava Clamps

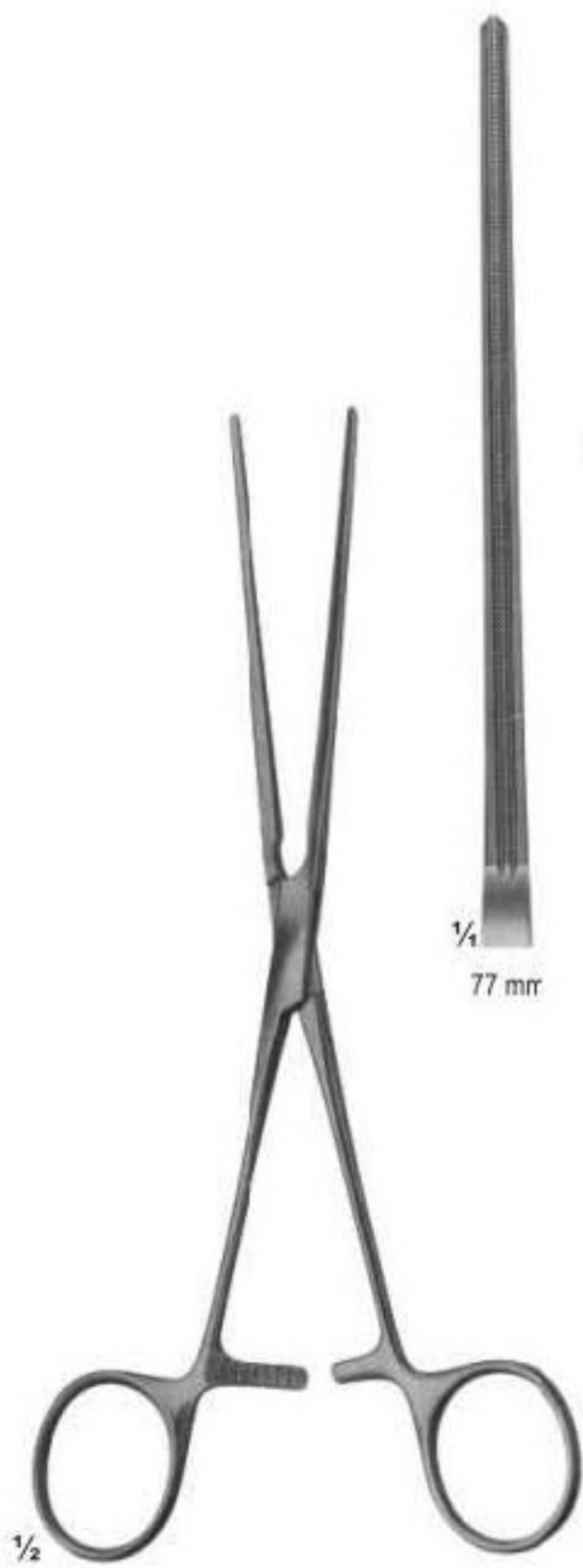

LELAND-JONES
18-1181
19.5 cm



DE BAKEY
18-1182
20 cm

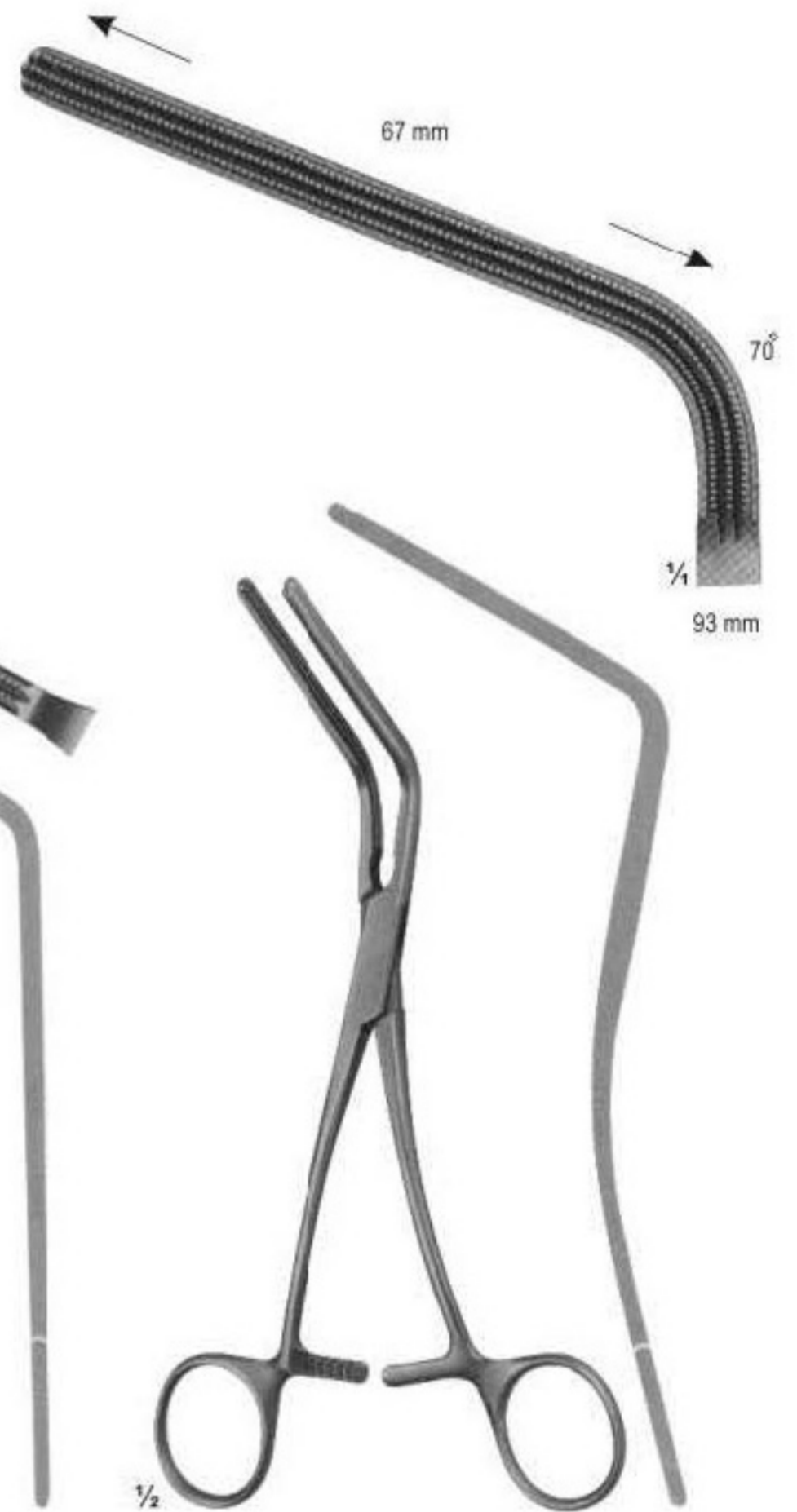

MORRIS
18-1183
17.5 cm

Vena-cava Clamps

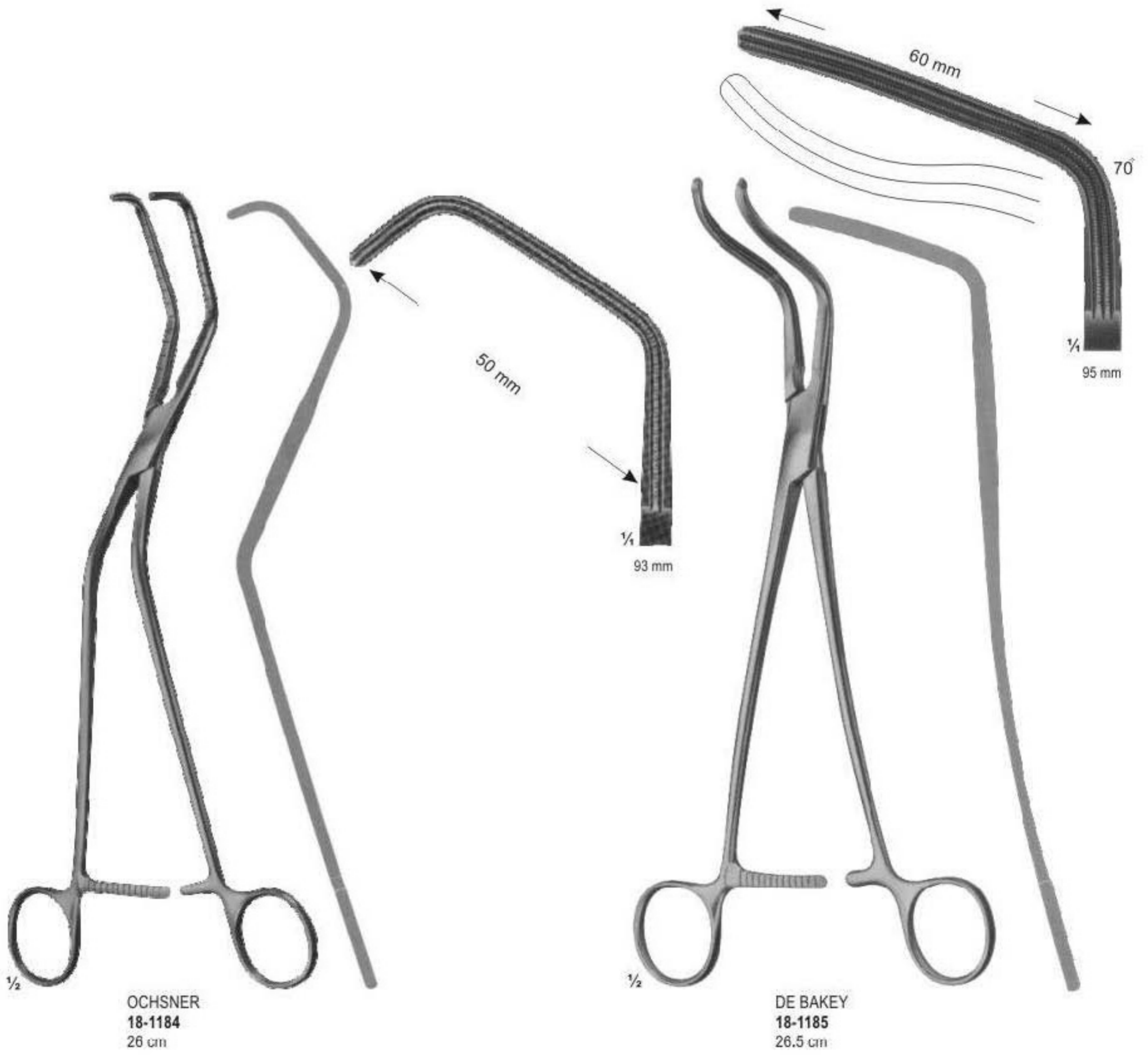

Vena-cava Clamps

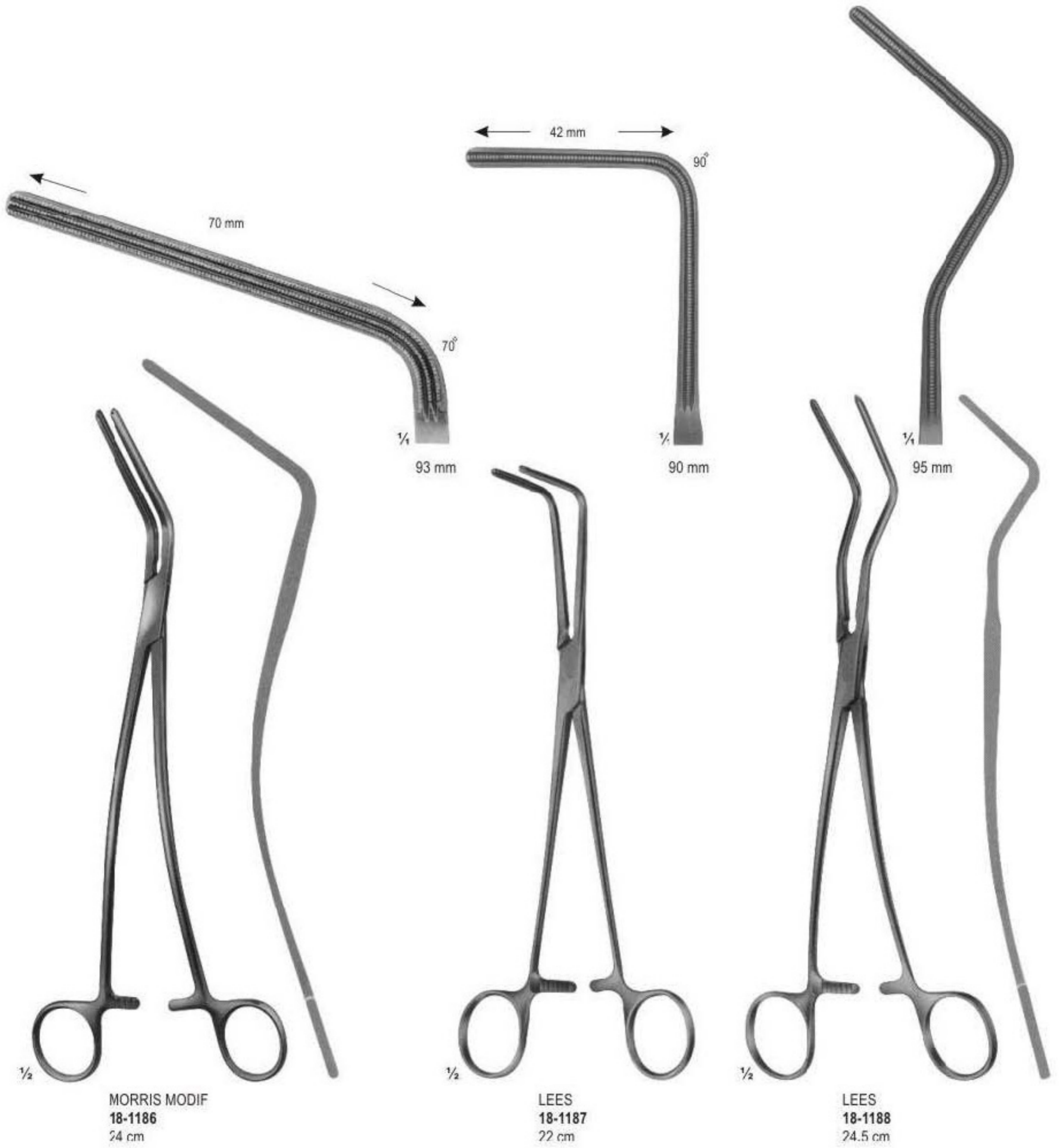

Vena-cava Clamps

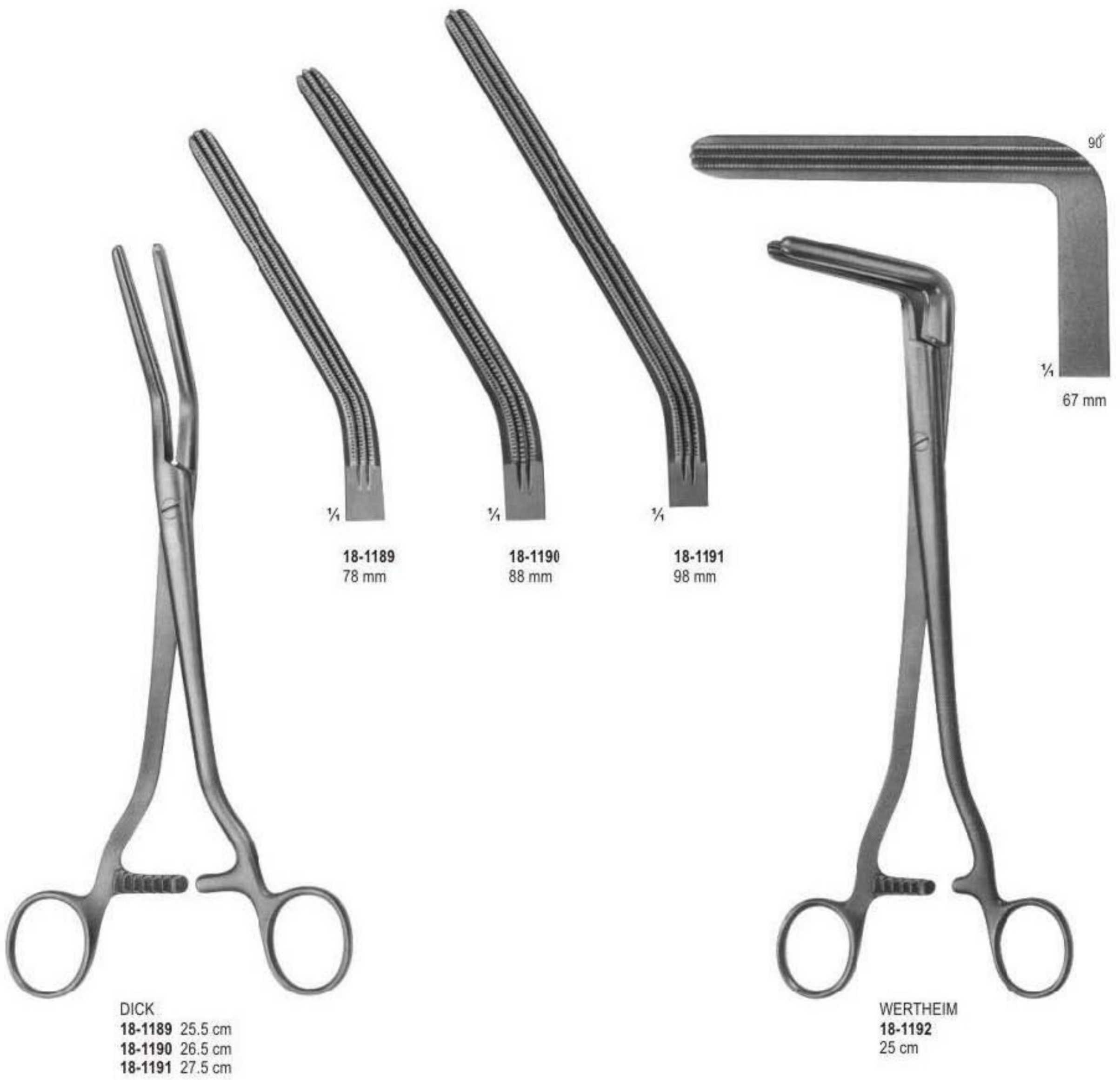

Vena-cava Clamps

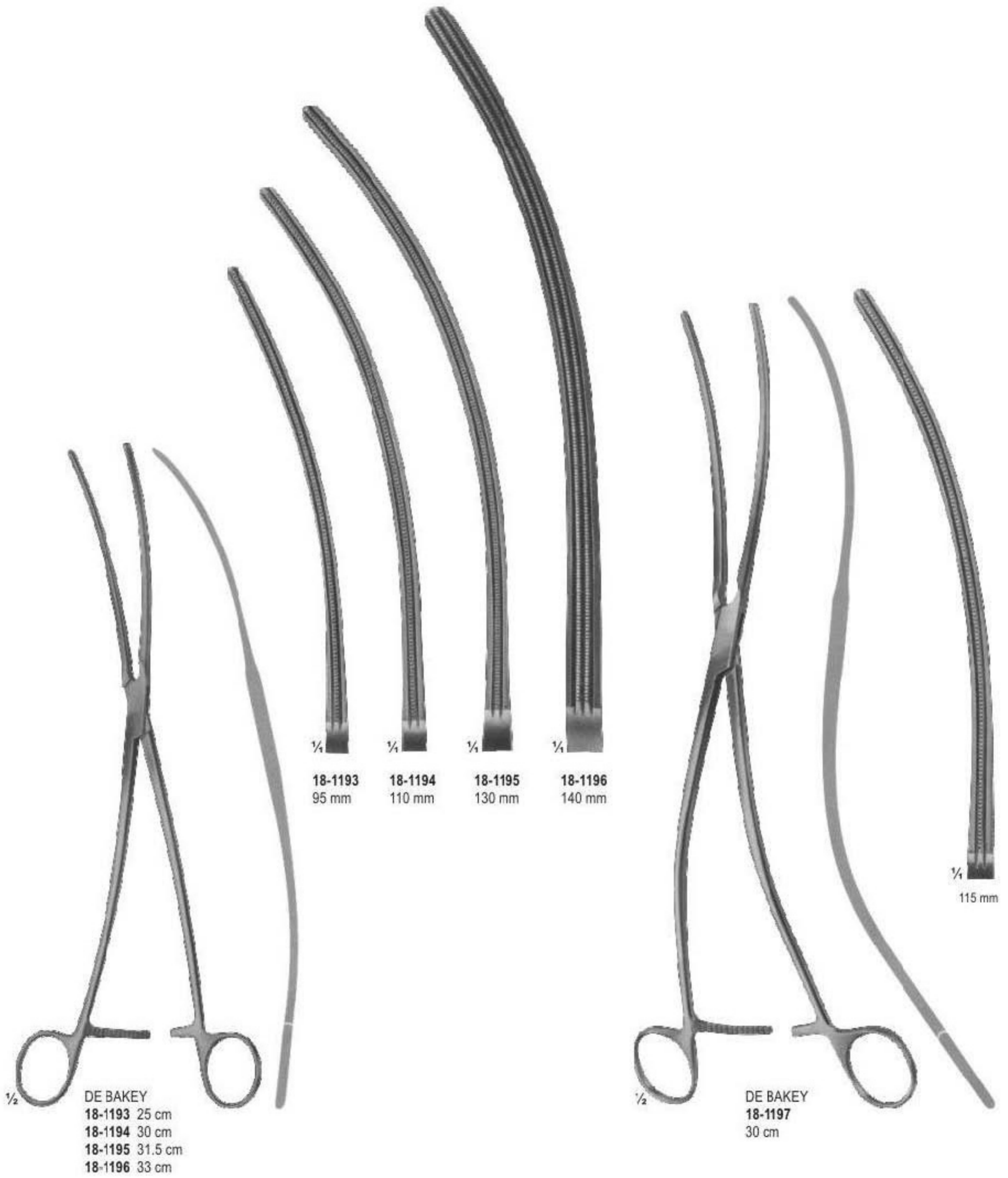

Vena-cava Clamps



DIETRICH
18-1198
21 cm

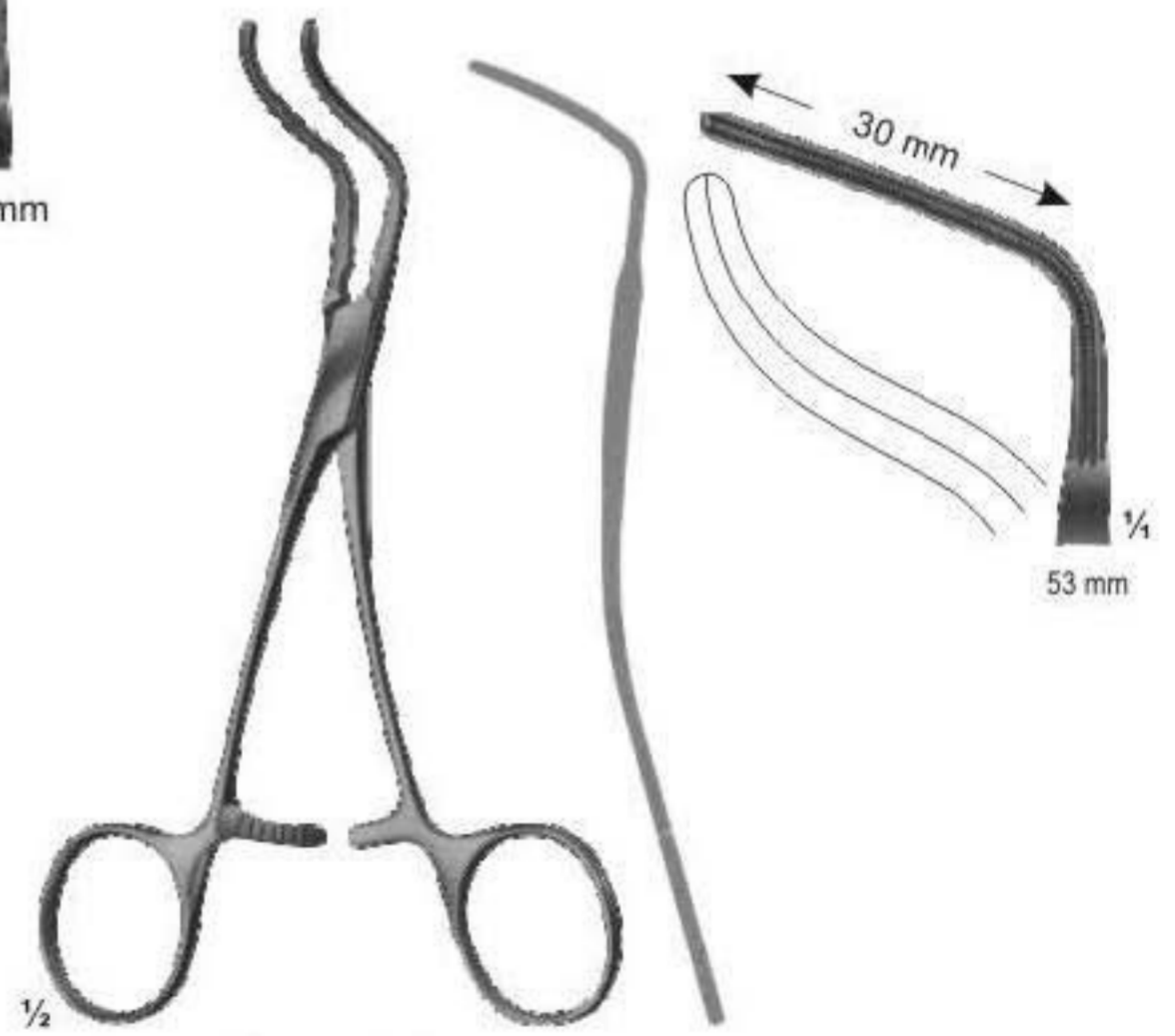

SUBRAMANIAN
18-1199
15.5 cm

Ligature Forceps

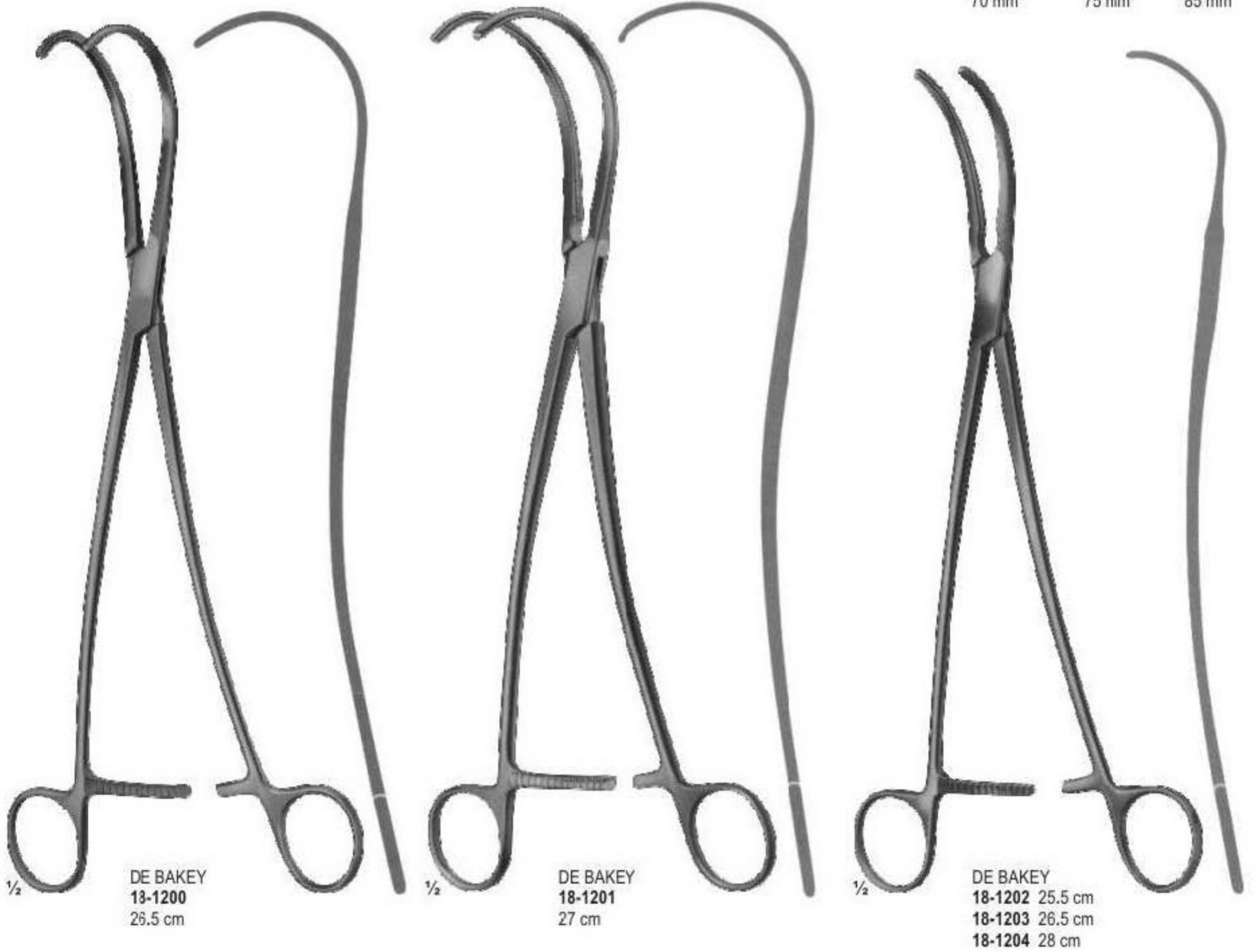
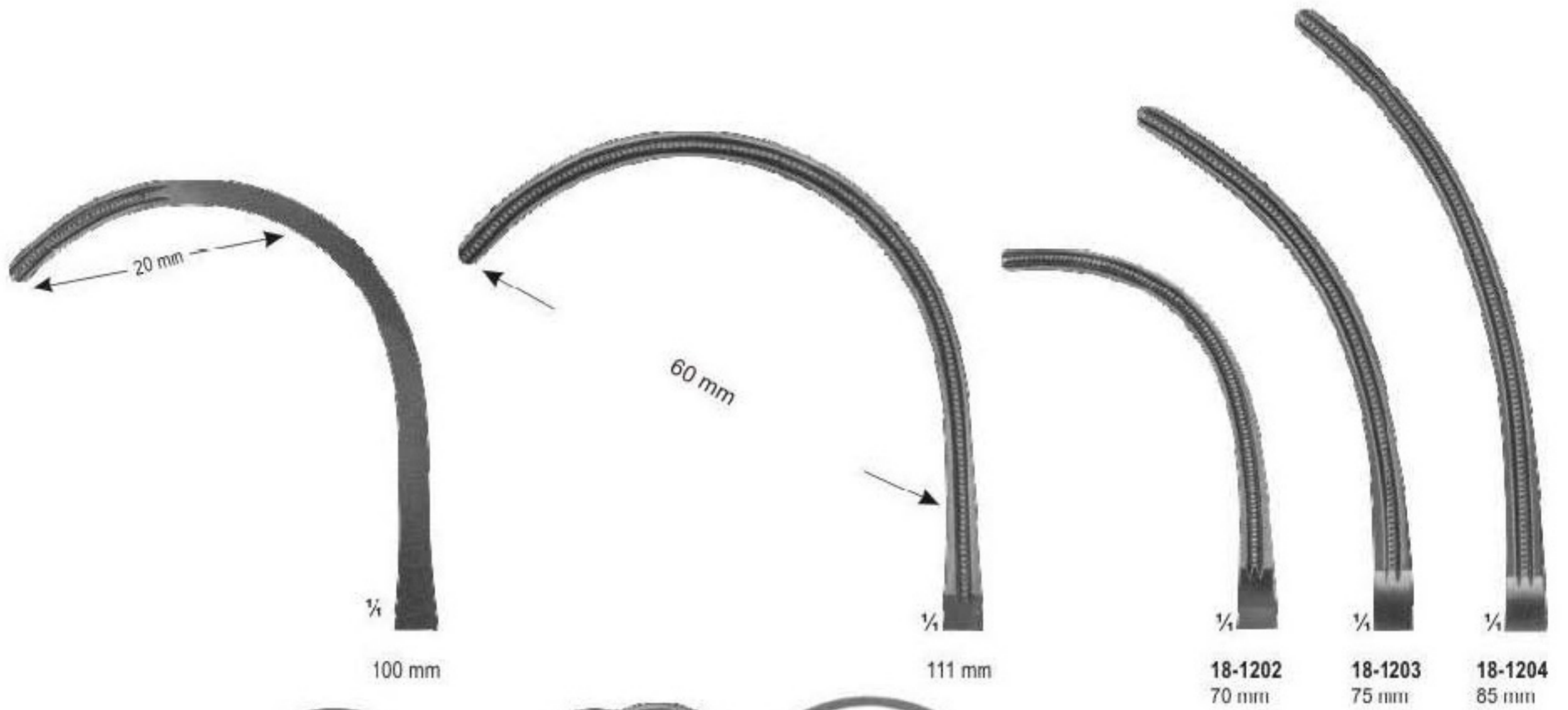

Aorta-anastomosis Clamps



Aorta-anastomosis Clamps, Forceps For Vena Cava



18-1207
22.5 cm



18-1208
23 cm

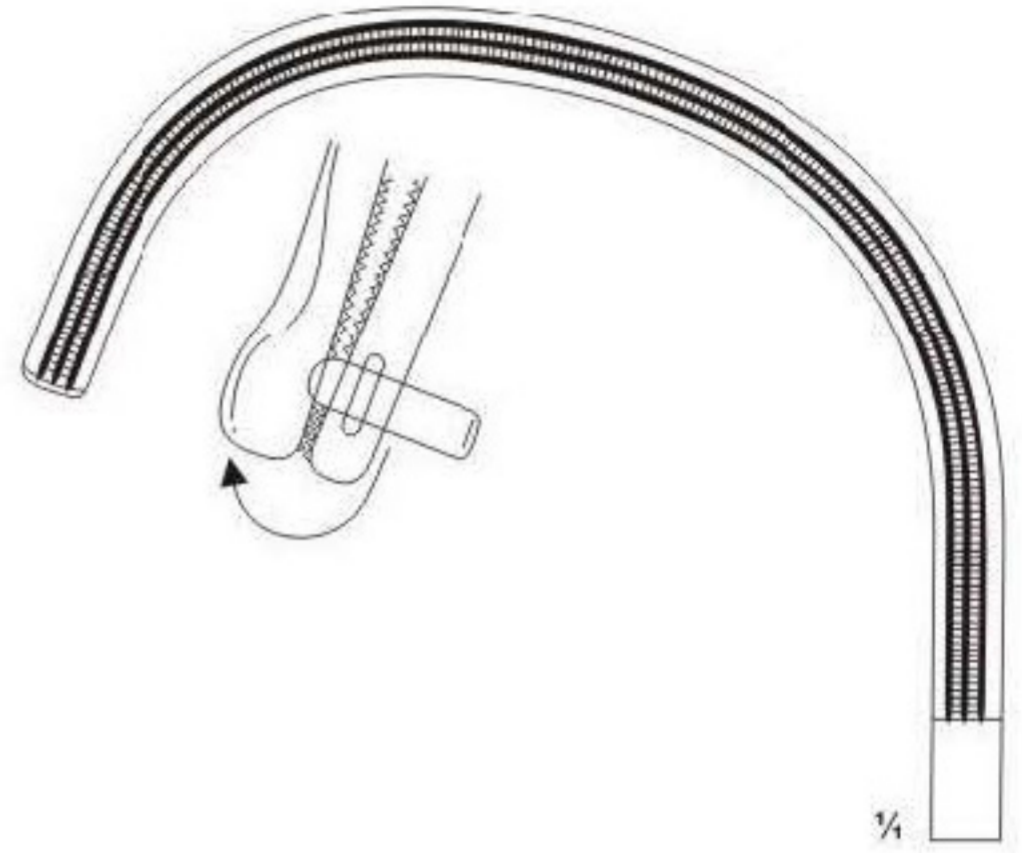

$\frac{1}{4}$



$\frac{1}{2}$
WYLIE
18-1207 - 18-1208



$\frac{1}{2}$
CALNE
18-1209
27 cm

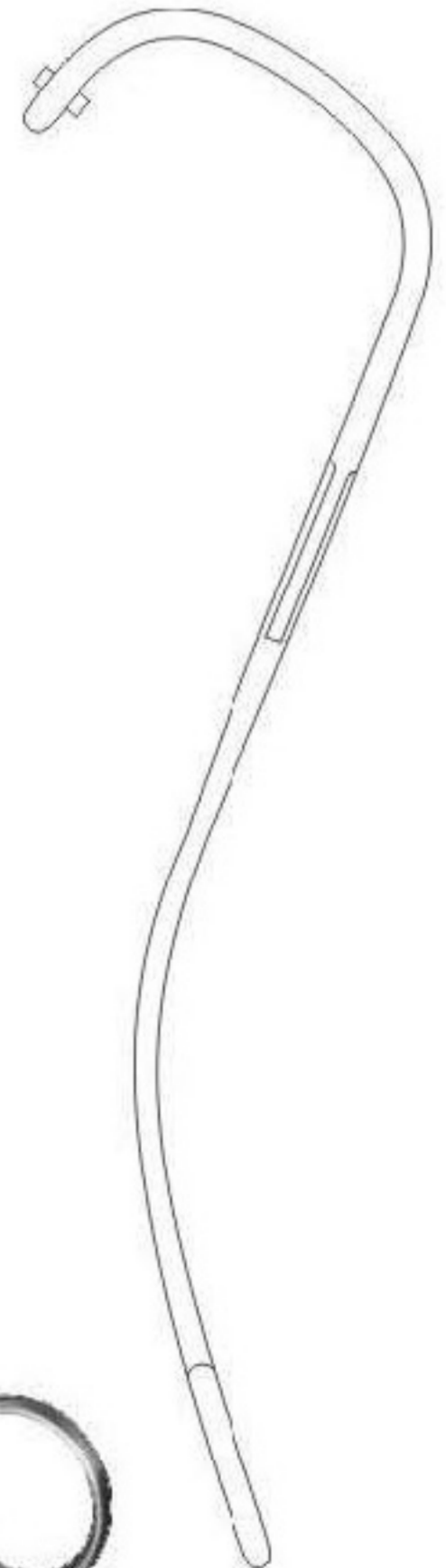

Liver Forceps

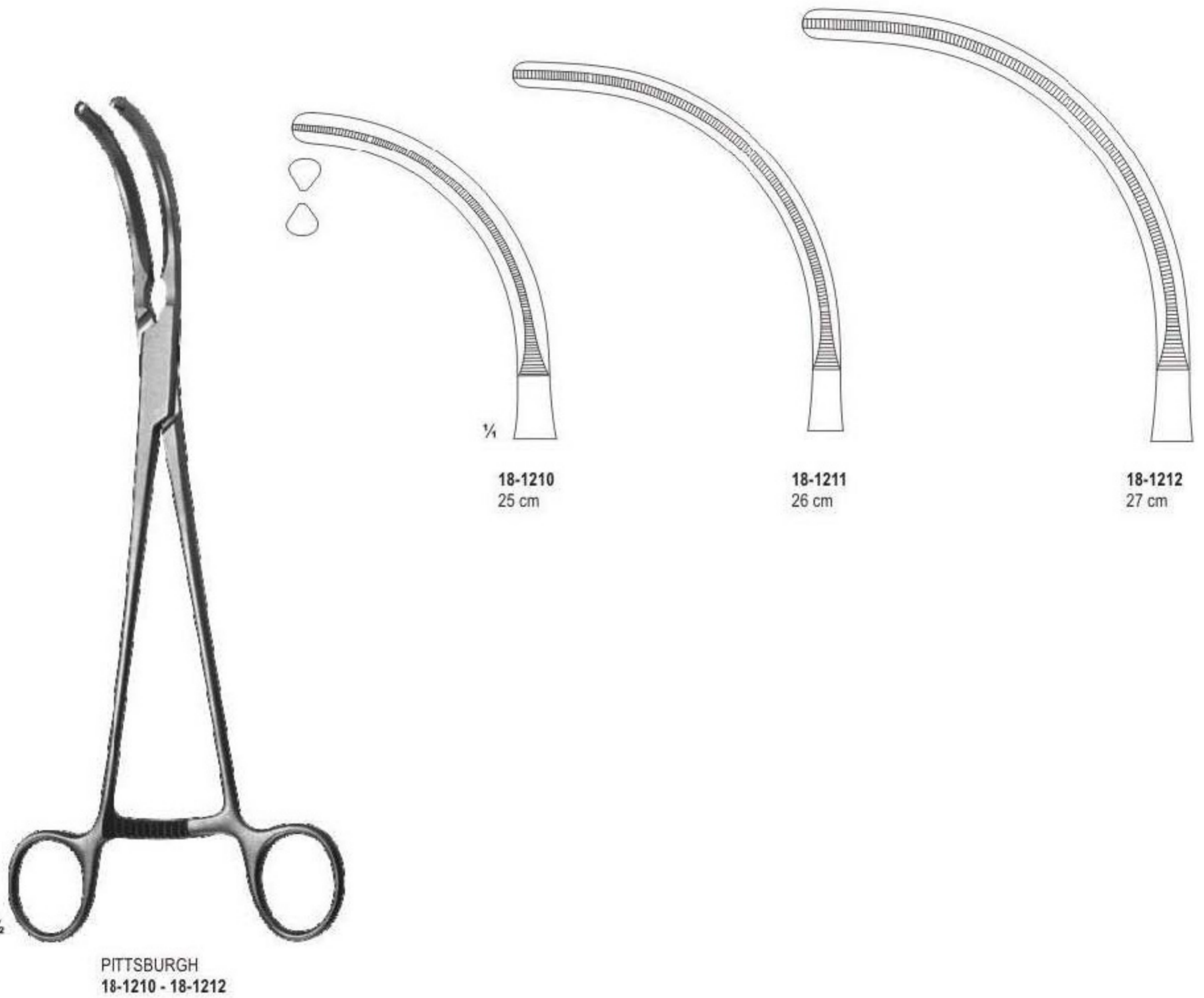

Aorta-anastomosis Clamps

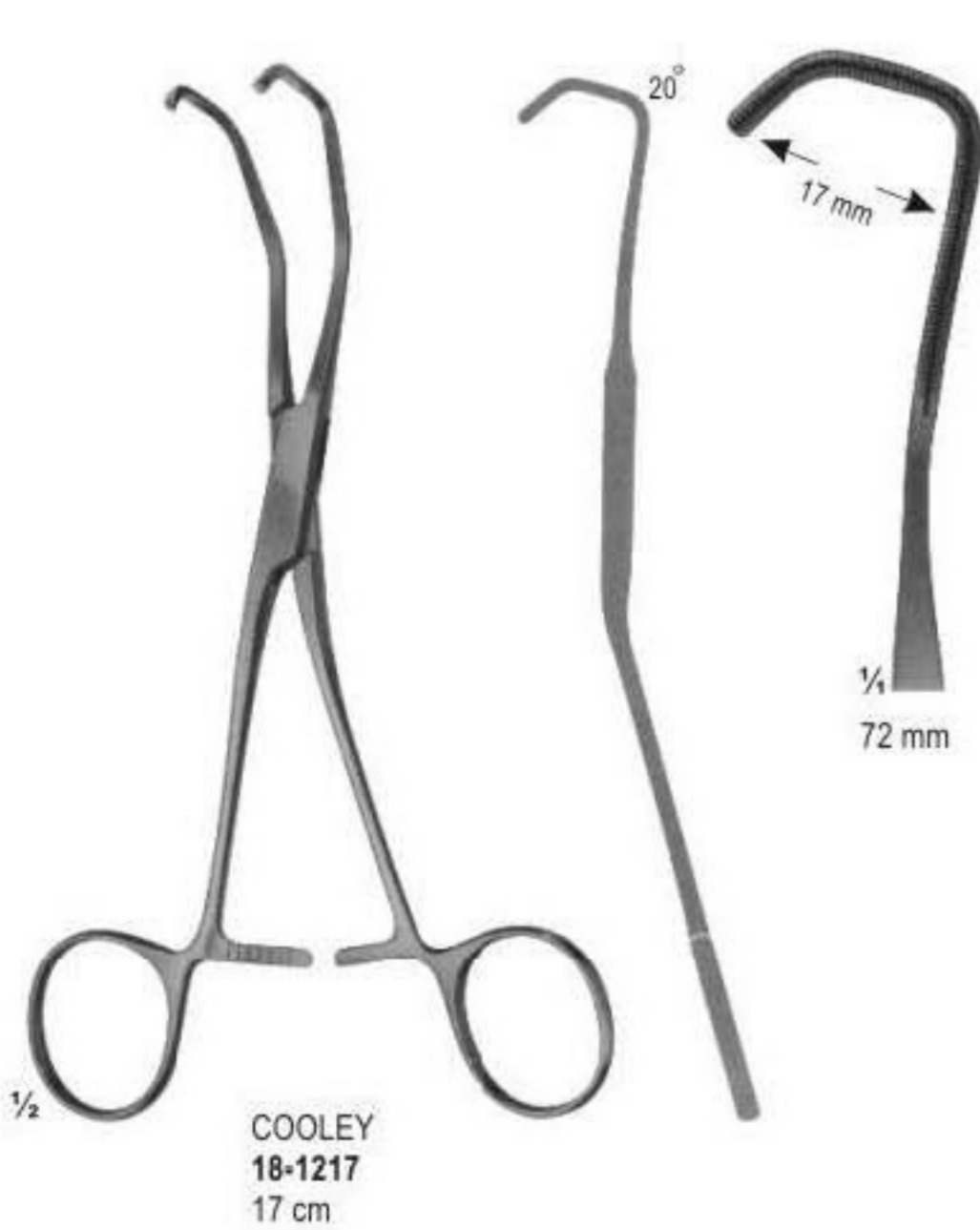
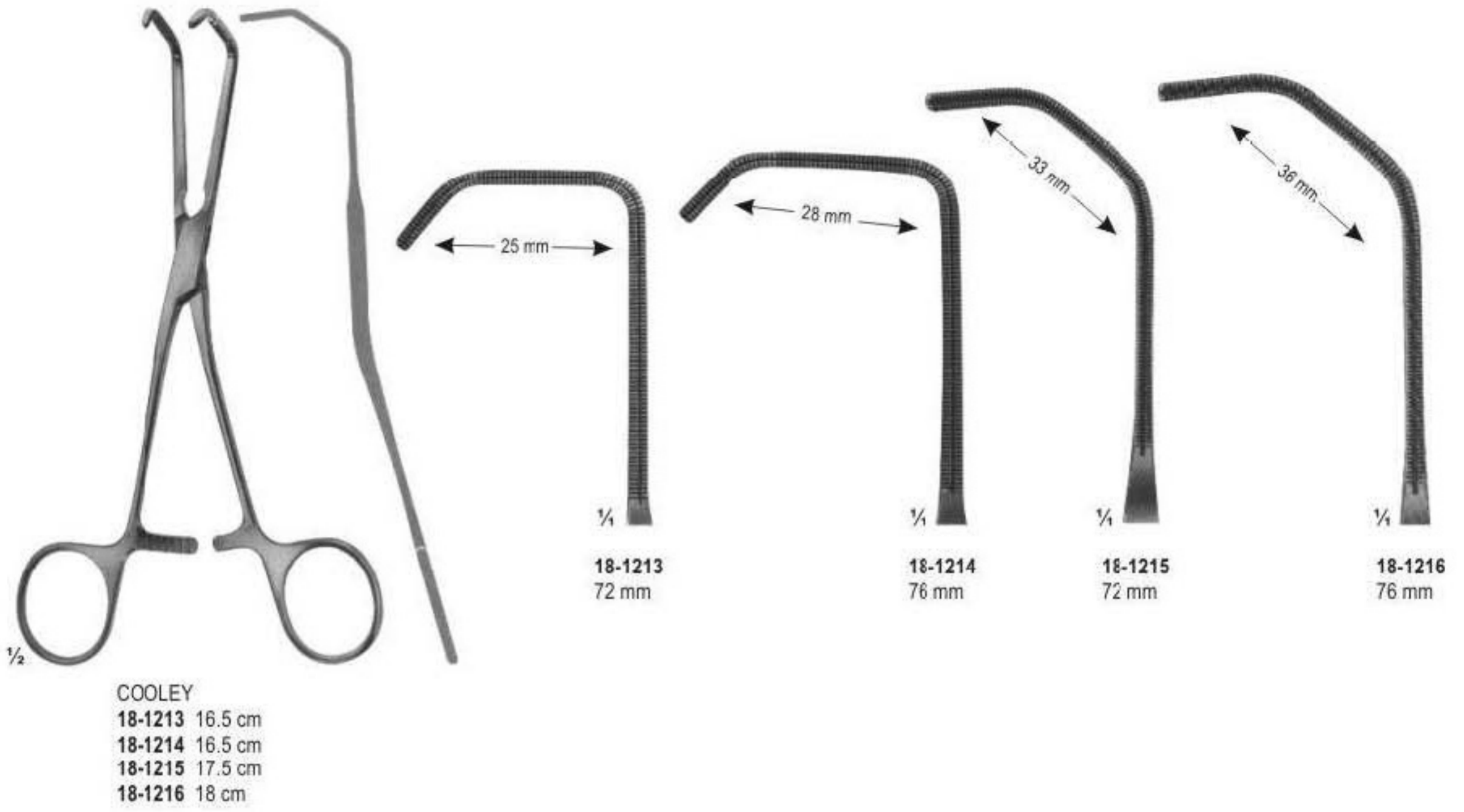

Auricle Clamps

ATRAUMA



$\frac{1}{4}$
18-1219
24.5 cm



$\frac{1}{4}$
18-1220
24 cm



$\frac{1}{2}$
HARKEN
18-1219 - 18-1222



$\frac{1}{4}$
18-1221
23 cm



$\frac{1}{4}$
18-1222
23.5 cm

Aanastomosis And Aneurysm Clamps

ATRAUMA



$\frac{1}{2}$ GLOVER
18-1223 - 18-1224

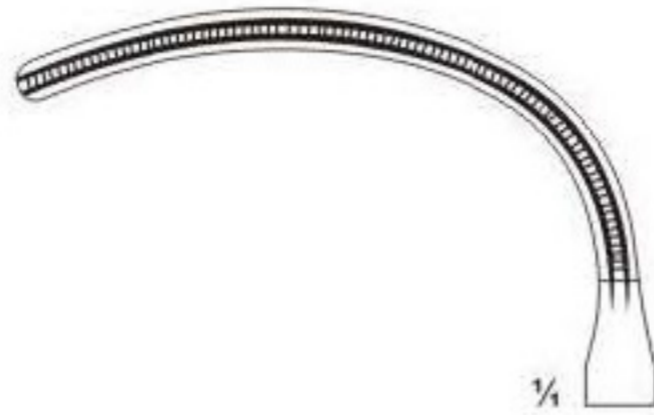

$\frac{1}{4}$
18-1223
18 cm

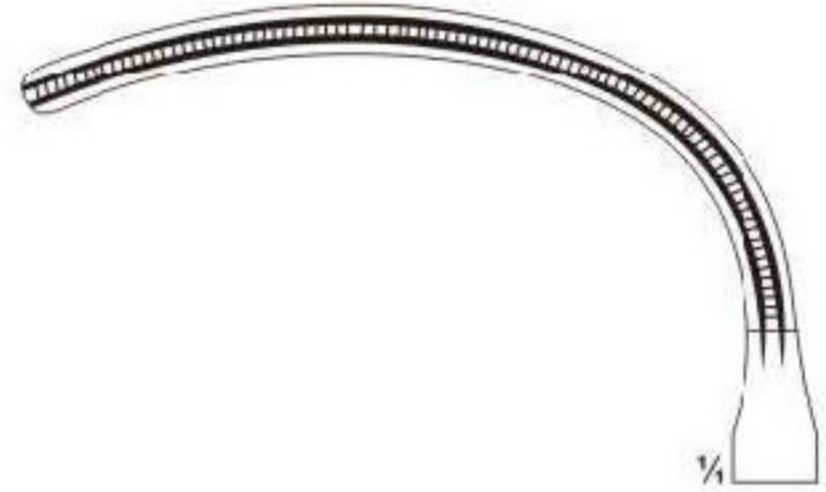

$\frac{1}{4}$
18-1224
22 cm



$\frac{1}{2}$ DE BAKEY-BAHNSON
18-1225 - 18-1227



$\frac{1}{4}$
18-1225
23.5 cm



$\frac{1}{4}$
18-1226
24.5 cm



$\frac{1}{4}$
18-1227
25.5 cm

Multi Purpose Vascular Clamps

ATRAUMA



POTTS
18-1228 - 18-1231



18-1228
21.5 cm



18-1229
23.5 cm



18-1230
27 cm



18-1231
31.5 cm

Multi Purpose Vascular Clamps

ATRAUMA



POTTS
18-1232 - 18-1235



18-1232
21 cm



18-1233
23 cm



18-1234
26 cm



18-1235
31 cm

Aorta-anastomosis Clamps

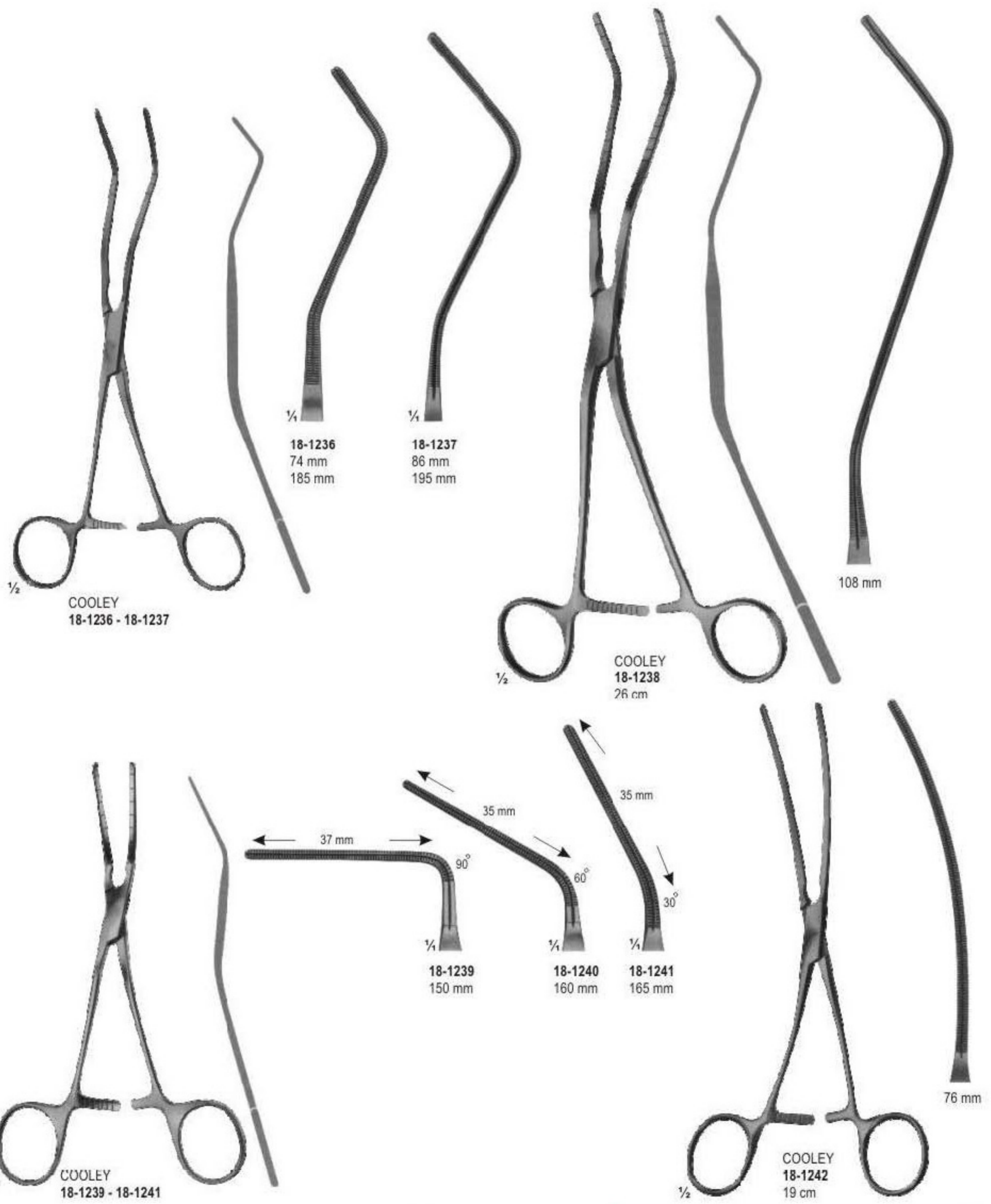

Aorta-anastomosis Clamps

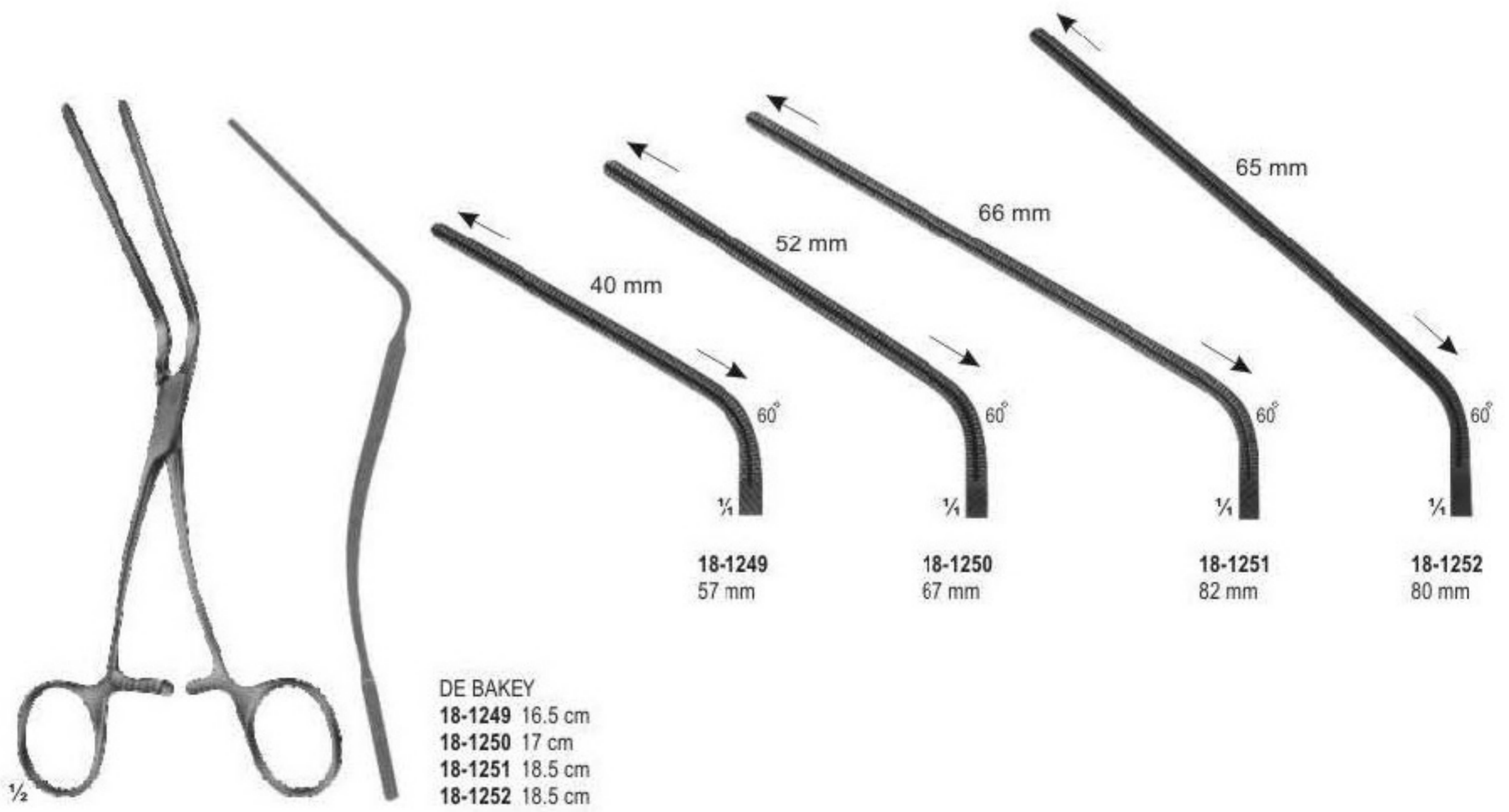
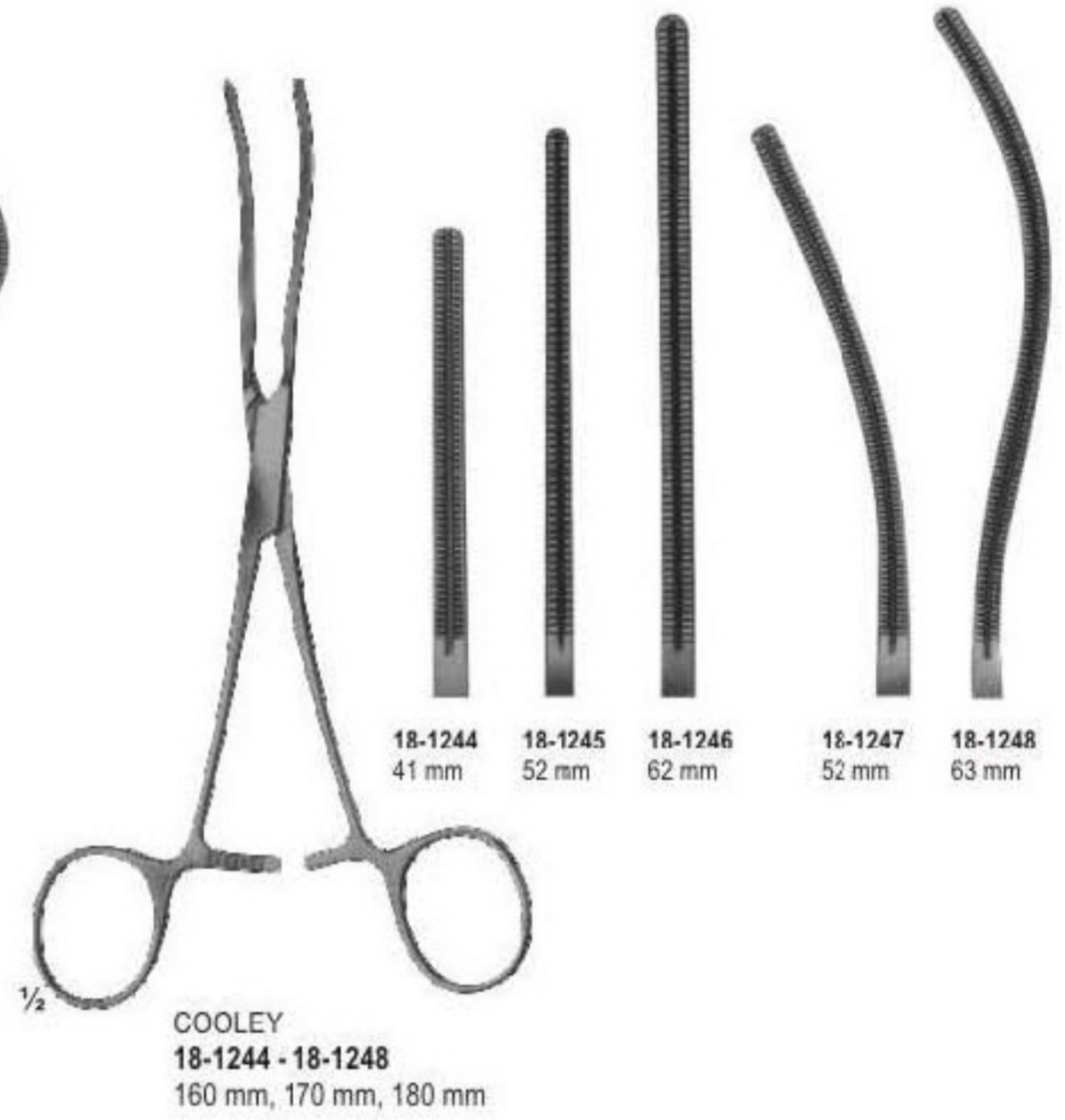
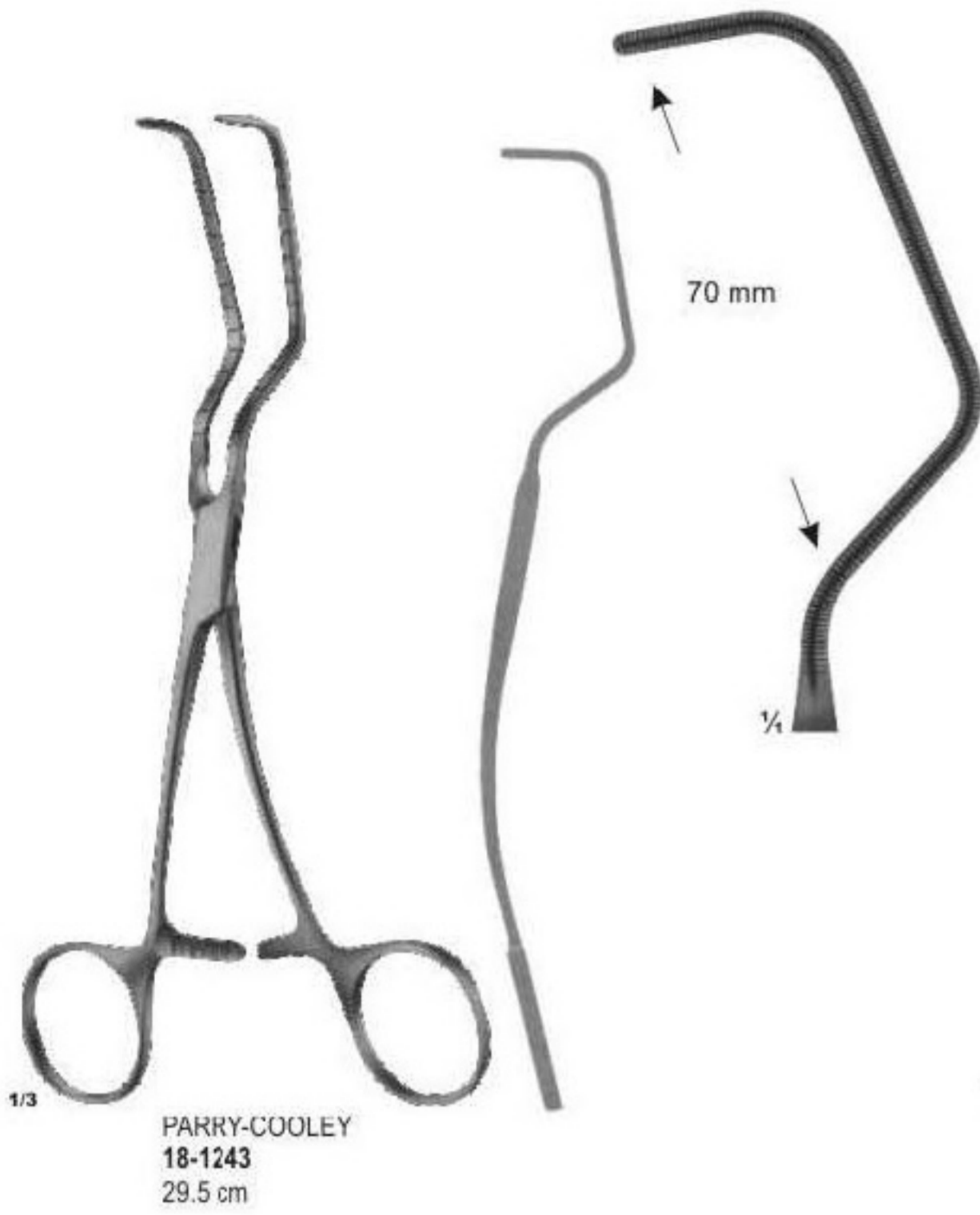

Multi-purpose Clamps

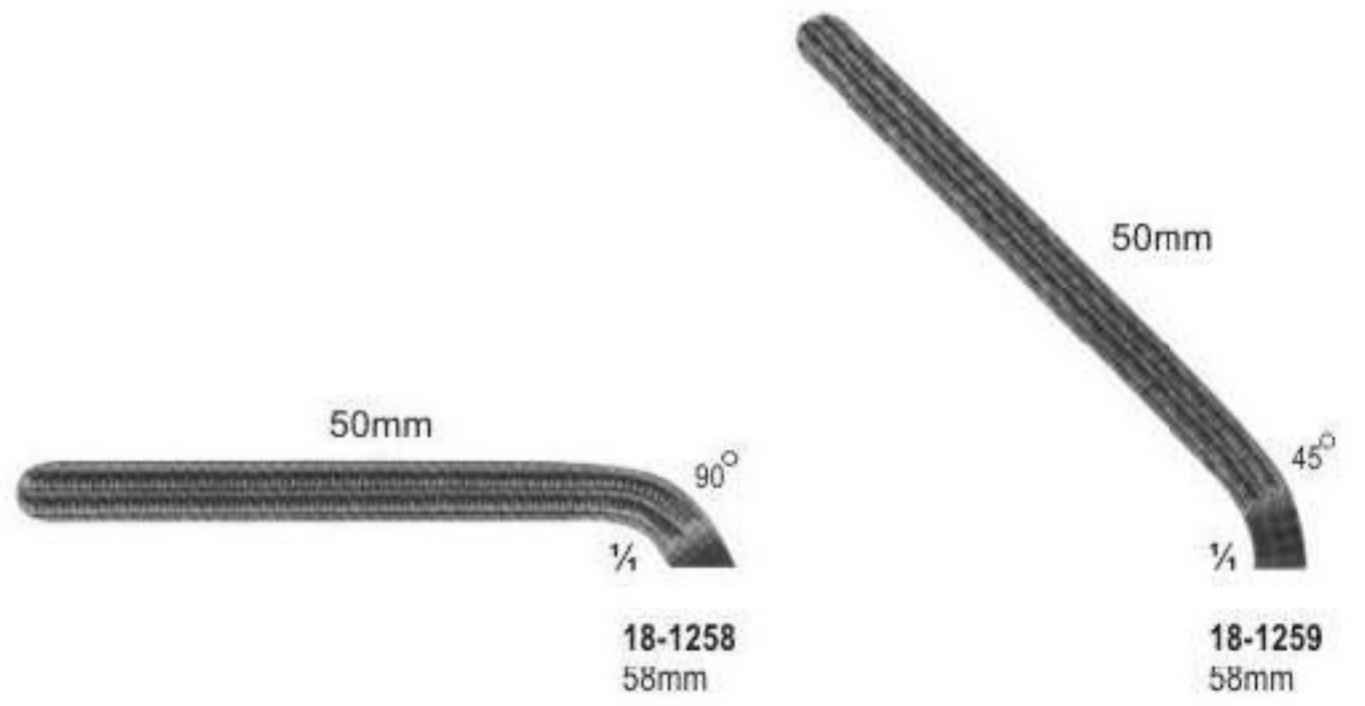
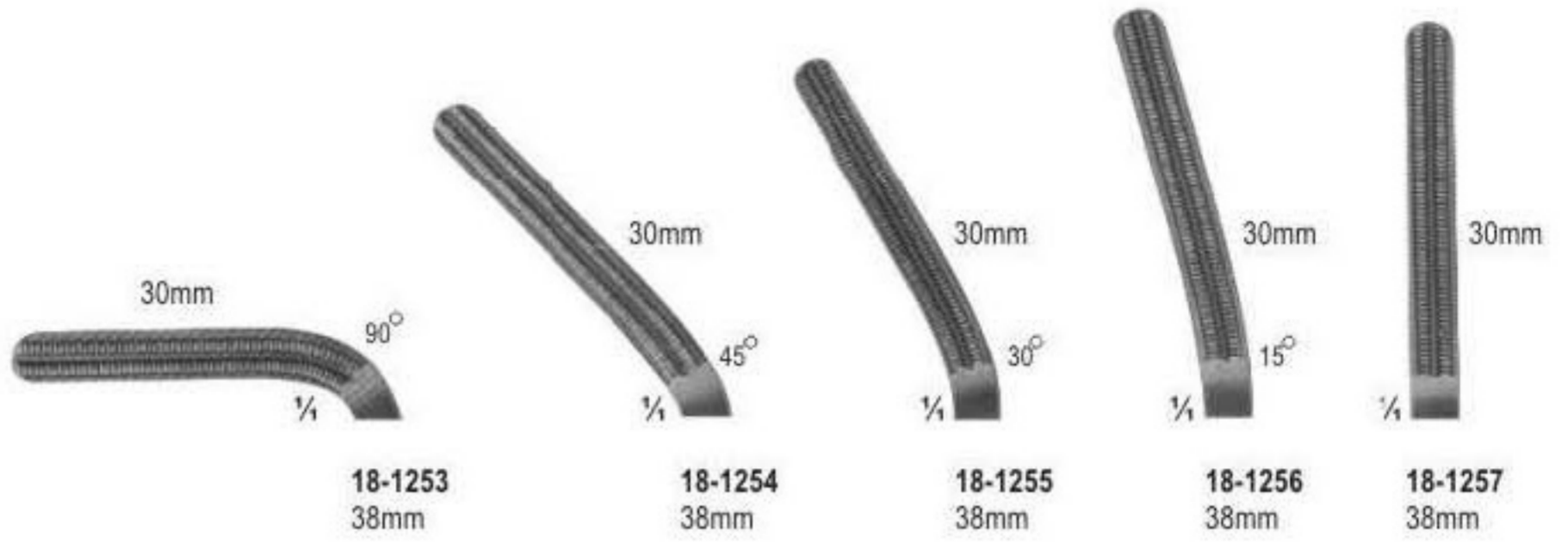

DARDIK

18-1253 15 cm	18-1258 17 cm
18-1254 15 cm	18-1259 17 cm
18-1255 15 cm	18-1260 17 cm
18-1256 14.5 cm	18-1261 16 cm
18-1257 13 cm	18-1262 13.5 cm

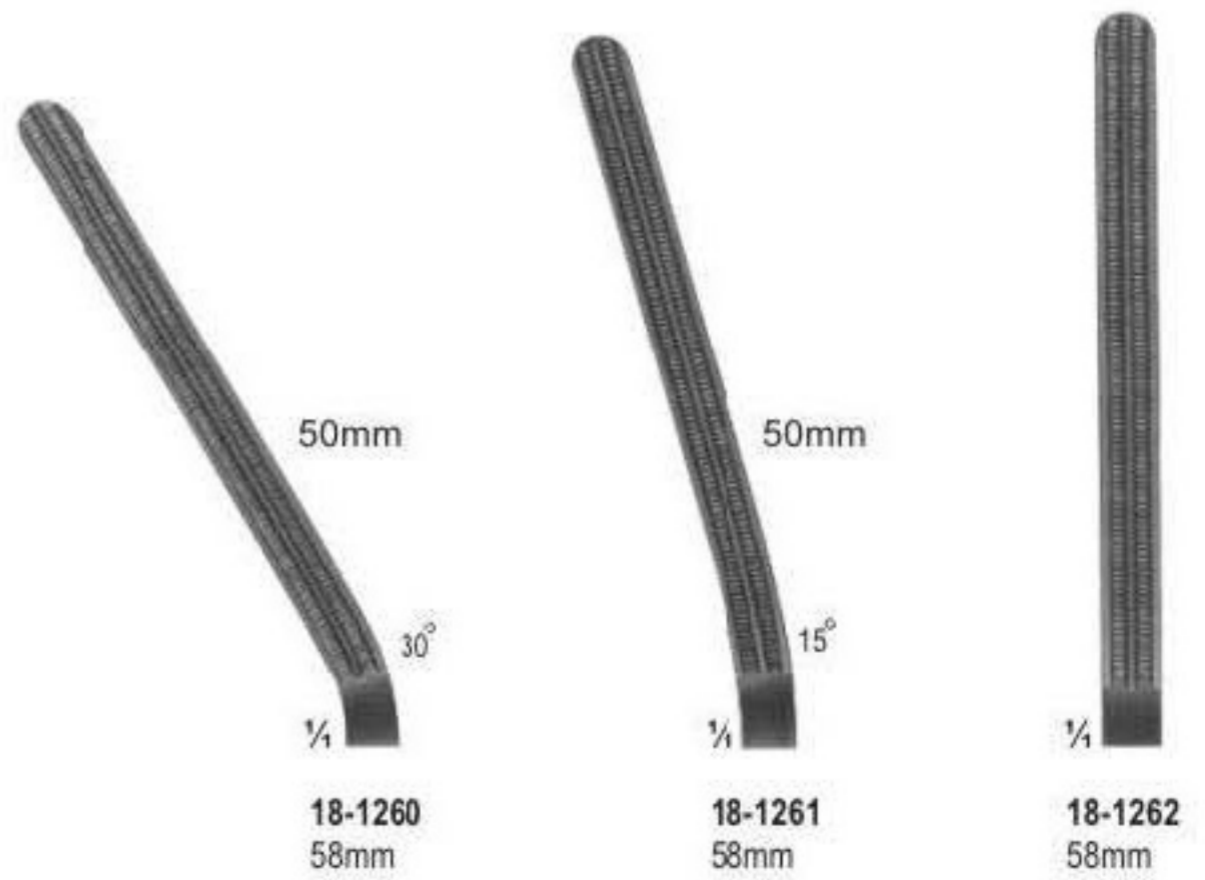

Peripheral Vascular Clamps

ATRAUMA



DALE
18-1263
18 cm



DALE
18-1264 - 18-1266



18-1264
17.5 cm

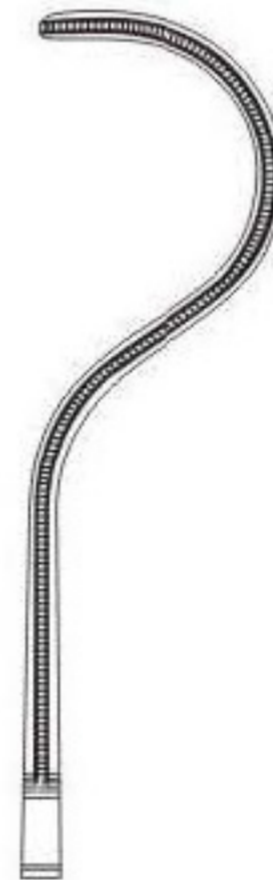

18-1265
18 cm



18-1266
18.5 cm

Catheter Clamps

ATRAUMA

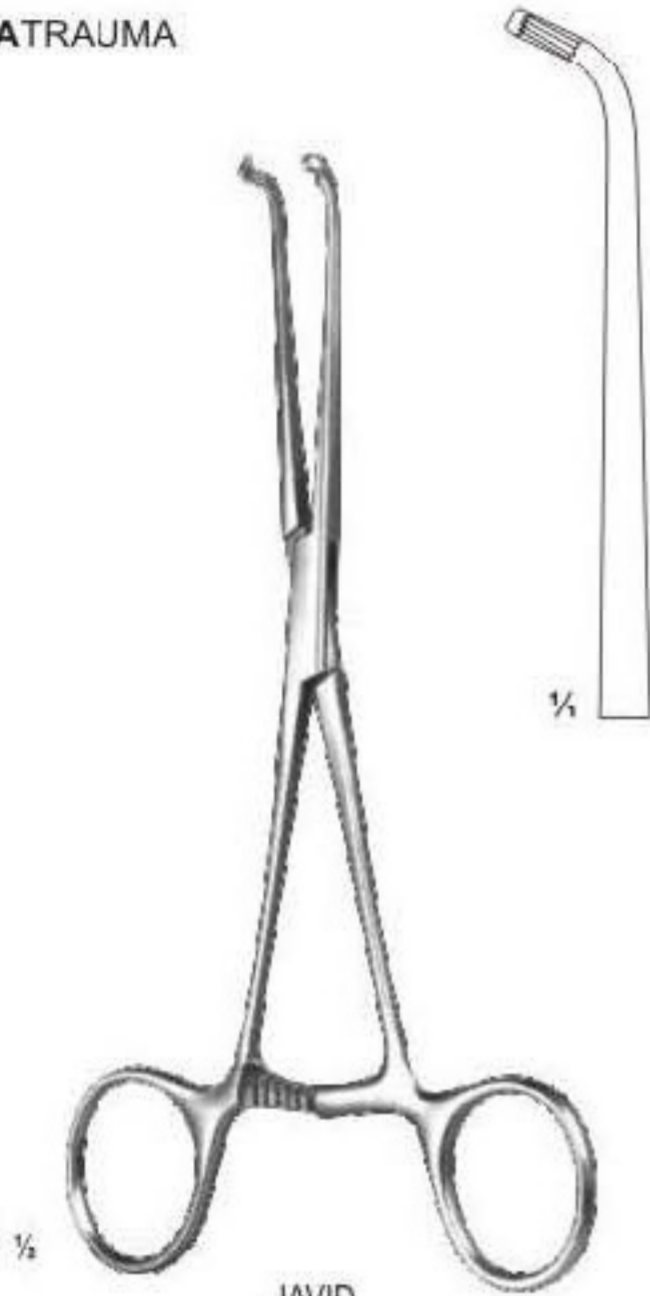

JAVID
18-1273
17.5 cm

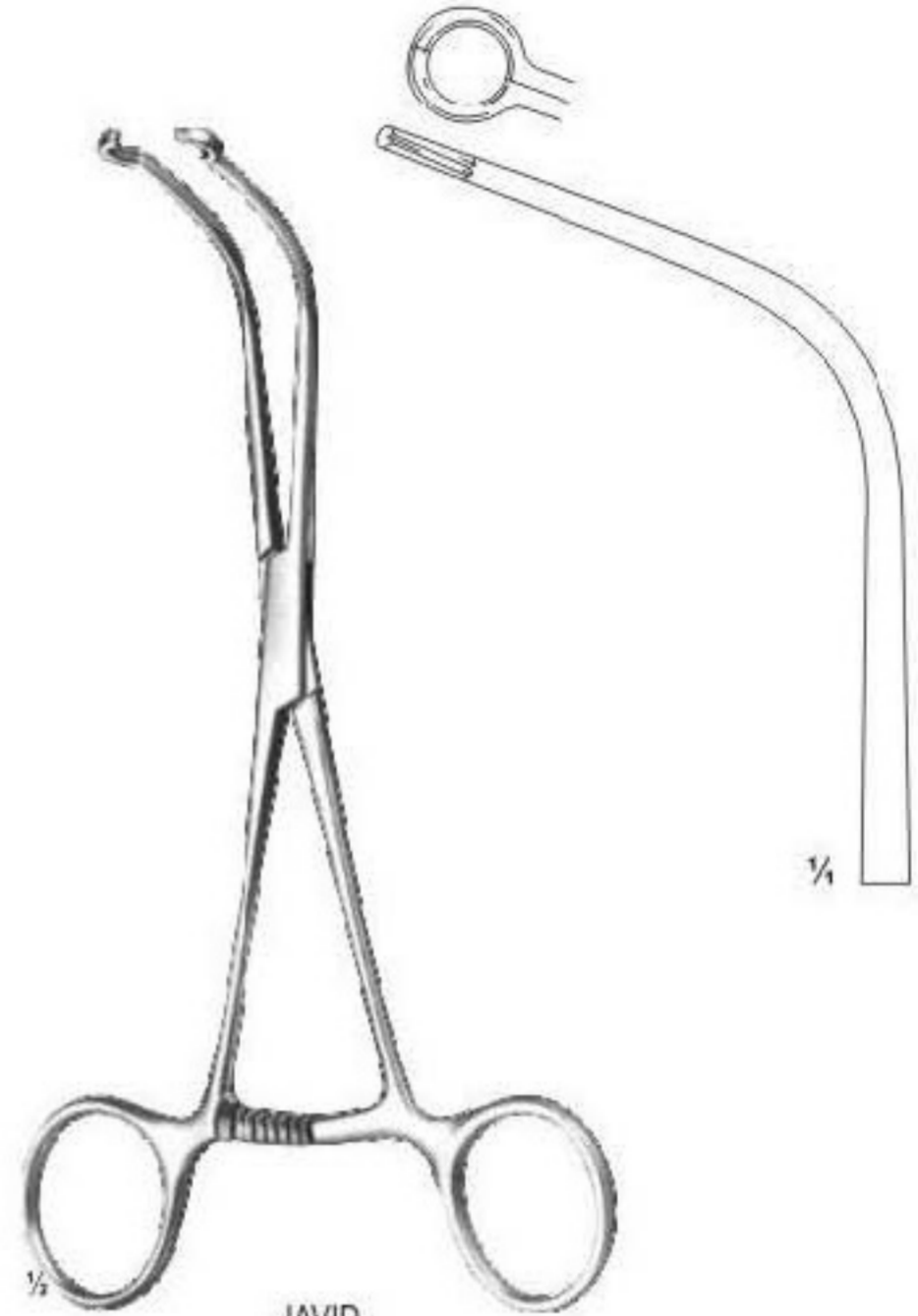

JAVID
18-1274
18.5 cm

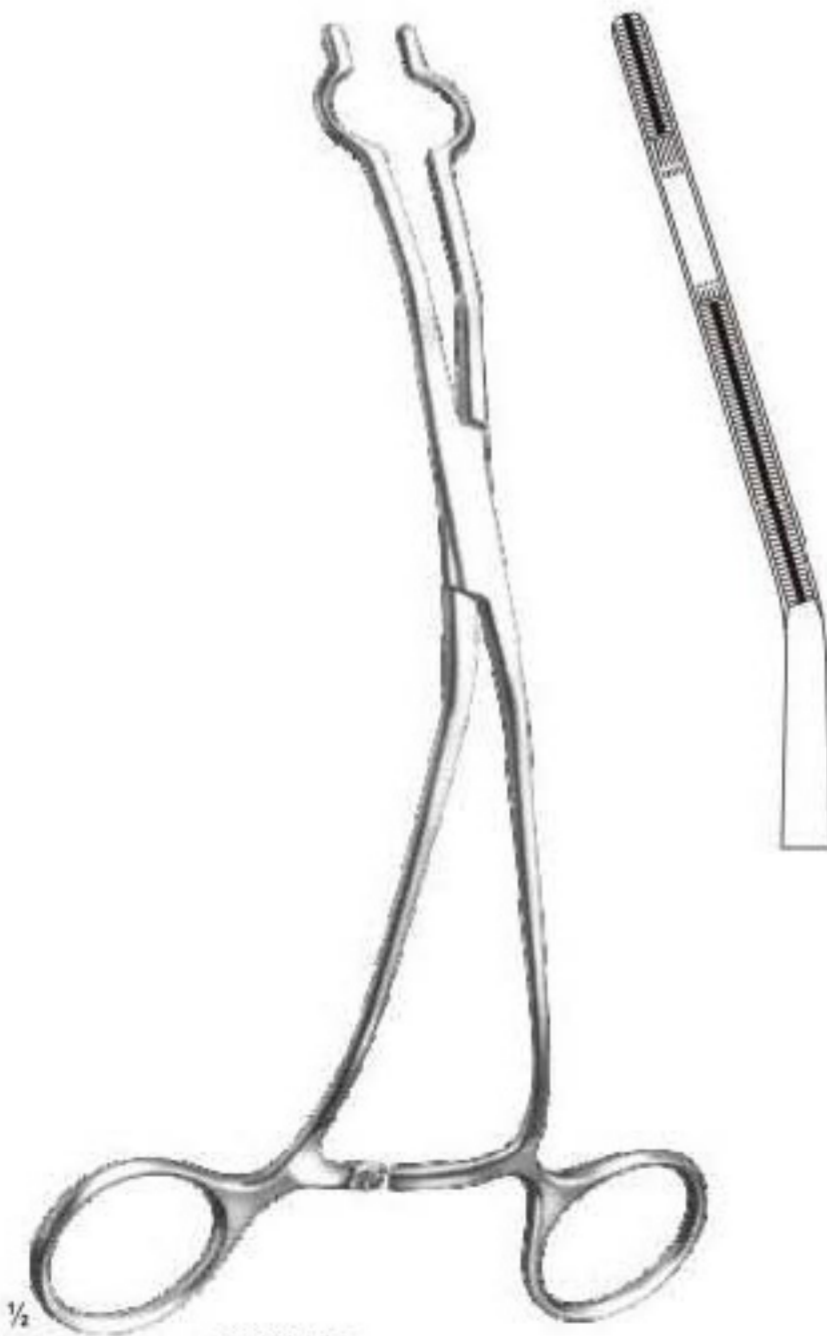

COOLEY
18-1275 - 18-1280



1/2
18-1275
17 cm



1/2
18-1276
17 cm



1/2
18-1277
20 cm



1/2
18-1278
20 cm



1/2
18-1279
20 cm

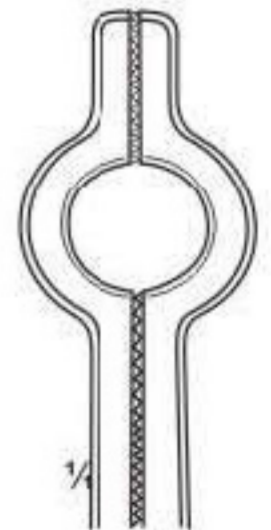

1/2
18-1280
20 cm

Profunda And Peripheral Vascular Clamps

ATRAUMA



GREGORY
18-1267 - 18-1269

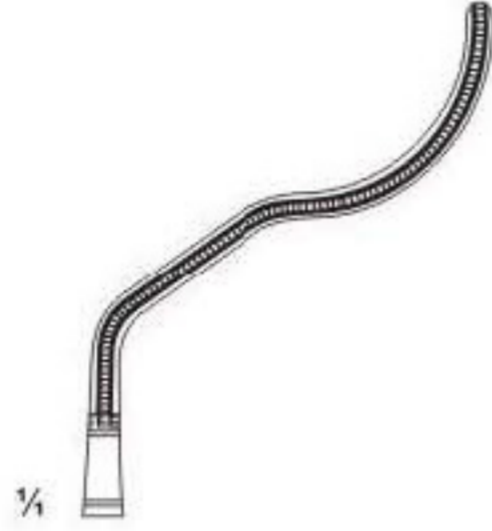

18-1267
13.5 cm

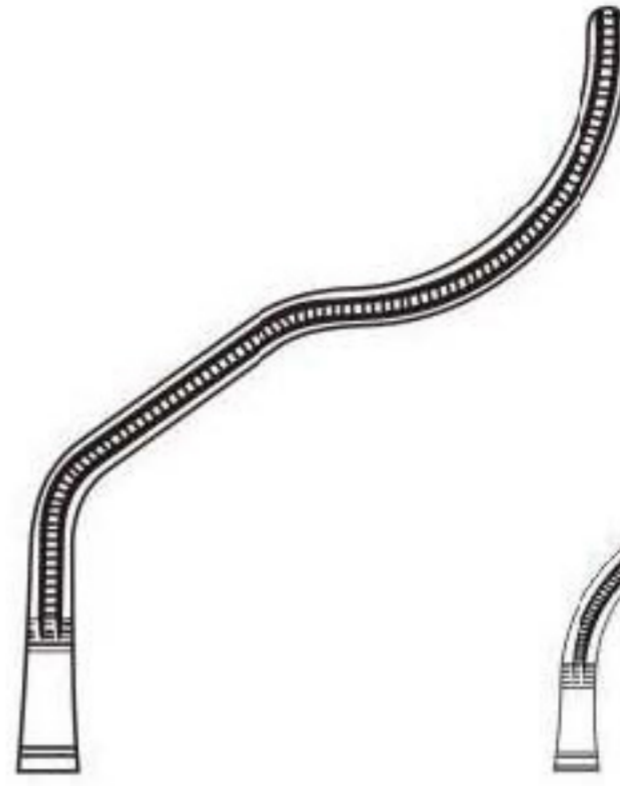

18-1268
16 cm



18-1269
18 cm

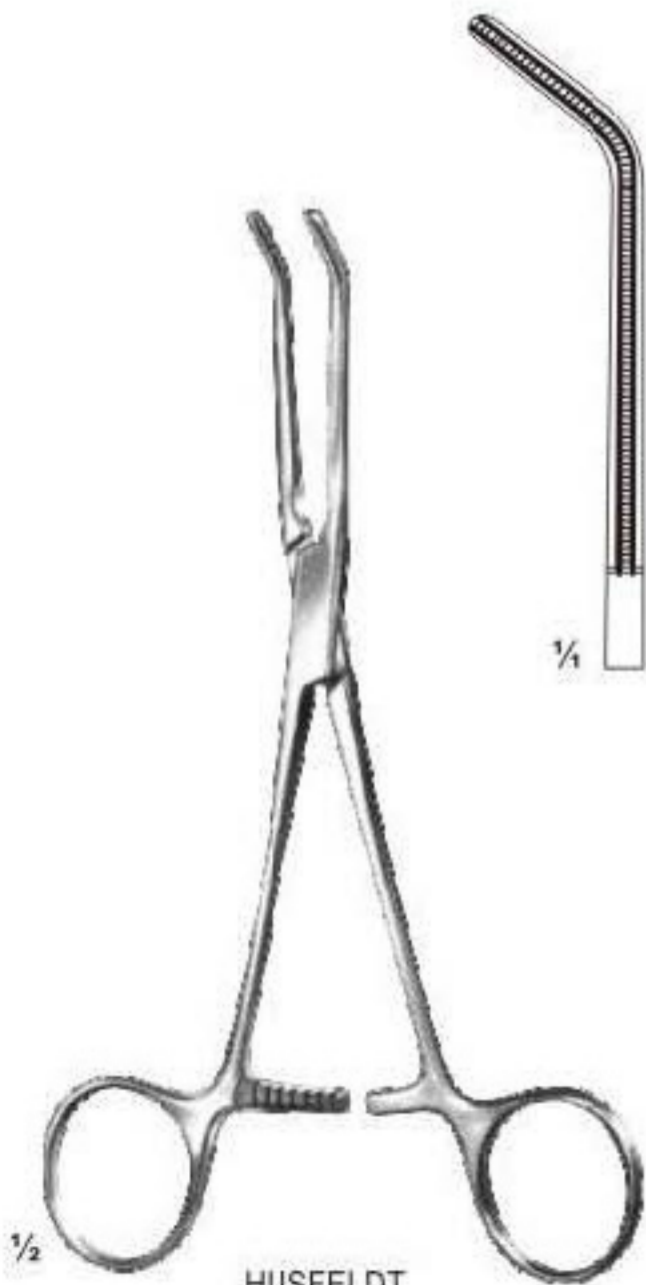

HUSFELDT
18-1270
16.5 cm

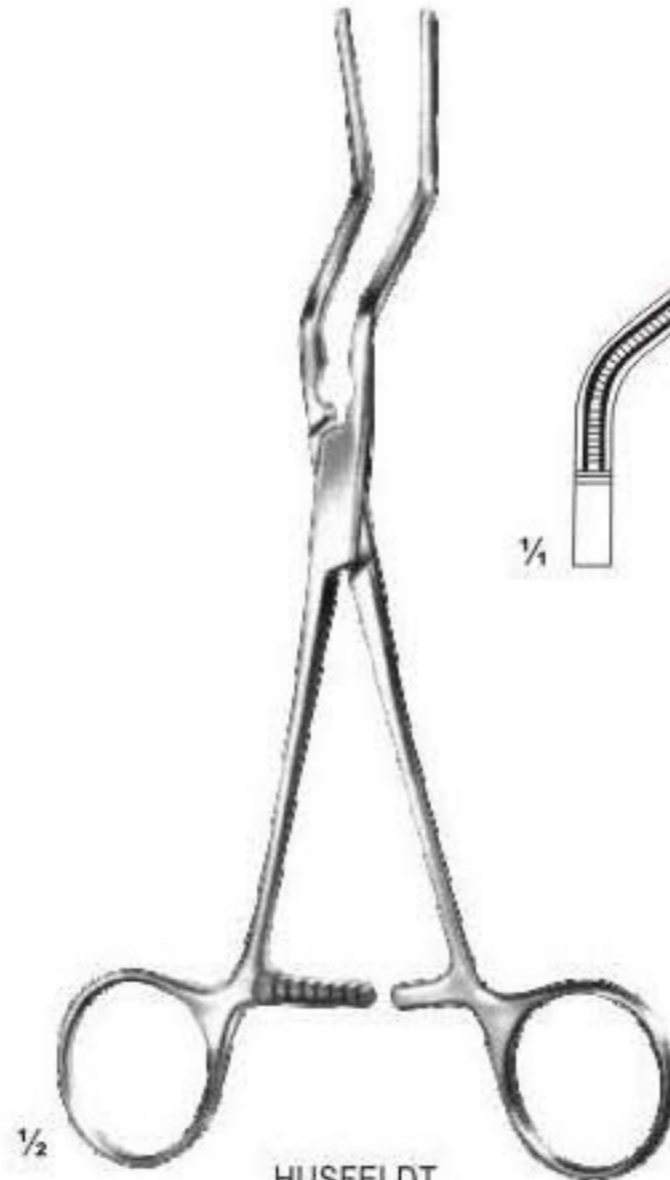

HUSFELDT
18-1271
18 cm

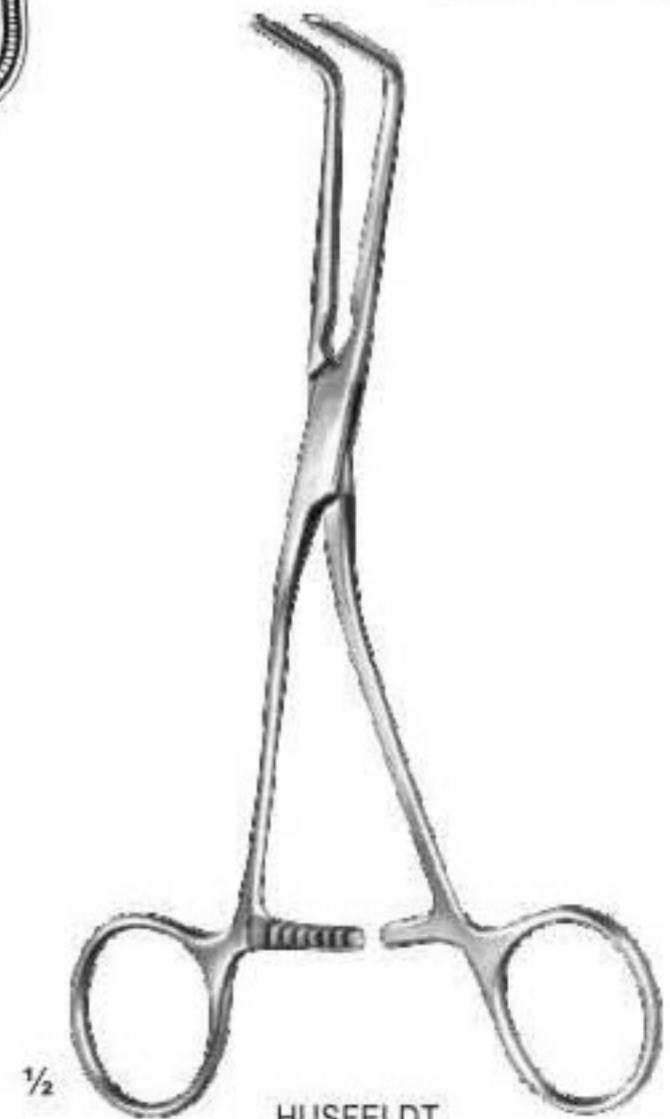

HUSFELDT
18-1272
17 cm

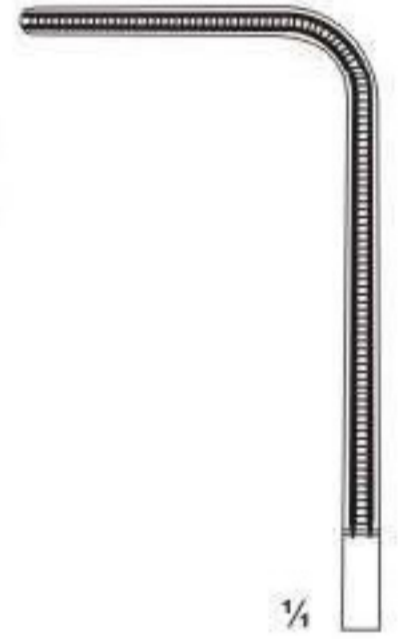

Aorta-anastomosis Clamps

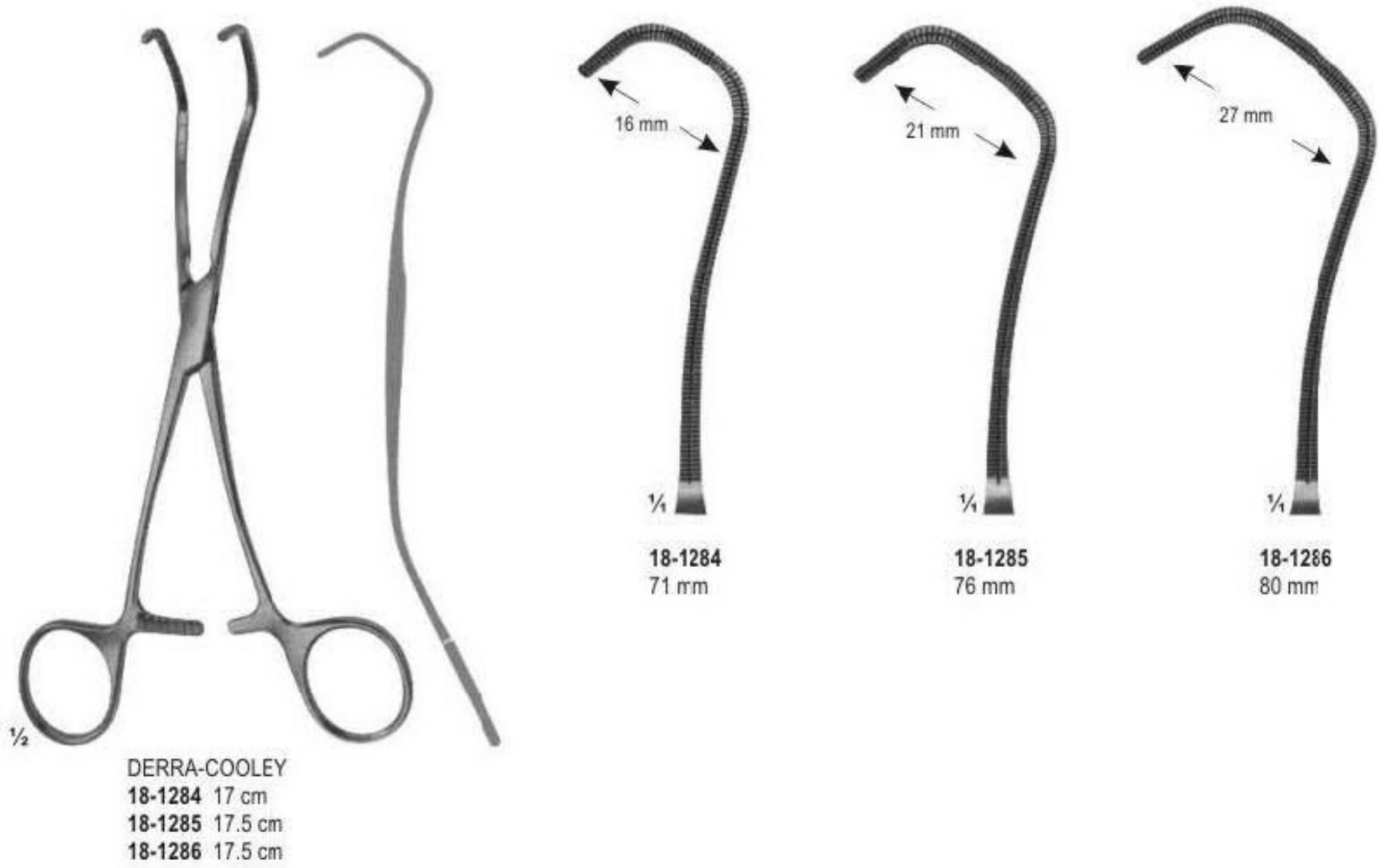
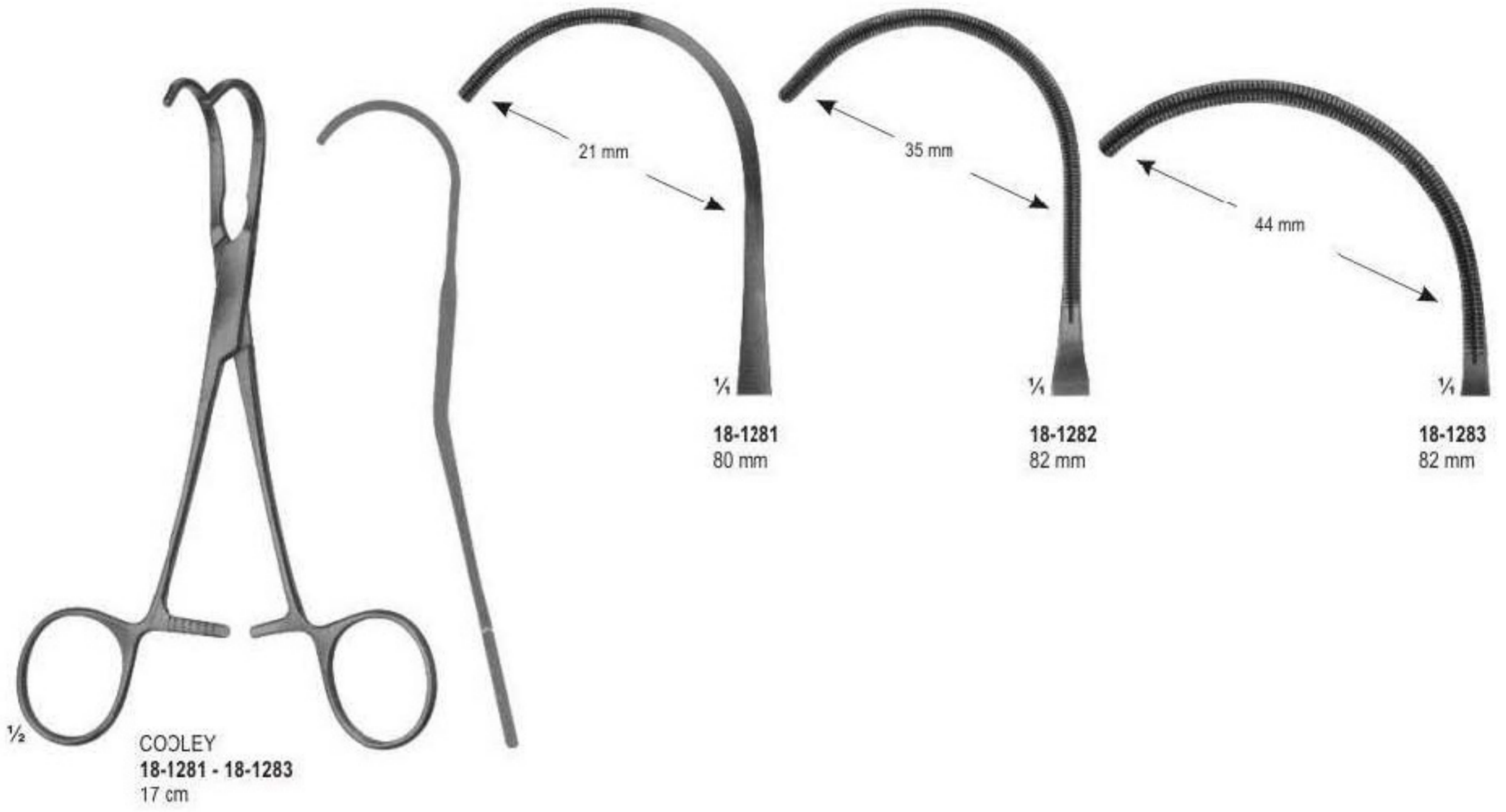

Aortic Clamps

ATRAUMA



WYLIE
18-1287
24 cm

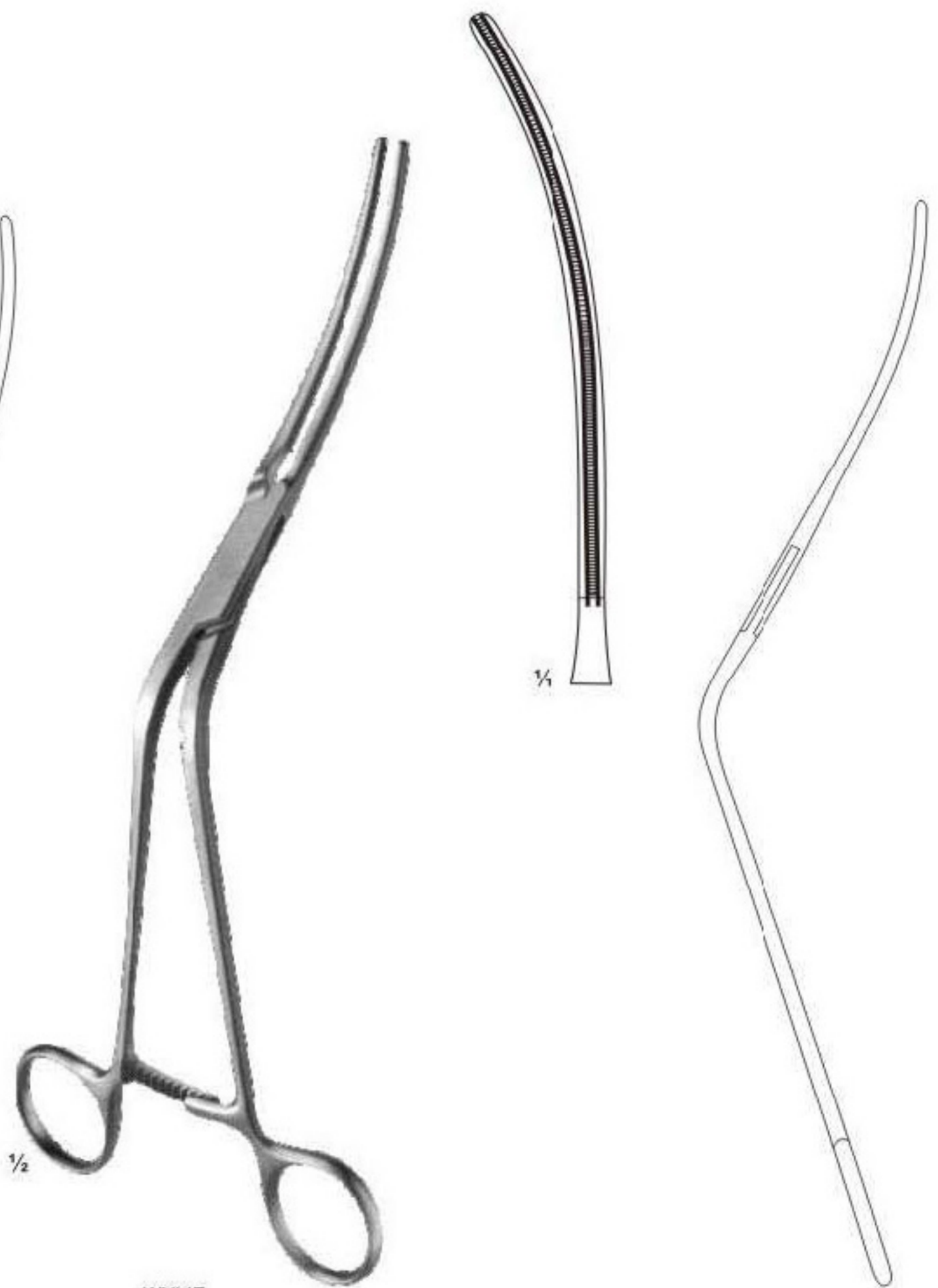

WYLIE
18-1288
27 cm

Coarctation Clamps

ATRAUMA

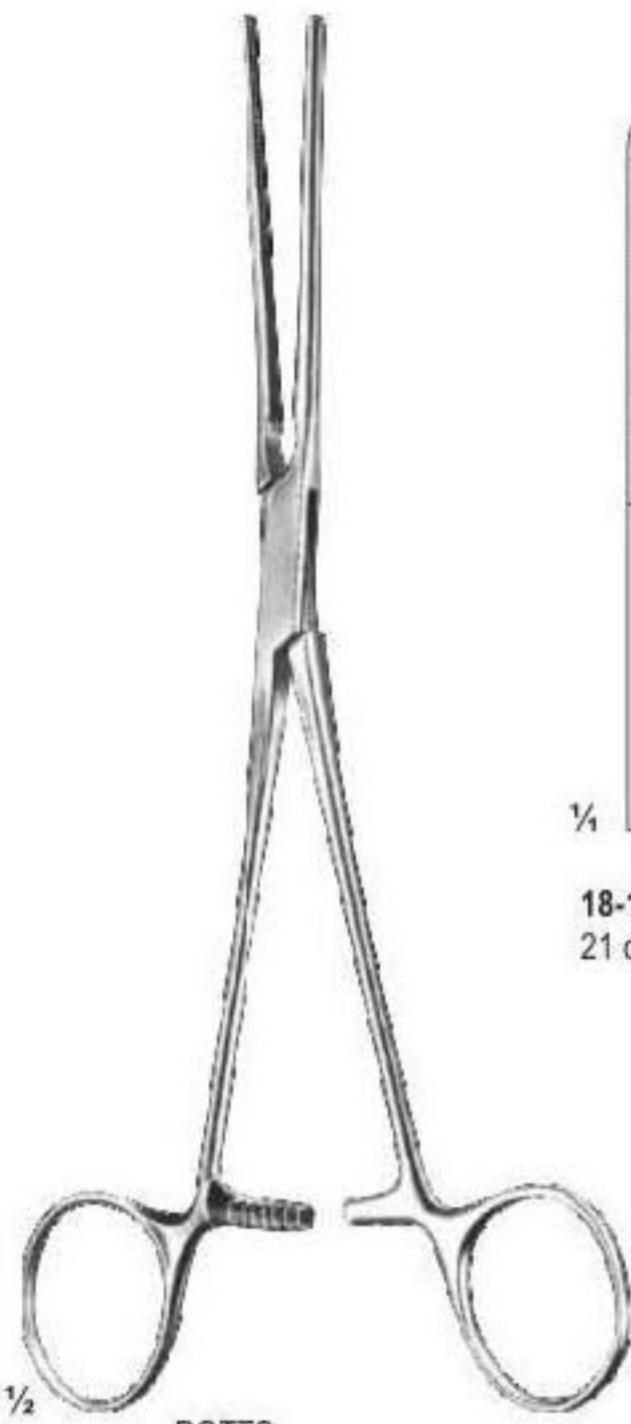

$\frac{1}{2}$
POTTS
18-1289 - 18-1290



$\frac{1}{4}$
18-1289
21 cm



18-1290
22.5 cm



$\frac{1}{2}$
POTTS
18-1291 - 18-1292



$\frac{1}{4}$
18-1291
20 cm



18-1292
22 cm



$\frac{1}{2}$
POTTS
18-1293 - 18-1294



$\frac{1}{4}$
18-1293
20.5 cm



18-1294
22 cm



Aorta-anastomosis Clamps



18-1295
50mm

18-1296
50mm

COOLEY
18-1295 12.5 cm
18-1296 11.5 cm



COOLEY
18-1297
10 cm

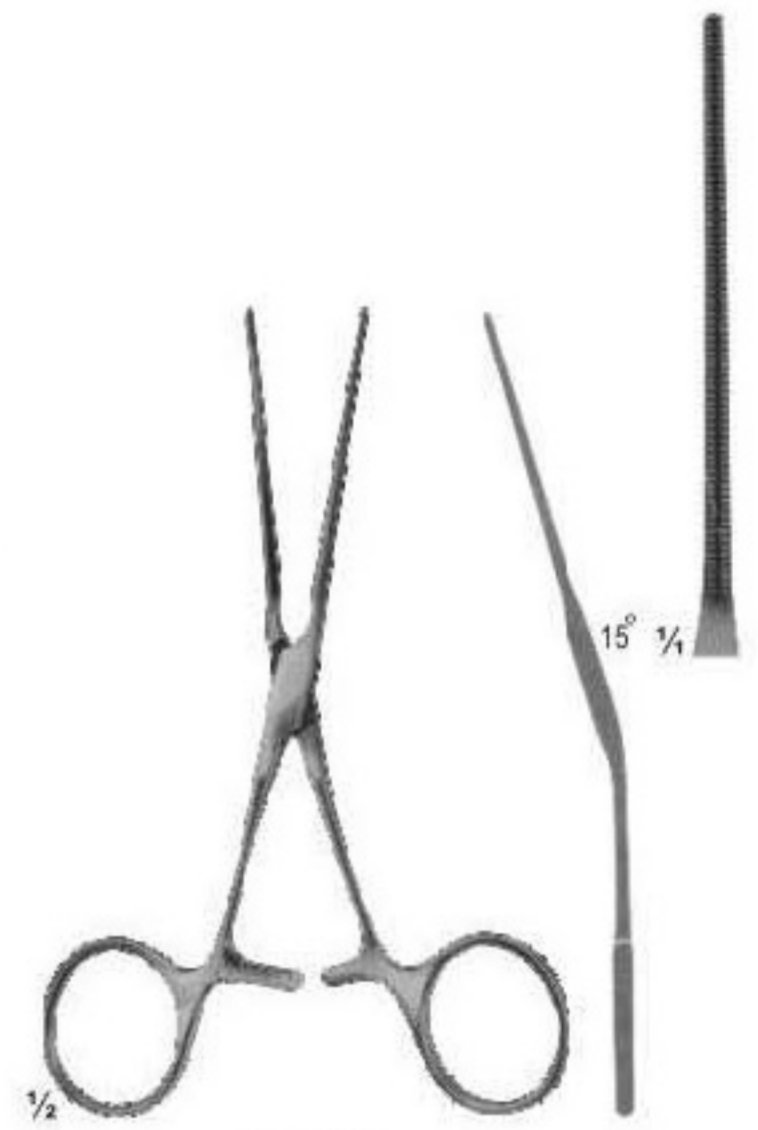

COOLEY
18-1298
12.5 cm

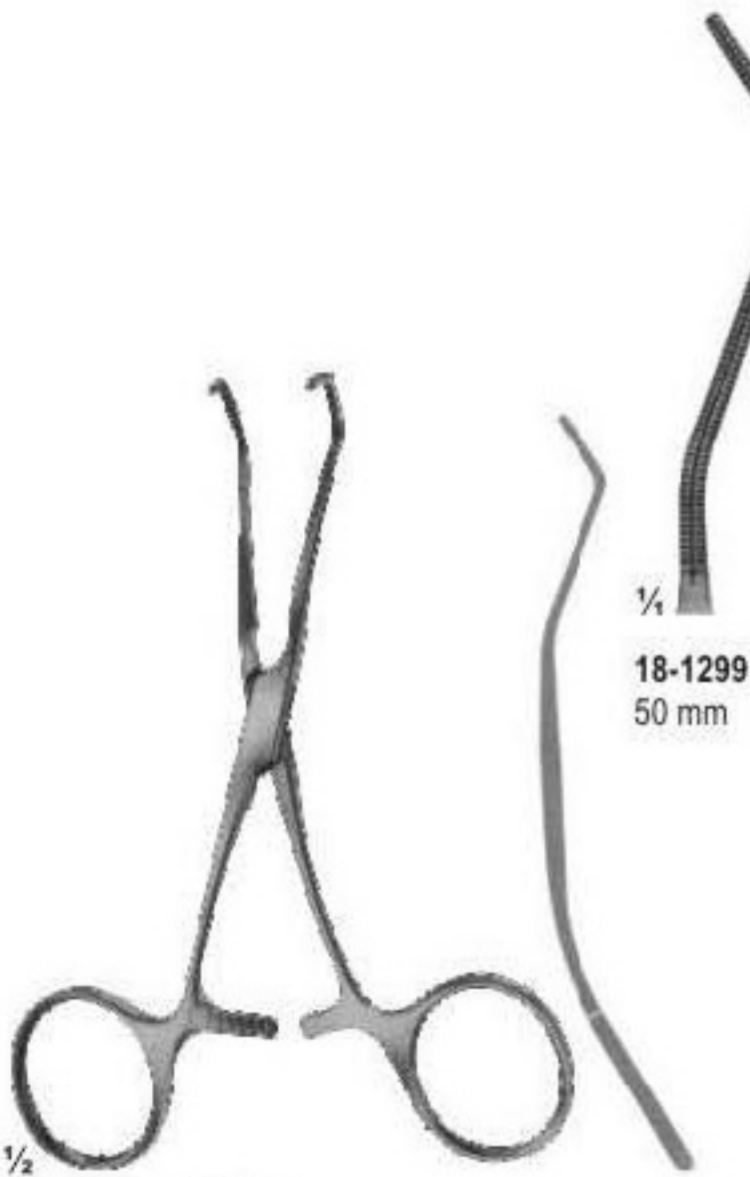

18-1299
50 mm



18-1300
50 mm

COOLEY
18-1299 12 cm
18-1300 11.5 cm

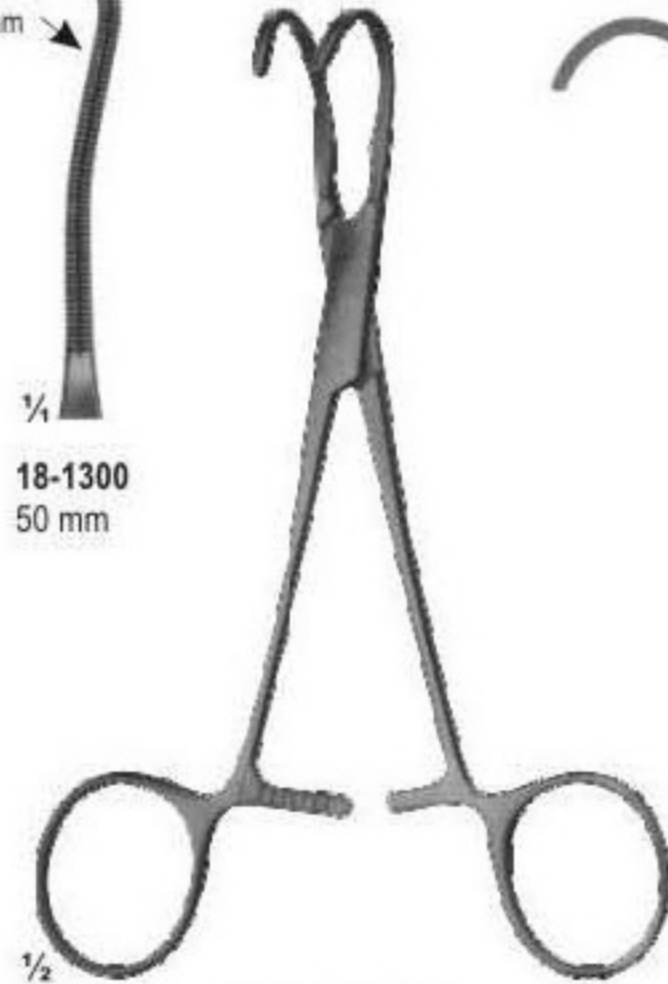

18-1301
56 mm

COOLEY-BACK
18-1301 15 cm
18-1302 11.5 cm

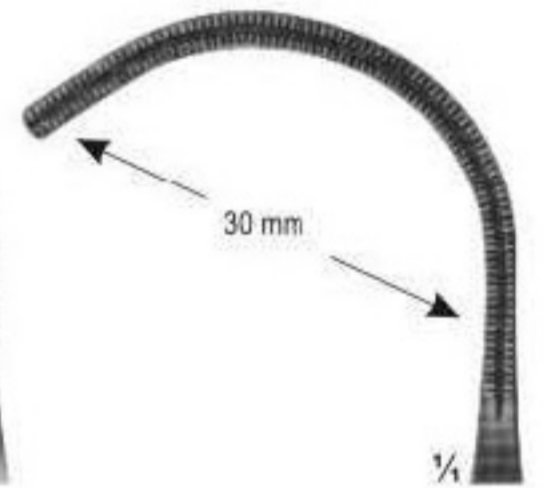

18-1302
63 mm

Anastomosis And Multi Purpose Vascular Clamps

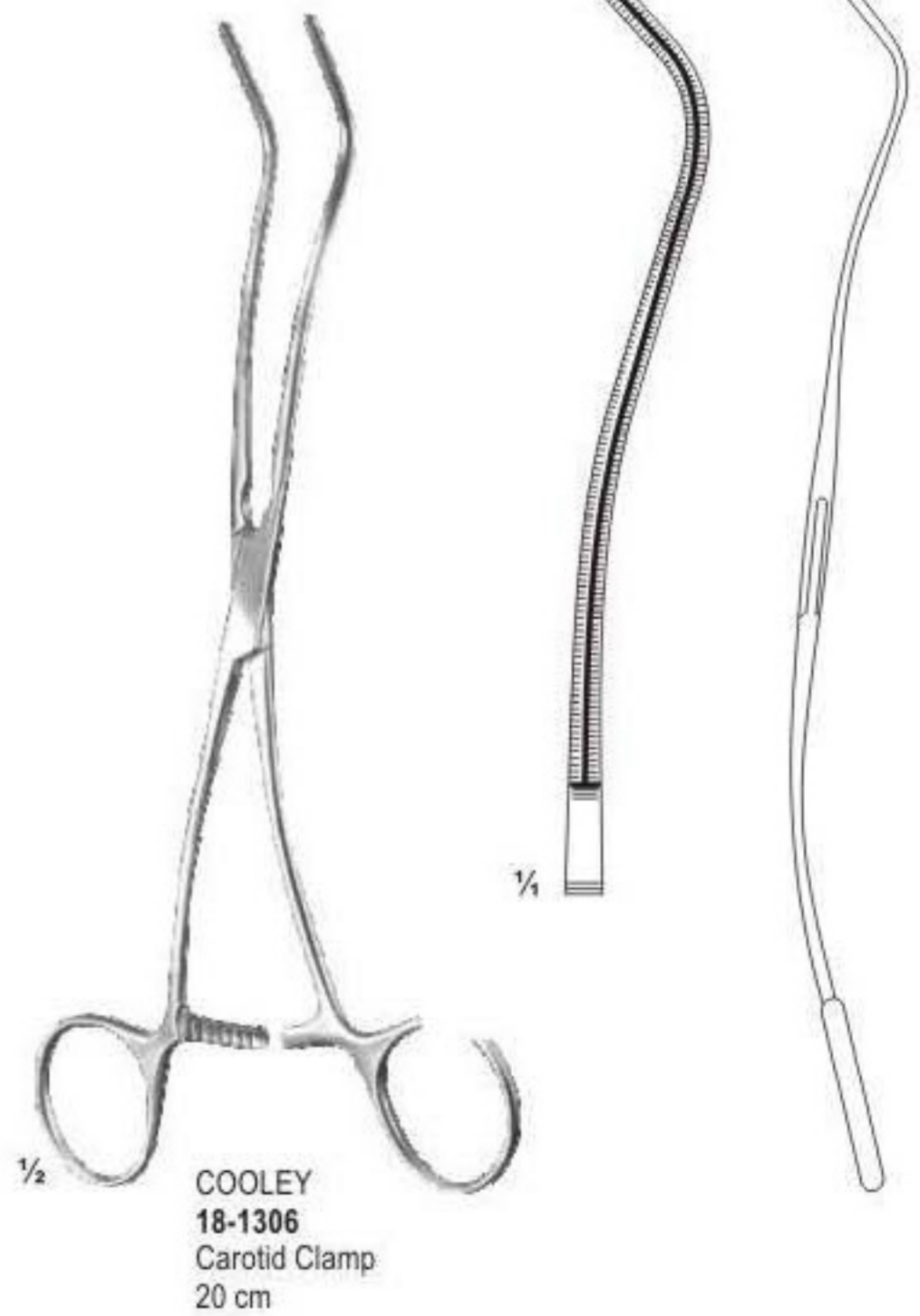
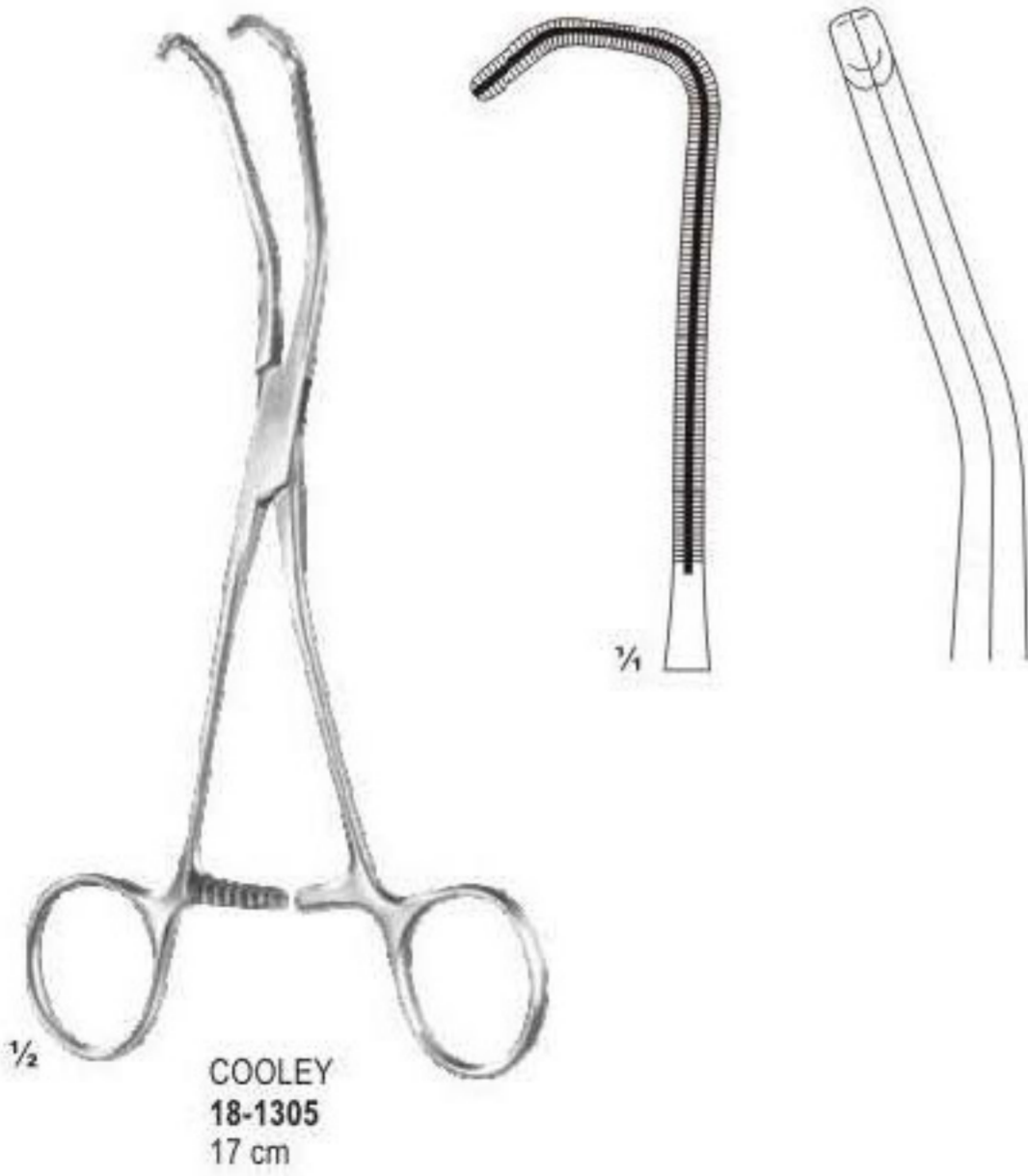

Aorta-anastomosis Clamps

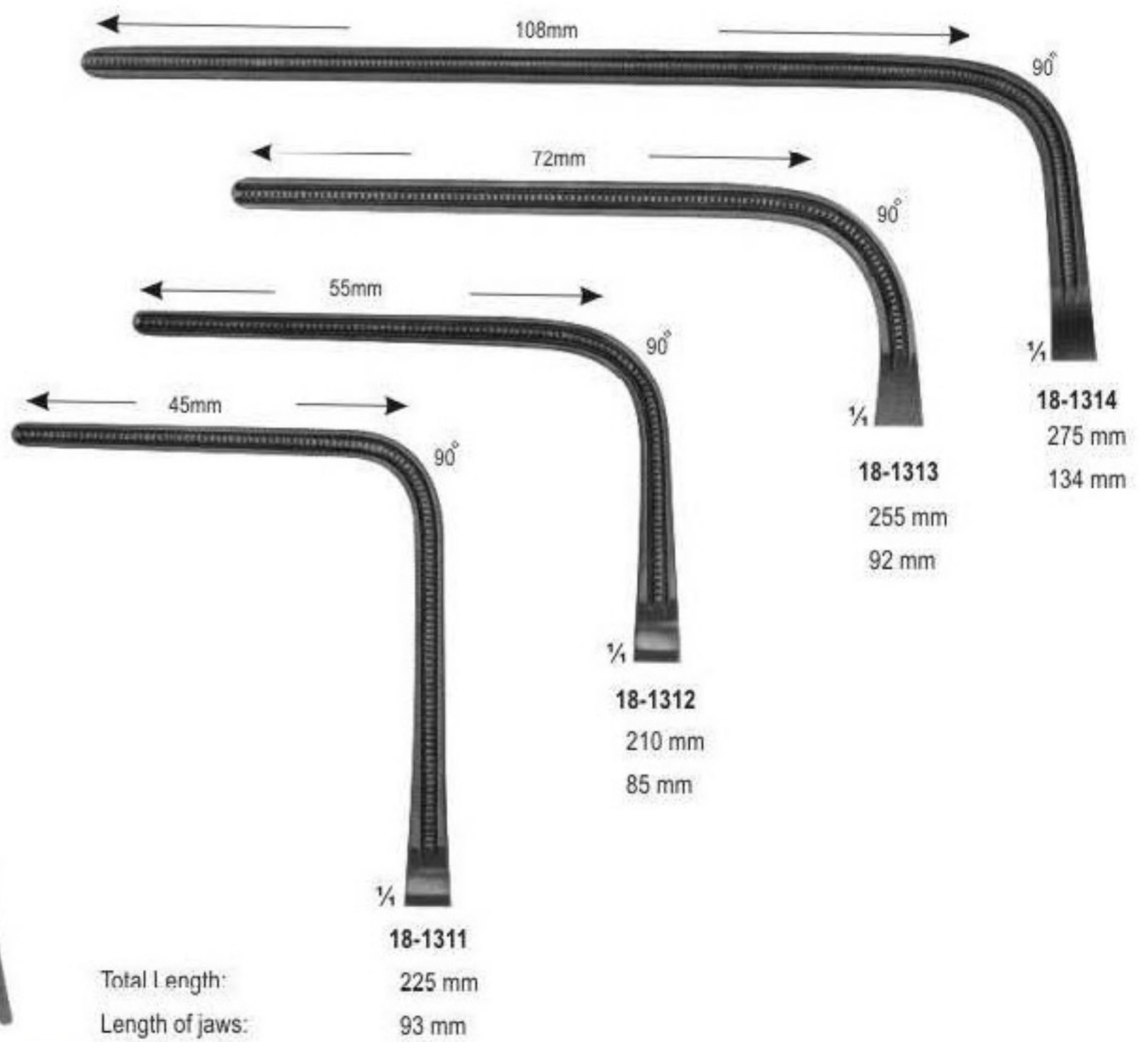
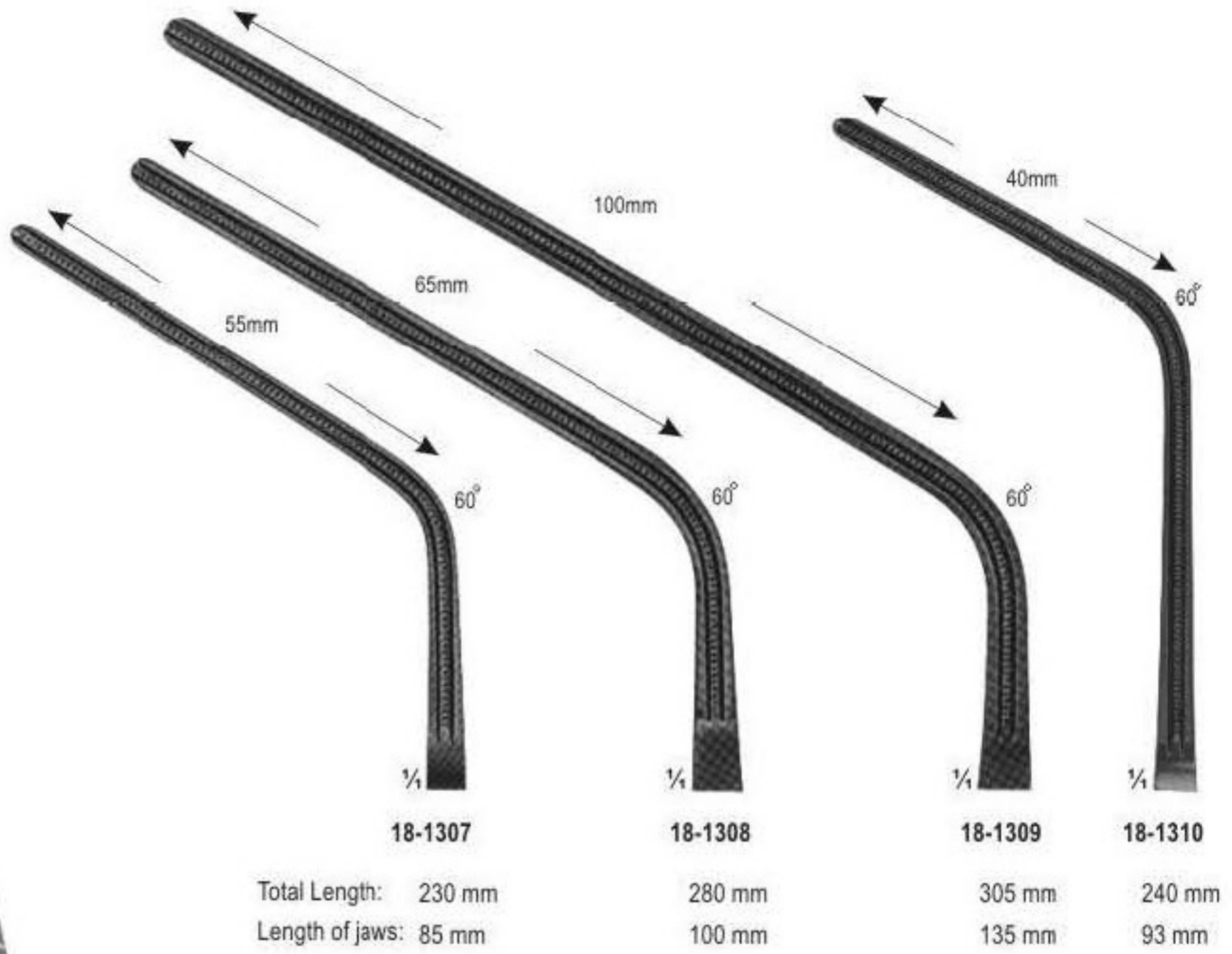

Multi Purpose Vascular Clamps



DE BAKEY
18-1315
15 cm



DE BAKEY
18-1316
16.5 cm



GLOVER
18-1317
17 cm

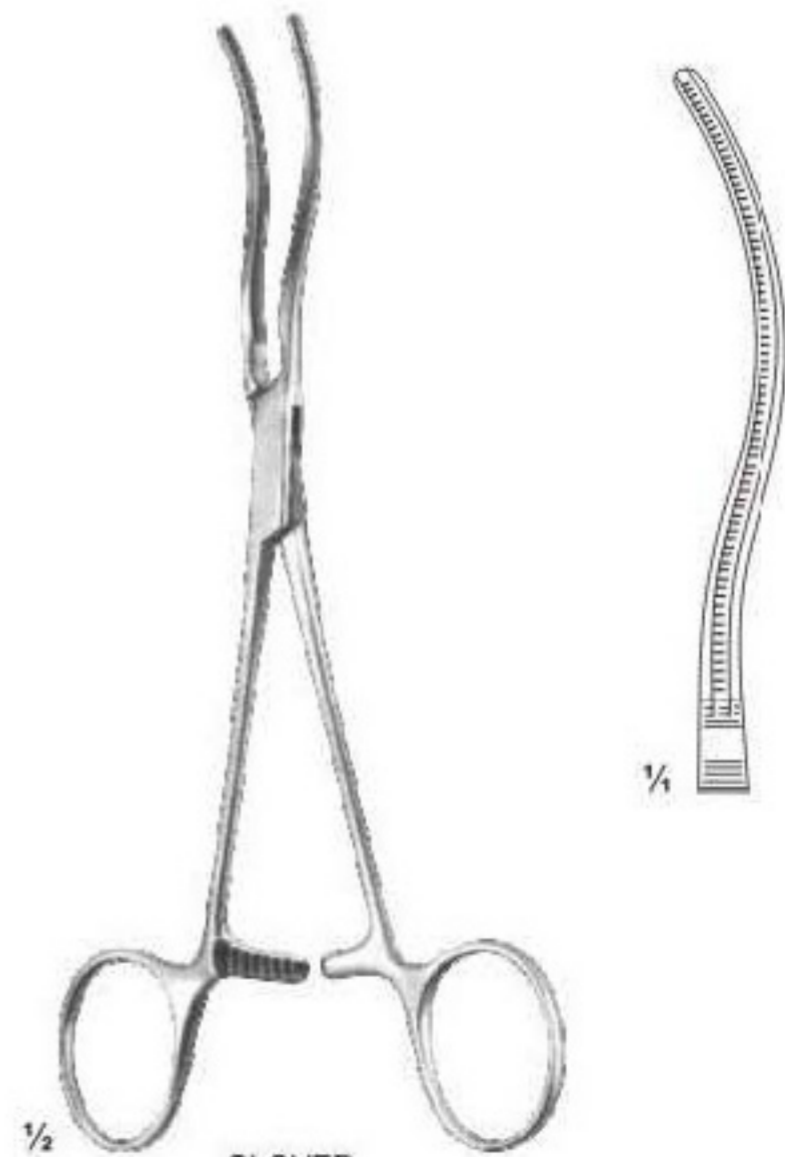

GLOVER
18-1318
17.5 cm

Page 554-564



- Retractors For Cervical Vertebral Column
- Vacuum Currettes For Aspiration Lipectomy, Suction Instruments
- Suction Instruments
- Combined Section & Irrigation Cannula



Retractors For Cervical Vertebral Column

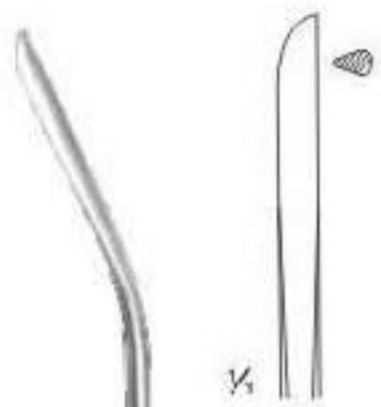

- 19-1001 8 CH
- 19-1002 10 CH
- 19-1003 12 CH
- 19-1004 14 CH
- 19-1005 16 CH
- 19-1006 18 CH

1/2

REDON
19-1001 - 19-1006
threaded end
19.5 cm



- 19-1007 8 CH
- 19-1008 10 CH
- 19-1009 12 CH
- 19-1010 14 CH
- 19-1011 16 CH
- 19-1012 18 CH

1/2

REDON
19-1007 - 19-1012
threaded end
14 cm

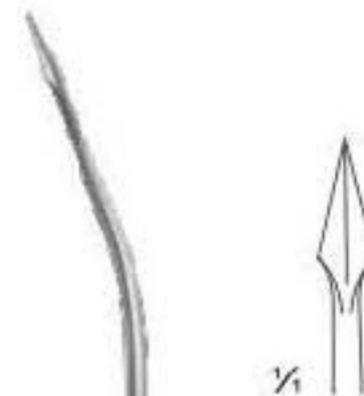

- 19-1013 8 CH
- 19-1014 10 CH
- 19-1015 12 CH
- 19-1016 14 CH
- 19-1017 16 CH
- 19-1018 18 CH

1/2

REDON
19-1013 - 19-1018
threaded end
19.5 cm

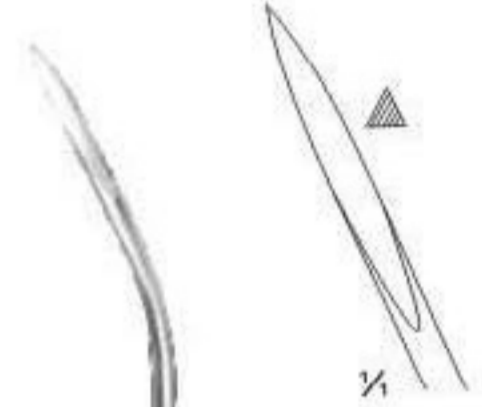

- 19-1019 8 CH
- 19-1020 10 CH
- 19-1021 12 CH
- 19-1022 14 CH
- 19-1023 16 CH
- 19-1024 18 CH

1/2

REDON
19-1019 - 19-1024
threaded end
19.5 cm

Retractors For Cervical Vertebral Column



1/2

WULLSTEIN
19-1025 - 19-1027
14 cm
handle with tube, only



WULLSTEIN
19-1025
4.5 cm
Micro Suction Cannula
Complete, with handle and 3 tips
Ø 0.4 mm



WULLSTEIN
19-1026
4.5 cm
Micro Suction Cannula
Complete, with handle and 3 tips
Ø 0.6 mm



WULLSTEIN
19-1027
4.5 cm
Micro Suction Cannula
Complete, with handle and 3 tips
Ø 0.8 mm



1/2

BARON-SCHUKNECHT
19-1028 - 19-1030
with finer cut-off



19-1028
working length 75 mm
Ø 1 mm



19-1029
working length 75 mm
Ø 1.5 mm



19-1030
working length 75 mm
Ø 2 mm



1/2

ZOELLNER
19-1031 - 19-1034
Suction Cannula

Suction Tip

19-1031	Ø 0.5 mm
19-1032	Ø 0.7 mm
19-1033	Ø 0.9 mm
19-1034	Ø 1.2 mm

Retractors For Cervical Vertebral Column

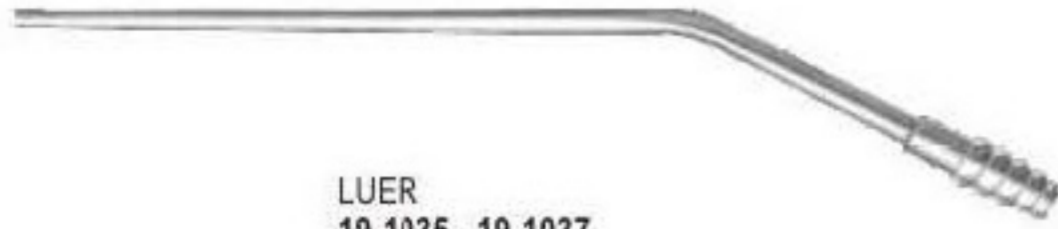

LUER
19-1035 - 19-1037
Conical

1/2



19-1035
16.5 cm
∅ 3 mm
working length
110 mm

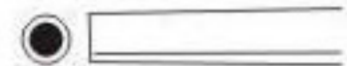

19-1036
16.5 cm
∅ 3.5 mm
working length
110 mm



19-1037
18 cm
∅ 4.5 mm
working length
130 mm



YASARGIL
19-1038 - 19-1041
working length
15 cm

1/2



19-1038
17 cm
∅ 1.5 mm



19-1039
17 cm
∅ 2 mm



19-1040
17 cm
∅ 2.5 mm

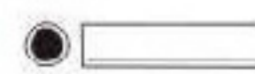

19-1041
17 cm
∅ 3.5 mm

Retractors For Cervical Vertebral Column

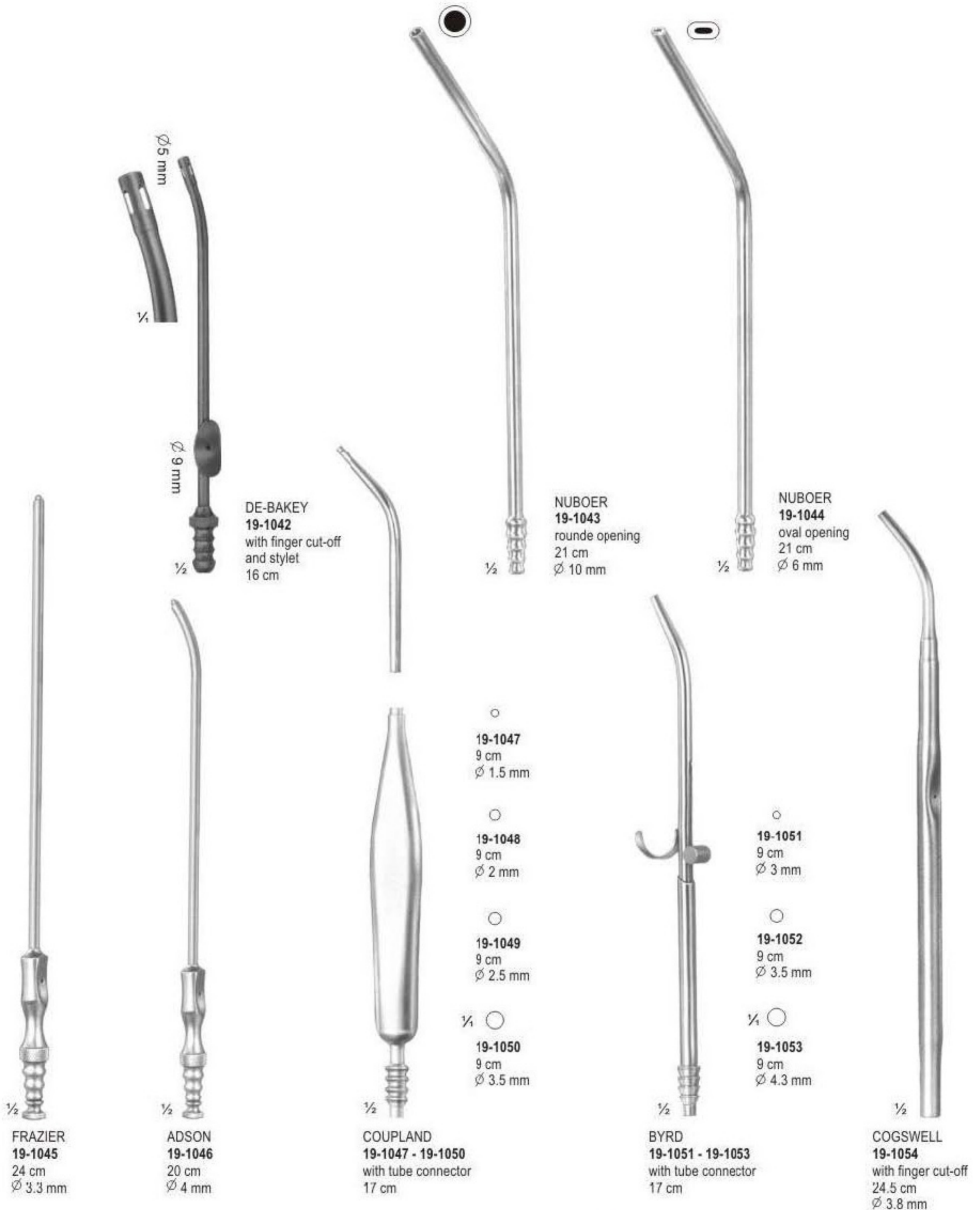

Retractors For Cervical Vertebral Column

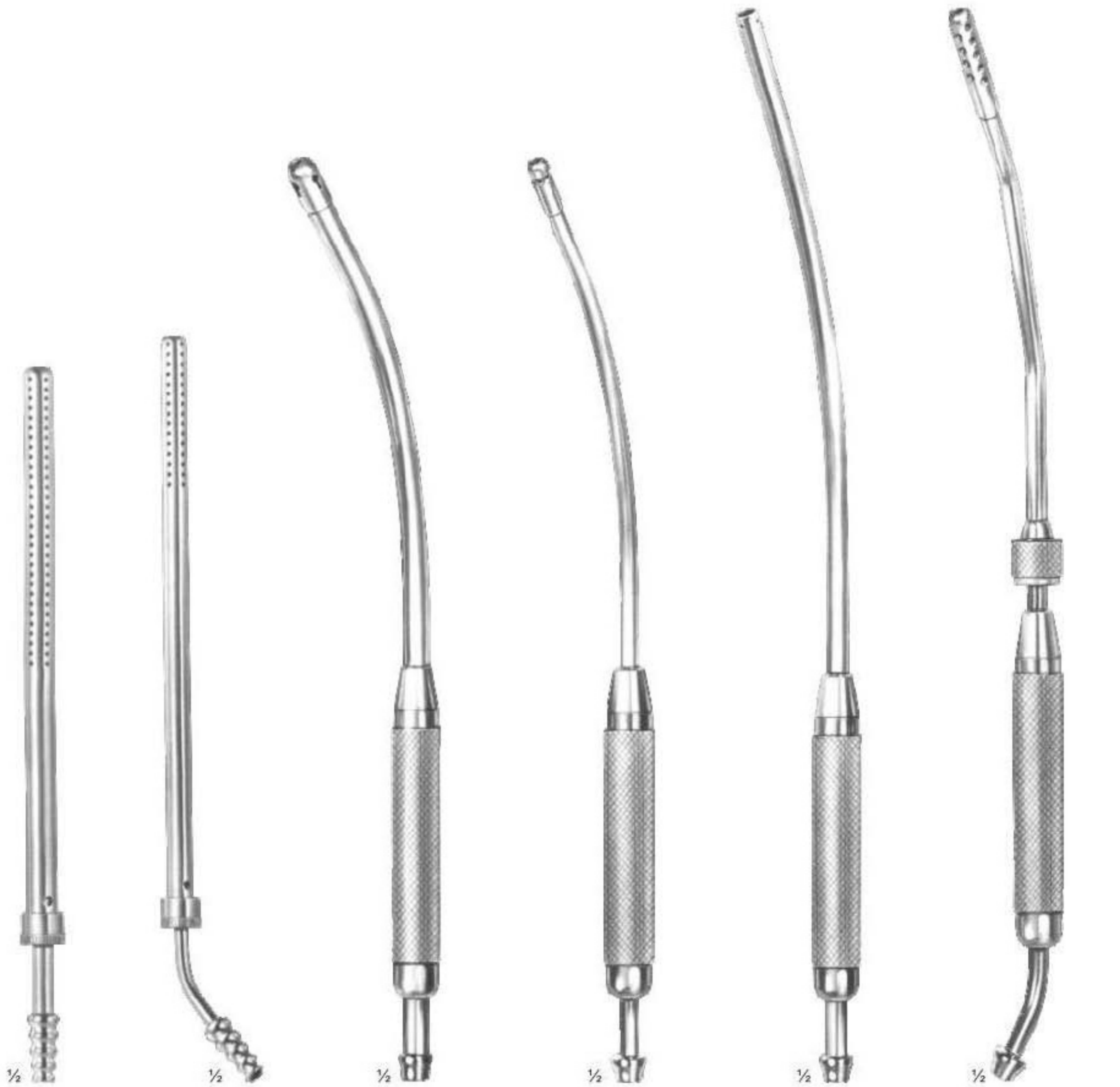

<p>POOLE 19-1055 24 cm ∅ 10 mm</p>	<p>POOLE 19-1056 25 cm ∅ 8 mm</p>	<p>COLLEY 19-1057 with perforated screw tip 31 cm ∅ 10 mm</p>	<p>COLLEY 19-1058 with perforated screw tip 31 cm ∅ 7 mm</p>	<p>COLLEY 19-1059 36 cm ∅ 8 mm</p>	<p>COLLEY 19-1060 with perforated screw tip 36 cm ∅ 8 mm</p>
--	---	---	--	--	--

Retractors For Cervical Vertebral Column



Vacuum Curettes For Aspiration Lipectomy, Suction Instruments

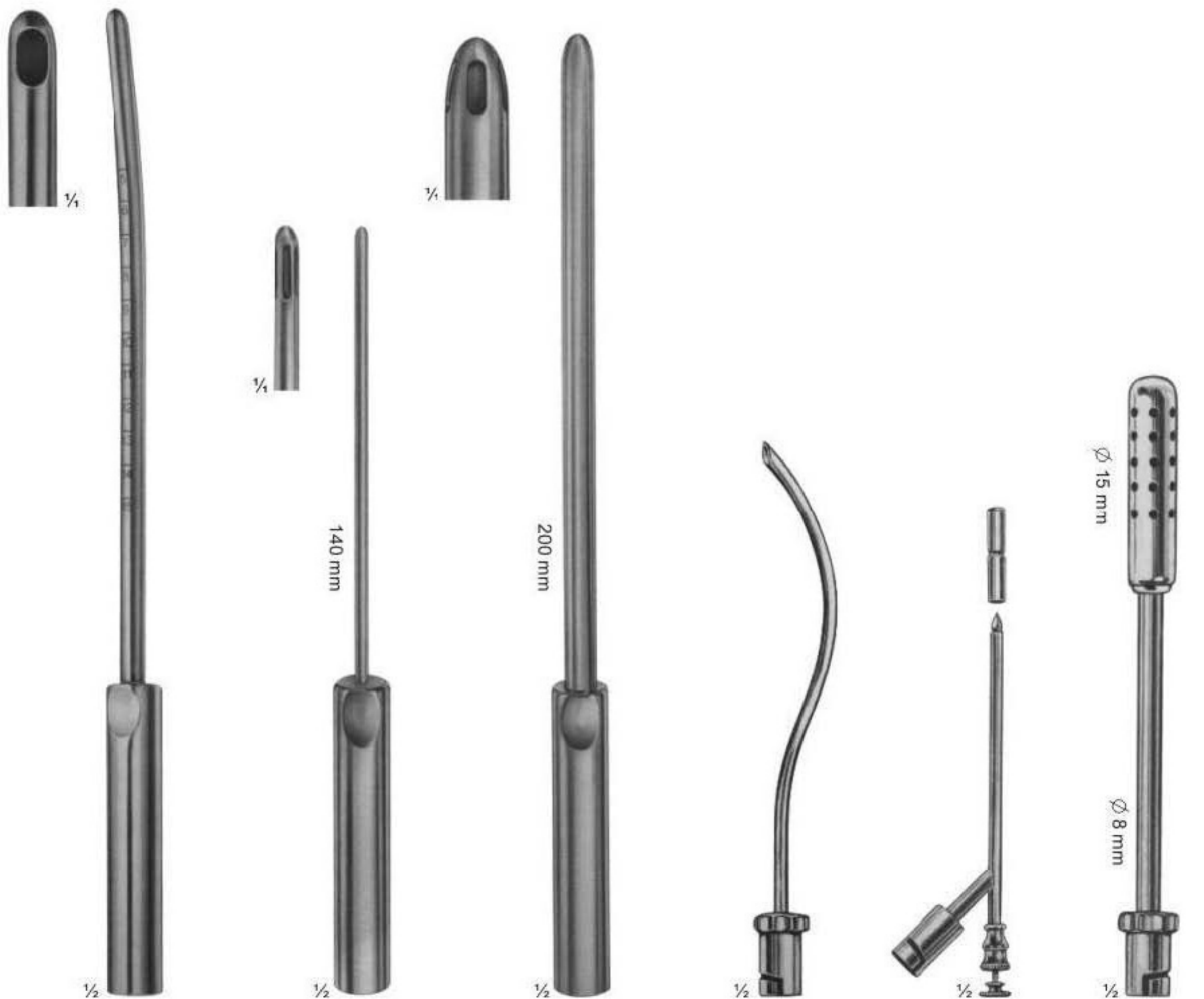

BIEMER
19-1069 - 19-1074
19-1069 Ø 4 mm
19-1070 Ø 6 mm
19-1071 Ø 8 mm
19-1072 Ø 10 mm
19-1073 Ø 12 mm
19-1074 Ø 14 mm
Curettes for aspiration lipectomy, graduated, slightly curved

BIEMER
19-1075 - 19-1076
19-1075 Ø 4 mm
19-1076 Ø 6 mm
Curettes for aspiration lipectomy, with three apertures, slightly curved malleable

BIEMER
19-1077 - 19-1079
19-1077 Ø 8 mm
19-1078 Ø 10 mm
19-1079 Ø 12 mm
Curettes for aspiration lipectomy, with three apertures, slightly curved malleable

19-1080
For aspirating fluid from the excretory ducts of large glands and for keeping the operating area clear
17 cm

19-1081
Trocar
For puncturing
15 cm

19-1082
For clearing large quantities of fluid
19 cm

Suction Instruments



YANKAUER 19-1083
with especially large central bore, 4,8 mm diam.
28.5 cm



YANKAUER 19-1084
with central bore, 2,0 mm diam.
28.5 cm



DE-BAKEY 19-1085
with central bore, 3,0 mm diam. with lateral slots
27.5 cm



DE-BAKEY 19-1086
with finger cut-off and stylet
27 cm



19-1087
with finger cut-off
19 cm



GORNEY 19-1088
Suction dissector
18 cm

Suction Instruments



19-1089 ∅ 1.5 mm
19-1090 ∅ 2 mm
19-1091 ∅ 2.5 mm
19-1092 ∅ 3 mm

PLESTER
19-1089 - 19-1092
with finger cut-off and
stylet, thumb piece
parallel to curved, with
LUER hub
19.5 cm



19-1093 ∅ 2 mm
19-1094 ∅ 2.5 mm
19-1095 ∅ 3 mm
19-1096 ∅ 4 mm
19-1097 ∅ 5 mm

FERGUSSON
19-1093 - 19-1097
with finger cut-off and
stylet, thumb piece
90° to curved, with
LUER hub
18 cm



FERGUSSON
19-1098 4 mm ∅
insulated, with finger cut-off
and stylet, thumb piece 90°
to curved, with LUER hub
18 cm



FRAZIER
19-1099 - 19-1100
19-1099 ∅ 3 mm
19-1100 ∅ 5 mm
insulated, with finger
cut-off and stylet, thumb
piece 90° to curved,
with LUER hub
18 cm



19-1101 19.5 cm ∅ 2 mm
19-1102 19.5 cm ∅ 2.3 mm
19-1103 19.5 cm ∅ 3 mm
19-1104 19.5 cm ∅ 3.3 mm
19-1105 19.5 cm ∅ 3.6 mm
19-1106 19.5 cm ∅ 4 mm
19-1107 19.5 cm ∅ 5 mm

FRAZIER
19-1101 - 19-1107
∅ 3.3 mm



19-1108 ∅ 2 mm
19-1109 ∅ 2.6 mm
19-1110 ∅ 3.3 mm
19-1111 ∅ 4 mm

POPPEL
19-1108 - 19-1111
working length
90 mm



19-1112
5,0 mm diam., Tip
6,5 mm wide, Nasal
suction tube, with
LUER hub
18 cm



19-1113 - 19-1114
19-1113 ∅ 4.5 mm
19-1114 ∅ 5.5 mm
Nasal suction
tubes
17.5 cm



19-1115 - 19-1116
19-1115 4 mm wide
19-1116 5 mm wide
Suction raspatories,
sharp, bayonet-shaped,
with stylet
20 cm



LOPEZ-REINKE
19-1117
Tonsil dissector with
suction device
23.5 cm

Suction Instruments

WULLSTEIN
19-1118
Suction tube, convical, silver, oliver
with LUER hub
16 cm

Ø 1,75 mm

Ø 3 mm
1/2
Ø 8 mm

WULLSTEIN
19-1119 1.5 mm
19-1120 2 mm
Suction tube, cylindrical, silver, with
stylel with LUER hub
16 cm

1/2
Ø 8 mm

Usable length

YASARGIL usable length diam.			YASARGIL usable length diam.		
19-1121	13 cm	1.5 mm	19-1129	13 cm	2.5 mm
19-1122	15 cm	1.5 mm	19-1130	15 cm	2.5 mm
19-1123	18 cm	1.5 mm	19-1131	18 cm	2.5 mm
19-1124	22 cm	1.5 mm	19-1132	22 cm	2.5 mm
19-1125	13 cm	2 mm	19-1133	13 cm	3.5 mm
19-1126	15 cm	2 mm	19-1134	15 cm	3.5 mm
19-1127	18 cm	2 mm	19-1135	18 cm	3.5 mm
19-1128	22 cm	2 mm	19-1136	22 cm	3.5 mm

Ø 6.5-9 mm
with LUER hub

LANDOLT
19-1137 - 19-1139
15 cm
diam Ø 3 mm

19-1137 8 mm / curved
19-1138 11mm / curved
19-1139 15mm / curved

Ø 3.5 mm

Ø 2.0 mm

19-1140 5 cm
19-1141 35 cm
with rubber tip,
with LUER hub

Ø 9 mm

19-1142 2 mm diam
19-1143 2.5 mm diam
19-1144 3 mm diam
with finger cut-off,
thumb piece 90° to
curved, with LUER hub
25 cm

Ø 6-9 mm

Combined Suction And Irrigation Cannula

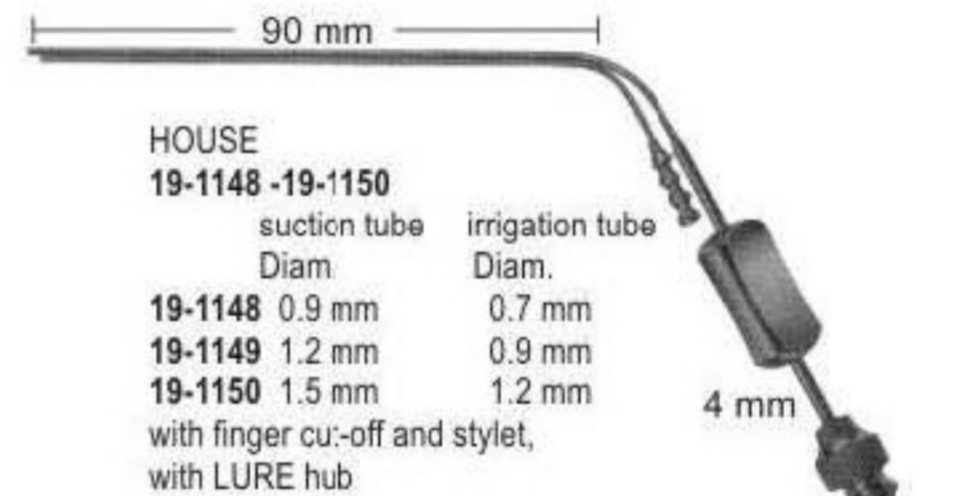

A	
Abraham Tonsil Knives	284
Adson (Baby) Delicate Haemostatic Forceps	229
Adson Cervical Vertebral Column	557
Adson Delicate Forceps	62
Adson Delicate Haemostatic Forceps	229
Adson Delicate Tissue Forceps	58
Adson Dura Hooks	333
Adson Needle Holders	80
Adson Raspatories	472
Adson Retractors For Cervical Vertebral Column	363
Adson Self-Retaining Laminectomy Retractors	148,149
Adson Tungsten Carbide Inserts Forceps	70
Adson-Baby Self-Retaining Retractors	145
Adson-Brown Delicate Tissue Forceps	58
Adson-Brown Tungsten Carbide Inserts Forceps	70
Alan-Parks Rectal Spreaders	204
Alexander Bone Rongeurs	421
Alexander Osteotomes Chisels	450
Alexander Rib Raspatories	465
Allen Intestinal Clamps	187
Allis Tissue Grasping Forceps	186
Allis-Adair Tissue Grasping Forceps	186
Allison Rib Spreaders	507
Alm Self-Retaining	143
Anderson-adson Retractors For Cervical Vertebral Column	360
Anderson-Adson Self-Retaining Laminectomy Retractors	148
Angle Wire Cutters	496
Angled Scissors	55
Arruga Delicate Tissue Forceps	68
Asch Biopsy Curettes	326
Asch Septum Forceps	289
Aufricht Bone File and Rasps	476
Aufricht Nasal Rasps	287
Auvarad Vaginal and Wound Retractor	303
Ayre Myoma Instruments	315
B	
Babcock Tissue Grasping Forceps	185
Baby nail Scissors	27
Baby-Adson Delicate Forceps	220
Baby-Collin Abdominal Retractors	153
Baby-Crile Delicate Haemostatic Forceps	223
Baby-Kocher Intestinal Clamps	187
Baby-Mikulicz Peritoneum Forceps	252
Baby-Mixter Delicate Forceps	220
Baby-Mosquito Delicate Haemostatic Forceps	219
Baby-Overholt Delicate Forceps	200
Baby-Roux Retractors	141
Baby-Senn-Miller Retractors	140
Baby-Tischler Cervical Biopsy	97
Backhaus Towel Clamps	245
Backhaus-kocher Towel Clamps	245
Badgley Retractors For Cervical Vertebral Column	356
Bailey Rib Spreaders	506
Bailey-Gibbon	506
Bainbridge Intestinal Clamps	187
Bakes Gall Stone Scoops	172
Balfour Abdominal Retractors	156
Balfour-Baby Abdominal Retractors	155
Ballenger Clip Applying Forceps	387
Ballenger -Hajek Periosteal Elevators	286
Bane-Hartmann Bone Rongeurs	420
Barnhill Clip Applying Forceps	387
Baron-Schuknecht Cervical Vertebral Column	555
Barr Pylorus Clamps	203
Barraquer Micro Needle Holders	83
Barraquer Needle Holders	96
Barry Sternal Needle Holders	93
Barth Bone Curettes	462
Baumgartner Needle Holders	81
Beacham Hook	310
Beckmann Clip Applying Forceps	387
Beckmann Nasal Specula	279
Beckmann-Adson Retractors For Cervical Vertebral Column	363
Beckmann-Adson Self-Retaining Laminectomy Retractors	149
Beckmann-Eaton Retractors For Cervical Vertebral Column	363
Beckmann-Eaton Self-Retaining Laminectomy Retractors	149
Beebee Plate Scissors	28
Beer Splinter Forceps	67
Belucci Micro Ear Forceps	269

Bending Pliers	418	Brand Tendon Holding Forceps	406
Bengolea Delicate Haemostatic Forceps	225	Braun Obstetrics-Placenta	258
Bennett Special Bone Lever	483	Braun Obstetrics-Placenta	258
Bensaude Anusscopes-Sphincteroscopes	205	Braun Uterine Depressor	308
Benson Stomach Clamps	198	Braun Uterine Tenaculum Forceps	310
Berger Biopsy Forceps	316	Braun Vaginal Specula	299
Bergmann Mallets	428	Breisky Obstetrics-Pelvimeters	255
Bergmann Plaster Scissors	263	Breisky Vaginal Specula	302
Bergmann Sponge Forceps	176	Briesky Set Lower Blades	295
Bergmann Wound-Trachea Retractors	106	Brinkerhoff Pylorus Clamps	203
Beyer Bone Rongeurs	421	Brock Micro Needle Holders	83
Biemer Suction Instruments	560	Brodie probes	98
Billeau Ear Loops-Hooks	282	Brom Nerve Hooks	331
Biopsy Curettes	326	Brophy Delicate Dissecting Forceps	61
Bircher Meniscus	416	Brophy Jaws Delicate Dissecting Forceps	61
Bircher-Ganske Cartilage Forceps	416	Brophy Tissue Forceps	63
Bishop-Harmon Delicate Tissue Forceps	68	Brown Tissue Forceps	63
Blake Aortic Dilators	383	Bruenings Tonsil Knives	284
Blake Gall Stone Forceps	163	Bruenings Tonsil Snares	381
Blake Uterine Scoops	321	Brunings Broncho-Esophagoscopy Forceps	378
Blumenthal Bone Rongeurs	420	Brunings Exchangeable Tips	399
Bodenyhammer Rectal Speculums	201	Brunings Tonsil Knife	398
Boer Basiotribe Forceps	258	Brunner Guiding Probes	86
Bohler Bone Cutting Forceps	442	Brunner Intestinal Clamps	191
Bohler Bone Rongeurs	422	Brunner Ligation Needles	77
Bone File and Rasps	477	Brunner Retractors For Deep Surgery	126
Bone Lever	479	Brunner Rib Shears	499
Bonn Eye Scissors	27	Bruns Bone Curettes	456
Bonney Tissue Forceps	66	Bruns Plaster Scissors	264,265
Bonney Tungsten Carbide Inserts Forceps	69	Buchs Retractors	117
Bose Tound and Tracheal Hooks	403	Buck Cotton Applicators	101
Bose Wound Spreaders	143	Buck Ear Curettes	274
Boucheron Ear Specula	275	Buck Paracentesis Needles	283
Bowman probes	100	Buck-Gramcko Bone Lever	482
Boynton Needle Holders	79	Buie Biopsy Forceps	207
Boys-Allis Tissue Grasping Forceps	186	Buie Intestinal Clamps	195
Bozemann Needle Holders	93	Bumm Haemorrhoidal Forceps	259
Bozemann Operating Scissors	22	Bumm Uterine Curettes	324
Bozemann Tendon Seizing Forceps	183	Bunnell Tendon Strippers	485,486
Bozemann Uterine Dressing Forceps	182	Bunt Towel Clamps	244
Bozemann-Douglas Tendon Seizing Forceps	183	Burford Rib Retractors	503

Burke Cervical Biopsy	97	Colley Cervical Vertebral Column	558
Bushe Bone Curettes	457	Collin Abdominal Retractors	153
Byrd Cervical Vertebral Column	557	Collin Amputating Knives	08
C			
Calne Aorta-Anastomosis Clamps	535	Collin Clip Applying Forceps	102,87
Caplan Septum Forceps	290	Collin Dressing Forceps	218
Carfoord-Sellors Tonsil Forceps	236	Collin Intestinal Grasping Forceps	184
Carpenter Tonsil Knife	398	Collin Mallets	431
Carrel Delicate Haemostatic Forceps	219	Collin Obstetrics-Pelvimeters	255
Carroll Tendon Tunneling Forceps	406	Collin Retractors	142
Caspar Dura Hooks	334	Collin Rib Shears	498
Caspar Nerve Root Retractors	341	Collin Sponge and Dressing Forceps	181
Caspar Osteotomes, Gouges	437	Collin Tissue Grasping Forceps	218
Caspar Retractors	117	Collin Umbilical cord Clamps	260
Caspar Retractors For Cervical Vertebral Column	343-352,366	Collin Uterine Curettes	324
Caspar Rongeurs	369,370	Collin Uterine Elevating Forceps	309
Casper Guiding Probes	86	Collin Vaginal Specula	294
Casper Raspatories	471	Collin-Hartmann Retractors	140
Castanesa Multi-Purpose Clamps	514	Colver Clip Applying Forceps	382
Castroviejo Delicate Tissue Forceps	68	Cone Cranial Rongeurs	329
Castroviejo Needle Holders	96	Cone Retractors For Cervical Vertebral Column	359
Castroviejo Razor Blades	01	Converse Fine Wound Retractors	103
Catlin Amputating Knives	08	Converse Needle Holders	81
Chaput Haemostatic Forceps	217	Cooley Aneurysm Clamps	381
Cheron Sponge and Dressing Forceps	181	Cooley Aorta-Anastomosis Clamps	516,541,547,550
Chevalier-Jackson Broncho-Oesophagoscopy Forcpes	291	Cooley Aortic Dilators	382,388
Chisel Osteotomes	447	Cooley Atrium Retractors	132
Chisels	451	Cooley Catheter Clamps	546
Chnad.Modell Meniscus Knives	493	Cooley Multi Purpose Vascular Clamps	551
Cinelli Dissecting Scissors	24	Cooley Multi-Purpose Clamps	515,516
Circular cutting Knife	276	Cooley Rib Retractors	501
Citelli Bone Rongeur	278	Cooley Vena-Cava Clamps	380
Citelli Punches	374	Cooley-Back Aorta-Anastomosis Clamps	551
Citelli-Beyer Punches	374	Cooper Ligature Needles	72
Claus Van Eicken Ligature Needles	72	Cordes Exchangeable Tips	400
Cleft Palate Instruments	383	Cottle Delicate Scissors	25
Cloward Lamina Spreaders	365	Cottle Fine Wound Retractors	103
Cloward Retractors For Cervical Spine	152	Cottle Forceps	59
Cloward-Type Retractors For Cervical Vertebral Column	355,358,359	Cottle Gouges	450
Cobb Osteotomes	448	Cottle Mallets	430
Cogswell Cervical Vertebral Column	557	Cottle Nasal Rasps	286
		Cottle Nasal Scissors	57

De-Bakey-Kelly Haemostatic Forceps	512	Doyen Retractors	135
De-Bakey-Mc Quigg-Mixter Anastomosis Clamps	518	Doyen Rib Raspatories	466
De-Bakey-Mixter Anastomosis Clamps	518	Doyen Towel Clamps	245
De-Bakey-pean Haemostatic Forceps	512	Doyen Vaginal Specula	300,302
De-Bakey-Rumel Anastomosis Clamps	518	Doyen-Child Abdominal Retractors	136
Delicate Scissors	25	Drill Guide Retractors For Cervical Vertebral Column	353,354
Demartel-Wolfson Intestinal Anastomosis Clamps	200	Drilling Chucks	484
Demel Micro Needle Holders	76	Dunhill Delicate Haemostatic Forceps	221
Denhart Mouth Gags	393	Duplay Uterine Tenaculum Forceps	310
Denis-Browne Lun Dissecting Forceps	66	Dura Hooks	335
Derf Needle Holders	81	Durogrip Wire Holding Forceps	497
Derra Multi-Purpose Clamps	516	Duval Intestinal Grasping Forceps	184
Derra-Cooley Aorta-Anastomosis Clamps	547	Duval Lun Dissecting Forceps	66
Deschamps Ligature Needles	73,74,75	Duval-Collin Intestinal Grasping Forceps	184
Desjardins Dissecting Forceps	240	E	
Desjardins Gall Duct Probes	173	Echlin Bone Rongeurs	424
Desjardins Gall Stone Forceps	164,165,172	Eiselsberg Ligature Scissors	29
Desmarres Retractors	108	Eiselsberg Needle Holders	78
Dick Hysterectomy Forceps	250	Eiselsberg-Mathieu Needle Holders	79
Dick Sigmoid Anastomosis Forceps	210	Elsasser Nephrostomy Forceps	162
Dick Vena-Cava Clamps	529	Elsching Delicate Tissue Forceps	68
Dieffenbach Tenotomes	07	Emmet Retractors	104
Dieffenbach Vessel Clips	74,331	Emmet Sponge and Dressing Forceps	181
Dieter Micro Ear Forceps	270	Emmett Fistula Hooks	315
Diethrich Tungsten Carbide Inserts	89	Engel Plaster Instruments	262
Diethrich Vena-Cava Clamps	531	Engl.Mob Towel Clamps	245
Diethrich Vessel Scissors	32	Eppendorf Biopsy Forceps	316
Dingmann Bone Holding Forceps	408	Esmarch Plaster Instruments	262
Dingmann Mouth Gags	396	Esmarch Plaster Scissors	263
Dissecting Knives	03	Eves Tonsil Snares	381
Distraction Pin A/B Retractors For Cervical Vertebral Column	353,354	F	
Dittel Gall Duct Dilators	172	Farabeuf Bone Holding Forceps	413
Dockhorn Retractors	117	Farabeuf Raspatories	464
Douglas Splinter Forceps	67	Farabeuf Retractors	140
Doyen Abdominal Retractors	135,136	Farabeuf-Lambotte Bone Holding Forceps	413
Doyen Delicate Scissors	19	Farrell Cotton Applicators	100,101
Doyen Haemorrhoidal Forceps	259	Faure Biopsy Forceps	318
Doyen Intestinal Clamps	188,189,190	Faure Peritoneum Forceps	252
Doyen Mallets	432	Favaloro Vessel Scissors	31
Doyen Myoma Instruments	315		
Doyen probes	98		

Fehland Intestinal Clamps	191	Frazier Suction Instruments	562
Fehland-Debaquey Intestinal Clamps	196	Freer Chisels	449
Feilchenfeld Splinter Forceps	67	Freer Fine Wound Retractors	103
Fergusson Bone Holding Forceps	409	Freer Raspatories	469,470
Fergusson Intestinal Clamps	195	Freer Septum Elevators	285
Fergusson Suction Instruments	562	Freer Tonsil Knives	284
Fergusson-Ackland Mouth Gags	393	Freer-Yasargil Raspatories	469
Fiber Optic Rectal Spreaders	204	Fritsch Abdominal Retractors	135
Fine Operating Scissors	27	Fuller Micro Ear Forceps	270
Finger Nail Instruments	494		
Finocchietto Needle Holders	92	G	
Finochietto Dissecting Forceps	240	Gallaher Bone File and Rasps	476
Finochietto Multi-Purpose Clamps	213	Gauss Ovum Forceps	260
Finochietto Rib Retractors	503,505	Gellhorn Biopsy Forceps	319
Finochietto, Infant Rib Retractors	502	Gelpi Retractors For Cervical Vertebral Column	364
Finochietto.Baby Rib Retractors	502,505	Gelpi Special Retractors	150
Finochietto.Infant Rib Retractors	502	Gemini Haemostatic Forceps	233
Fino-Metzenbaum Dissecting Scissors	16	Genito-Urinary Instruments	174
Finsen Dilators	403	Gerald Delicate Dissecting Forceps	61
Finsen Wound Spreaders	143	Gerald Forceps	64
Finsterer Combined Suction	564	Gerald Tissue Forceps	63
Fisch Micro Ear Raspatories	261	Gerald Tungsten Carbide Inserts Forceps	69
Fischer Tendon Strippers	486	Gerzog Paracentesis Needles	283
Fischer Tonsil Knives	284	Giertz-Stille Rib Shears	499
Fisher Tonsil Knife	398	Gigli Wire Saws	327
Flat-Nosed Pliers	511,497	Gill Delicate Tissue Forceps	68
Foerster-Ballenger Dressing Forceps	179	Gill-Hess Delicate Tissue Forceps	68
Foerster-Ballenger Sponge Forceps	175	Gillies Fine Wound Retractors	103
Fomon Bone File and Rasps	475	Gillies Needle Holders	78,94
Fomon Delicate Scissors	57	Gillies Tissue Forceps	63
Fomon Dissecting Scissors	24	Gillies Tungsten Carbide Inserts Forceps	69
Fomon Rasps With and Tungsten Carbide	288	Gill-Vernet Saddle Hooks	109
Fomon Retractors	107	Glover Anastomosis Clamps	521
Fomon Vessel Scissors	30	Glover Bulldog Clamps	215,510
Ford-Dixon Hemorrhoidal Ligator	206	Gloves Multi Purpose Vascular Clamps	528
Forster Sponge Forceps	175	Gluck Rib Shears	498,499
Fraenkel Exchangeable Tips	399	Goldman-Fox Ligature Scissors	54
Francke Blood Lancets	292,401	Goldman-Fox Vessel Scissors	30
Frazier Cervical Vertebral Column	557	Good Vessel Scissors	30
Frazier Dura Hooks	333	Goodell Uterine Dilators	305
Frazier Fine Wound Retractors	103	Gorney Face-lift Scissors	51

Gorney Suction Instruments	561	Hartmann Broncho-Esophagoscopy Forceps	378
Gosset Abdominal Retractors	155	Hartmann Ear Forceps	270
Gosset-Baby Abdominal Retractors	155	Hartmann Ear Specula	275
Gouges	451	Hartmann Intestinal Clamps	190
Gourdet Uterine Curettes	323	Hartmann Nasal Cutting Forceps	272
Graefe Fine Wound Retractors	103	Hartmann Nasal Dressing Forceps	280
Graefe Nerve Hooks	331	Hartmann Tongue Depressors	402
Graefe Scalpels	07	Hartmann-Noyes Ear Forceps	270
Graefe Tissue Forceps	63	Hartmann-Weingartner Ear Forceps	270
Graham Dura Hooks	333	Hartmann-Wullstein Ear Forceps	270
Graves Vaginal Specula	295	Harvey Plate Scissors	28
Gray Haemostatic Forceps	242	Harvey Wire Cutting Scissors	496
Green-Armytage Ovum Forceps	260	Hayes-Debaquey Intestinal Clamps	196
Gregory Profunda Clamps	545	Heaney Hysterectomy Forceps	250
Groningen Nerve Hooks	332	Heaney Needle Holders	82
Gross Sharp Spoons	273	Heath Clip Applying Forceps	88,102
Gross-Maier Sponge and Dressing Forceps	175	Heath Mallets	428
Gruenwald Forceps	59	Hegar Dilator	306
Guthrie Fine Wound Retractors	103	Hegar Needle Holders	82,93
Guyon Genito-Urinary Instruments	174	Hegar Uterine Dilators	306
Guyon Haemostatic Forceps	241	Hegar-Baumgartner Needle Holders	89
H		Hegar-Olsen Needle Holders	78
Haase Cartilage Seizing	407	Hegenbarth Clip Applying Forceps	87,102
Haase Tampers-Osteotomes	449	Heifetz Brain Spatulas	405
Haberer Abdominal Intestinal Spatulas	159	Heiming Gall Stone Forceps	161
Haight Rib Retractors	502	Heiss Haemostatic Forceps	229
Hajek Gall Duct Probes	173	Heister Mouth Gags	394
Hajek Mallets	427	Hemilaminectomy Retractors For Cervical Vertebral Column	361
Hajek-Kofler Punches	375	Hemingway Bone Curettes	463
Halle Bone Curettes	457	Hening Plaster Spreader	268
Halle Grasping Forceps	384	Henke Tonsil Dissectors	377
Halle Raspatories	470	Henley Wound Spreaders Self-Retaining	147
Halle Septum Elevators	285	Hepp Scheidel Needle Holders	96
Halsey Needle Holders	81,90	Herbert Mallets	429
Halsted Delicate Haemostatic Forceps	224	Herff Puncturing Forceps	312
Halsted-Mosquito Delicate Haemostatic Forceps	219,224	Herget Biopsy Forceps For Forceps	208
Hank Uterine Dilators	307	Herrick Tonsil Forceps	243
Harken Auricle Clamps	537	Hertzler Abdominal Retractors	155
Harken Multi-Purpose Clamps	519	Herz Tendon Seizing Forceps	246
Harrington Retractor	312	Hess Delicate Tissue Forceps	68
		Hess Nerve Root Retractors	341

Hey Groves Bone Holding Forceps	412	Jackson Clip Applying Forceps	382
Heymann-knight Vessel Scissors	30	Jackson Tendon Seizing Forceps	246
Heywood-Smith Polypus ovum Forceps	314	Jackson Tracheal Tubes With Inner Tubes	404
Hibbs Osteotomes	449,455	Jackson Vaginal Specula	298
Hirschmann Anusscopes-Sphincteroscopes	205	Jacobs Uterine Tenaculum Forceps	313
Hohmann-Aldinger Bone Lever	481	Jacobson Bone Curettes	462
Hoke Osteotomes	455	Jacobson Dura Hooks	336
Holsher Nerve Root Retractors	342	Jagar Fine Wound Retractors	103
Holzbach Abdominal Retractors	154	Jager Tendon Seizing Forceps	246
Hopfner Multi-Purpose Clamps	214	Jameson Dissecting Scissors	26
Hopfner Vaginal Clamps	253	Jameson Needle Holders	82
Hopkins Plaster Instruments	262	Jansen Bone Curettes	463,462
Hopt Vena-Cava Clamps	517	Jansen Bone Rongeurs	420,421
Hosel Retractors	118,121	Jansen Forceps	59
House Irrigation Cannula	564	Jansen Rib Raspatories	465
Howarth Raspatories	469	Jansen Self-Retaining	143
Huber Broncho-Esophagoscopy Forceps	378	Jansen Sharp Spoons	273
Humby Dermatomes	09	Javid Catheter Clamps	546
Hunt Tumors Forceps	65	Jennings Mouth Gags	397
Hunter Splinter Forceps	67	Johns-Hopkins Vessel Clips	215,510
Hurd Cleft Palate Needles	398	Joll (Friedman) Special Retractors	150
Hurd Ligature Needles	73	Joll Special Retractors	304
Hurd Tonsil Dissectors	377	Jones Towel Clamps	245
Husfeldt Peripheral Vascular Clamps	545	Jonesco Ligature Needles	73
Hysterectomy Scissors	53	Joseph Bone File and Rasps	476
I			
Incision Surgical Scissors	14	Joseph Dissecting Scissors	24
Inge Lamina Spreaders	365	Joseph Fine Wound Retractors	203
Inge Retractors For Cervical Vertebral Column	355	Joseph Operating Scissors	46
Intima Spatulas	385	Joseph Raspatories	468
Iowa Puncturing Forceps	313	Joseph Septum Elevators	285
Iris Delicate Scissors	25	Judd-Allis Tissue Grasping Forceps	186
Iris Ligature Scissors	36	Judd-Masson Bladder Retractors	170,171
Iris Scissors	54	Jurasz Clip Applying Forceps	380
Israel Retractors	111	K	
Ives-fansler Anusscopes-Sphincteroscopes	205	Kader Intestinal Spatulas	138
J			
Jaboma Cleft Palate Instruments	322	Kaevorkian Vacuum Curettes	325
Jaboma-Tc Tissue Forceps	71	Kahre-Williger Periosteal Elevators	474
Jackson Burrows Special Retractors	150	Kalt Tungsten Carbide Inserts	89
		Kane Umbilical cord Clamps	260
		Katzenstein Swab Holders	207

Kazanjian Bone Cutting Forceps	440	Kocher Intestinal Clamps	188,191
Kelly Anusscopes-Sphincteroscopes	205	Kocher Ligature Needles	72
Kelly Delicate Haemostatic Forceps	222	Kocher Retractors	110,111,112,116,117,127
Kelly Delicate Scissors	19,56	Kocher-Delicate Haemostatic Forceps	227
kelly Ligature Forceps	239	Kocher-Langenback Retractors	115
kelly Polypus ovum Forceps	314	Koenig Guiding Probes	85
Kelly Retractors	120	Kogan Endocervical Specula	305
Kelly Retractors For Deep Surgery	134	Kolle Microscopic Needle Holder	292,401
Kelly-Rankin Delicate Haemostatic Forceps	222	Kolner Applying Forceps	330
Kern-Lane Bone Holding Forceps	412	Konig Elevators	467
Kerpel Bone Curettes	463	Konig Raspatories	468
Kerrison Bone Rongeur	278	Konig Retractors	108
Kerrison Punches	375	Korte Retractors	111
Kerrison-Jacoby Suction Instruments	376	Krause Exchangeable Tips	400
Kersting Sigmoid Anastomosis Forceps	211	Krayenbuehi Dura Hooks	334
Kevorkian Biopsy Forceps	316	Kristeller Lower Blades	296,297
kevorkian-Pacific Biopsy Forceps	317	Kristeller Set Upper Blades	296
Kevorkian-Pacific Cervical Biopsy	97	Kristeller Upper Blades	296,297
Kielland Obstetrics-Forceps	256	Kristeller Vaginal Specula	296,298
Kielland-Luikart Obstetrics-Forceps	256	Kronecker Suture Instruments	74
Killian Nasal Specula	279	Kronlein Haemostatic Forceps	216
Killian probes	100	Kummel Intestinal Spatulas	138
Killian Raspatories	469	Kustner Uterine Tenaculum Forceps	425
Killian Rectal Speculums	201		
killian Rib Shears	498	L	
Kilner Dissecting Scissors	26	Laborde Dilators	403
Kilner Fine Wound Retractors	203	Lahey Ligature Forceps	240
Kilner Needle Holders	80	Lahey Retractors	109
Kilner-Doughty Mouth Gags	395	Lahey Uterine Tenaculum Forceps	311
Kirschner Abdominal Retractors	158	Lambotte Bone Holding Forceps	415
Kirschner Guiding Probes	86	Lambotte Gouges	450
Kirschner Wire Extension	487,488	Lambotte Osteotomes	454
Kirschner-balfour Abdominal Retractors	158	Lambotte Raspatories	464
Klapp Retractors	104	Lambotte-Mini Gouges	452
Kleinert-Kutz Tendon Interlacing Forceps	405	Landolt Dissecting Scissors	18
Kleinschmidt Stomach Clamps	198	Landolt Irrigation Cannula	564
Knives	02	Landolt Suction Instruments	563
kocher Bladder Retractors	168	Landot Raspatories	471
Kocher Bone Retractors	110	Lane Bone Holding Forceps	414
Kocher Guiding Probes	85	Lane Bone Lever	478
Kocher Haemostatic Forceps	227	Lane Gastro-Intestinal Forceps	212

Lane Tissue Forceps	66	Lichtenberg Needle Holders	95
Lane Tissue Grasping Forceps	185	Ligature Adjuster Guiding Probes	86
Lane Towel Clamps	245	Ligature Scissors	35,36
Lane Trethowan Bone Lever	478	Lister Plaster Scissors	265
Lange Exchangeable Tips	399	Lister Sponge and Dressing Forceps	181
Lange Retractors	104	Liston Amputating Knives	08
Lange-Hohmann Bone Lever	478	Liston Bone Cutting Forceps	440,441
Langenback Autopsy Knives	08	Liston-Key-Horsley Bone Holding Forceps	443
Langenback Bone Holding Forceps	409	Liston-Stillé Bone Holding Forceps	443
Langenback Bone Lever	467	Littauer Ligature Scissors	29
Langenback Elevators	473	Littauer Splinter Forceps	67
Langenback Osteotomes	448	Little Retractors	109
Langenback Raspatories	464	Littler Delicate Scissors	25
Langenback Retractors	115	Lloyd-Davies Cartilage Scissors	34
Langenbaeck Needle Holders	95	Lloyd-Davis Sigmoid Anastomosis Forceps	210
Langenbeck Ear Curettes	273	Lockhart-Mummery probes	98
Langenbeck-Green Retractors	107	Locklin Tonsil Gum Scissors	57
Langenbeck-Mannerfelt Retractors With Triangular Handle	105	Locklin Vessel Scissors	30
Laryngeal Mirrors	292,401	Lockwood Tissue Grasping Forceps	185
Lathbury-Farrel Cotton Applicators	100,101	Lopez-Reinke Suction Instruments	562
Lawrence Ligature Forceps	238	Lorna Towel Clamps	244
Lebsche Conductor	327	Loute Drilling Chucks	484
Lebsche Rib Shears	498	Love Nerve Root Retractors	341
Lees Vena-Cava Clamps	553	Love-Gruenwald Rongeurs	369,371,373
Legueu Bladder Retractors	168,170	Lovelace Delicate Haemostatic Forceps	222
Lekell-Stillé Bone Rongeurs	423	Lovelace Lung Grasping Forceps	509
Leland-Jones Aneurysm Clamps	381	Lower Ligature Forceps	240
Leland-Jones Vena-Cava Clamps	524,526,380,381	Lowman Bone Clamps	417
Lempert Bone Curettes	457	Lowman-Gerster Bone Clamps	417
Lempert Bone Rongeurs	421	Lowman-Hoglund Bone Clamps	417
Lempert Septum Elevators	285	Lubet-Barbon Nasal Dressing Forceps	280
Lerche Lun Dissecting Forceps	66	Luc Nasal Cutting Forceps	281
Leriche Delicate Haemostatic Forceps	221	Lucae Ear Loops-Hooks	282
Lericher Intestinal Spatulas	138	Lucae Forceps	59
Lewin Bone Holding Forceps	407	Lucae Mallets	431
Lewis Bone File and Rasps	476	Lucae Paracentesis Needles	283
Lewkowiz Ovum Forceps	258	Lucae Tissue Forceps	63
Lexer Dissecting Scissors	17,47	Lucas Bone Curettes	463
Lexer Osteotomes,Gouges	438,439,446,447	Lucas Gouges	451
Lexer-Fino Dissecting Scissors	18	Luer Bone Rongeurs	420,422
Lexer-Mini Osteotomes,Gouges	438,439,446	Luer Cervical Vertebral Column	556

Luer Ovum Forceps	259	Maulbreite Jaw Width Biopsy Forceps	209
Luer Retractors	142	Maunder Mouth Gags	394
Luer Tracheal Tubes With Inner Tubes	404	Mayo Dissecting Scissors	10
Luer-Friedmann Bone Rongeurs	419	Mayo Gall Duct Probes	173
Luer-Korte Gall Stone Scoops	172	Mayo Operating Scissors	41
Luer-Stille Bone Rongeurs	425,426	Mayo Towel Clamps	244
Luniatschek Gauze Packers	377	Mayo-Adams Self-Retaining Retractors	145
Lurz Kidney Stone Forceps	167	Mayo-Blake Gall Stone Forceps	163
M		Mayo-Harrington Dissecting Scissors	12
Mac Bonald Raspatories	469	Mayo-Hegar Needle Holders	82,91,92
Maltz Bone File and Rasps	476	Mayo-Lexer Dissecting Scissors	47
Maltz Nasal Rasps	286	Mayo-Lexer-Aquila Scissors	39
Mannerfelt Gouges	449	Mayo-Noble Dissecting Scissors	14
Mannerfelt Osteotomes Chisels	451	Mayo-Robson Intestinal Clamps	450,451
Mannerfelt Retractors With Triangular Handle	105	Mayo-Stille Dissecting Scissors	15,42
Mannerfet Raspatories	472	Mayo-Thorek Dissecting Scissors	46
Markham-Meyerding Retractors For Cervical Vertebral Column	359	Mc Indoe Delicate Dissecting Forceps	60
Marquardt Bone Rongeurs	422	Mc Indoe Tissue Forceps	64
Martel-Pees Sponge Holding Forceps	218	Mc Indoe Tungsten Carbide Inserts Forceps	71
Martin Cartilage Forceps	416	Mc Kenty Raspatories	287
Martin Obstetrics-Pelvimeters	255	Mcgee Micro Ear Forceps	535
Martin Retractors For Deep Surgery	125	Mcgivney Hemorrhoidal Ligator	466
Martin Uterine Sounds	308	Mckenzie Applying Forceps	392
Martin Vaginal Specula	303	Mclvor Mouth Gags	560
Martin Wire and Cutting Scissors	56	Mcquigg-Mixter Haemostatic Forceps	91
Martin-Fuchsig Delicate Haemostatic Forceps	224	Mead Bone Rongeurs	240
Martini Bone Curettes	462	Mead Mallets	255
Martin-ideal Finger Nail Instruments	494	Mead Raspatories	289
Masing Periosteal Elevators	286	Meeker Dissecting Forceps	98
Masing Retractors	108	Meriem Tissue Forceps	73
Masson Needle Holders	82,92	Metzenbaum Dissecting Scissors	19,37,43,44,45
Masson-Luethy Needle Holders	82	Metzenbaum-Aquila Scissors	38
Mathieu Bladder Retractors	171	Metzenbaum-Aquila-Fino Scissors	39
Mathieu For Children Virgins	299	Metzenbaum-Fino Delicate Dissecting Scissors	48,49,50
Mathieu Needle Holders	79,95	Metzenbaum-Lahey Delicate Dissecting Scissors	49
Mathieu Rectal Specula	202	Metzenbaum-Nelsong Dissecting Scissors	19
Mathieu Retractors	142	Meyer Bone Holding Forceps	226
Mathieu-Kocher Mathieu	79	Meyerding Retractors	127
Mathieu-Kocher Needle Holders	95	Meyerding Retractors For Deep Surgery	145
Mathieu-Stille Needle Holders	79	Michel Clip Applying Forceps	185,212
		Michel Rhinoscopic Mirrors	554,579

Micro Adson Tungsten Carbide Inserts Forceps	70	Morse Rib Retractors	504
Micro Ear Forceps	269	Morse-Favaloro Rib Retractors	504
Micro Ear Needles	277	Mosquito Haemostatic Forceps	511
Micro Instruments For Laryngo	291,401	Moynihan Gall Duct Probes	173
Micro-Adson Delicate Forceps	62,220	Moynihan Intestinal Clamps	194
Micro-Adson Delicate Tissue Forceps	58	Moynihan Tonsil Forceps	242
Micro-Halsted Delicate Haemostatic Forceps	219	Mueller Wound Spreaders	143
Middeldorpf Retractors	117,122	Muhling Raspatories	471
Middleton-Jansen Septum Forceps	290	Muller Fine Wound Retractors	103
Mikro-Hegemann Vessel Scissors	32	Muller Ligature Forceps	60
Mikulicz Intestinal Spatulas	138	Muller Micro Needle Holders	83
Mikulicz Peritoneum Forceps	252	Muller Vessel Clips	215,510
Mikulicz Retractors For Deep Surgery	133,134	Murphy-Lane Special Bone Lever	483
Milan Uterine Curettes	323	Museux Clip Applying Forceps	382
Miller Alveotomy Files	473	Museux Uterine Tenaculum Forceps	313
Miller Bone File and Rasps	475		
Milligan Dura Dissectors	339	N	
Millin Bladder Retractors	170	Nagele Obstetrics-Forceps	256
Millin Capsule Forceps	165,166	Nail Scissors	27
Millin Kidney Stone Forceps	167	Narrow Delicate Tissue Forceps	58
Millin Needle Holders	79	Narrow Dissecting Forceps	62
Mini-Gemini Haemostatic Forceps	233	Nasal Cutting Forceps Circular	271
Mini-Townsend Cervical Biopsy	97	Neff Meniscus Knives	491,492
Mini-Weitlaner Retractors For Cervical Vertebral Column	361	Negus Ligature Forceps	238
Mirror Handle	292,401	Negus Tonsil Forceps	242
Miskimon Retractors For Cervical Vertebral Column	364	Nelaton probes	98
Mixer Haemostatic Forceps	231,232	Nelson Lun Dissecting Forceps	66
Mixer Multi-Purpose Clamps	214	Neubuser Myoma Instruments	315
Mixer-Baby Haemostatic Forceps	230	Neukam Mouth Gags	395
Mixer-O'Shaughnessy Haemostatic Forceps	231	Nissen Ligature Forceps	240
Mod.Munchen Biopsy Curettes	326	Norfolk & Norwich Retractors For Cervical Vertebral Column	365
Mod.Usa Plaster Spreader	268	Norfolk and Norwich Self-Retaining Laminectomy Retractors	148
Mod.Wien Nasal Specula	279	Norwood Biopsy Forceps	207
Modell Tubingen Retractors For Deep Surgery	125	Noto Polypus ovum Forceps	314
Modell Usa Bone Curettes	458,460	Novak-Schoeckaert Biopsy Curettes	326
Mollison Self-Retaining Retractors	145	Noyes Nasal Dressing Forceps	280
Molt Mouth Gags	393	Nuboer Cervical Vertebral Column	557
Molt Raspatories	469	Nussbaum Intestinal Clamps	194
Morris Vena-Cava Clamps	528,526		
Morris Retractors	120	O	
Morris Sigmoid Anastomosis Forceps	211	Obwegerser Tissue Forceps	71

Obwegeser Chin and Channel Retractors	386	Patella Forceps	408
Obwegeser Delicate Haemostatic Forceps	222	Paulsen Raspatories	470
Obwegeser Mouth Gags	394	Payr Guiding Probes	85
Obwegeser Periosteal Elevators	388,389,391	Payr Intestinal and Pylorus Clamps	199
Obwegeser Soft Tissue Retractors	385	Pean (Ochsner) Haemostatic Forceps	228
Ochsner Gall Duct Probes	173	Pean (Rochester) Haemostatic Forceps	228
Ochsner Vena-Cava Clamps	527	Pean Haemostatic Forceps	216,226,512
Oehler Tungsten Carbide Inserts Forceps	69	Pean-Delicate Haemostatic Forceps	226
Oesophagoscopy Forceps	291	Peet Cilia Forceps	67
Oldberg Rongeurs	372	Pelkmann Uterine Dressing Forceps	182
Olivecrona Brain Spatulas	405	Penfield Dura Dissectors	340
Olivecrona Vessel Scissors	33	Pennington Organ Forceps	218
Olivecrona-Toennis Applying Forceps	330	Percy Amputation Retractors	495
Olivercrona Bone Rongeurs	422	Perkins Self-Retaining Retractors	146
Olivercrona Dura Dissectors	337,338	Pestalozza Placenta Scoops	261
Olivercrona Wire Saws	327	Phaneuf Vaginal Clamps	250
Olsen-Hegar Needle Holders	94	Piper Obstetrics-Forceps	256
Ombredanne Mallets	428	Pittsburgh Liver Forceps	535
Operating Scissors	40	Plate Scissors	28
Organ Grasping Forceps	217	Plester Hooks	261
Oringer Cheek Retractors	397	Plester Micro Ear Raspatories	276
Osteotomes	451	Plester Self-Retaining Retractors	146
Osteotomes, Gouges	436	Plester Suction Instruments	562
O'sullivan-O'connor Special Retractors	304	Poberts Haemostatic Forceps	237
Overholt Haemostatic Forceps	235	Politzer Ear Specula	275
Overholt-Delicate Haemostatic Forceps	235	Politzer Paracentesis Needles	283
Overholt-Geissendoerfer Dissecting and Ligature Forceps	234	Poole Cervical Vertebral Column	558
Overholt-Martin Haemostatic Forceps	230	Poppen Suction Instruments	562
Overholt-Mini Delicate Forceps	220	Potts Coarctation Clamps	549
Overholt-Mini Haemostatic Forceps	233	Potts Multi Purpose Vascular Clamps	539,540
Overholt-Mixer Haemostatic Forceps	230	Potts-Nevins	71
P			
Paracentesis Needles	283	Potts-Smith Tissue Forceps	62
Parker Hooklets	139	Potts-Smith Tungsten Carbide Inserts Forceps	69
Parker-Kerr Sigmoid Anastomosis Forceps	210	Potts-Smith Vessel Scissors	31,33
Parker-Mott Retractors	141	Pozzi Uterine Tenaculum Forceps	310
Parry-Cooley Aorta-Anastomosis Clamps	542	Pratt Biopsy Forceps	207
Partsch Gouges	451	Pratt Rectal Specula	202
Partsch Mallets	429	Pratt Sponge Holding Forceps	218
Partsch Raspatories	468	Price Thomas Multi-Purpose Clamps	508
Passow Tampers-Osteotomes	449	Probes	99
		Probes Ear Sickle Knives	276

Providence-Hospital Delicate Haemostatic Forceps	221	Rosenberg Exchangeable Tips	400
Putti Bone File and Rasps	477	Roser-Konig Mouth Gags	393
Q		Ross Retractors	127
Quervain Bone Lever	467	Rotocrette Vacuum Curettes	325
Quervain Osteotomes	448	Rottgen-Ruskin Bone Rongeurs	424
R		Round Pliers	418
Ragnell Dissecting Scissors	56	Roux Retractors	141
Ragnell-Davis Hooklets	139	Roux-Mini Retractors	141
Ralk Cilia Forceps	67	Rowe Disimpaction Forceps	390
Rampley Sponge Forceps	176	Rowe Orbital Hook	389
Randall Biopsy Curettes	326	Rowe Wire Pushers	391
Randall Gall Stone Forceps	161	Rubin Septum Forceps	290
Randall Kidney Stone Forceps	160	Rudd Hemorrhoidal Ligator	206
Raney Applying Forceps	330	Rumel Dissecting Forceps	238
Rankin Haemostatic Forceps	511	Rumel-Belebont Tourniquets	387
Raspatory Micro Ear Raspatories	276	Ruskin Bone Rongeurs	424
Razor Blades	01	Ruskin-Liston Bone Cutting Forceps	442
Recamier Uterine Curettes	322	Russ.Modell Lun Dissecting Forceps	66
Redon Cervical Vertebral Column	554	Ryder Needle Holders	92
Rees Face-lift Scissors	51	Ryder-Vascular Needle Holders	91
Reill Bone Holding Forceps	407	S	
Reill Drilling Chucks	484	Sachs Dura Dissectors	338
Reill Wire Cutting Forceps	434	Sachs Dura Hooks	333
Resano Intestinal Clamps	197	Salenius Meniscus Knives	491,493
Resection Knives	07	Salyer Cleft Palate Instruments	384,383
Reverdin Abdominal Intestinal Spatulas	159	Samii Grasping Tissue Forceps	65
Reverdin Suture Instruments	88	Sanger Ovum Forceps	260
Reynolds Dissecting Scissors	26	Sarot Needle Holders	90
Ricard Abdominal Retractors	154	Sarot Tonsil Forceps	237
Richardson Retractors	119	Satinsky Multi-Purpose Clamps	519
Richardson-Eastman Retractors	119	Satinsky Vessel Scissors	31
Robb Vascular Dilators	385	Sauerbruch Retractors	114
Robin Towel Clamps	244	Saupe Splinter Forceps	67
Rochard Abdominal Retractors	136	Scalp Contour Retractors For Cervical Vertebral Column	363
Rochester-Carmalt Delicate Haemostatic Forceps	224	Scalpel Handle	04,05
Roeder Towel Clamps	245	Scalpels, Tenotomes	06
Rogers Vaginal Clamps	251	Schaaf Splinter Forceps	67
Rollet Fine Wound Retractors	103	Schaedel Towel Clamps	245
Roschke Pylorus Clamps	203	Schede Bone Curettes	456
Rose Retractors	142	Scheibe Intestinal Grasping Forceps	184
Rosen Circular cutting Knife	276		

Scheinmann Exchangeable Tips	399	Semb Rib Raspatories	465
Scherback Vaginal Speculas	301	Semken Delicate Dissecting Forceps	61
Schink Dermatomes	09	Semken Tissue Forceps	63
Schmid Aortic Dilators	383	Semken Tungsten Carbide Inserts Forceps	70
Schmid Grasping Forceps	384	Semm Abdominal Retractors	157
Schmieden Guiding Probes	85	Semm Vaginal Specula	293
Schmieden-Dick Ligature Needles	77	Senn-Green Hooklets	139
Schneider Rib Raspatories	465	Senn-Miller Retractors	140
Schmidt Delicate Haemostatic Forceps	223	Setter Bone Holding Forceps	408
Schoemaker-Loth Ligature Scissors	29	Seutin Plaster Scissors	264
Schoemaker-Loth Needle Holders	78	Sewall Raspatories	470
Schoenborn Retractors	108	Sewall Septum Elevators	285
Schroder Uterine Scoops	321	Seyffert Vaginal Specula	293
Schroeder Uterine Tenaculum Forceps	310,311	Shambaugh Hooks	277
Schubert Biopsy Forceps	318	Sharp Tonsil Knives	284
Schulz Aortic Dilators	382	Sickle Tonsil Knives	284
Schulze-Bergmann Rectal Speculums	201	Siebold Operating Scissors	22
Schumacher Rib Shears	499	Silver Dermatomes	09
Schumancher Bone Lever	481	Simon Bone Curettes	459,460
Schumancher Exchangeable Tips	400	Simon Fistula Hooks	315
Schumasher Biopsy Forceps	316,319	Simon Retractors	104
Schwarz Traction Bows	489	Simon Retractors For Deep Surgery	125
Schwedisches Modell Needle Holders	92	Simon Uterine Scoops	321
Scoville Nerve Root Retractors	342	Simon Vaginal and Wound Retractor	303
Scoville-Haverfield Retractors For Cervical Vertebral Column	357	Simoson Uterine Sounds	308
Scoville-Richter Self-Retaining Retractors	151	Simpson-Braun Obstetrics-Forceps	256
Screw Driver Retractors For Cervical Vertebral Column	352,353	Sims Operating Scissors	20,21
Scudder Stomach Clamps	198	Sims Rectal Specula	202
Sedillot Raspatories	464	Sims Rectal Speculums	201
Segond Myoma Instruments	315	Sims Set Upper Blades	295
Seidl DBP Biopsy Forceps	319	Sims Uterine Curettes	322,323
Seidl Set Upper Blades	295	Sims Uterine Depressor	308
Seiffert Exchangeable Tips	399	Sims Uterine Scissors	52
Seiffert probes	100	Sims Uterine Sounds	308
Sellheim Ovum Forceps	260	Sims-Aquila Scissors	52
Sellers Rib Spreaders	506	Sims-Maier Sponge and Dressing Forceps	180
Semb Bone Holding Forceps	410	Sims-Siebold Operating Scissors	22
Semb Bone Rongeurs	425	Skene Uterine Tenaculum Forceps	312
Semb Hysterectomy Forceps	253	Skull Traction Tongs	328
Semb Multi-Purpose Clamps	213	Smellie Ovum Cranioclast	258
Semb Respositioning Forceps	410	Smillie Meniscus Knives	493

Townsend Biopsy Forceps	320
Townsend-Krause Biopsy Forceps	320
Townsend-Tischler Biopsy Forceps	320
Travers Self-Retaining Retractors	145
Trelat Raspatories	468
Troeltsch Bayonet-Shaped Forceps	59
Troeltsch Tissue Forceps	63
Trousseau Clip Applying Forceps	382
Trousseau Dilators	403
Troutman-Chris Razor Blades	01
Tubbs Aortic Dilators	382
Tubing Clamps	254
Tuffier Abdominal Intestinal Spatulas	159
Tuffier Haemostatic Forceps	217
Tuffier Rib Retractors	505
Turnable Biopsy Forceps	208
Tuttle Lun Dissecting Forceps	66
Twist Drill Retractors For Cervical Vertebral Column	352,353
Tyding Clip Applying Forceps	380

U

Ueckermann-Denker Tracheal Tubes	404
Uffenorde Bone Curettes	463
Ulrich Bone Holding Forceps	411
Ulrich Dressing Forceps	177,178
Universal Plaster Instruments	262
universal Scissors	56
Us-Army Retractors	142

V

Valleix Uterine Sounds	308
Van Buren Bone Holding Forceps	409
Van Doren Biopsy Forceps	319
Veidenheimer Intestinal Clamps	197
Verbrugge Bone Holding Forceps	415
Verbrugge-Muller Bone Lever	480
Vikers Mallets	429
Virchow Knives	02
Vise Grip Pliers	418
Volkman Bone Curettes	456,461,462
Volkman Retractors	110,112

W

Wachenfeldt Clip Applying Forceps	102,77
Wagener Ear Loops-Hooks	282
Wagener Vessel Hooks	331
Wagner Bone Lever	419
Wagner Dissecting Scissors	24
Wagner Mallets	427
Wagner Meniscus Knives	492
Wagner Raspatories	445
Wagner Retractors For Cervical Vertebral Column	373
Walter Osteotomes Chisels	450
Wangensteen Needle Holders	82,92
Wangensteen Tungsten Carbide Inserts Forceps	70
Waugh Tissue Forceps	63
Weber Aorta-Anastomosis Clamps	533
Webster Needle Holders	81,89
Weil-Blakesley Nasal Cutting Forceps	272
Weil-Blakesley Rongeurs	376
Weissbarth Vaginal Specula	302
Weitlaner Retractors For Cervical Vertebral Column	360,361
Weitlaner Self-Retaining Retractors	144,146
Weller Cartilage Forceps	416
Wertheim Gynaecology Scissors	21
Wertheim Hysterectomy Forceps	247,248,249
Wertheim Vena-Cava Clamps	529
Wertheim-Cullen Hysterectomy Forceps	248
Westmacott Nasal Dressing Forceps	280
Weston Biopsy Forceps	386
White Clip Applying Forceps	382
Wieder Tongue Depressors	402
Wiener Model Guiding Probes	86
Wikstroem Hysterectomy Forceps	253
Wikstroem Multi-Purpose Clamps	213
Wilde Bayonet-Shaped Forceps	59
Willett Ovum Forceps	260
Williams Retractors For Cervical Vertebral Column	356
Williams Tissue Grasping Forceps	185
Williger Bone Curettes	456,461,462
Williger Elevators	467
Williger Mallets	433,432

Williger Periosteal Elevators	474	Zielker Osteotomes	447
Williger Raspatories	468	Zoellner Cervical Vertebral Column	555
Williger Retractors	107	Zollner Ear Specula	275
Winter Ovum Forceps	257	Zweifel Needle Holders	95
Wire Cutters	496		
Wire Cutting Forceps	435,433		
Wire Cutting Scissors	496		
Wire Extension	487,488		
Wire Guide Micro Ear Raspatories	276		
Wire Holding Forceps	418		
Wire Tightening Pliers	497		
Witner Biopsy Forceps	317		
Wolff Plaster Breakers	268		
Wound-Trachea Retractors	106		
Wrigley Obstetrics-Forceps	256		
Wullstein Cervical Vertebral Column	555		
Wullstein Suction Instruments	563		
Wylie Aorta-Anastomosis Clamps	534		
Wylie Aortic Clamps	548		

Y

Yankauer Cervical Vertebral Column	559
Yankauer Suction Instruments	561
Yasargil Cervical Vertebral Column	556
Yasargil Combined Suction	564
Yasargil Dura Dissectors	337
Yasargil Dura Hooks	336
Yasargil Haemostatic Forceps	243
Yasargil Micro Forceps	60
Yasargil Micro Needle Holders	84
Yasargil Suction Instruments	563
Yasargil Tumors Forceps	65
Yasargil-Sami Forceps	65
Yeoman Biopsy Forceps	208
Young Kidney Stone Forceps	167
Young Prostatic Retractors	169

Z

Zenker Dissecting Forceps	238
Zenker Langenback Retractors	113
Zenker Spatulas Retractors	123

01-1001	01	01-1060	07	02-1038	11	02-1097	14	02-1156	19	02-1215	28
01-1002	01	01-1061	07	02-1039	11	02-1098	15	02-1157	19	02-1216	28
01-1003	01	01-1062	07	02-1040	11	02-1099	15	02-1158	19	02-1217	28
01-1004	01	01-1063	07	02-1041	12	02-1100	15	02-1159	19	02-1218	29
01-1005	01	01-1064	07	02-1042	12	02-1101	15	02-1160	20	02-1219	29
01-1006	02	01-1065	07	02-1043	12	02-1102	15	02-1161	20	02-1220	29
01-1007	02	01-1066	07	02-1044	12	02-1103	15	02-1162	20	02-1221	29
01-1008	02	01-1067	08	02-1045	12	02-1104	15	02-1163	20	02-1222	29
01-1009	02	01-1068	08	02-1046	12	02-1105	15	02-1164	20	02-1223	30
01-1010	02	01-1069	08	02-1047	12	02-1106	15	02-1165	20	02-1224	30
01-1011	03	01-1070	08	02-1048	12	02-1107	15	02-1166	20	02-1225	30
01-1012	03	01-1071	08	02-1049	13	02-1108	15	02-1167	20	02-1226	30
01-1013	03	01-1072	08	02-1050	13	02-1109	15	02-1168	20	02-1227	30
01-1014	03	01-1073	08	02-1051	13	02-1110	15	02-1169	20	02-1228	30
01-1015	03	01-1074	08	02-1052	13	02-1111	15	02-1170	21	02-1229	30
01-1016	03	01-1075	08	02-1053	13	02-1112	15	02-1171	21	02-1230	31
01-1017	03	01-1076	08	02-1054	13	02-1113	15	02-1172	21	02-1231	31
01-1018	03	01-1077	08	02-1055	13	02-1114	15	02-1173	21	02-1232	31
01-1019	03	01-1078	08	02-1056	13	02-1115	15	02-1174	21	02-1233	31
01-1020	03	01-1079	09	02-1057	13	02-1116	15	02-1175	21	02-1234	31
01-1021	04	01-1080	09	02-1058	13	02-1117	15	02-1176	22	02-1235	32
01-1022	04	01-1081	09	02-1059	13	02-1118	15	02-1177	22	02-1236	32
01-1023	04	02-1001	10	02-1060	13	02-1119	15	02-1178	22	02-1237	32
01-1024	04	02-1002	10	02-1061	13	02-1120	15	02-1179	23	02-1238	32
01-1025	04	02-1003	10	02-1062	13	02-1121	15	02-1180	23	02-1239	32
01-1026	04	02-1004	10	02-1063	13	02-1122	15	02-1181	23	02-1240	32
01-1027	04	02-1005	10	02-1064	13	02-1123	15	02-1182	23	02-1241	32
01-1028	04	02-1006	10	02-1065	13	02-1124	15	02-1183	23	02-1242	32
01-1029	04	02-1007	10	02-1066	13	02-1125	15	02-1184	24	02-1243	32
01-1030	05	02-1008	10	02-1067	13	02-1126	15	02-1185	24	02-1244	32
01-1031	05	02-1009	10	02-1068	13	02-1127	15	02-1186	24	02-1245	33
01-1032	05	02-1010	10	02-1069	13	02-1128	16	02-1187	24	02-1246	33
01-1033	05	02-1011	10	02-1070	13	02-1129	16	02-1188	24	02-1247	33
01-1034	05	02-1012	10	02-1071	13	02-1130	16	02-1189	24	02-1248	33
01-1035	05	02-1013	10	02-1072	13	02-1131	16	02-1190	25	02-1249	33
01-1036	05	02-1014	10	02-1073	13	02-1132	16	02-1191	25	02-1250	33
01-1037	06	02-1015	10	02-1074	13	02-1133	16	02-1192	25	02-1251	33
01-1038	06	02-1016	10	02-1075	13	02-1134	16	02-1193	25	02-1252	33
01-1039	06	02-1017	10	02-1076	13	02-1135	16	02-1194	25	02-1253	33
01-1040	06	02-1018	10	02-1077	14	02-1136	16	02-1195	26	02-1254	34
01-1041	06	02-1019	10	02-1078	14	02-1137	16	02-1196	26	02-1255	34
01-1042	06	02-1020	10	02-1079	14	02-1138	16	02-1197	26	02-1256	34
01-1043	06	02-1021	11	02-1080	14	02-1139	16	02-1198	26	02-1257	34
01-1044	06	02-1022	11	02-1081	14	02-1140	17	02-1199	26	02-1258	35
01-1045	06	02-1023	11	02-1082	14	02-1141	17	02-1200	26	02-1259	35
01-1046	06	02-1024	11	02-1083	14	02-1142	17	02-1201	26	02-1260	35
01-1047	06	02-1025	11	02-1084	14	02-1143	17	02-1202	26	02-1261	35
01-1048	06	02-1026	11	02-1085	14	02-1144	17	02-1203	26	02-1262	35
01-1049	06	02-1027	11	02-1086	14	02-1145	17	02-1204	26	02-1263	35
01-1050	06	02-1028	11	02-1087	14	02-1146	17	02-1205	26	02-1264	36
01-1051	06	02-1029	11	02-1088	14	02-1147	17	02-1206	27	02-1265	36
01-1052	06	02-1030	11	02-1089	14	02-1148	17	02-1207	27	02-1266	36
01-1053	06	02-1031	11	02-1090	14	02-1149	17	02-1208	27	02-1267	36
01-1054	06	02-1032	11	02-1091	14	02-1150	17	02-1209	27	02-1268	37
01-1055	06	02-1033	11	02-1092	14	02-1151	17	02-1210	27	02-1269	37
01-1056	07	02-1034	11	02-1093	14	02-1152	18	02-1211	28	02-1270	37
01-1057	06	02-1035	11	02-1094	14	02-1153	18	02-1212	28	02-1271	37
01-1058	07	02-1036	11	02-1095	14	02-1154	18	02-1213	28	02-1272	37
01-1059	07	02-1037	11	02-1096	14	02-1155	18	02-1214	28	02-1273	37

02-1274	38	02-1333	49	03-1018	58	03-1077	62	03-1136	65	03-1195	69
02-1275	38	02-1334	49	03-1019	58	03-1078	62	03-1137	65	03-1196	69
02-1276	38	02-1335	49	03-1020	58	03-1079	62	03-1138	65	03-1197	69
02-1277	38	02-1336	49	03-1021	58	03-1080	62	03-1139	65	03-1198	69
02-1278	38	02-1337	49	03-1022	58	03-1081	62	03-1140	65	03-1199	69
02-1279	38	02-1338	49	03-1023	58	03-1082	62	03-1141	65	03-1200	70
02-1280	39	02-1339	50	03-1024	59	03-1083	62	03-1142	65	03-1201	70
02-1281	39	02-1340	50	03-1025	59	03-1084	62	03-1143	66	03-1202	70
02-1282	39	02-1341	50	03-1026	59	03-1085	62	03-1144	66	03-1203	70
02-1283	39	02-1342	50	03-1027	59	03-1086	62	03-1145	66	03-1204	70
02-1284	40	02-1343	50	03-1028	59	03-1087	62	03-1146	66	03-1205	70
02-1285	40	02-1344	50	03-1029	59	03-1088	62	03-1147	66	03-1206	70
02-1286	40	02-1345	51	03-1030	59	03-1089	62	03-1148	66	03-1207	70
02-1287	40	02-1346	51	03-1031	59	03-1090	62	03-1149	66	03-1208	70
02-1288	40	02-1347	51	03-1032	59	03-1091	62	03-1150	66	03-1209	70
02-1289	40	02-1348	52	03-1033	59	03-1092	62	03-1151	66	03-1210	70
02-1290	41	02-1349	52	03-1034	60	03-1093	63	03-1152	66	03-1211	70
02-1291	41	02-1350	52	03-1035	60	03-1094	63	03-1153	66	03-1212	70
02-1292	41	02-1351	52	03-1036	60	03-1095	63	03-1154	66	03-1213	70
02-1293	41	02-1352	53	03-1037	60	03-1096	63	03-1155	66	03-1214	70
02-1294	41	02-1353	53	03-1038	60	03-1097	63	03-1156	66	03-1215	70
02-1295	41	02-1354	54	03-1039	60	03-1098	63	03-1157	66	03-1216	70
02-1296	42	02-1355	54	03-1040	60	03-1099	63	03-1158	67	03-1217	70
02-1297	42	02-1356	54	03-1041	60	03-1100	63	03-1159	67	03-1218	70
02-1298	42	02-1357	54	03-1042	60	03-1101	63	03-1160	67	03-1219	70
02-1299	42	02-1358	55	03-1043	60	03-1102	63	03-1161	67	03-1220	70
02-1300	43	02-1359	55	03-1044	60	03-1103	63	03-1162	67	03-1221	70
02-1301	43	02-1360	55	03-1045	60	03-1104	63	03-1163	67	03-1222	70
02-1302	43	02-1361	55	03-1046	60	03-1105	63	03-1164	67	03-1223	70
02-1303	43	02-1362	55	03-1047	60	03-1106	63	03-1165	67	03-1224	70
02-1304	44	02-1363	55	03-1048	60	03-1107	63	03-1166	67	03-1225	70
02-1305	44	02-1364	55	03-1049	60	03-1108	63	03-1167	67	03-1226	70
02-1306	44	02-1365	56	03-1050	60	03-1109	63	03-1168	67	03-1227	70
02-1307	44	02-1366	56	03-1051	60	03-1110	63	03-1169	67	03-1228	71
02-1308	44	02-1367	56	03-1052	61	03-1111	63	03-1170	67	03-1229	71
02-1309	44	02-1368	56	03-1053	61	03-1112	63	03-1171	67	03-1230	71
02-1310	45	02-1369	56	03-1054	61	03-1113	63	03-1172	67	03-1231	71
02-1311	45	02-1370	56	03-1055	61	03-1114	63	03-1173	68	03-1232	71
02-1312	45	02-1371	57	03-1056	61	03-1115	63	03-1174	68	03-1233	71
02-1313	45	02-1372	57	03-1057	61	03-1116	64	03-1175	68	03-1234	71
02-1314	45	02-1373	57	03-1058	61	03-1117	64	03-1176	68	03-1235	71
02-1315	45	02-1374	57	03-1059	61	03-1118	64	03-1177	68	03-1236	71
02-1316	46	03-1001	58	03-1060	61	03-1119	64	03-1178	68	03-1237	71
02-1317	46	03-1002	58	03-1061	61	03-1120	64	03-1179	68	03-1238	71
02-1318	46	03-1003	58	03-1062	61	03-1121	64	03-1180	68	03-1239	71
02-1319	46	03-1004	58	03-1063	61	03-1122	64	03-1181	68	03-1240	71
02-1320	46	03-1005	58	03-1064	61	03-1123	64	03-1182	69	04-1001	72
02-1321	47	03-1006	58	03-1065	61	03-1124	64	03-1183	69	04-1002	72
02-1322	47	03-1007	58	03-1066	62	03-1125	64	03-1184	69	04-1003	72
02-1323	47	03-1008	58	03-1067	62	03-1126	64	03-1185	69	04-1004	72
02-1324	47	03-1009	58	03-1068	62	03-1127	64	03-1186	69	04-1005	72
02-1325	47	03-1010	58	03-1069	62	03-1128	64	03-1187	69	04-1006	73
02-1326	48	03-1011	58	03-1070	62	03-1129	64	03-1188	69	04-1007	73
02-1327	48	03-1012	58	03-1071	62	03-1130	64	03-1189	69	04-1008	73
02-1328	48	03-1013	58	03-1072	62	03-1131	64	03-1190	69	04-1009	73
02-1329	48	03-1014	58	03-1073	62	03-1132	64	03-1191	69	04-1010	73
02-1330	48	03-1015	58	03-1074	62	03-1133	65	03-1192	69	04-1011	74
02-1331	48	03-1016	58	03-1075	62	03-1134	65	03-1193	69	04-1012	74
02-1332	49	03-1017	58	03-1076	62	03-1135	65	03-1194	69	04-1013	74

04-1014	74	04-1073	82	04-1132	89	04-1191	94	05-1023	99	06-1022	103
04-1015	74	04-1074	82	04-1133	89	04-1192	94	05-1024	99	06-1023	103
04-1016	74	04-1075	83	04-1134	89	04-1193	95	05-1025	99	06-1024	103
04-1017	75	04-1076	83	04-1135	90	04-1194	95	05-1026	99	06-1025	104
04-1018	75	04-1077	83	04-1136	90	04-1195	95	05-1027	99	06-1026	104
04-1019	75	04-1078	83	04-1137	90	04-1196	95	05-1028	99	06-1027	104
04-1020	75	04-1079	83	04-1138	90	04-1197	95	05-1029	100	06-1028	104
04-1021	75	04-1080	83	04-1139	90	04-1198	95	05-1030	100	06-1029	104
04-1022	75	04-1081	83	04-1140	90	04-1199	95	05-1031	100	06-1030	104
04-1023	76	04-1082	83	04-1141	90	04-1200	95	05-1032	100	06-1031	104
04-1024	76	04-1083	83	04-1142	91	04-1201	95	05-1033	100	06-1032	105
04-1025	76	04-1084	83	04-1143	91	04-1202	95	05-1034	100	06-1033	105
04-1026	76	04-1085	83	04-1144	91	04-1203	95	05-1035	100	06-1034	105
04-1027	76	04-1086	84	04-1145	91	04-1204	95	05-1036	100	06-1035	105
04-1028	76	04-1087	84	04-1146	91	04-1205	95	05-1037	100	06-1036	105
04-1029	77	04-1088	84	04-1147	91	04-1206	95	05-1038	100	06-1037	105
04-1030	77	04-1089	84	04-1148	91	04-1207	95	05-1039	100	06-1038	105
04-1031	77	04-1090	84	04-1149	91	04-1208	95	05-1040	101	06-1039	105
04-1032	77	04-1091	85	04-1150	91	04-1209	96	05-1041	101	06-1040	105
04-1033	77	04-1092	85	04-1151	91	04-1210	96	05-1042	101	06-1041	105
04-1034	77	04-1093	85	04-1152	91	04-1211	96	05-1043	101	06-1042	105
04-1035	78	04-1094	85	04-1153	91	04-1212	96	05-1044	101	06-1043	105
04-1036	78	04-1095	85	04-1154	91	04-1213	96	05-1045	101	06-1044	105
04-1037	78	04-1096	85	04-1155	91	04-1214	96	05-1046	101	06-1045	105
04-1038	78	04-1097	85	04-1156	91	04-1215	96	05-1047	101	06-1046	105
04-1039	78	04-1098	86	04-1157	91	04-1216	96	05-1048	101	06-1047	105
04-1040	78	04-1099	86	04-1158	91	04-1217	96	05-1049	101	06-1048	105
04-1041	78	04-1100	86	04-1159	91	04-1218	96	05-1050	101	06-1049	106
04-1042	78	04-1101	86	04-1160	91	04-1219	96	05-1051	101	06-1050	106
04-1043	79	04-1102	86	04-1161	91	04-1220	96	05-1052	101	06-1051	106
04-1044	79	04-1103	86	04-1162	91	04-1221	96	05-1053	102	06-1052	106
04-1045	79	04-1104	87	04-1163	92	04-1222	97	05-1054	102	06-1053	106
04-1046	79	04-1105	87	04-1164	92	04-1223	97	05-1055	102	06-1054	106
04-1047	79	04-1106	87	04-1165	92	04-1224	97	05-1056	102	06-1055	106
04-1048	79	04-1107	87	04-1166	92	04-1225	97	05-1057	102	06-1056	106
04-1049	79	04-1108	87	04-1167	92	04-1226	97	05-1058	102	06-1057	106
04-1050	79	04-1109	87	04-1168	92	04-1227	97	05-1059	102	06-1058	106
04-1051	79	04-1110	87	04-1169	92	05-1001	98	05-1060	102	06-1059	106
04-1052	79	04-1111	87	04-1170	92	05-1002	98	06-1001	103	06-1060	106
04-1053	80	04-1112	88	04-1171	92	05-1003	98	06-1002	103	06-1061	106
04-1054	80	04-1113	88	04-1172	92	05-1004	98	06-1003	103	06-1062	106
04-1055	80	04-1114	88	04-1173	92	05-1005	98	06-1004	103	06-1063	106
04-1056	80	04-1115	88	04-1174	92	05-1006	98	06-1005	103	06-1064	106
04-1057	81	04-1116	88	04-1175	92	05-1007	98	06-1006	103	06-1065	106
04-1058	81	04-1117	88	04-1176	92	05-1008	98	06-1007	103	06-1066	106
04-1059	81	04-1118	88	04-1177	92	05-1009	98	06-1008	103	06-1067	106
04-1060	81	04-1119	88	04-1178	92	05-1010	98	06-1009	103	06-1068	106
04-1061	81	04-1120	88	04-1179	93	05-1011	98	06-1010	103	06-1069	106
04-1062	81	04-1121	88	04-1180	93	05-1012	98	06-1011	103	06-1070	106
04-1063	82	04-1122	88	04-1181	93	05-1013	99	06-1012	103	06-1071	106
04-1064	82	04-1123	88	04-1182	93	05-1014	99	06-1013	103	06-1072	106
04-1065	82	04-1124	89	04-1183	93	05-1015	99	06-1014	103	06-1073	106
04-1066	82	04-1125	89	04-1184	93	05-1016	99	06-1015	103	06-1074	107
04-1067	82	04-1126	89	04-1185	93	05-1017	99	06-1016	103	06-1075	107
04-1068	82	04-1127	89	04-1186	94	05-1018	99	06-1017	103	06-1076	107
04-1069	82	04-1128	89	04-1187	94	05-1019	99	06-1018	103	06-1077	107
04-1070	82	04-1129	89	04-1188	94	05-1020	99	06-1019	103	06-1078	107
04-1071	82	04-1130	89	04-1189	94	05-1021	99	06-1020	103	06-1079	107
04-1072	82	04-1131	89	04-1190	94	05-1022	99	06-1021	103	06-1080	107

06-1081	107	06-1140	112	06-1199	117	06-1258	128	06-1317	141	06-1376	151
06-1082	107	06-1141	112	06-1200	117	06-1259	128	06-1318	141	06-1377	151
06-1083	107	06-1142	112	06-1201	118	06-1260	129	06-1319	141	06-1378	152
06-1084	107	06-1143	112	06-1202	118	06-1261	129	06-1320	141	06-1379	152
06-1085	107	06-1144	112	06-1203	118	06-1262	129	06-1321	141	06-1380	152
06-1086	107	06-1145	112	06-1204	118	06-1263	130	06-1322	141	06-1381	152
06-1087	107	06-1146	112	06-1205	118	06-1264	130	06-1323	141	06-1382	152
06-1088	108	06-1147	112	06-1206	118	06-1265	131	06-1324	141	06-1383	152
06-1089	108	06-1148	112	06-1207	119	06-1266	131	06-1325	142	06-1384	152
06-1090	108	06-1149	112	06-1208	119	06-1267	132	06-1326	142	06-1385	152
06-1091	108	06-1150	112	06-1209	119	06-1268	132	06-1327	142	06-1386	152
06-1092	108	06-1151	112	06-1210	119	06-1269	132	06-1328	142	06-1387	152
06-1093	108	06-1152	112	06-1211	119	06-1270	133	06-1329	142	06-1388	153
06-1094	108	06-1153	112	06-1212	120	06-1271	133	06-1330	142	06-1389	153
06-1095	108	06-1154	112	06-1213	120	06-1272	134	06-1331	142	06-1390	153
06-1096	108	06-1155	112	06-1214	120	06-1273	134	06-1332	143	06-1391	153
06-1097	108	06-1156	112	06-1215	120	06-1274	134	06-1333	143	06-1392	153
06-1098	108	06-1157	112	06-1216	120	06-1275	134	06-1334	143	06-1393	154
06-1099	108	06-1158	112	06-1217	120	06-1276	135	06-1335	143	06-1394	154
06-1100	108	06-1159	112	06-1218	121	06-1277	135	06-1336	143	06-1395	154
06-1101	108	06-1160	113	06-1219	121	06-1278	135	06-1337	143	06-1396	154
06-1102	108	06-1161	113	06-1220	121	06-1279	135	06-1338	143	06-1397	154
06-1103	108	06-1162	113	06-1221	121	06-1280	135	06-1339	143	06-1398	154
06-1104	108	06-1163	113	06-1222	121	06-1281	135	06-1340	143	06-1399	154
06-1105	108	06-1164	113	06-1223	121	06-1282	135	06-1341	143	06-1400	154
06-1106	108	06-1165	113	06-1224	122	06-1283	136	06-1342	143	06-1401	154
06-1107	109	06-1166	114	06-1225	122	06-1284	136	06-1343	144	06-1402	154
06-1108	109	06-1167	114	06-1226	122	06-1285	136	06-1344	144	06-1403	154
06-1109	109	06-1168	114	06-1227	123	06-1286	136	06-1345	144	06-1404	154
06-1110	109	06-1169	114	06-1228	123	06-1287	136	06-1346	144	06-1405	154
06-1111	109	06-1170	114	06-1229	123	06-1288	136	06-1347	144	06-1406	155
06-1112	109	06-1171	114	06-1230	123	06-1289	136	06-1348	144	06-1407	155
06-1113	109	06-1172	114	06-1231	123	06-1290	136	06-1349	145	06-1408	155
06-1114	109	06-1173	114	06-1232	124	06-1291	136	06-1350	145	06-1409	155
06-1115	109	06-1174	115	06-1233	124	06-1292	136	06-1351	145	06-1410	155
06-1116	109	06-1175	115	06-1234	124	06-1293	136	06-1352	145	06-1411	155
06-1117	109	06-1176	115	06-1235	125	06-1294	136	06-1353	146	06-1412	156
06-1118	109	06-1177	115	06-1236	125	06-1295	137	06-1354	146	06-1413	156
06-1119	110	06-1178	115	06-1237	125	06-1296	137	06-1355	146	06-1414	156
06-1120	110	06-1179	115	06-1238	125	06-1297	137	06-1356	146	06-1415	156
06-1121	110	06-1180	115	06-1239	126	06-1298	138	06-1357	146	06-1416	156
06-1122	110	06-1181	115	06-1240	126	06-1299	138	06-1358	146	06-1417	156
06-1123	110	06-1182	115	06-1241	126	06-1300	138	06-1359	147	06-1418	156
06-1124	110	06-1183	115	06-1242	126	06-1301	138	06-1360	147	06-1419	156
06-1125	110	06-1184	115	06-1243	126	06-1302	139	06-1361	147	06-1420	156
06-1126	110	06-1185	115	06-1244	126	06-1303	139	06-1362	148	06-1421	156
06-1127	110	06-1186	115	06-1245	126	06-1304	139	06-1363	148	06-1422	156
06-1128	110	06-1187	115	06-1246	126	06-1305	139	06-1364	148	06-1423	157
06-1129	110	06-1188	116	06-1247	127	06-1306	139	06-1365	149	06-1424	157
06-1130	110	06-1189	116	06-1248	127	06-1307	140	06-1366	149	06-1425	157
06-1131	110	06-1190	116	06-1249	127	06-1308	140	06-1367	149	06-1426	157
06-1132	111	06-1191	116	06-1250	127	06-1309	140	06-1368	149	06-1427	157
06-1133	111	06-1192	116	06-1251	127	06-1310	140	06-1369	150	06-1428	157
06-1134	111	06-1193	117	06-1252	127	06-1311	140	06-1370	150	06-1429	158
06-1135	111	06-1194	117	06-1253	127	06-1312	140	06-1371	150	06-1430	158
06-1136	111	06-1195	117	06-1254	127	06-1313	140	06-1372	150	06-1431	158
06-1137	111	06-1196	117	06-1255	127	06-1314	140	06-1373	150	06-1432	158
06-1138	112	06-1197	117	06-1256	127	06-1315	140	06-1374	151	06-1433	158
06-1139	112	06-1198	117	06-1257	128	06-1316	140	06-1375	151	06-1434	158

06-1435	158	07-1049	171	07-1108	174	07-1167	174	09-1002	184	09-1061	190
06-1436	158	07-1050	172	07-1109	174	07-1168	174	09-1003	184	09-1062	190
06-1437	158	07-1051	172	07-1110	174	07-1169	174	09-1004	184	09-1063	190
06-1438	158	07-1052	172	07-1111	174	07-1170	174	09-1005	184	09-1064	191
06-1439	158	07-1053	172	07-1112	174	07-1171	174	09-1006	184	09-1065	191
06-1440	159	07-1054	172	07-1113	174	07-1172	174	09-1007	184	09-1066	191
06-1441	159	07-1055	172	07-1114	174	07-1173	174	09-1008	184	09-1067	191
06-1442	159	07-1056	172	07-1115	174	07-1174	174	09-1009	184	09-1068	191
06-1443	159	07-1057	172	07-1116	174	07-1175	174	09-1010	184	09-1069	191
06-1444	159	07-1058	172	07-1117	174	07-1176	174	09-1011	185	09-1070	191
06-1445	159	07-1059	172	07-1118	174	07-1177	174	09-1012	185	09-1071	191
07-1001	160	07-1060	172	07-1119	174	07-1178	174	09-1013	185	09-1072	192
07-1002	160	07-1061	172	07-1120	174	08-1001	175	09-1014	185	09-1073	192
07-1003	160	07-1062	172	07-1121	174	08-1002	175	09-1015	185	09-1074	193
07-1004	160	07-1063	172	07-1122	174	08-1003	175	09-1016	185	09-1075	193
07-1005	160	07-1064	172	07-1123	174	08-1004	175	09-1017	185	09-1076	194
07-1006	160	07-1065	172	07-1124	174	08-1005	176	09-1018	185	09-1077	194
07-1007	161	07-1066	172	07-1125	174	08-1006	176	09-1019	185	09-1078	194
07-1008	161	07-1067	172	07-1126	174	08-1007	176	09-1020	185	09-1079	195
07-1009	161	07-1068	172	07-1127	174	08-1008	177	09-1021	185	09-1080	195
07-1010	161	07-1069	172	07-1128	174	08-1009	177	09-1022	185	09-1081	195
07-1011	162	07-1070	172	07-1129	174	08-1010	178	09-1023	186	09-1082	196
07-1012	162	07-1071	172	07-1130	174	08-1011	178	09-1024	186	09-1083	196
07-1013	163	07-1072	172	07-1131	174	08-1012	179	09-1025	186	09-1084	196
07-1014	163	07-1073	172	07-1132	174	08-1013	179	09-1026	186	09-1085	197
07-1015	163	07-1074	172	07-1133	174	08-1014	179	09-1027	186	09-1086	197
07-1016	163	07-1075	172	07-1134	174	08-1015	179	09-1028	186	09-1087	198
07-1017	164	07-1076	172	07-1135	174	08-1016	179	09-1029	186	09-1088	198
07-1018	164	07-1077	172	07-1136	174	08-1017	179	09-1030	186	09-1089	198
07-1019	164	07-1078	172	07-1137	174	08-1018	180	09-1031	186	09-1090	198
07-1020	164	07-1079	172	07-1138	174	08-1019	180	09-1032	186	09-1091	199
07-1021	164	07-1080	172	07-1139	174	08-1020	180	09-1033	186	09-1092	199
07-1022	165	07-1081	172	07-1140	174	08-1021	180	09-1034	186	09-1093	199
07-1023	165	07-1082	172	07-1141	174	08-1022	180	09-1035	186	09-1094	199
07-1024	165	07-1083	172	07-1142	174	08-1023	180	09-1036	186	09-1095	200
07-1025	166	07-1084	172	07-1143	174	08-1024	180	09-1037	186	09-1096	200
07-1026	166	07-1085	172	07-1144	174	08-1025	180	09-1038	186	09-1097	200
07-1027	166	07-1086	172	07-1145	174	08-1026	180	09-1039	187	09-1098	200
07-1028	167	07-1087	172	07-1146	174	08-1027	180	09-1040	187	09-1099	200
07-1029	167	07-1088	172	07-1147	174	08-1028	180	09-1041	187	09-1100	200
07-1030	167	07-1089	172	07-1148	174	08-1029	180	09-1042	187	09-1101	200
07-1031	167	07-1090	172	07-1149	174	08-1030	180	09-1043	187	09-1102	200
07-1032	167	07-1091	172	07-1150	174	08-1031	180	09-1044	187	09-1103	200
07-1033	167	07-1092	172	07-1151	174	08-1032	181	09-1045	187	09-1104	200
07-1034	168	07-1093	172	07-1152	174	08-1033	181	09-1046	187	09-1105	201
07-1035	168	07-1094	172	07-1153	174	08-1034	181	09-1047	187	09-1106	201
07-1036	168	07-1095	172	07-1154	174	08-1035	181	09-1048	188	09-1107	201
07-1037	169	07-1096	172	07-1155	174	08-1036	181	09-1049	188	09-1108	201
07-1038	169	07-1097	172	07-1156	174	08-1037	181	09-1050	188	09-1109	201
07-1039	169	07-1098	173	07-1157	174	08-1038	182	09-1051	188	09-1110	201
07-1040	169	07-1099	173	07-1158	174	08-1039	182	09-1052	189	09-1111	202
07-1041	169	07-1100	173	07-1159	174	08-1040	182	09-1053	189	09-1112	202
07-1042	170	07-1101	173	07-1160	174	08-1041	182	09-1054	189	09-1113	202
07-1043	170	07-1102	173	07-1161	174	08-1042	183	09-1055	189	09-1114	202
07-1044	170	07-1103	173	07-1162	174	08-1043	183	09-1056	190	09-1115	202
07-1045	170	07-1104	173	07-1163	174	08-1044	183	09-1057	190	09-1116	202
07-1046	170	07-1105	174	07-1164	174	08-1045	183	09-1058	190	09-1117	203
07-1047	171	07-1106	174	07-1165	174	08-1046	183	09-1059	190	09-1118	203
07-1048	171	07-1107	174	07-1166	174	09-1001	184	09-1060	190	09-1119	203

15-1604	371	16-1010	378	16-1069	389	16-1128	398	16-1187	404	17-1038	412
15-1605	371	16-1011	378	16-1070	389	16-1129	398	16-1188	404	17-1039	412
15-1606	372	16-1012	378	16-1071	389	16-1130	398	16-1189	404	17-1040	412
15-1607	372	16-1013	379	16-1072	390	16-1131	398	16-1190	404	17-1041	412
15-1608	372	16-1014	379	16-1073	390	16-1132	399	16-1191	404	17-1042	412
15-1609	372	16-1015	379	16-1074	390	16-1133	399	16-1192	404	17-1043	412
15-1610	373	16-1016	379	16-1075	390	16-1134	399	16-1193	404	17-1044	412
15-1611	373	16-1017	379	16-1076	390	16-1135	399	16-1194	404	17-1045	412
15-1612	373	16-1018	379	16-1077	390	16-1136	399	16-1195	404	17-1046	412
15-1613	373	16-1019	379	16-1078	391	16-1137	399	16-1196	404	17-1047	413
15-1614	373	16-1020	379	16-1079	391	16-1138	399	16-1197	404	17-1048	413
15-1615	373	16-1021	380	16-1080	391	16-1139	399	16-1198	404	17-1049	413
15-1616	373	16-1022	380	16-1081	391	16-1140	399	16-1199	404	17-1050	414
15-1617	373	16-1023	380	16-1082	391	16-1141	399	16-1200	404	17-1051	414
15-1618	373	16-1024	380	16-1083	392	16-1142	400	16-1201	404	17-1052	414
15-1619	373	16-1025	380	16-1084	392	16-1143	400	16-1202	404	17-1053	414
15-1620	373	16-1026	381	16-1085	392	16-1144	400	16-1203	404	17-1054	415
15-1621	373	16-1027	381	16-1086	392	16-1145	400	16-1204	404	17-1055	415
15-1622	373	16-1028	381	16-1087	392	16-1146	400	16-1205	404	17-1056	415
15-1623	373	16-1029	381	16-1088	392	16-1147	400	16-1206	404	17-1057	415
15-1624	373	16-1030	381	16-1089	392	16-1148	400	16-1207	404	17-1058	415
15-1625	373	16-1031	381	16-1090	393	16-1149	400	16-1208	404	17-1059	415
15-1626	373	16-1032	381	16-1091	393	16-1150	400	17-1001	405	17-1060	415
15-1627	373	16-1033	382	16-1092	393	16-1151	400	17-1002	405	17-1061	415
15-1628	373	16-1034	382	16-1093	393	16-1152	400	17-1003	405	17-1062	415
15-1629	373	16-1035	382	16-1094	393	16-1153	400	17-1004	405	17-1063	416
15-1630	373	16-1036	382	16-1095	393	16-1154	401	17-1005	405	17-1064	416
15-1631	373	16-1037	382	16-1096	393	16-1155	401	17-1006	406	17-1065	416
15-1632	373	16-1038	382	16-1097	394	16-1156	401	17-1007	406	17-1066	416
15-1633	373	16-1039	383	16-1098	394	16-1157	401	17-1008	406	17-1067	416
15-1634	373	16-1040	383	16-1099	394	16-1158	401	17-1009	406	17-1068	416
15-1635	373	16-1041	383	16-1100	395	16-1159	401	17-1010	406	17-1069	417
15-1636	373	16-1042	383	16-1101	395	16-1160	401	17-1011	406	17-1070	417
15-1637	374	16-1043	384	16-1102	395	16-1161	402	17-1012	406	17-1071	417
15-1638	374	16-1044	384	16-1103	395	16-1162	402	17-1013	407	17-1072	417
15-1639	374	16-1045	384	16-1104	395	16-1163	402	17-1014	407	17-1073	418
15-1640	375	16-1046	384	16-1105	395	16-1164	402	17-1015	407	17-1074	418
15-1641	375	16-1047	384	16-1106	395	16-1165	402	17-1016	407	17-1075	418
15-1642	375	16-1048	385	16-1107	395	16-1166	403	17-1017	407	17-1076	418
15-1643	375	16-1049	385	16-1108	396	16-1167	403	17-1018	407	17-1077	418
15-1644	376	16-1050	385	16-1109	396	16-1168	403	17-1019	408	17-1078	418
15-1645	376	16-1051	385	16-1110	396	16-1169	403	17-1020	408	17-1079	418
15-1646	376	16-1052	386	16-1111	396	16-1170	403	17-1021	408	17-1080	418
15-1647	376	16-1053	386	16-1112	396	16-1171	403	17-1022	408	17-1081	418
15-1648	376	16-1054	386	16-1113	396	16-1172	403	17-1023	408	17-1082	418
15-1649	376	16-1055	386	16-1114	396	16-1173	403	17-1024	408	17-1083	419
15-1650	376	16-1056	387	16-1115	396	16-1174	403	17-1025	408	17-1084	419
15-1651	376	16-1057	387	16-1116	396	16-1175	403	17-1026	409	17-1085	419
15-1652	376	16-1058	387	16-1117	396	16-1176	403	17-1027	409	17-1086	419
15-1653	376	16-1059	387	16-1118	396	16-1177	404	17-1028	409	17-1087	419
16-1001	377	16-1060	387	16-1119	396	16-1178	404	17-1029	409	17-1088	419
16-1002	377	16-1061	388	16-1120	397	16-1179	404	17-1030	410	17-1089	419
16-1003	377	16-1062	388	16-1121	397	16-1180	404	17-1031	410	17-1090	419
16-1004	377	16-1063	388	16-1122	397	16-1181	404	17-1032	411	17-1091	420
16-1005	377	16-1064	388	16-1123	397	16-1182	404	17-1033	411	17-1092	420
16-1006	378	16-1065	388	16-1124	397	16-1183	404	17-1034	411	17-1093	420
16-1007	378	16-1066	388	16-1125	397	16-1184	404	17-1035	411	17-1094	420
16-1008	378	16-1067	388	16-1126	397	16-1185	404	17-1036	411	17-1095	420
16-1009	378	16-1068	389	16-1127	398	16-1186	404	17-1037	411	17-1096	420

17-1806	490	18-1012	500	18-1071	510	18-1130	516	18-1189	529	18-1248	542
17-1807	490	18-1013	500	18-1072	510	18-1131	516	18-1190	529	18-1249	542
17-1808	490	18-1014	500	18-1073	510	18-1132	517	18-1191	529	18-1250	542
17-1809	490	18-1015	500	18-1074	510	18-1133	517	18-1192	529	18-1251	542
17-1810	490	18-1016	500	18-1075	510	18-1134	517	18-1193	530	18-1252	542
17-1811	490	18-1017	500	18-1076	510	18-1135	517	18-1194	530	18-1253	543
17-1812	491	18-1018	500	18-1077	510	18-1136	517	18-1195	530	18-1254	543
17-1813	491	18-1019	500	18-1078	510	18-1137	517	18-1196	530	18-1255	543
17-1814	491	18-1020	501	18-1079	510	18-1138	518	18-1197	530	18-1256	543
17-1815	491	18-1021	501	18-1080	510	18-1139	518	18-1198	531	18-1257	543
17-1816	491	18-1022	502	18-1081	510	18-1140	518	18-1199	531	18-1258	543
17-1817	491	18-1023	502	18-1082	510	18-1141	518	18-1200	532	18-1259	543
17-1818	491	18-1024	502	18-1083	510	18-1142	519	18-1201	532	18-1260	543
17-1819	491	18-1025	502	18-1084	510	18-1143	519	18-1202	532	18-1261	543
17-1820	492	18-1026	502	18-1085	510	18-1144	519	18-1203	532	18-1262	543
17-1821	492	18-1027	502	18-1086	510	18-1145	520	18-1204	532	18-1263	544
17-1822	492	18-1028	503	18-1087	510	18-1146	520	18-1205	533	18-1264	544
17-1823	492	18-1029	503	18-1088	510	18-1147	520	18-1206	533	18-1265	544
17-1824	493	18-1030	504	18-1089	510	18-1148	521	18-1207	534	18-1266	544
17-1825	493	18-1031	504	18-1090	510	18-1149	521	18-1208	534	18-1267	545
17-1826	493	18-1032	505	18-1091	511	18-1150	521	18-1209	534	18-1268	545
17-1827	493	18-1033	505	18-1092	511	18-1151	521	18-1210	535	18-1269	545
17-1828	494	18-1034	505	18-1093	511	18-1152	521	18-1211	535	18-1270	545
17-1829	494	18-1035	506	18-1094	511	18-1153	522	18-1212	535	18-1271	545
17-1830	494	18-1036	506	18-1095	511	18-1154	522	18-1213	536	18-1272	545
17-1831	494	18-1037	506	18-1096	511	18-1155	522	18-1214	536	18-1273	546
17-1832	494	18-1038	506	18-1097	511	18-1156	522	18-1215	536	18-1274	546
17-1833	494	18-1039	507	18-1098	511	18-1157	522	18-1216	536	18-1275	546
17-1834	494	18-1040	507	18-1099	512	18-1158	522	18-1217	536	18-1276	546
17-1835	494	18-1041	508	18-1100	512	18-1159	522	18-1218	536	18-1277	546
17-1836	495	18-1042	508	18-1101	512	18-1160	522	18-1219	537	18-1278	546
17-1837	495	18-1043	508	18-1102	512	18-1161	523	18-1220	537	18-1279	546
17-1838	496	18-1044	509	18-1103	512	18-1162	523	18-1221	537	18-1280	546
17-1839	496	18-1045	509	18-1104	512	18-1163	523	18-1222	537	18-1281	547
17-1840	496	18-1046	510	18-1105	512	18-1164	523	18-1223	538	18-1282	547
17-1841	496	18-1047	510	18-1106	512	18-1165	523	18-1224	538	18-1283	547
17-1842	496	18-1048	510	18-1107	512	18-1166	523	18-1225	538	18-1284	547
17-1843	496	18-1049	510	18-1108	512	18-1167	524	18-1226	538	18-1285	547
17-1844	496	18-1050	510	18-1109	513	18-1168	524	18-1227	538	18-1286	547
17-1845	496	18-1051	510	18-1110	513	18-1169	524	18-1228	539	18-1287	548
17-1846	497	18-1052	510	18-1111	513	18-1170	524	18-1229	539	18-1288	548
17-1847	497	18-1053	510	18-1112	513	18-1171	524	18-1230	539	18-1289	549
17-1848	497	18-1054	510	18-1113	513	18-1172	525	18-1231	539	18-1290	549
17-1849	497	18-1055	510	18-1114	514	18-1173	525	18-1232	540	18-1291	549
17-1850	497	18-1056	510	18-1115	514	18-1174	525	18-1233	540	18-1292	549
17-1851	497	18-1057	510	18-1116	514	18-1175	525	18-1234	540	18-1293	549
17-1852	497	18-1058	510	18-1117	514	18-1176	525	18-1235	540	18-1294	549
17-1853	497	18-1059	510	18-1118	514	18-1177	525	18-1236	541	18-1295	550
18-1001	498	18-1060	510	18-1119	514	18-1178	525	18-1237	541	18-1296	550
18-1002	498	18-1061	510	18-1120	514	18-1179	525	18-1238	541	18-1297	550
18-1003	498	18-1062	510	18-1121	514	18-1180	525	18-1239	541	18-1298	550
18-1004	498	18-1063	510	18-1122	515	18-1181	526	18-1240	541	18-1299	550
18-1005	498	18-1064	510	18-1123	515	18-1182	526	18-1241	541	18-1300	550
18-1006	498	18-1065	510	18-1124	515	18-1183	526	18-1242	541	18-1301	550
18-1007	498	18-1066	510	18-1125	515	18-1184	527	18-1243	542	18-1302	550
18-1008	499	18-1067	510	18-1126	515	18-1185	527	18-1244	542	18-1303	551
18-1009	499	18-1068	510	18-1127	516	18-1186	528	18-1245	542	18-1304	551
18-1010	499	18-1069	510	18-1128	516	18-1187	528	18-1246	542	18-1305	551
18-1011	499	18-1070	510	18-1129	516	18-1188	528	18-1247	542	18-1306	551

18-1307	552	19-1048	557	19-1107	562
18-1308	552	19-1049	557	19-1108	562
18-1309	552	19-1050	557	19-1109	562
18-1310	552	19-1051	557	19-1110	562
18-1311	552	19-1052	557	19-1111	562
18-1312	552	19-1053	557	19-1112	562
18-1313	552	19-1054	557	19-1113	562
18-1314	552	19-1055	557	19-1114	562
18-1315	553	19-1056	557	19-1115	562
18-1316	553	19-1057	557	19-1116	562
18-1317	553	19-1058	558	19-1117	562
18-1318	553	19-1059	558	19-1118	563
19-1001	554	19-1060	558	19-1119	563
19-1002	554	19-1061	559	19-1120	563
19-1003	554	19-1062	559	19-1121	563
19-1004	554	19-1063	559	19-1122	563
19-1005	554	19-1064	559	19-1123	563
19-1006	554	19-1065	560	19-1124	563
19-1007	554	19-1066	560	19-1125	563
19-1008	554	19-1067	560	19-1126	563
19-1009	554	19-1068	560	19-1127	563
19-1010	554	19-1069	560	19-1128	563
19-1011	554	19-1070	560	19-1129	563
19-1012	554	19-1071	560	19-1130	563
19-1013	554	19-1072	560	19-1131	563
19-1014	554	19-1073	560	19-1132	563
19-1015	554	19-1074	560	19-1133	563
19-1016	554	19-1075	560	19-1134	563
19-1017	554	19-1076	560	19-1135	563
19-1018	554	19-1077	560	19-1136	563
19-1019	554	19-1078	560	19-1137	563
19-1020	554	19-1079	560	19-1138	563
19-1021	554	19-1080	560	19-1139	563
19-1022	554	19-1081	560	19-1140	563
19-1023	554	19-1082	560	19-1141	563
19-1024	554	19-1083	561	19-1142	563
19-1025	555	19-1084	561	19-1143	563
19-1026	555	19-1085	561	19-1144	563
19-1027	555	19-1086	561	19-1145	564
19-1028	555	19-1087	561	19-1146	564
19-1029	555	19-1088	561	19-1147	564
19-1030	555	19-1089	562	19-1148	564
19-1031	555	19-1090	562	19-1149	564
19-1032	555	19-1091	562	19-1150	564
19-1033	555	19-1092	562	19-1151	564
19-1034	555	19-1093	562	19-1152	564
19-1035	556	19-1094	562		
19-1036	556	19-1095	562		
19-1037	556	19-1096	562		
19-1038	556	19-1097	562		
19-1039	556	19-1098	562		
19-1040	556	19-1099	562		
19-1041	556	19-1100	562		
19-1042	557	19-1101	562		
19-1043	557	19-1102	562		
19-1044	557	19-1103	562		
19-1045	557	19-1104	562		
19-1046	557	19-1105	562		
19-1047	557	19-1106	562		



TUSK INTERNATIONAL

Address: 24/477Gawshala Circular Road, Sialkot 51310-Pakistan

Tel# +92-52-4570160

Fax # +92-52-4570160

Cell # +92-321-6167087

Website: <http://www.tuskint.com>

E-Mail:sales@tuskint.com / info@tuskint.com